

# DISSOLUTION

---

And drug release



# Introduction

- When a new solid dosage form is developed, it is very important to study **drug release or dissolution**.
- To study release we need a mathematical method
- The mathematical modeling helps to optimize the design of new dosage form
- different mathematical models used to describe different drug release
- Examples zero order, first order, Hixson-Crowell, Higuchi,

# dosage forms that can be characterized by release in vitro

1. Solid oral dosage forms
2. Rectal dosage forms such as suppositories
3. Pulmonary (lung delivery) dosage forms (orally inhaled products)
4. Modified-release dosage forms
5. Semisolid products such as ointments, creams, and transdermal products.



# Drug dissolution

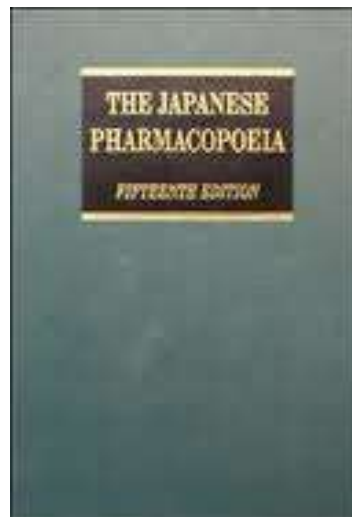
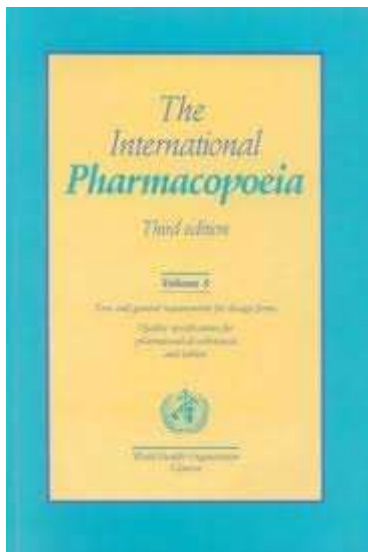
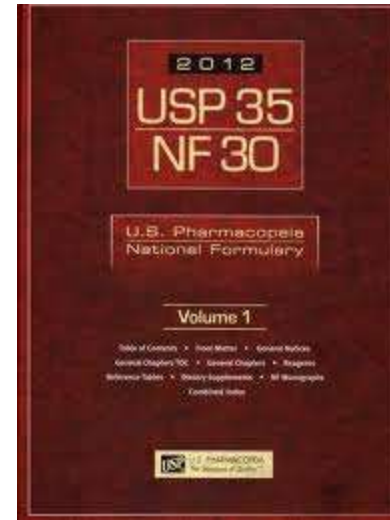

# Definitions

- **Drug Release:** Drug release is the **process by which a drug leaves a drug product** and is subjected to absorption, distribution, metabolism, and excretion, eventually becoming available for pharmacologic action

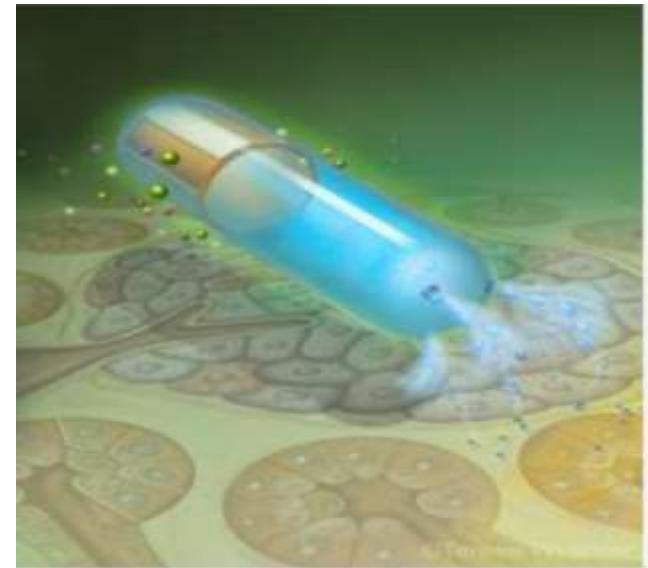
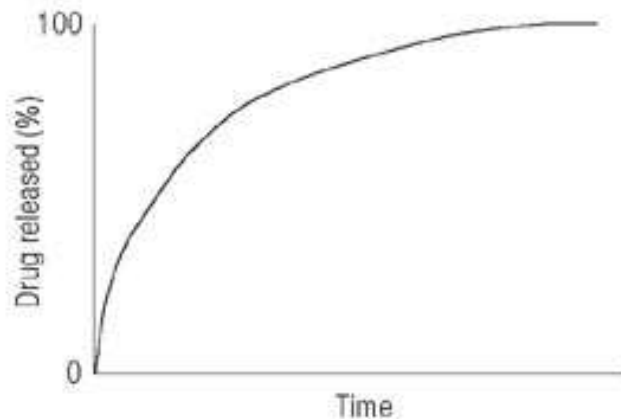
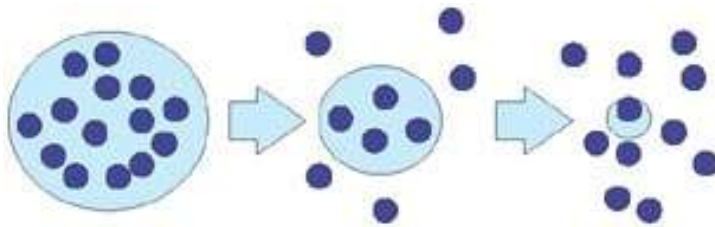

# Drug release is described in several ways.

- **Immediate release** refers to the **instantaneous availability of drug for absorption** or pharmacologic action. Immediate release drug products allow drugs to dissolve with no intention of delaying or prolonging dissolution or absorption of the drug.



- **Modified-release** dosage forms include both **delayed** and **extended-release** drug products.
- **Delayed release** is defined as the release of a drug at a time other than immediately following administration.

The United States Pharmacopeia (USP) defines **delayed-release** tablets as enteric-coated to **delay release** of the **medication** until the tablet has passed through the stomach to prevent the **drug from** being destroyed or inactivated by gastric juices or where it may irritate the gastric mucosa.

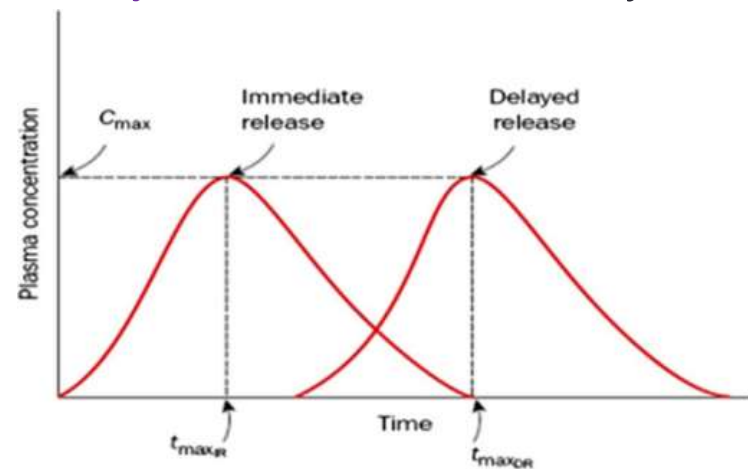

- Enteric Coated: Intended to delay the release of the drug (or drugs) until the dosage form has passed through the stomach. Enteric-coated products are delayed-release dosage forms.

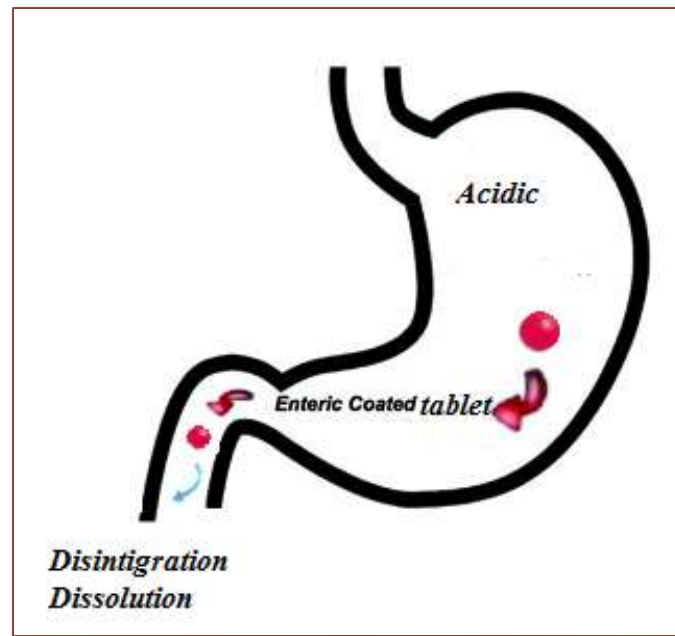



- Extended-release products are formulated to make the drug available over an extended period after administration.

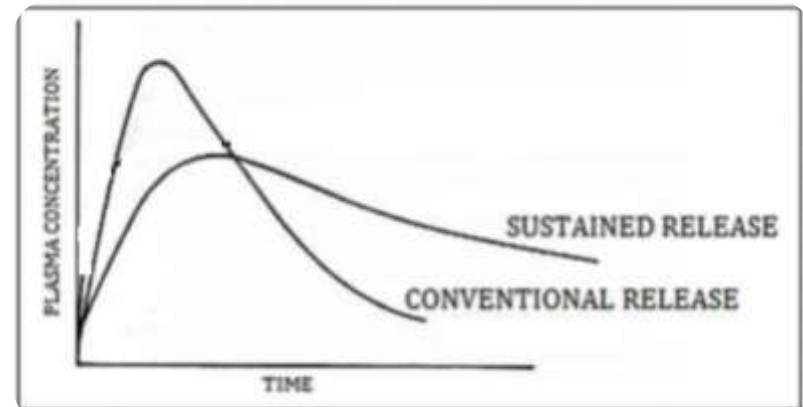

- Increase time in therapeutic window

- **controlled release** includes **extended-release** and **pulsatile-release** products.
- Pulsatile release involves the release of **limited** amounts (or pulses) of drug at distinct time intervals that are programmed into the drug product.
- Advantage : •Body function that follow circadian rhythms

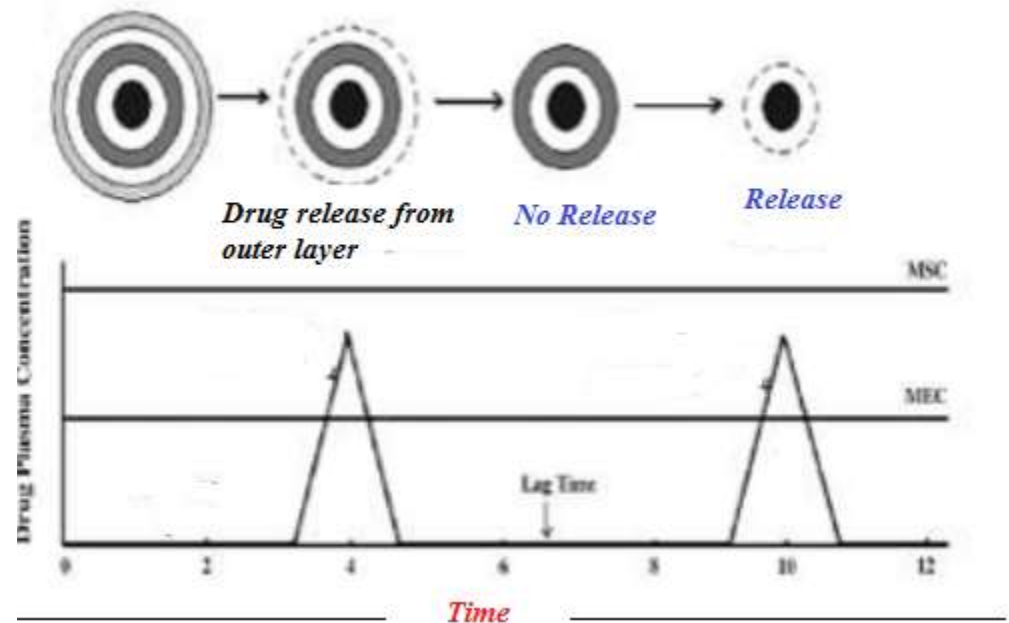
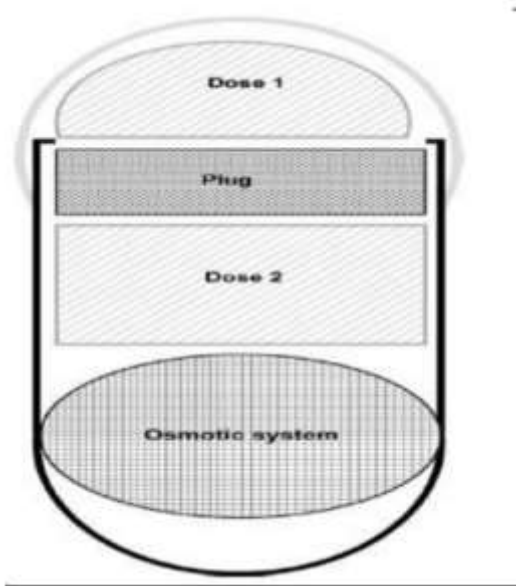

# Dissolution

- Dissolution: the process by which a solid phase (e.g., a tablet or powder) goes into a solution phase such as water.
- only drugs in solution can be absorbed, distributed, metabolized, excreted, or even exert pharmacologic action. Thus, dissolution is an important process in the pharmaceutical sciences.

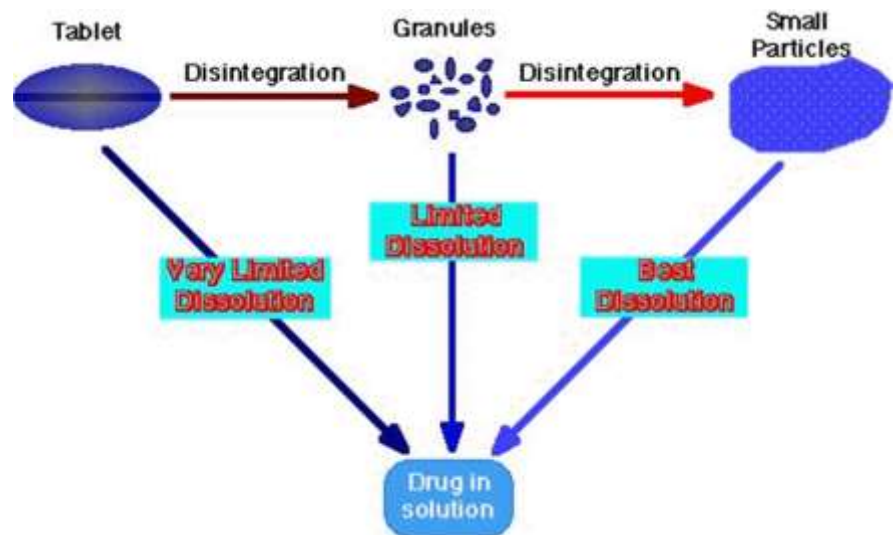

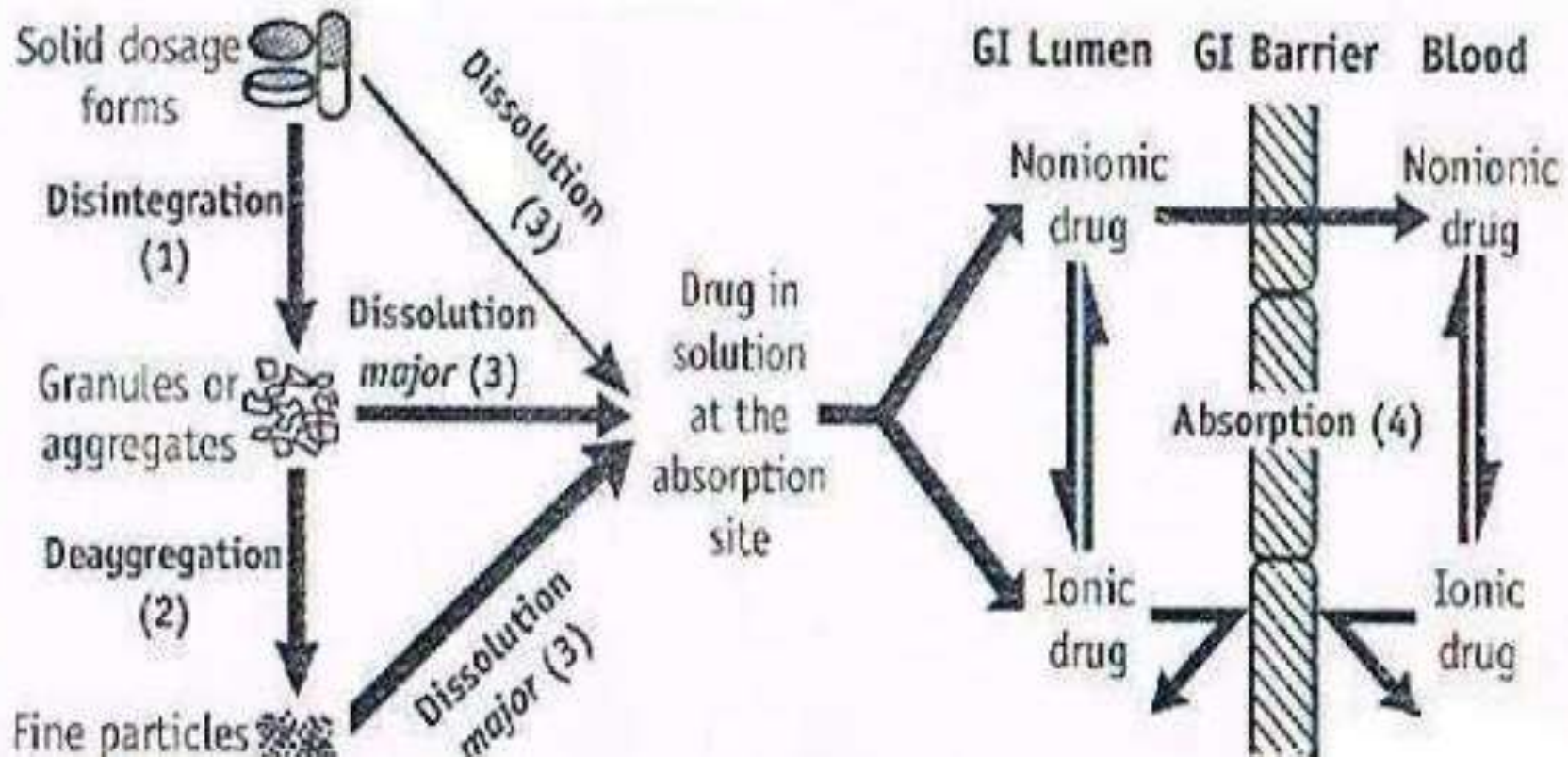



# Terminology

- **Drug Product:** A drug product is a finished dosage form (e.g., tablet and capsule) that contains a drug substance, generally, but not necessarily in association with one or more other ingredients
- **A solid oral dosage** form includes but is not limited to tablets, chewable tablets, enteric-coated tablets, capsules, caplets and gelcaps
- **Drug Substance:** An active ingredient that is intended to furnish pharmacologic activity or other direct effect in the diagnosis, cure, mitigation (reduce severity) or prevention of a disease,

- **In Vitro–in Vivo Correlation:** A predictive mathematical model describing the relationship between an **in vitro property of an oral dosage form** (usually the rate or extent of drug dissolution or release) and a **relevant in vivo response** (e.g., plasma drug concentration or amount of drug absorbed).

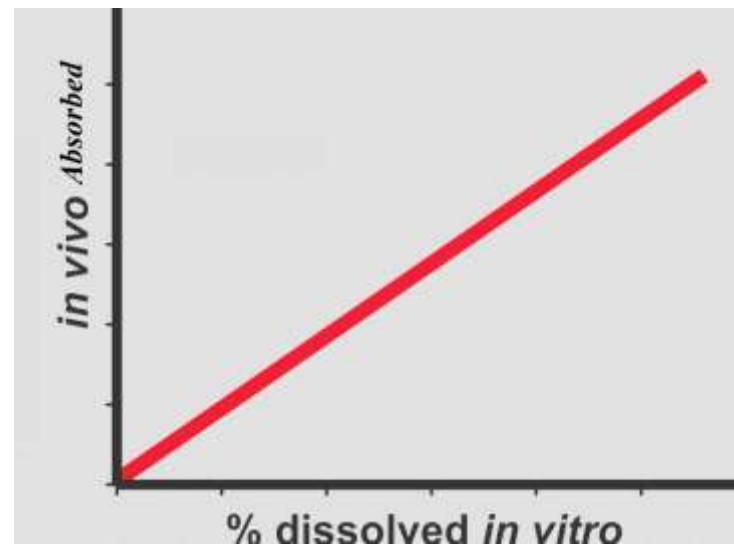

## Plasma concentration time profile (Sustained Release Drug)

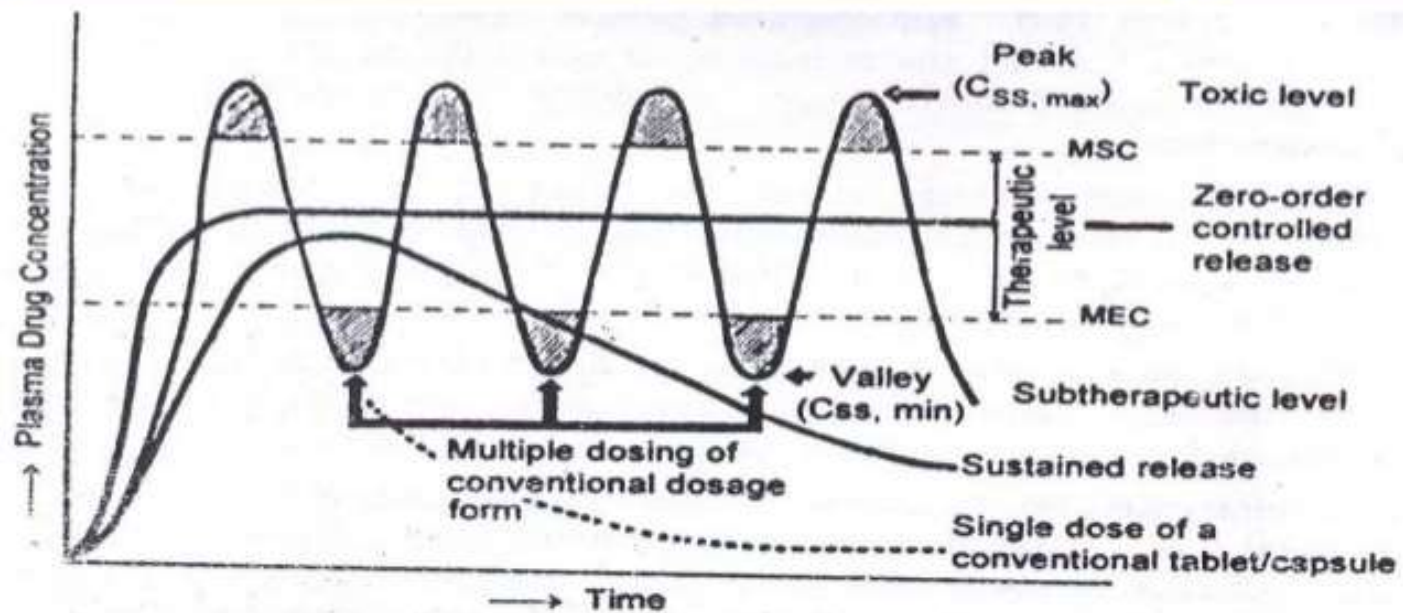



# Why dissolution testing

- Dissolution tests are used for many purposes in the pharmaceutical industry
- development of new products
- quality control
- assist with the determination of bioequivalence (similar bioavailability)
- Postapproval changes and introduced the possibility of substituting dissolution tests for clinical studies in some cases (In vivo in vitro correlation)

## Conditions that May Affect Drug Dissolution and Release: Drug and formulation related

- Drug substance
  - Particle size
  - Polymorph
  - Surface area
  - Chemical stability in dissolution media
- Formulation of drug product
  - Excipients (lubricants, suspending agents, etc)

# Conditions that May Affect Drug Dissolution and Release: methodology related

- Medium
  - Volume
  - pH
  - Co-solvents, added enzymes/surfactants
- Temperature of medium
- Apparatus
- Hydrodynamics
  - Agitation rate
  - Shape of dissolution vessel
  - Placement of tablet in vessel
  - Sinkers (for floating products and products that stick to side of vessel)



# Dissolution Apparatus

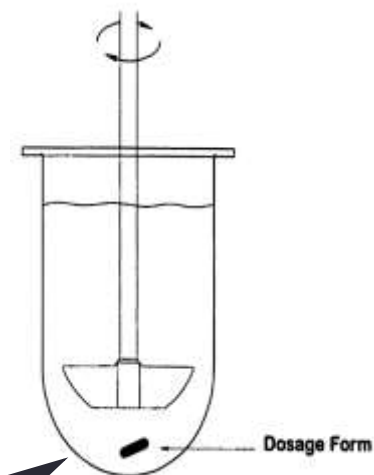

# Dissolution Apparatus

Apparatus <sup>a</sup>	Name	Drug Product
Apparatus 1	Rotating basket	Tablets, capsules , suppositories, floaters, controlled release
Apparatus 2	Paddle	Tablets, capsules, modified drug products,
Apparatus 3	Reciprocating cylinder	Extended-release drug products
Apparatus 4	Flow cell	Drug products containing low-water-soluble drugs
Apparatus 5	Paddle over disk	Transdermal drug products
Apparatus 6	Cylinder	Transdermal drug products
Apparatus 7	Reciprocating disk	Transdermal drug products
Diffusion cell (Franz)		Ointments, creams, transdermal drug products

<sup>a</sup>Apparatus 1–7 refer to compendial dissolution apparatus in USP-NF (United States Pharmacopeia)

# Rotating basket (Apparatus 1)

It is inferior for testing dosage forms which contains gums due to clogging of screen matrix

In the case of floating dosage forms this method performs well, but care should be taken that excipients do not clog the basket mesh

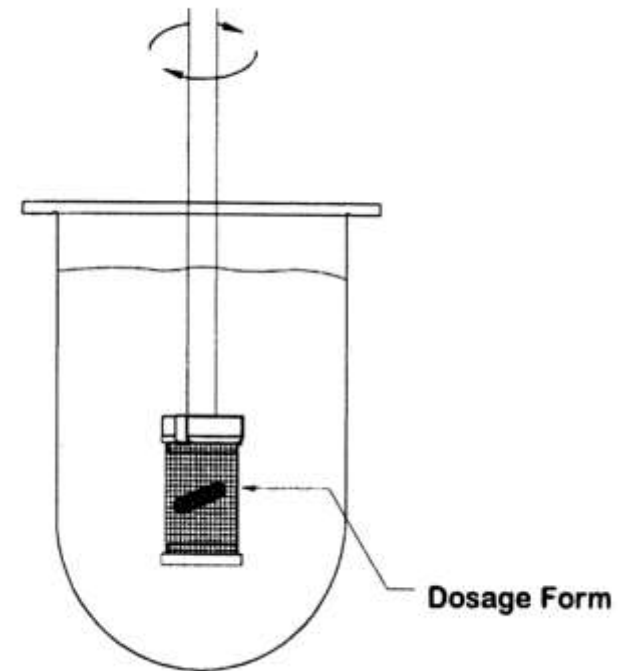

# Rotating Paddle (Apparatus 2)

This apparatus is identical to apparatus 1 except that the paddle is substituted for the rotating basket

Frequently used for both disintegrating and non-disintegrating dosage forms

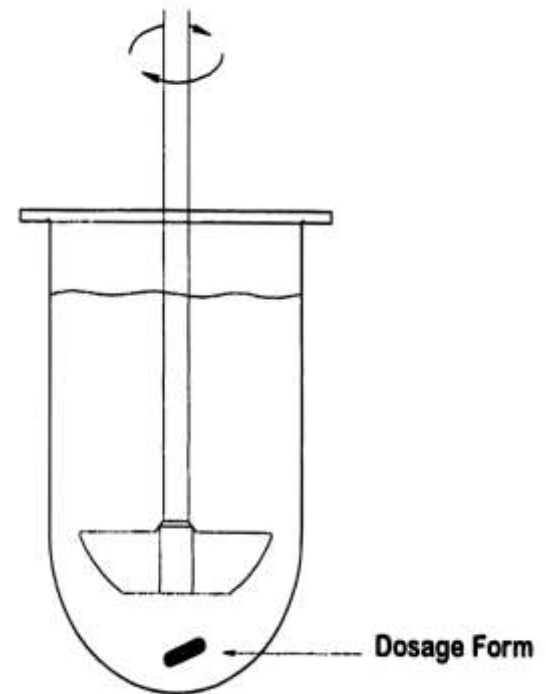

# Reciprocating cylinder (Apparatus 3)

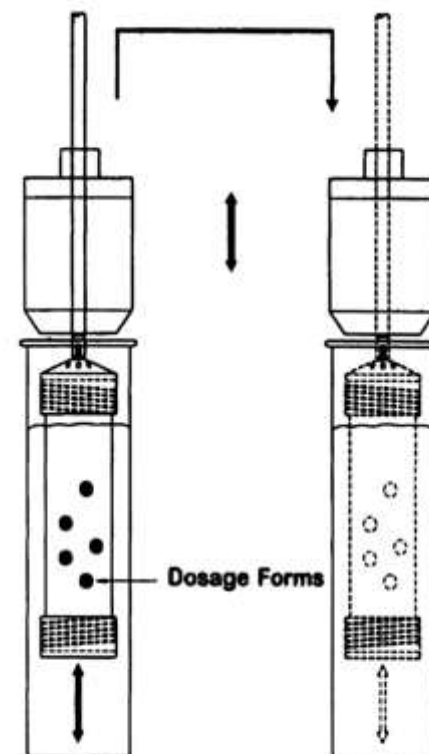



## Reciprocating cylinder (Apparatus 3)

- One advantage of the reciprocating cylinder is that the gastrointestinal tract conditions can be easily simulated, as it is easy to make time dependent pH changes
- This apparatus is most suitable for nondisintegrating (extended release) or delayed release (enteric coated) dosage forms

# Flow cell (Apparatus 4)

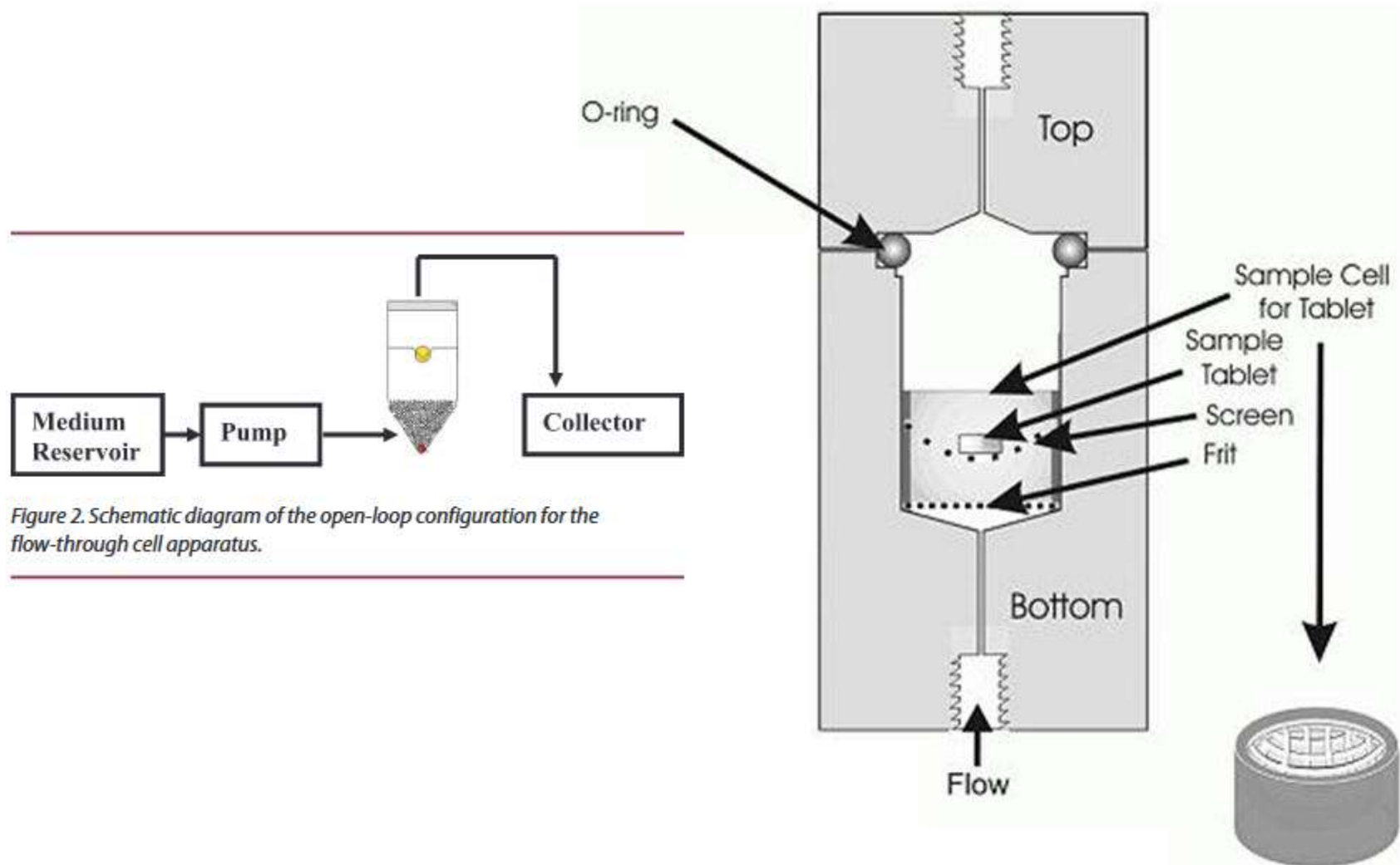

# Flow cell (Apparatus 4)

- The advantage of flow through cell apparatus is the ability to test drugs of very low aqueous solubility and the ability to change the pH conveniently during the test

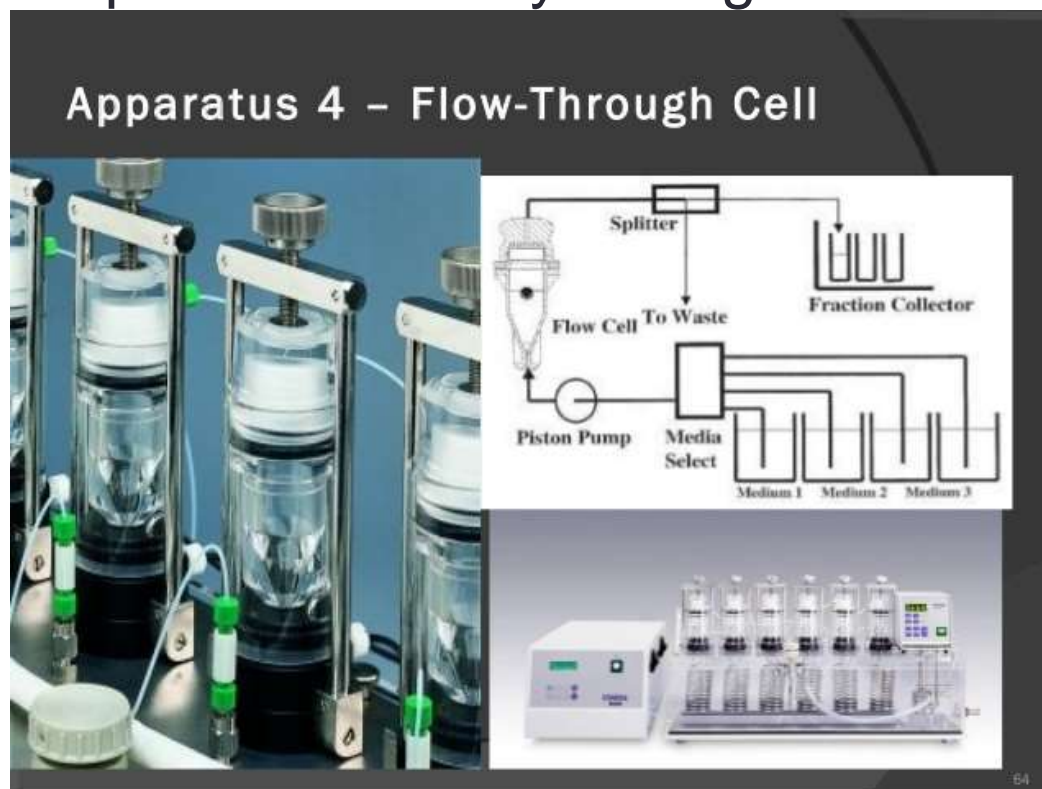

# Paddle over disk (Apparatus 5)

Standard Paddle Used  
 ■ Typical Volume 900 mL  
 ■ Temperature 32 °C

Useful for  
 ■ Transdermal Patches

Modifications  
 ■ Disk Design  
 ■ Volume

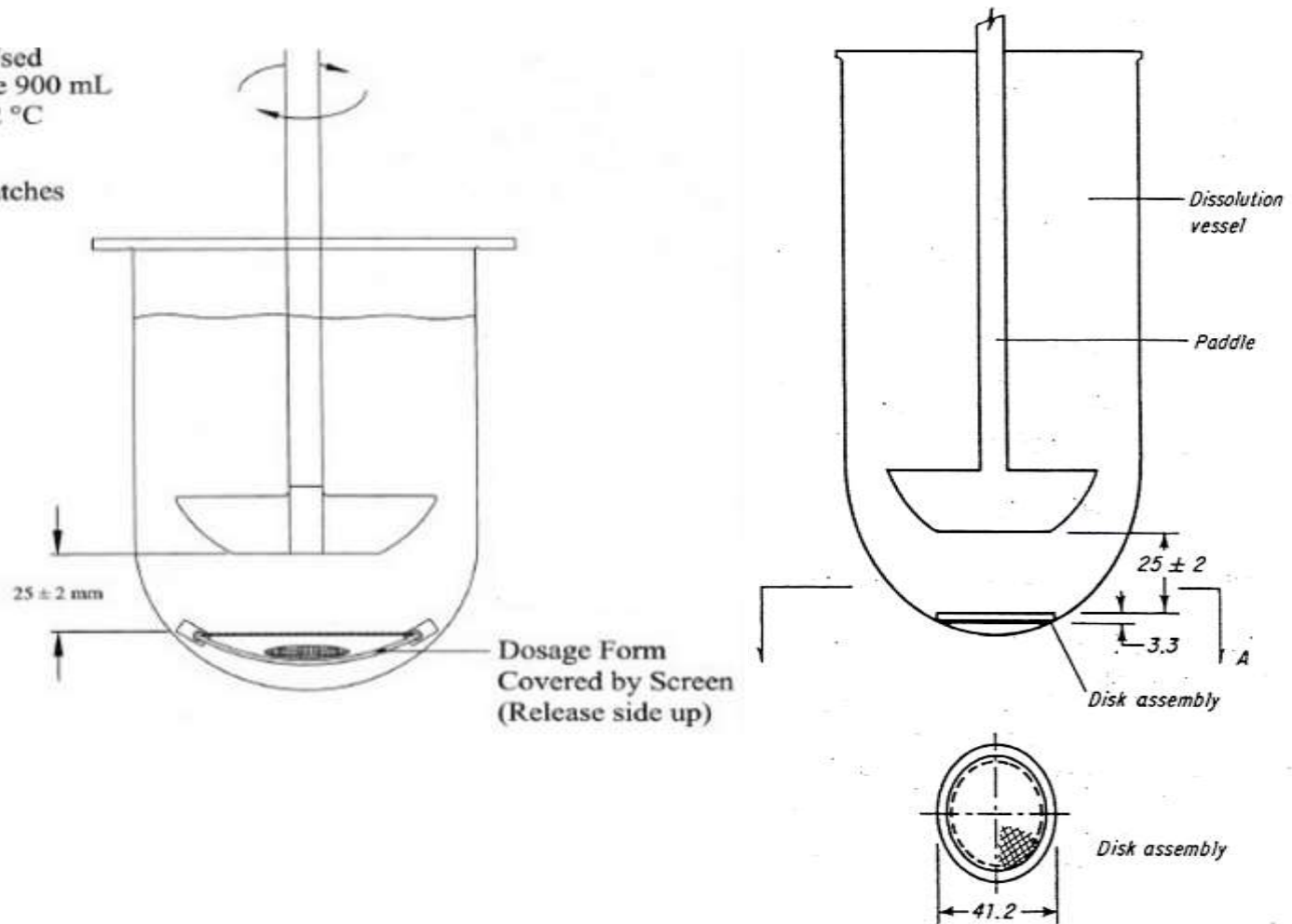

# Cylinder (Apparatus 6)

- The cylinder method (Apparatus 6) for testing transdermal preparation is modified from the basket method (Apparatus 1). In place of the basket, a stainless steel cylinder is used to hold the sample.
- Release side out
- Adhesive is used
- Transdermal patch

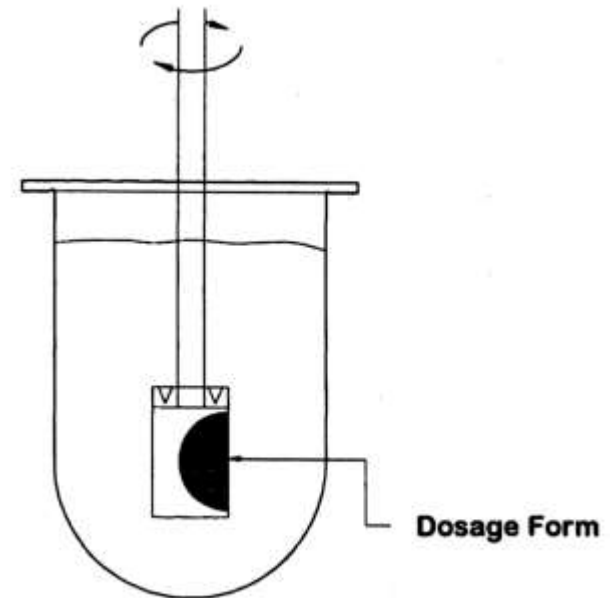

# Reciprocating Disk Method (Apparatus 7)

- In the reciprocating disk method for testing transdermal products, a motor drive assembly (Apparatus 7) is used to reciprocate the system vertically, and the samples are placed on disk-shaped
- Adhesive needed
- transdermal



**Reciprocating Disk**

# Advantages of controlled drug delivery

- Reduce dose frequency
- Reduce fluctuations in circulating drug levels
- Increase patient compliance
- Avoidance of night dosing
- More uniform drug release
- Avoidance of GI irritation and GI side effects
- Mimic circadian rhythm

# Mechanism aspects of controlled Oral drug delivery formulation

- 1. Dissolution controlled systems:**
- 2. Diffusion controlled systems**
- 3. Combination of both dissolution & diffusion.**
- 4. Osmotic pressure controlled system**



# Controlled Release Systems

## Dissolution controlled systems

- In dissolution controlled systems, the rate controlling step is dissolution.
- The drug is embedded in slowly dissolving or erodible matrix

Matrix dissolution controlled system

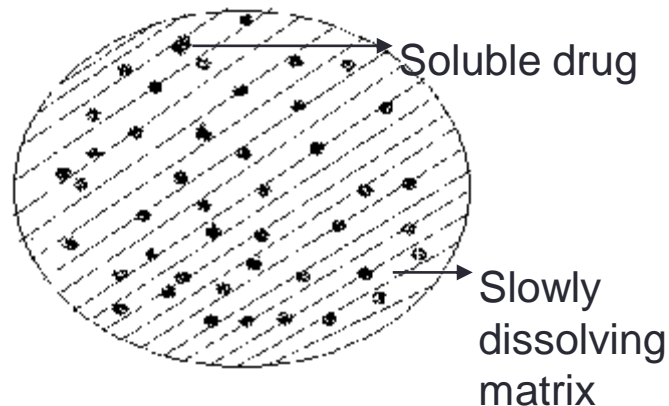

# Controlled Release Systems

## Diffusion controlled systems

- Diffusion systems are characterized by release rate of drug is dependent on its diffusion through inert water insoluble membrane barrier.
- There are basically two types of diffusion devices.

(I) Reservoir devices

(II) Matrix devices

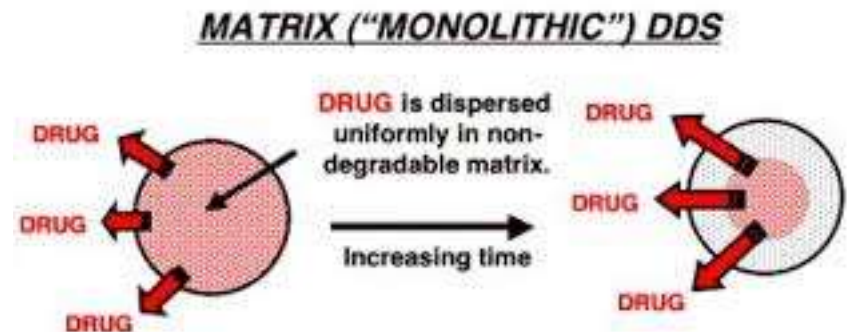
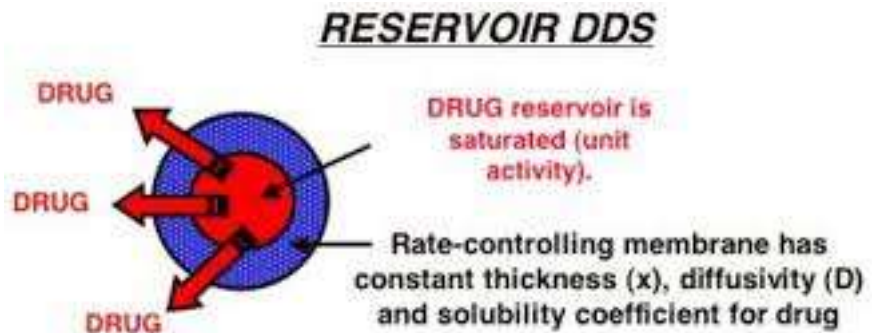

# Controlled Release Systems

## Dissolution & Diffusion Controlled Release system

- Drug encased in a partially soluble membrane.
- Pores are created due to dissolution of parts of membrane.
- It permits entry of aqueous medium into core & drug dissolution.
- Diffusion of dissolved drug out of system.

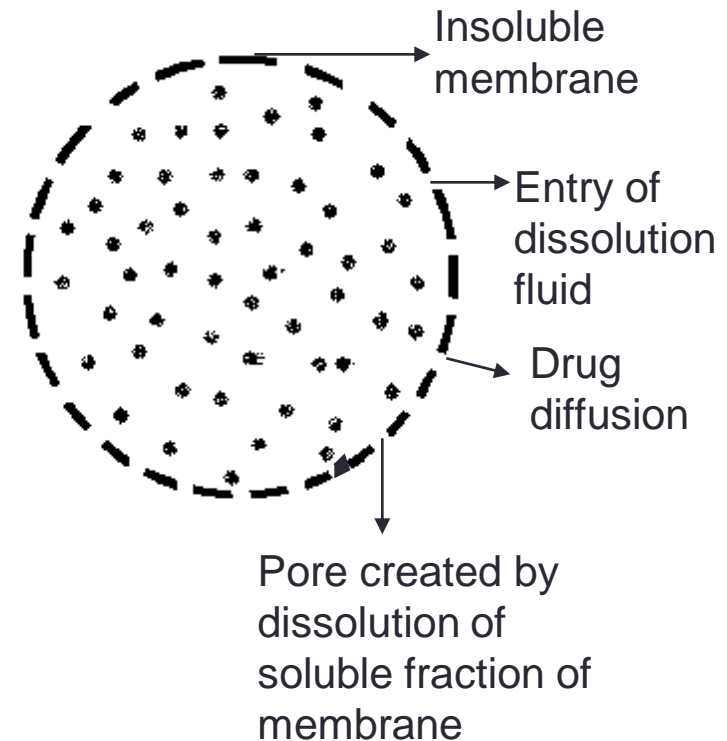

# Controlled Release Systems

- **Osmotic pressure controlled system**

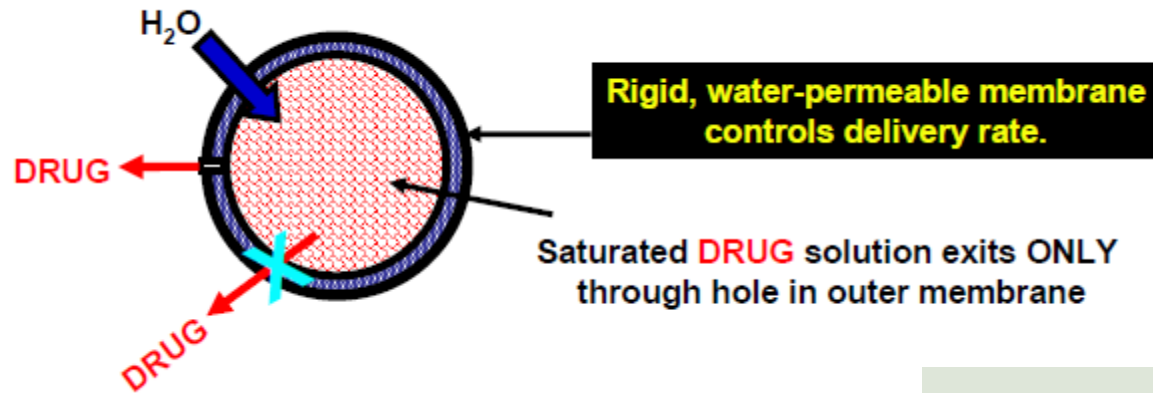

*Osmosis* is the spontaneous net movement of solvent molecules through a semi-permeable membrane into a region of higher solute concentration

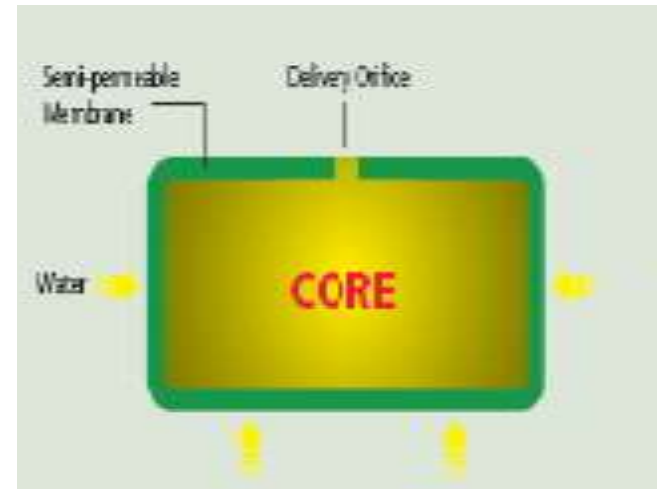

# Zero order and first order release

- Drug dissolution and release patterns commonly fall into two groups: zero- and first-order release
- zero-order release is achieved from **no disintegrating dosage forms** such as topical or transdermal delivery systems, implantable, oral controlled release delivery systems
- Same amount of drug release per unit time

DRUG RELEASE RATE

• INDEPENDENT OF CONCENTRATION.

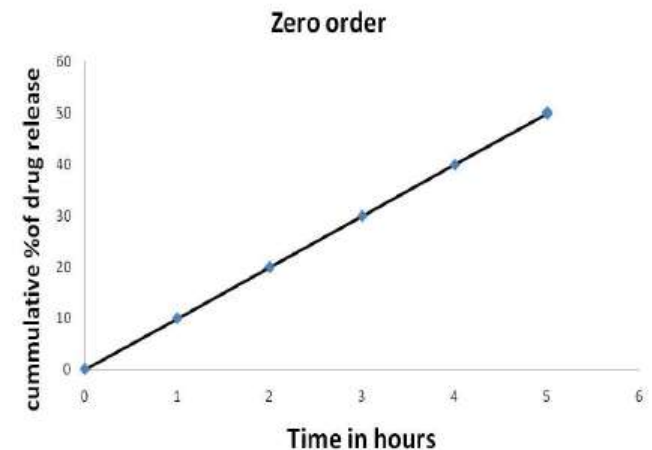

# Example (zero order kinetics)

- A patient was **given 100 mg** of drug **A** orally. Assume that the drug absorption **follows zero-order** kinetics at a rate of 10 mg/min. .
- Then can you predict the drug absorption at every minute **!!!!**
- **For every minute, 10 mg of the drug will undergo absorption.**
- So after 5 minutes, how much will be absorbed?
- 5 x 10 mg = 50 mg will be absorbed.
- Similarly 80 mg will be absorbed after 8 minutes.
- By what time the whole drug will be absorbed?
- it will take 10 minutes for complete absorption of drug and the process comes to an end.
  
- If the administered dose of the same drug is 200 mg, again the same rate, 10 mg/min will be followed and the process comes to an end **after 20 mins.**

# Zero order release

- Zero-order release kinetics refers to the process of constant drug release from a drug delivery device such as **oral osmotic tablets, transdermal systems, matrix tablets**
- “Constant” release is defined in this context as the **same**
- **amount of drug release per unit of time.**

$$Q=Q_0+K_0t$$

- $Q$  is the amount of drug released or dissolved (assuming that release occurs rapidly after the drug dissolves),
- $Q_0$  is the initial amount of drug in solution (it is usually zero)
- $K_0$  is the zero-order release constant.

- In Fickian diffusion, the rate of **release** is independent of the drug concentration in the system and considered a zero order release model

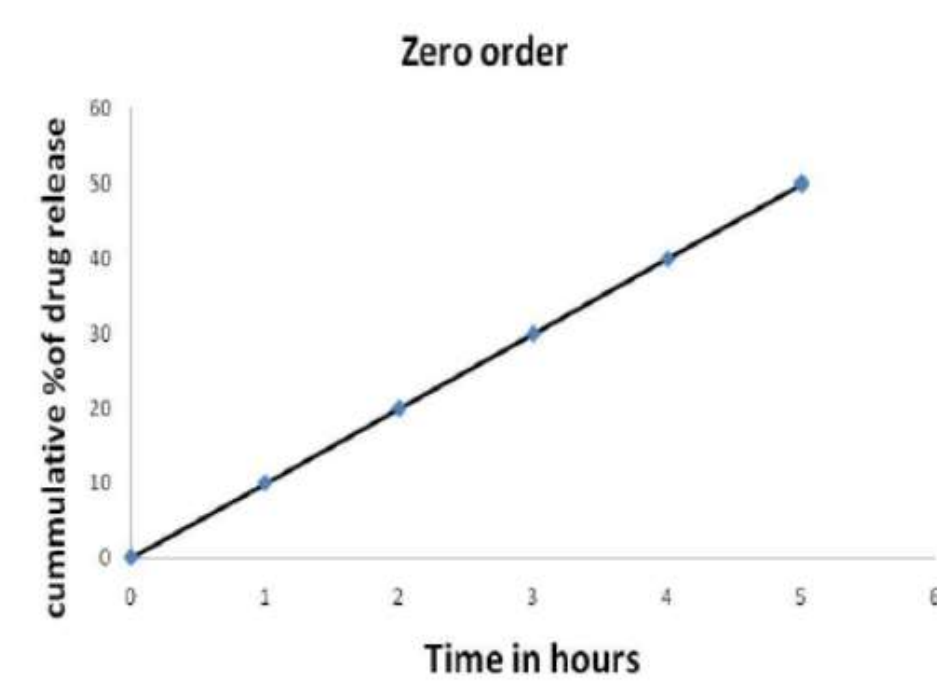



# Example on zero order release

- release from polymer matrix composed of HPMC: NaCMC
- HPMC: Na CMC was 1:0.25:2.25 for **Propranolol** hydrochloride,
- 1:1.25:1.25 for **Metoprolol tartrate**
- 1:2.08:2.92 for **Alprenolol hydrochloride**,
- total drug is released in about 12 h at a nearly zero-order rate

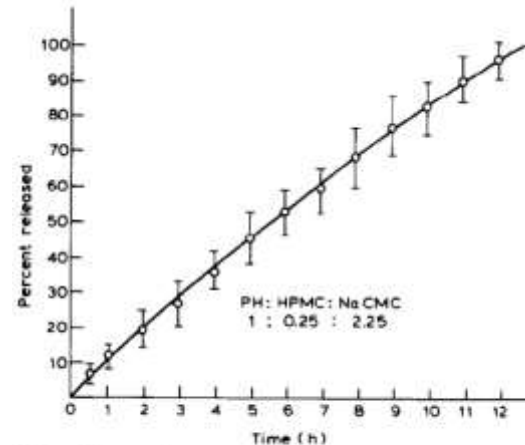
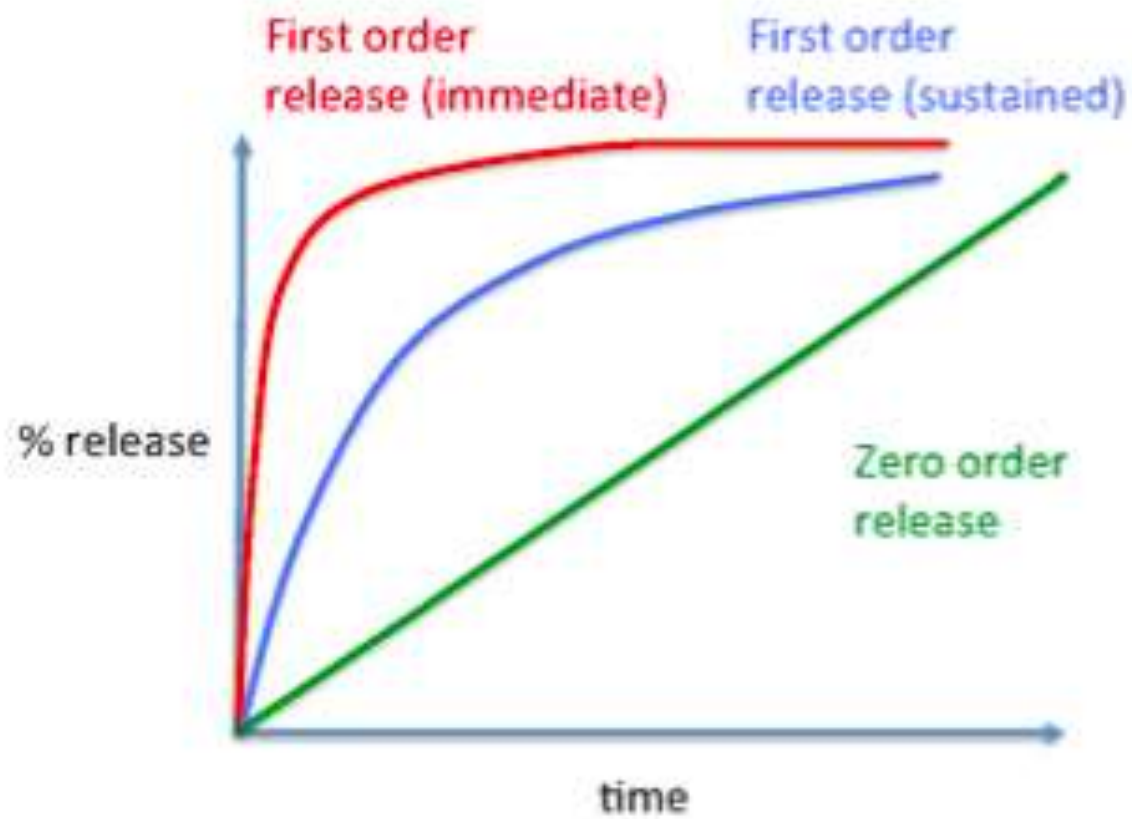

Fig. 7. Release of propranolol hydrochloride (cumulative percent) as a function of time from tablets of different batches ( $n = 10$ ). Vertical bars indicate  $\pm$  S.D.

# First order release kinetics

- **The drug release is dependent on drug concentration**
- Let us consider an example: A patient was given 100 mg of drug **B** orally and it was assumed to be following **first-order kinetics** a proportion of **10% per minute**, of the existing concentration at that time is released
- So, in first minute 10% of initial drug (**10 mg**) will be released.
- In the second minute again 10% will be absorbed but here the drug remained for release after first minute is  $100 - 10 = 90$  mg only.
- So 10% of 90 mg will be released in the second minute (9 mg). So, at the end of second minute, 81 mg will remain
-



- The release is considered first order kinetics and can be represented by the following equation

$$\log Q_t = \log Q_0 - (Kt/2.303)$$

**Where**

**$Q_t$  : is the amount of drug remaining**

**$Q_0$  : is the initial amount of drug in the device**

**and  $K$  is the First-order release constant**

## FIRST ORDER

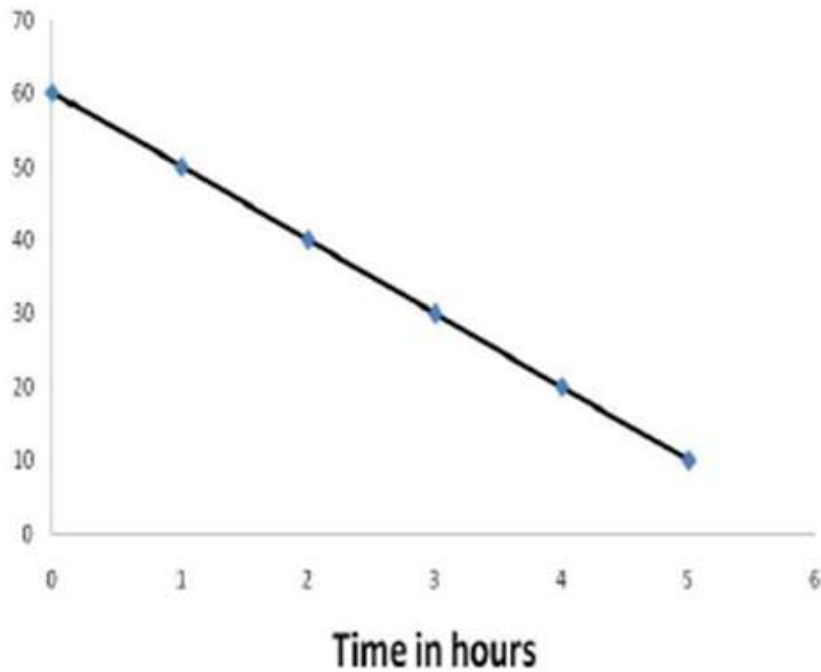

**DRUG RELEASE RATE**

- Depends on the concentration.

**GRAPHICAL REPRESENTATION**

- log of % drug remaining vs time

# Drug release kinetics (mathematical models)

- **Drug release kinetics:** is the application of mathematical models to study drug release process
- **Diffusion layer model**
- In dissolution it is assumed that an *aqueous diffusion layer or stagnant liquid film of thickness  $h$  exists at the surface of a solid undergoing dissolution*
- This thickness,  $h$ , represents a stationary layer of solvent in which the solute molecules exist in concentrations from  $C_s$  (highest concentration) to  $C$ .
- Beyond the static diffusion layer, *at  $x$  greater than  $h$ , mixing occurs in the solution, and the drug is found at a uniform concentration  $C$ , throughout the bulk phase*

# Mathematical model for drug dissolution

## Noyes Whitney equation

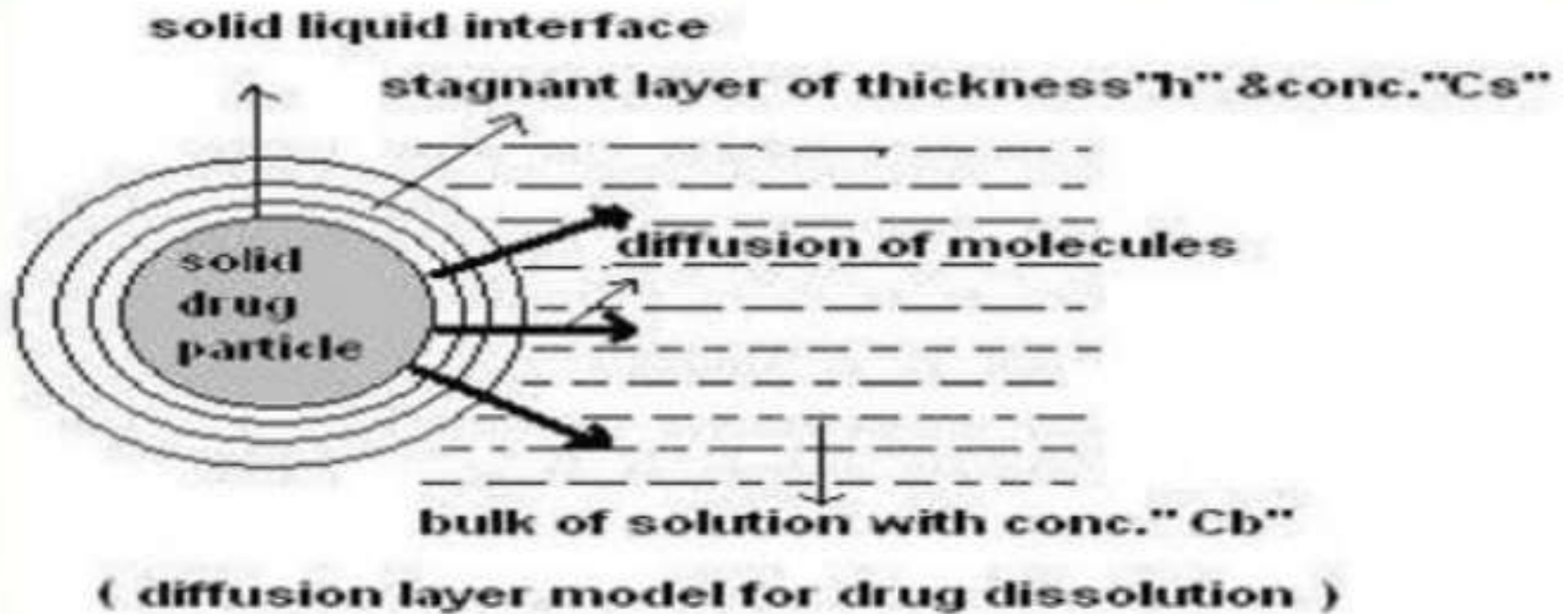

# Mathematical model for drug dissolution

## Noyes Whitney equation

- **the rate of dissolution:** reflects the amount of drug dissolved over a given time period.
- The rate at which a solid dissolves in a solvent was proposed in quantitative terms by Noyes and Whitney

- **M:** mass of solute dissolved
- **t:** time
- **dM/dt:** rate of mass dissolution
- **S:** surface area of exposed solid
- **h:** thickness of diffusion layer
- **$C_s$**  is the solubility of the solid

- (i.e., concentration of a saturated solution of the compound at the surface of the solid and at the temperature of the experiment)
- **C** is the concentration of solute in the bulk solution and at time *t*.
- **The  $dC/dt$**  is the dissolution rate,
- and **V** is the volume of solution.
- **D:** is the diffusion coefficient

$$\frac{dM}{dt} = \frac{DS}{h} (C_s - C)$$

$$\frac{dC}{dt} = \frac{DS}{Vh} (C_s - C)$$



- If dissolving solid surface area to be considered  
Then (Hixson and Crowell model)

$$\frac{dM}{dt} = KS(C_s - \bar{C})$$

$K=D/h$  D: diffusion coefficient

K: dissolution rate constant

- If sink conditions : then Noyes Whitney equation becomes  
 $dm/dt = KSC_s$

- In Noyes Whitney equation the driving force dissolution is the concentration gradient across the boundary layer, with thickness  $h$
- Sink conditions is considered when the concentration of dissolved drug is less than 20% of the saturation concentration ( $C_s$ )

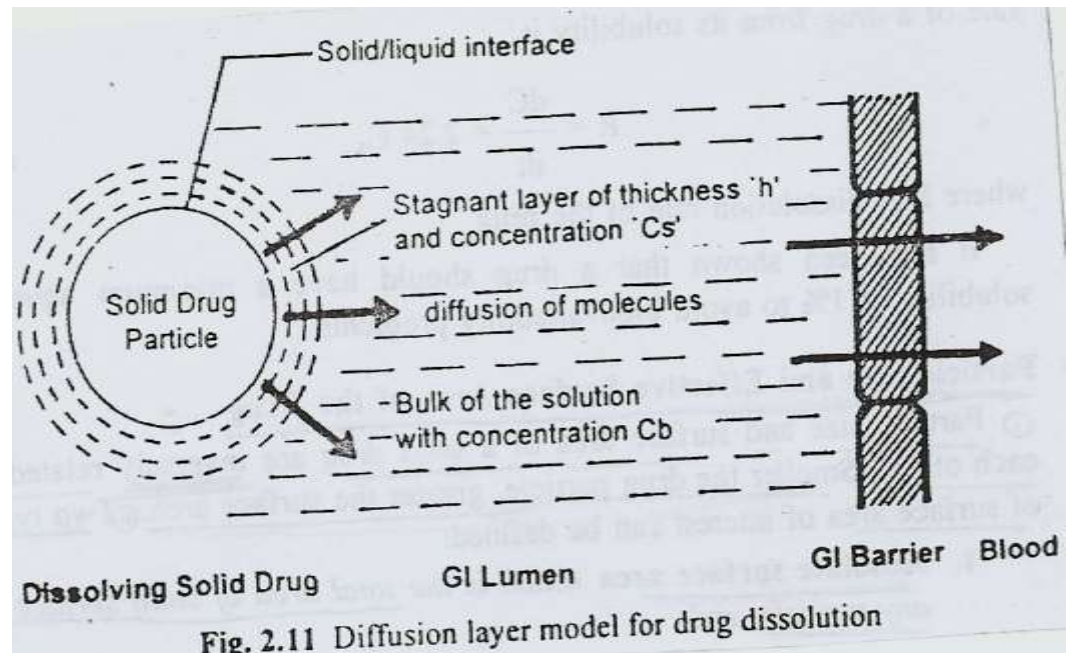

$$\frac{dM}{dt} = \frac{DS}{h}(C_s - C)$$

- **Calculate Dissolution Rate Constant**

- A preparation of drug granules having a total surface area of 0.28 m<sup>2</sup> (0.28 × 10<sup>4</sup> cm<sup>2</sup>) is allowed to dissolve in 500 mL of water at 25°C. After the first minute, 0.76 g has passed into solution.
- The quantity  $D/h$  can be referred to as a dissolution rate constant,  $k$ .
- If the solubility,  $C_s$ , of the drug is 15 mg/mL at 25 °C, what is  $k$ ? *From equation*

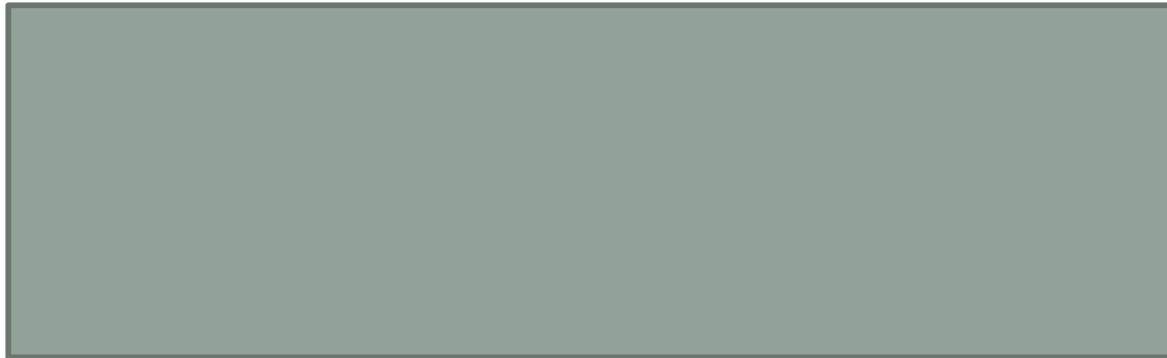

$$\frac{dM}{dt} = \frac{DS}{h}(C_s - C)$$

- In this example, 0.760 g dissolved in 500 mL after a time of 1 min, or 760 mg/500 mL = 1.5 mg/cm<sup>3</sup>. This
- value is one tenth of the drug's solubility (15 mg/mL )and can be omitted from equation **without introducing significant error,**
- shown by employing the full equation

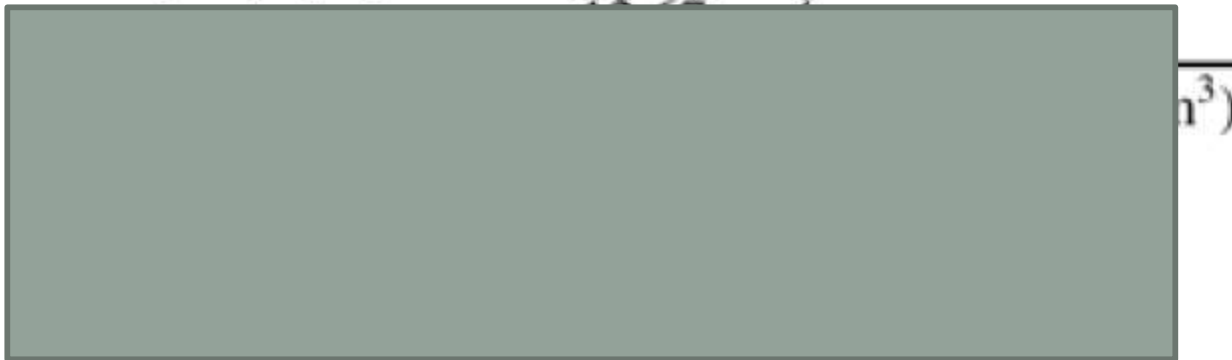

- Derivation of equations **Noyes-Whitney** it was assumed that *h and S were constant*

**But this is not the case.**

- The static diffusion layer thickness is altered by the force of agitation at the surface of the dissolving tablet
- The surface area, *S*, obviously does not remain constant as a powder, granule, or tablet dissolves, and it is difficult to obtain an accurate measure of *S* as the process continues.



# Mathematical model for drug dissolution

## Hixson-Crowell cube root equation

- Applies for dissolution of powder drugs:
- Assumptions:
  - Spherical particles.
  - Shape remains spherical during dissolution.
  - All particles have the same size. (uniform size)

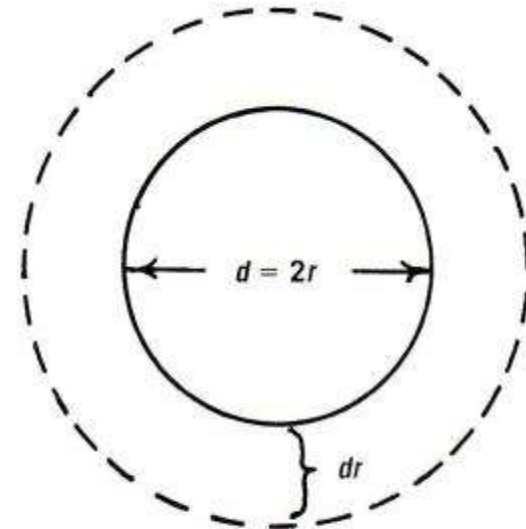

**Fig. 13–3.** Schematic of a particle, showing the change in surface area and volume as the particle dissolves. The volume,  $dV$ , dissolved in  $dt$  seconds is given by Thickness  $\times$  Surface area  $= dr \times 4\pi r^2$ . (After J. T. Carstensen, *Pharmaceutics of Solids and Solid Dosage Forms*, Wiley, New York, 1977, p. 75. With permission.)

# Mathematical model for drug dissolution

## Hixson-Crowell cube root equation

$M_0$ : original mass of drug particles

$M_t$ : mass of drug particles remaining at time  $t$

$K$ : cube root dissolution constant

$k' = D/h$

$$M_0^{\frac{1}{3}} - M_t^{\frac{1}{3}} = kt$$

$$k = \frac{M_0^{\frac{1}{3}}}{d} \frac{2k'Cs}{\rho}$$

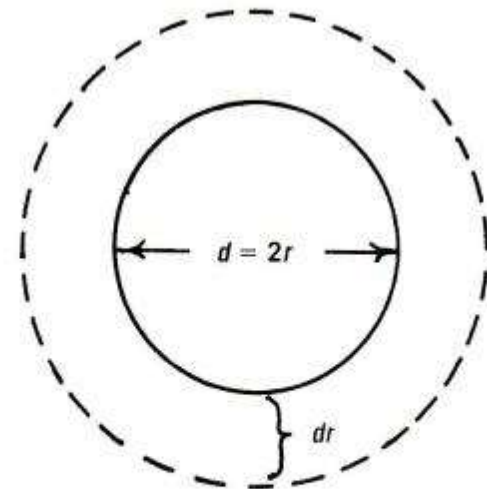

**Fig. 13-3.** Schematic of a particle, showing the change in surface area and volume as the particle dissolves. The volume,  $dV$ , dissolved in  $dt$  seconds is given by Thickness  $\times$  Surface area  $= dr \times 4\pi r^2$ . (After J. T. Carstensen, *Pharmaceutics of Solids and Solid Dosage Forms*, Wiley, New York, 1977, p. 75. With permission.)

- Sink conditions is assumed
- in the derivation

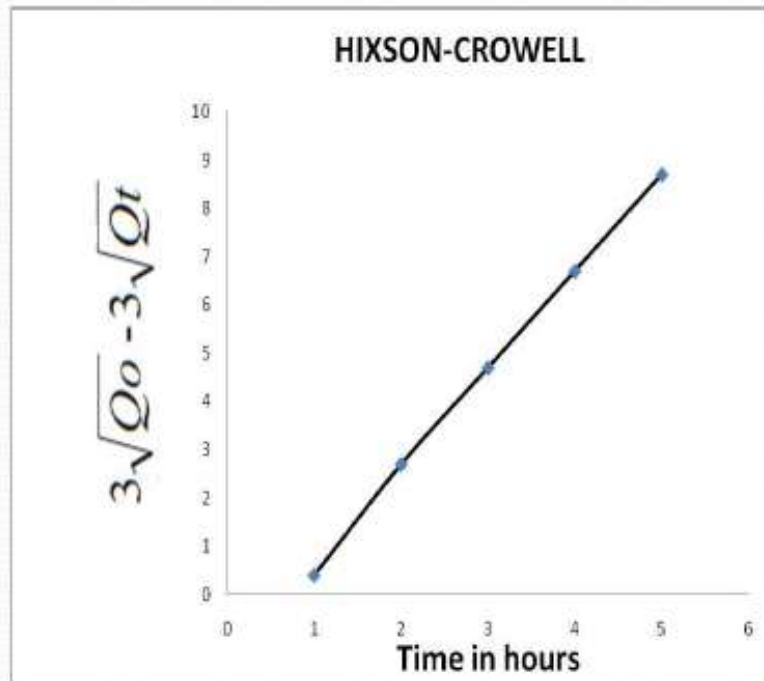



$r$  radius and surface area  $4\pi r^2$  and  $V = \frac{4}{3}\pi r^3$   
 if the radius is reduced by  $dr$ , the volume change is

$$dV = 4\pi r^2 dr \quad \text{For } N \text{ particles} \quad dV = 4N\pi r^2 dr$$

The surface area of  $N$  particles is  $S = 4N\pi r^2$   
 the infinitesimal mass change Noyes–Whitney law,

$$-dM = KSCsdt$$

drug's density multiplied by the infinitesimal volume change,  $\rho dV$ , can be set equal to  $dM$

$$-\rho dV = KSCsdt \quad \text{Substituted } S \text{ and } dV \quad -4\rho N\pi r^2 dr = 4N\pi r^2 KCsdt$$

$$-\rho dr = KCsdt \quad \text{Integration} \quad -\int_{r_0}^r dr = \int_0^t \frac{KCs}{\rho} dt \quad \longrightarrow \quad r = r_0 - \frac{KCs}{\rho} t$$

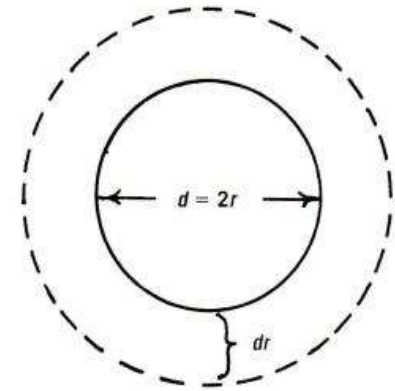

**Fig. 13-3.** Schematic of a particle, showing the change in surface area and volume as the particle dissolves. The volume,  $dV$ , dissolved in  $dt$  seconds is given by Thickness  $\times$  Surface area  $= dr \times 4\pi r^2$ . (After J. T. Carstensen, *Pharmaceutics of Solids and Solid Dosage Forms*, Wiley, New York, 1977, p. 75. With permission.)

$$r = r_0 - \frac{KC_s}{\rho} t \quad \text{Equations 1}$$

Volume of a spherical particle  $V = \frac{1}{6} \pi d^3$   Mass for N particles  $M = N r \frac{\rho}{6} d^3$

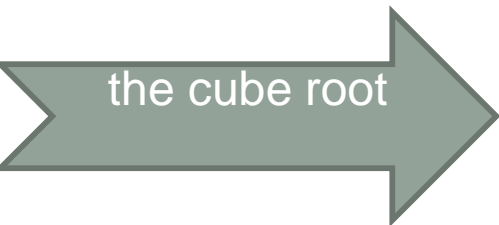
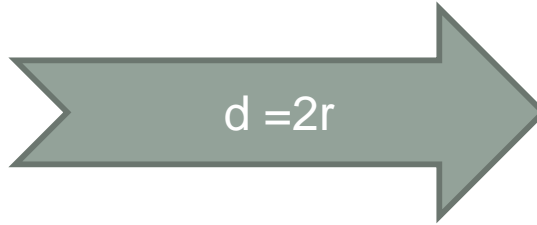
 the cube root  $M^{\frac{1}{3}} = \left[ N \rho \left( \frac{\pi}{6} \right) \right]^{\frac{1}{3}} d$    $d = 2r$

$$M_0^{\frac{1}{3}} - M_t^{\frac{1}{3}} = \left[ N \rho \left( \frac{\pi}{6} \right) \right]^{\frac{1}{3}} \left[ \frac{2kC_s t}{\rho} \right] = \kappa t$$

$$M_0^{\frac{1}{3}} - M_t^{\frac{1}{3}} = \kappa t$$

$$\kappa = \left[ N \rho \left( \frac{\pi}{6} \right) \right]^{\frac{1}{3}} \frac{2kC_s}{\rho} = \frac{M_0^{\frac{1}{3}}}{d} \frac{2kC_s}{\rho}$$

## Example (1)

$$M_0^{\frac{1}{3}} - M_t^{\frac{1}{3}} = kt$$

A specially prepared tolbutamide powder of fairly uniformly sized particles with a diameter of 150  $\mu\text{m}$  weighed **75 mg**. Dissolution of the drug was determined in **1000 mL** of water at 25°C as a function of time. Determine the value of  $\kappa$ , the cube-root dissolution rate constant, at each time interval and calculate the average value of  $\kappa$ .

### DISSOLUTION OF TOLBUTAMIDE POWDER\*

Time (min)	Concentration Dissolved (mg/mL)	Weight Undissolved, $M(\text{g})$	$M_0^{1/3} - M^{1/3}$	$\kappa$ ( $\text{g}^{1/3}/\text{min}$ )
0	0	0.0750( $M_0$ )	0	—
10	0.01970	0.0553	0.0406	0.0041
20	0.0374	0.0376	0.0866	0.0043
30	0.0510	0.0240	0.1332	0.0044
40	0.0595	0.0155	0.1724	0.0043
50	0.0650	0.0100	0.2063	0.0041

$$\kappa_{av} = \frac{\sum \kappa}{5} = \frac{0.0212}{5} = 0.00424 \text{ g}^{1/3}/\text{min}$$

\*Based on M. J. Miralles, M. S. Thesis, University of Texas, Austin, 1980.

# Hixson-Crowell cube root model

Drug releases by dissolution

Changes in surface area

Changes diameter of the particles

release is not by diffusion

# HIGUCHI'S EQUATION / MODEL

- Fifty years ago, Professor Takeru Higuchi published the derivation of an equation that
- allowed for the quantification of drug release from thin ointment films, containing finely dispersed drug into a perfect sink. Then the equation was later applied to solid drugs dispersed in homogenous and granular matrix

## Applications

- For Drugs are dispersed homogeneously throughout the matrix
- Drug dispersed and released from ointment base.

# Conditions assumed by Higuchi

- (1) Drug transport through the ointment base is rate limiting, whereas drug transport within the skin is rapid.
- (2) The skin acts like a “perfect sink”: The drug concentration in this compartment can be considered to be negligible.
- (3) The initial drug concentration in the film is much higher than the solubility of the drug in the ointment base.
- (4) The drug is finely dispersed within the ointment base (the size of the drug particles is much smaller than the thickness of the film).
- (5) The drug is initially homogeneously distributed throughout the film.
- (6) The dissolution of drug particles within the ointment base is rapid compared to the diffusion of dissolved drug molecules within the ointment base.
- (7) The medium (ointment base) does not swell or dissolve during drug release.

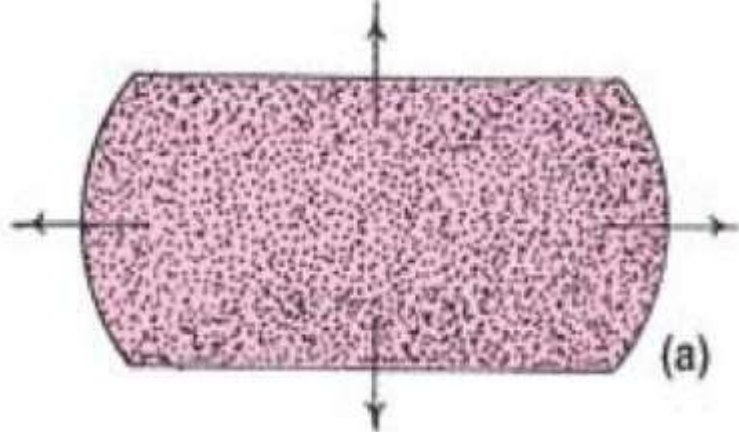

Drug eluted from homogeneous polymer matrix

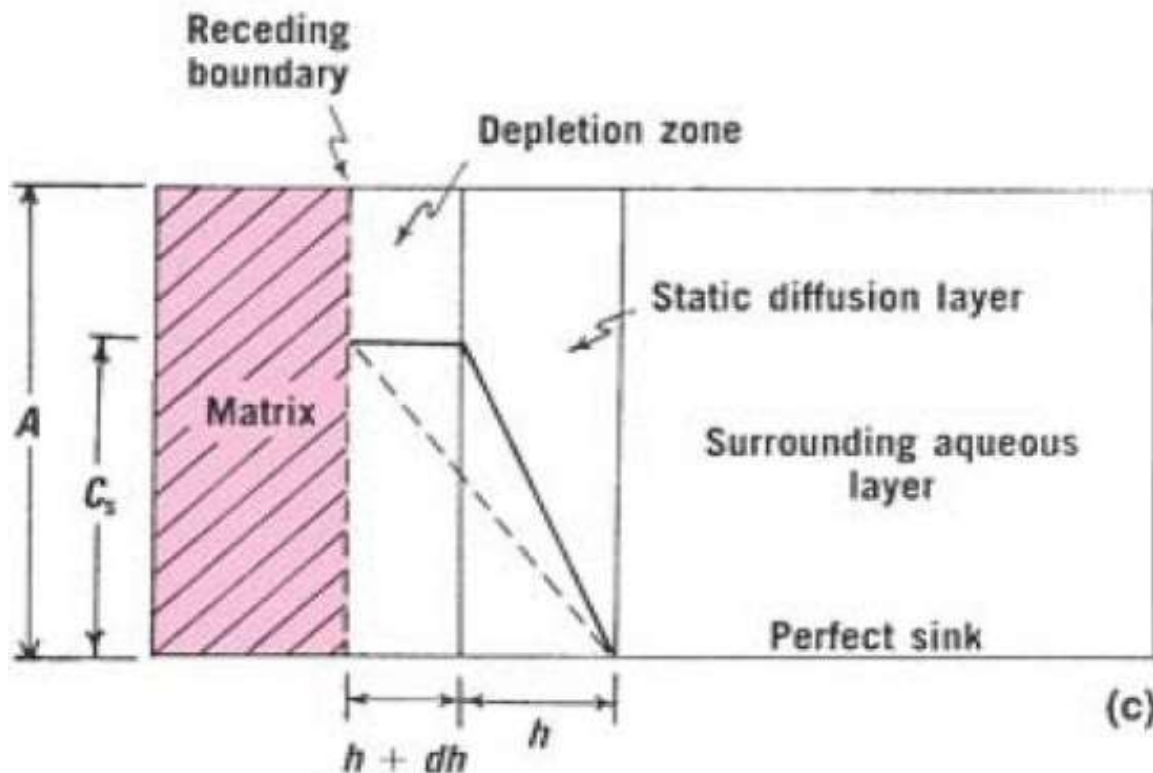
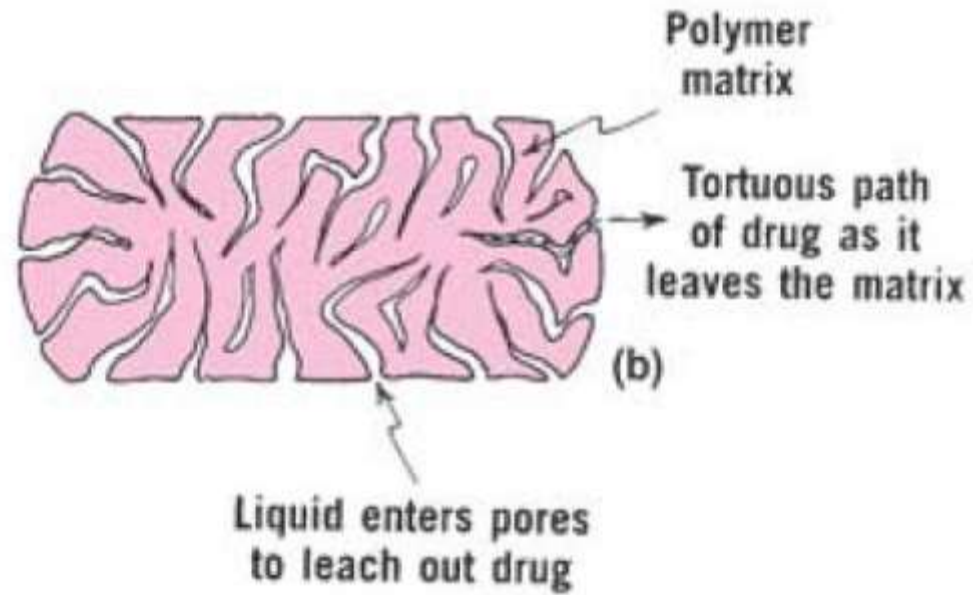

- The drug is assumed to dissolve in the polymer matrix and to diffuse out from the surface of the of the device
- As the drug released, the distance for diffusion becomes increasingly greater
- The boundary that forms between the drug and empty matrix therefore recedes into the tablet as drug is eluted

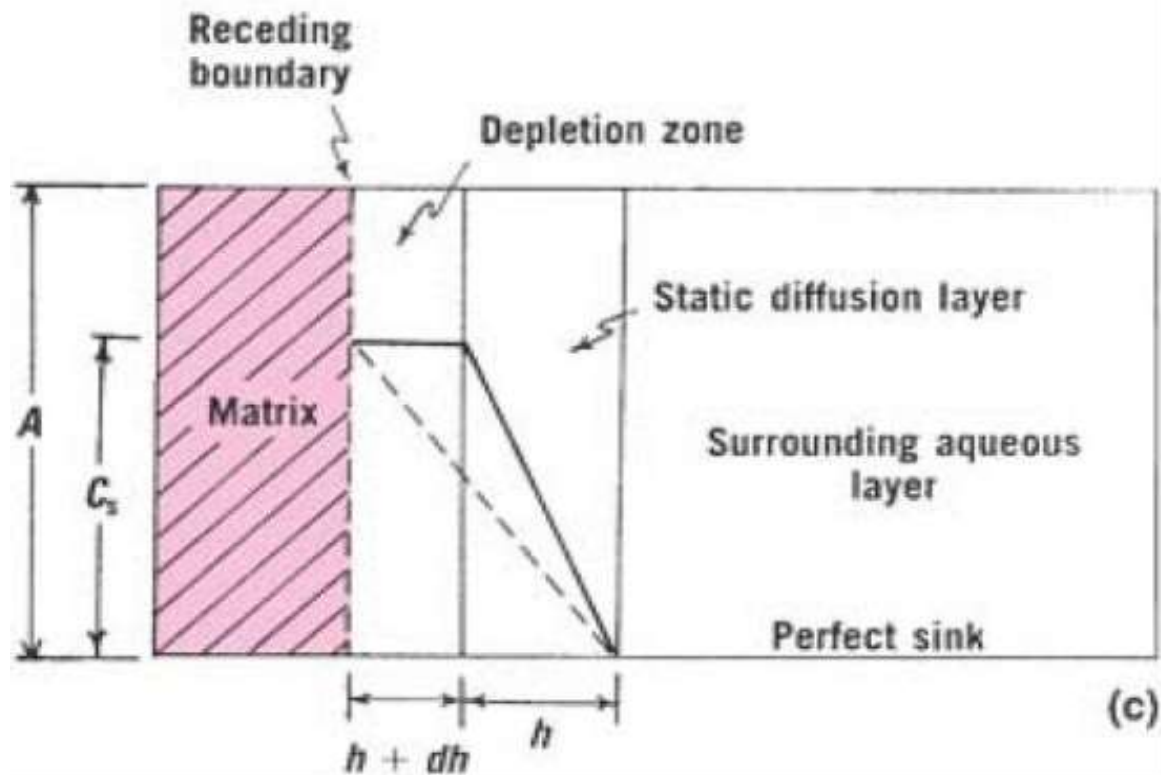



# Higuchi Model

Recall Fick's law

$$\frac{dM}{dt} = \frac{dQ}{dt} = \frac{DC_s}{h}$$

- $dQ/dt$  amount of drug released
- $C_s$ : drug solubility in matrix
- Diffusion layer thickness
- But ??
- As amount diffused of drug from the matrix the distance of diffusion increases from the device by  $dh$  (depletion zone)
- Higuchi found that the amount of drug released could be expressed by follows

# Higuchi

The infinitesimal amount,  $dQ$ , of drug released because of this shift ( $dh$ ) of the front is given by the approximate linear expression

$$dQ = A dh - \frac{1}{2} C_s dh \quad (13-25)$$

$A$ : is the total concentration (amount per unit volume), dissolved and undissolved, of drug in the matrix.

$C_s$ : solubility of drug in matrix

$dh$ : depletion zone thickness

$X$ : distance from skin or receptor

- Because the boundary between the drug matrix and the drug-depleted matrix recedes with time, the thickness of the empty matrix,  $dh$ , through which the drug diffuses also increases with time

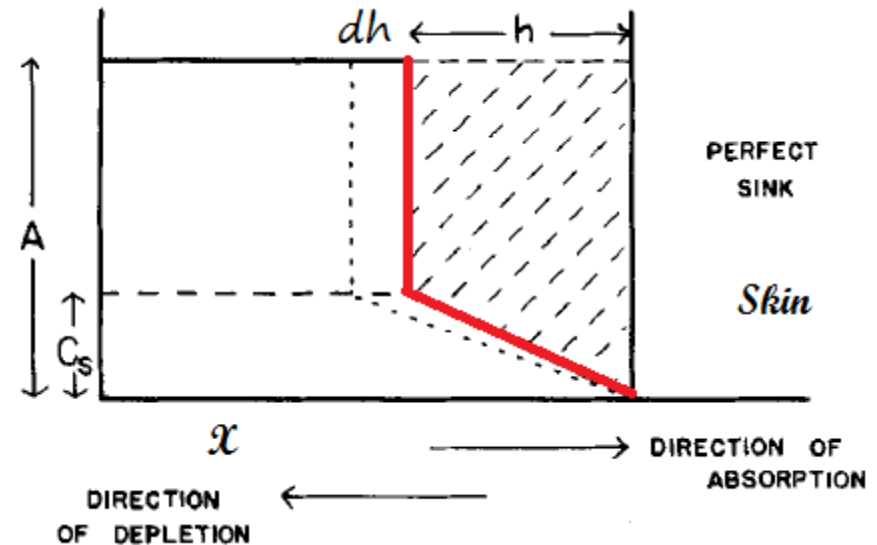

$$\frac{dM}{dt} = \frac{dQ}{dt} = \frac{DC_s}{h}$$

$$dQ = A dh - \frac{1}{2}C_s dh \quad (13-25)$$

*A*: is the total concentration (amount per unit volume), dissolved and undissolved, of drug in the matrix.

*C<sub>s</sub>*: solubility of drug in matrix

*dh*: depletion zone thickness

integration

$$\left(A - \frac{1}{2}C_s\right) dh = \frac{DC_s}{h} dt \quad (13-26)$$

$$\frac{2A - C_s}{2DC_s} \int h dh = \int dt \quad (13-27)$$

$$t = \frac{(2A - C_s)h^2}{4DC_s} \quad (13-28)$$

$$t = \frac{(2A - C_s)h^2}{4DC_s}$$

$$h = \left( \frac{4DC_s t}{2A - C_s} \right)^{1/2} \quad (13-30)$$

The amount of drug depleted per unit area of matrix,  $Q$ , at time  $t$  is obtained by integrating equation (13-25) to yield

$$Q = hA - \frac{1}{2}hC_s \quad (13-31)$$

Substituting equation (13-30) into (13-31) produces the result

$$Q = \left( \frac{DC_s t}{2A - C_s} \right)^{1/2} (2A - C_s) \quad (13-32)$$

**Higuchi's  
Equation**

which is known as the Higuchi equation:

$$Q = [D(2A - C_s)C_s t]^{1/2}$$

The instantaneous rate of release of a drug at time  $t$  is obtained by differentiating equation (13-33) to yield

$$\frac{dQ}{dt} = \frac{1}{2} \left[ \frac{D(2A - C_s)C_s}{t} \right]^{1/2} \quad (13-34)$$

$$Q = [D(2A - C_s)C_s t]^{1/2}$$

$$\frac{dQ}{dt} = \frac{1}{2} \left[ \frac{D(2A - C_s)C_s}{t} \right]^{1/2}$$

- Ordinarily,  $A$  is much greater than  $C_s$  (solubility in matrix), and equation (Higuchi assumption)

Ordinarily,  $A$  is much greater than  $C_s$ , and equation (13-33) reduces to

$$Q = (2ADC_s t)^{1/2} \quad (13-35)$$

and equation (13-34) becomes

$$\frac{dQ}{dt} = \left( \frac{ADC_s}{2t} \right)^{1/2} \quad (13-36)$$

The equation for Higuchi's  
For drug release through matrix

$$Q = K_H t^{1/2}$$

Q = cumulative amount of drug  
release at time "t"

$K_H$  = Higuchi constant

t = time in hours

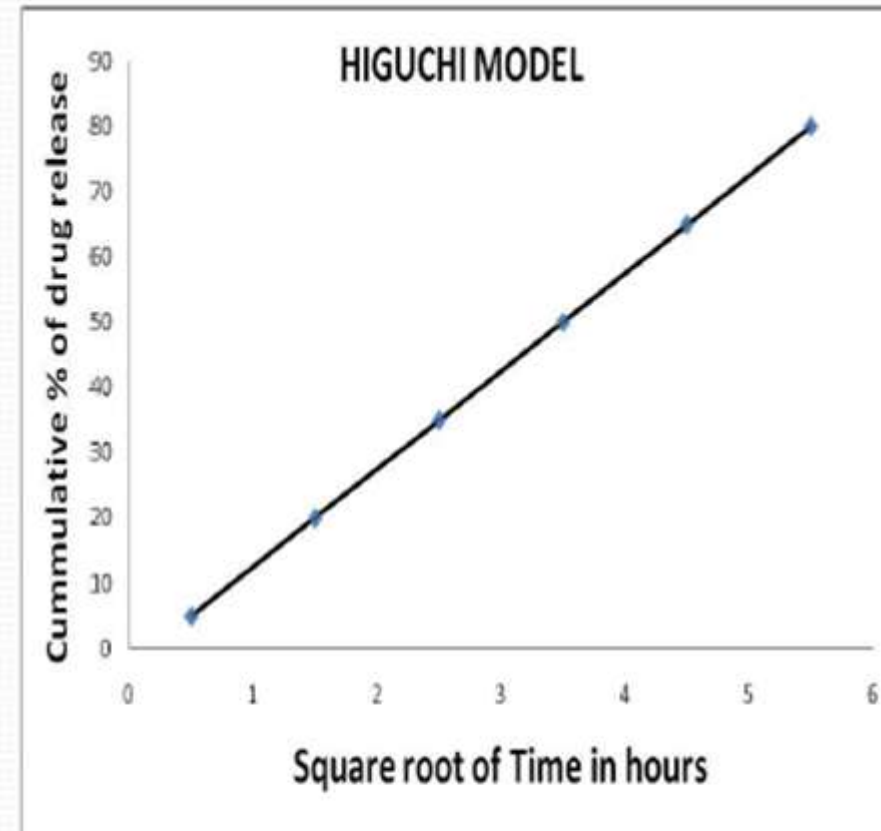

Graphical  
representation

- Amount of drug released Vs square root of time.

The dissolution in 500 ml water data are found in the table below.

T(hr)	Concent. Drug release mg/ml	Amount drug release Mg (in 500ml) $Q_t$	$T^{(1/2)}$	K $mg^{*}(1/2)/hr$
0	0	0	0.000	
2	0.42	210	1.414	148.4924
4	0.59	295	2.000	147.5
6	0.74	370	2.449	151.0519
8	0.876	438	2.828	154.8564
10	0.98	490	3.162	154.9516

$$Q = kt^{\frac{1}{2}}$$

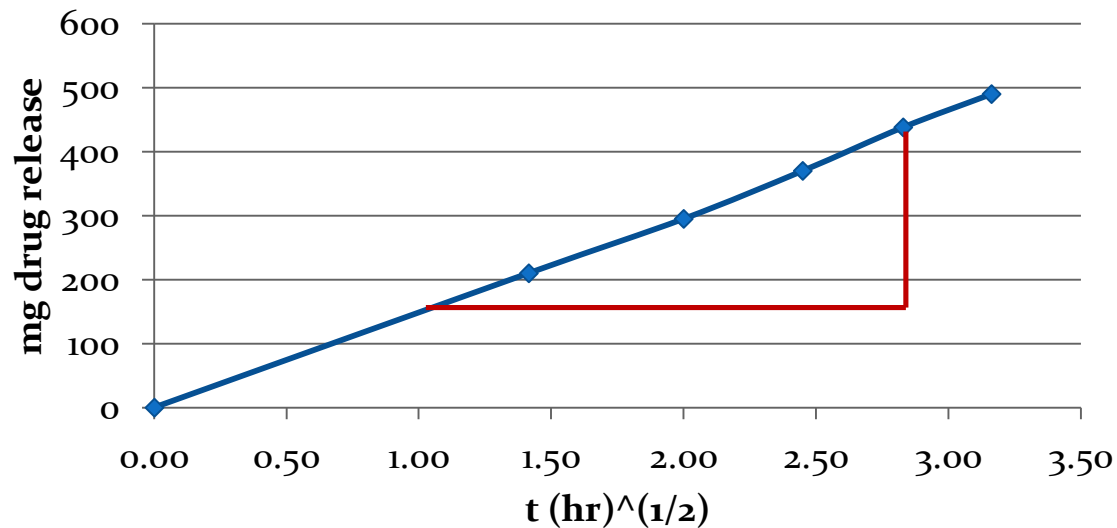

<i>Kinetic Model</i>	<i>Systems that Follow the Model</i>
First order	Water-soluble drugs in porous matrix
Zero order	Osmotic systems, transdermal systems
Higuchi's square root of time equation	Diffusion matrix formulations
Weibull	Erodible matrix formulations
Hixson-Crowell's cube-root equation	Erodible matrix formulations
Korsmeyer-Peppas' power law equation	Swellable polymeric devices
Peppas-Sahlin	Swellable polymeric devices
Baker-Lonsdale	Microcapsules or microspheres