

Renal System

(a) The urinary system

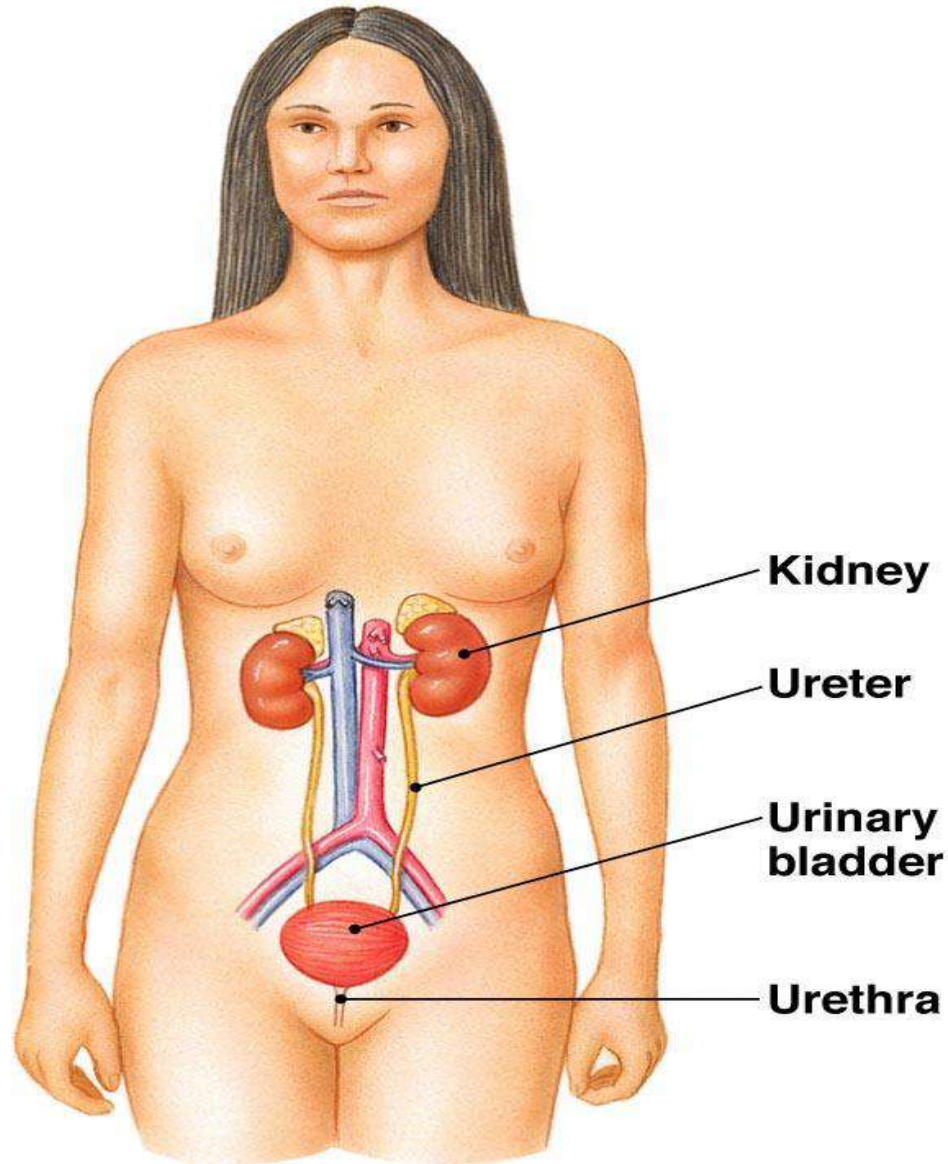

Kidney Functions

- Everyday the kidneys *filter* nearly **200 liters** of fluid from blood stream to maintain internal environment by:
- **Regulating total volume of body *water*** and total concentration of *solutes* (osmolality).
- **Regulating the concentration** of different *ions in ECF*.
- Maintaining long-term ***acid-base balance***
- ***Excreting* metabolic wastes** and foreign substances

Other Renal Functions

- Producing *erythropoietin* – stimulate RBC production
- *Gluconeogenesis* during prolonged fasting
- Production of *renin* - regulate blood pressure
- Activation of *vitamin D*

Kidney Location and External Anatomy

- The kidneys lie in a *retroperitoneal position* in the superior lumbar region
- The right kidney is **lower** than the left because it is crowded by the liver
- The lateral surface of the kidney is **convex**; the medial surface is concave
- The **renal hilum** leads to the renal sinus
- **Ureters, renal blood vessels, lymphatics, and nerves enter and exit at the hilum**

Urinary System Organs

The kidneys are located retroperitoneally at the level of the lower ribs.

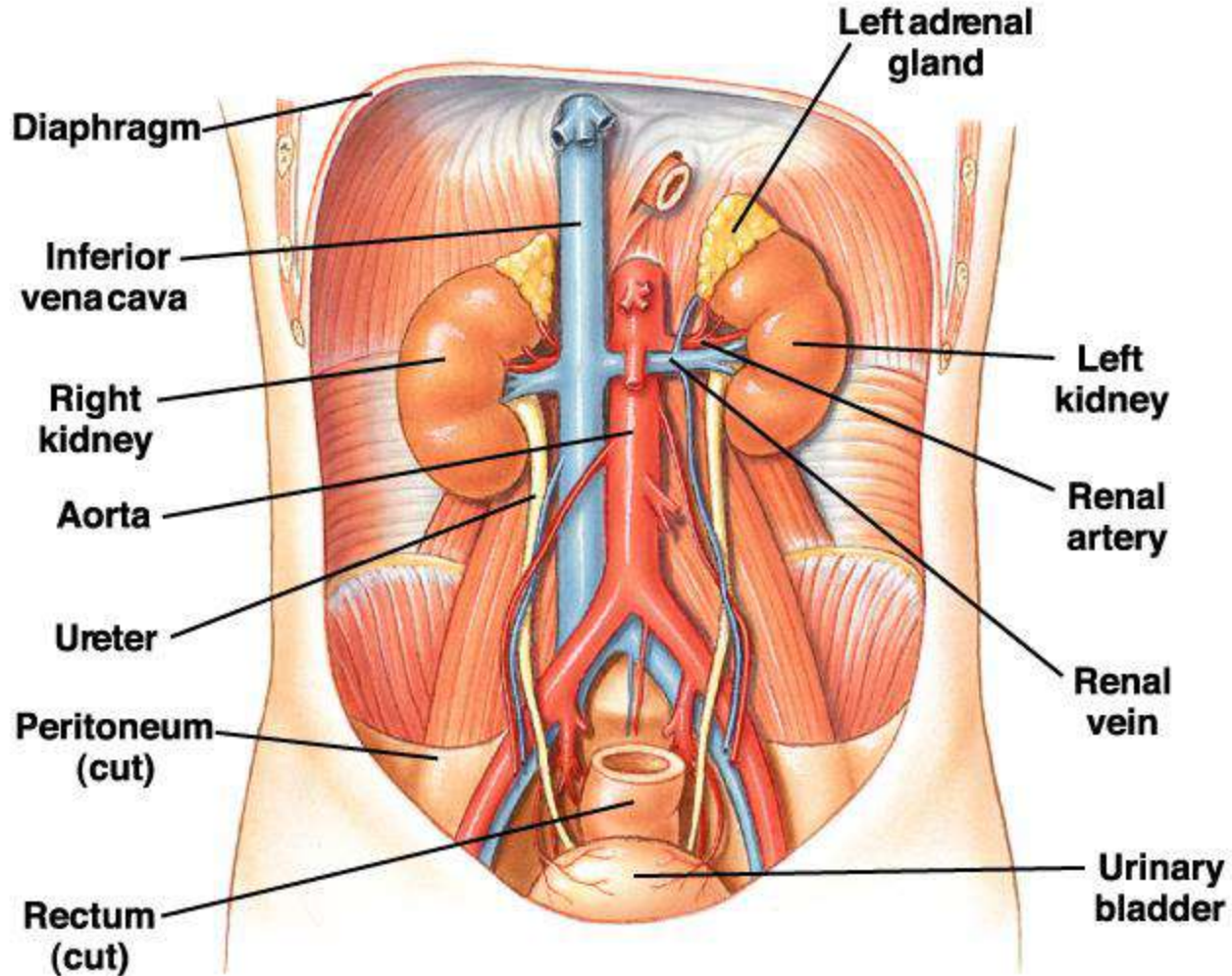

Other Urinary System Organs

- **Urinary bladder** – provides a temporary storage reservoir for urine
- **Paired ureters** – transport urine from the kidneys to the bladder
- **Urethra** – transports urine from the bladder out of the body

Layers of Tissue Supporting the Kidney

- **Renal capsule** – fibrous capsule that prevents kidney infection
- **Adipose capsule** – fatty mass that cushions the kidney and protect them against blows.
- **Renal fascia** – outer layer of dense fibrous connective tissue that anchors the kidney and helps attach it to the body wall

Kidney Location and External Anatomy

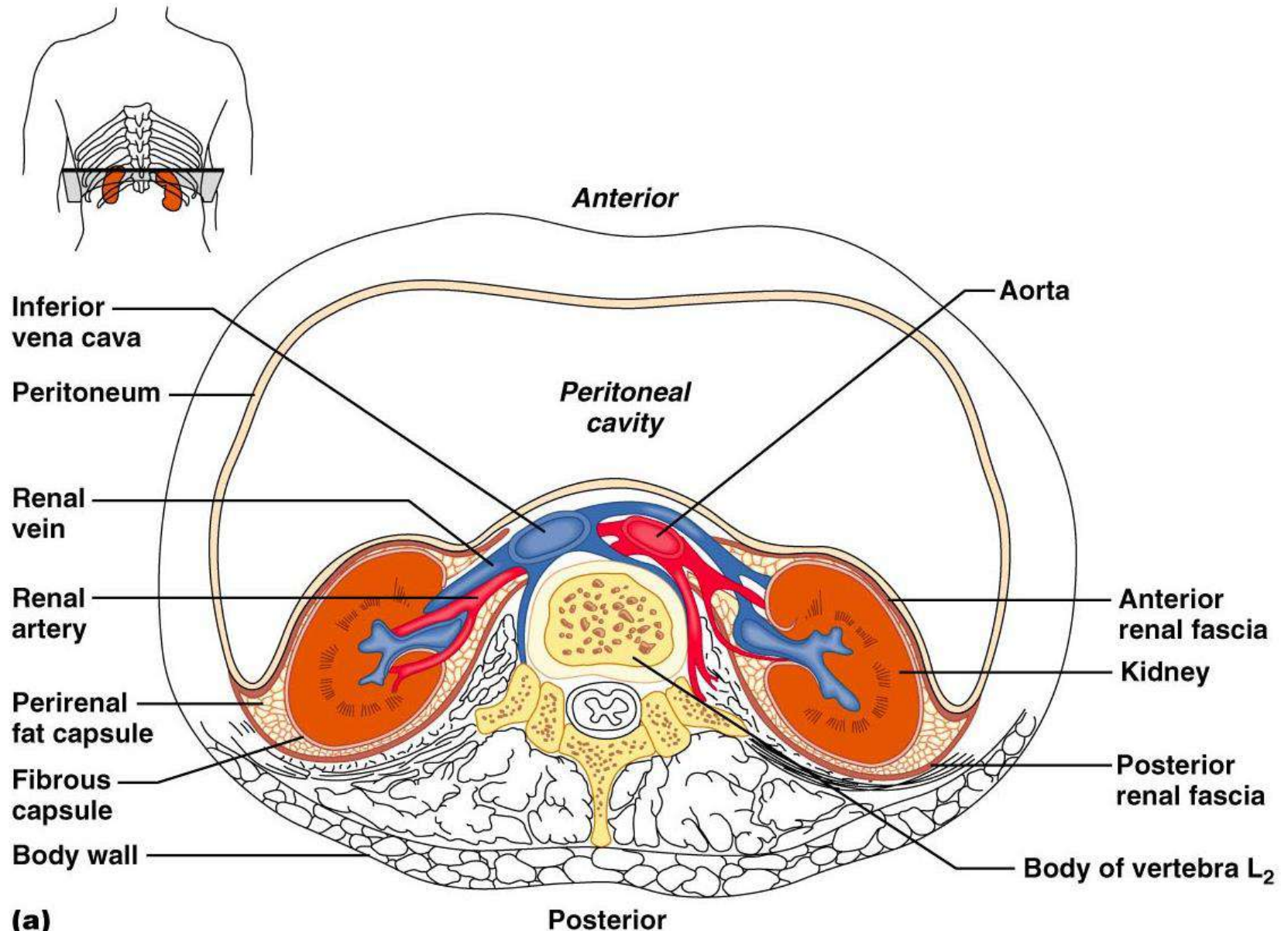

Internal Anatomy (Frontal Section)

- **Cortex** – the light colored, granular superficial region
- **Medulla** – exhibits cone-shaped medullary (renal) pyramids separated by columns
 - The medullary pyramid and its surrounding capsule constitute a lobe
- **Renal pelvis** – flat funnel shaped tube lateral to the hilum within the renal sinus

Internal Anatomy (Continue)

- **Major calyces** – large branches of the renal pelvis
 - Collect urine draining from papillae
 - Empty urine into the pelvis
- Urine flows through the pelvis and ureters to the bladder

Internal Anatomy

(c) In cross section, the kidney is divided into an outer cortex and an inner medulla. Urine leaving the nephrons flows into the renal pelvis prior to passing through the ureter into the bladder.

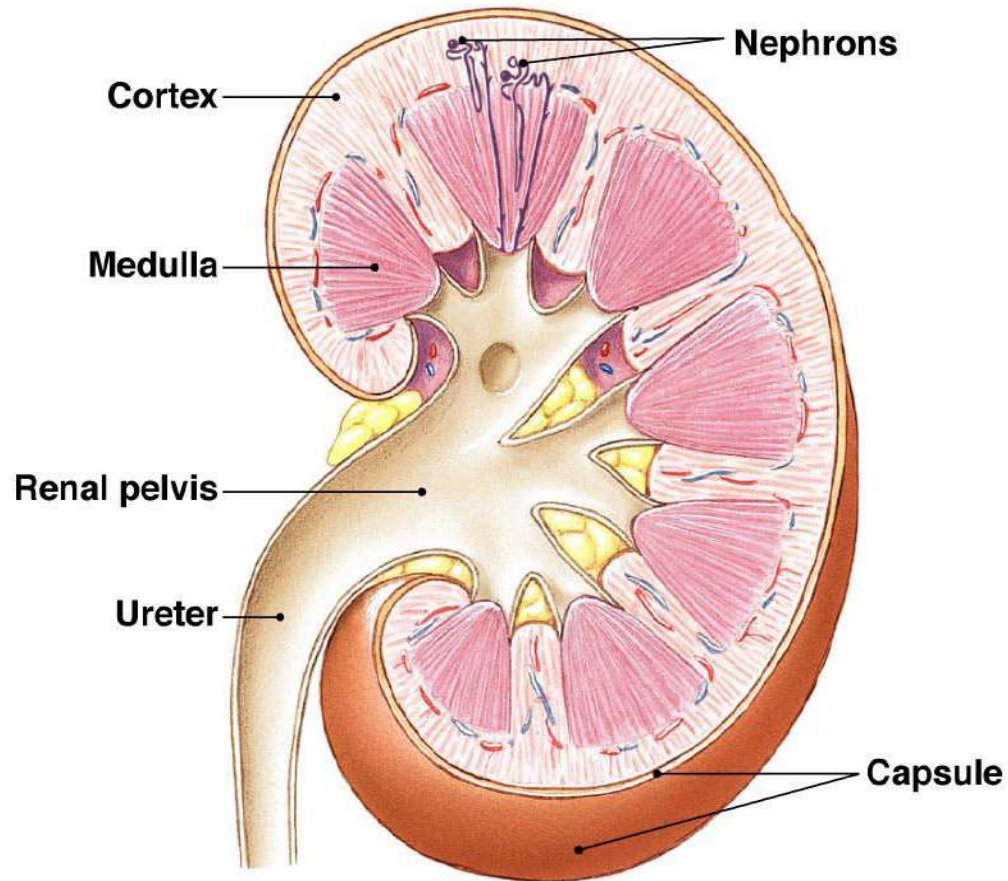

Copyright © 2007 Pearson Education, Inc., publishing as Benjamin Cummings.

Figure 19-1c

Blood and Nerve Supply

- Approximately one-fourth (1200 ml) of systemic cardiac output flows through the kidneys each minute
- Arterial flow into and venous flow out of the kidneys follow similar paths
- *The nerve supply is via the renal plexus*

Internal Anatomy

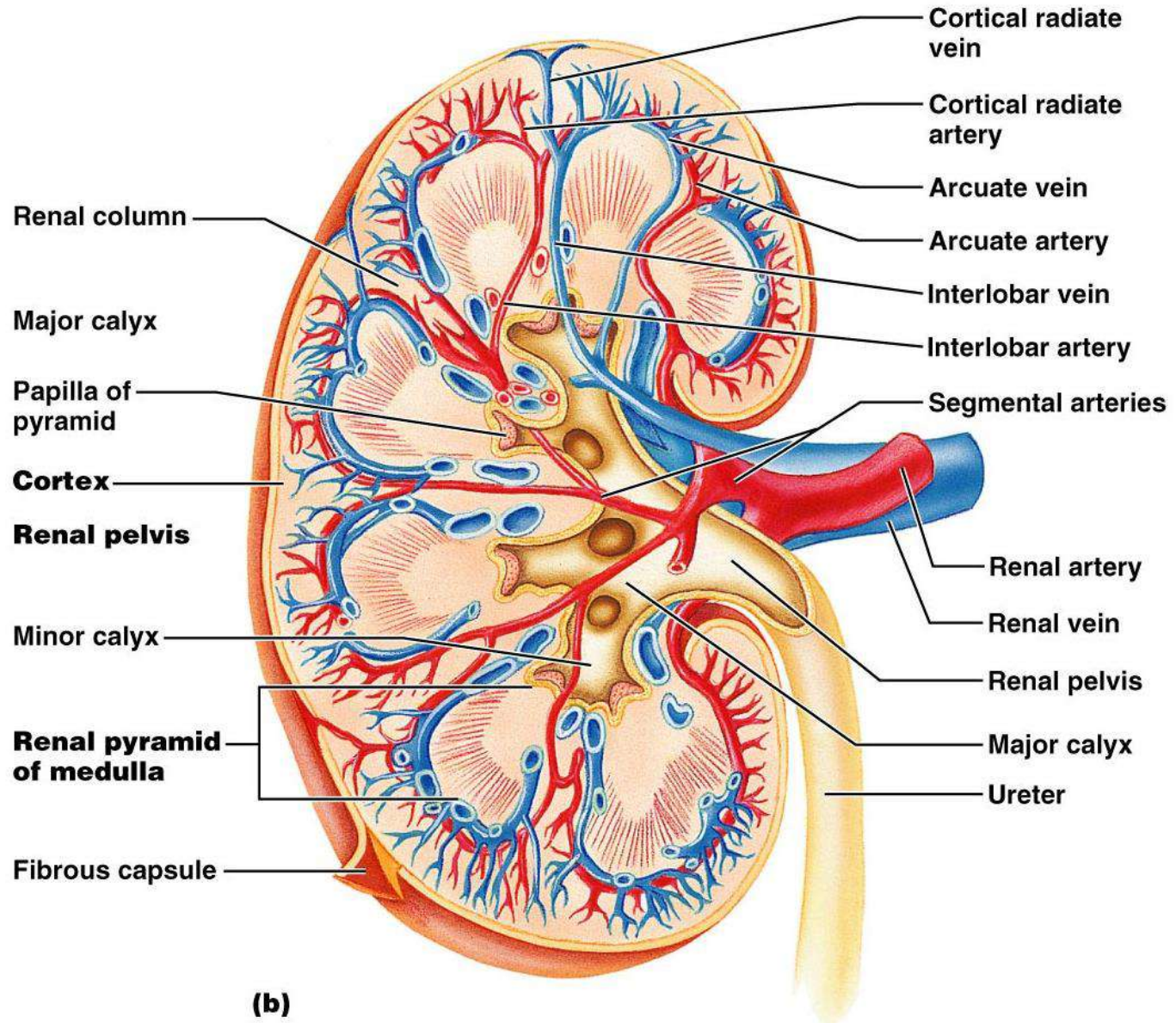

Renal Vascular Pathway

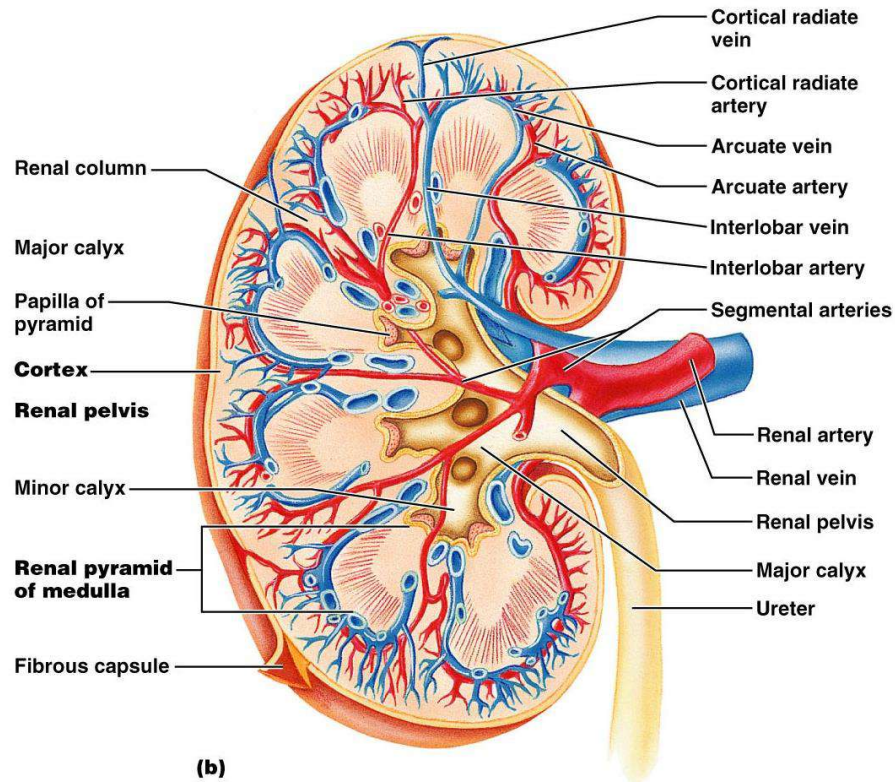
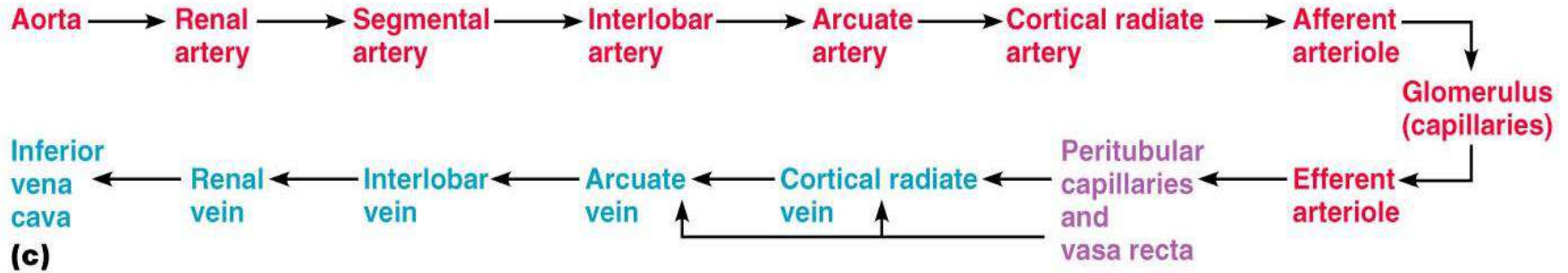

STRUCTURE OF THE KIDNEY

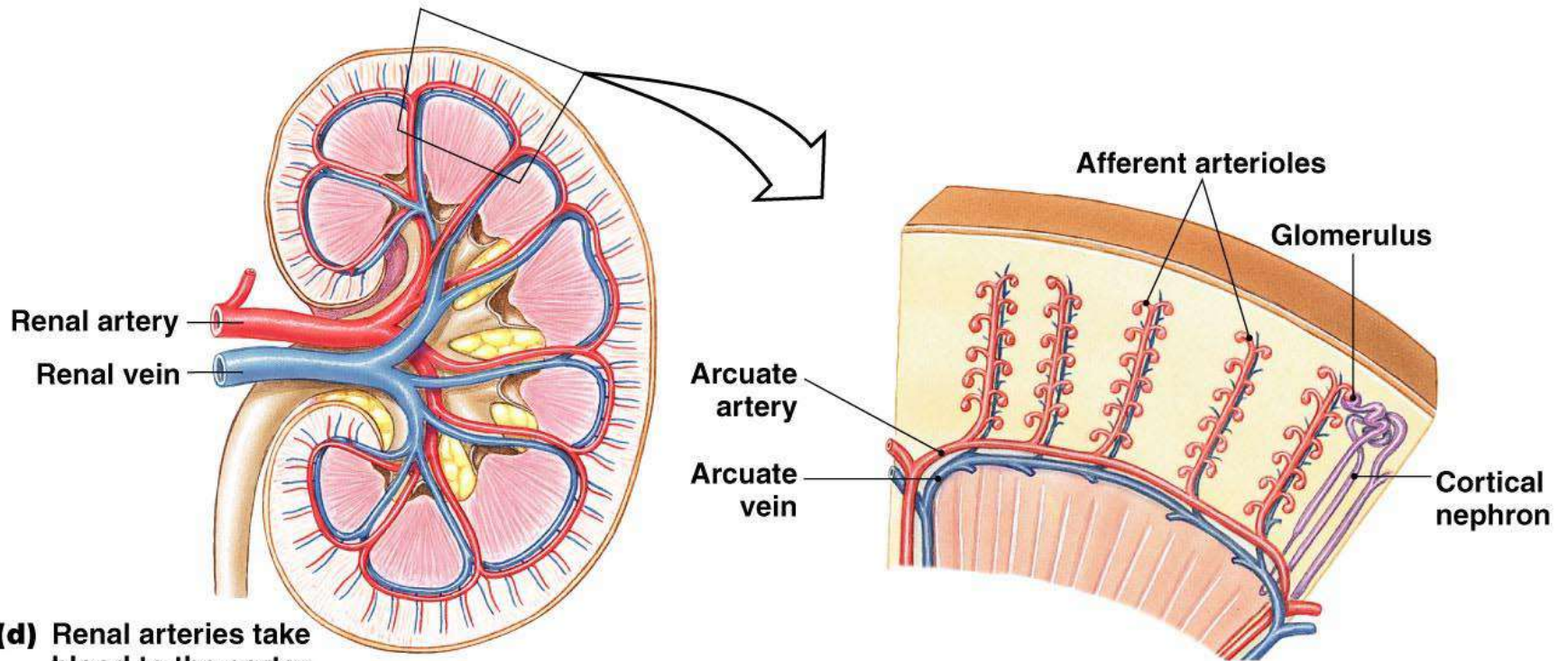

(d) Renal arteries take blood to the cortex.

(e) Afferent arterioles and glomeruli are all found in the cortex.

Copyright © 2007 Pearson Education, Inc., publishing as Benjamin Cummings.

The Nephron

- Each kidney has about 1,000,000 nephron
- Nephrons are the **structural and functional units** that form urine, consisting of:
 - **Renal corpuscle** – a tuft of capillaries called *Glomerulus* and a cup-shaped hollow structure called *Glomerular (Bowman's) capsule*. Located in the renal cortex
 - **Renal tubule** – about 3cm long tubule: *Proximal convoluted tubule (PCT)*; *Nephron loop (loop of Henle)*; *Distal convoluted tubule (DCT)*

(c) In cross section, the kidney is divided into an outer cortex and an inner medulla. Urine leaving the nephrons flows into the renal pelvis prior to passing through the ureter into the bladder.

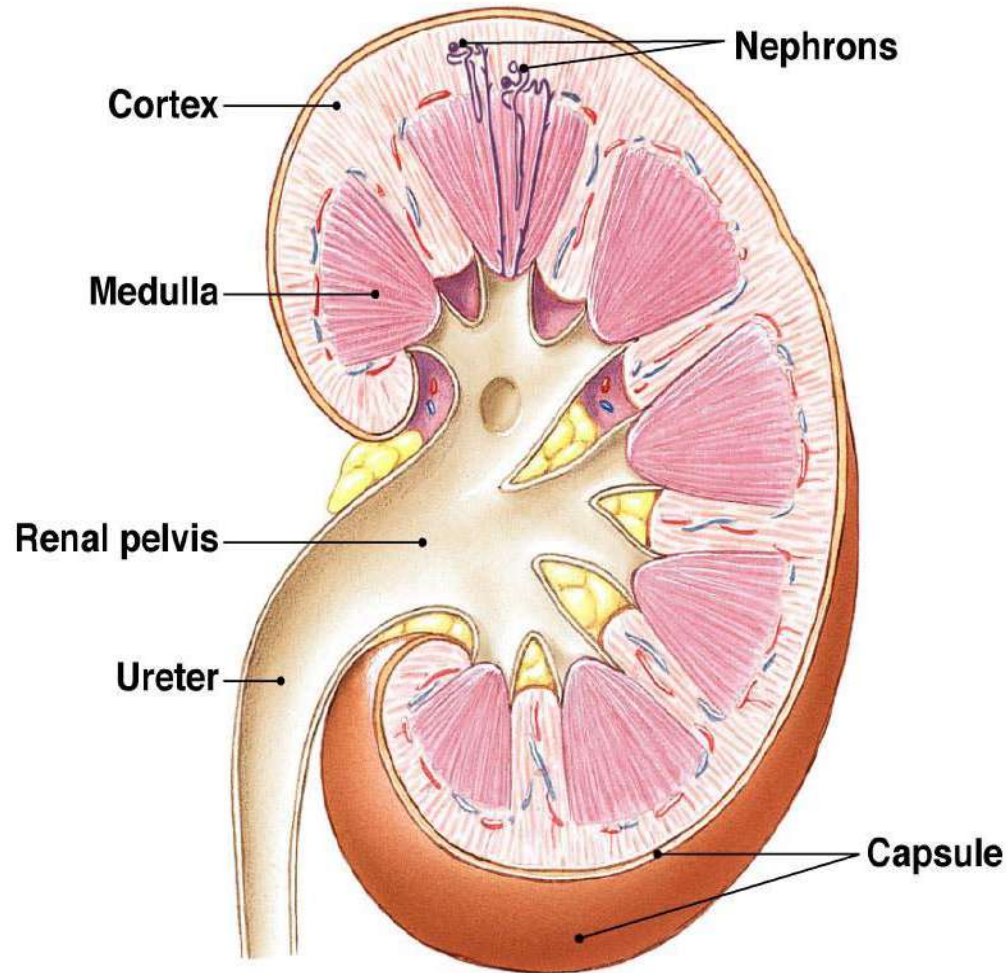

Copyright © 2007 Pearson Education, Inc., publishing as Benjamin Cummings.

Figure 19-1c

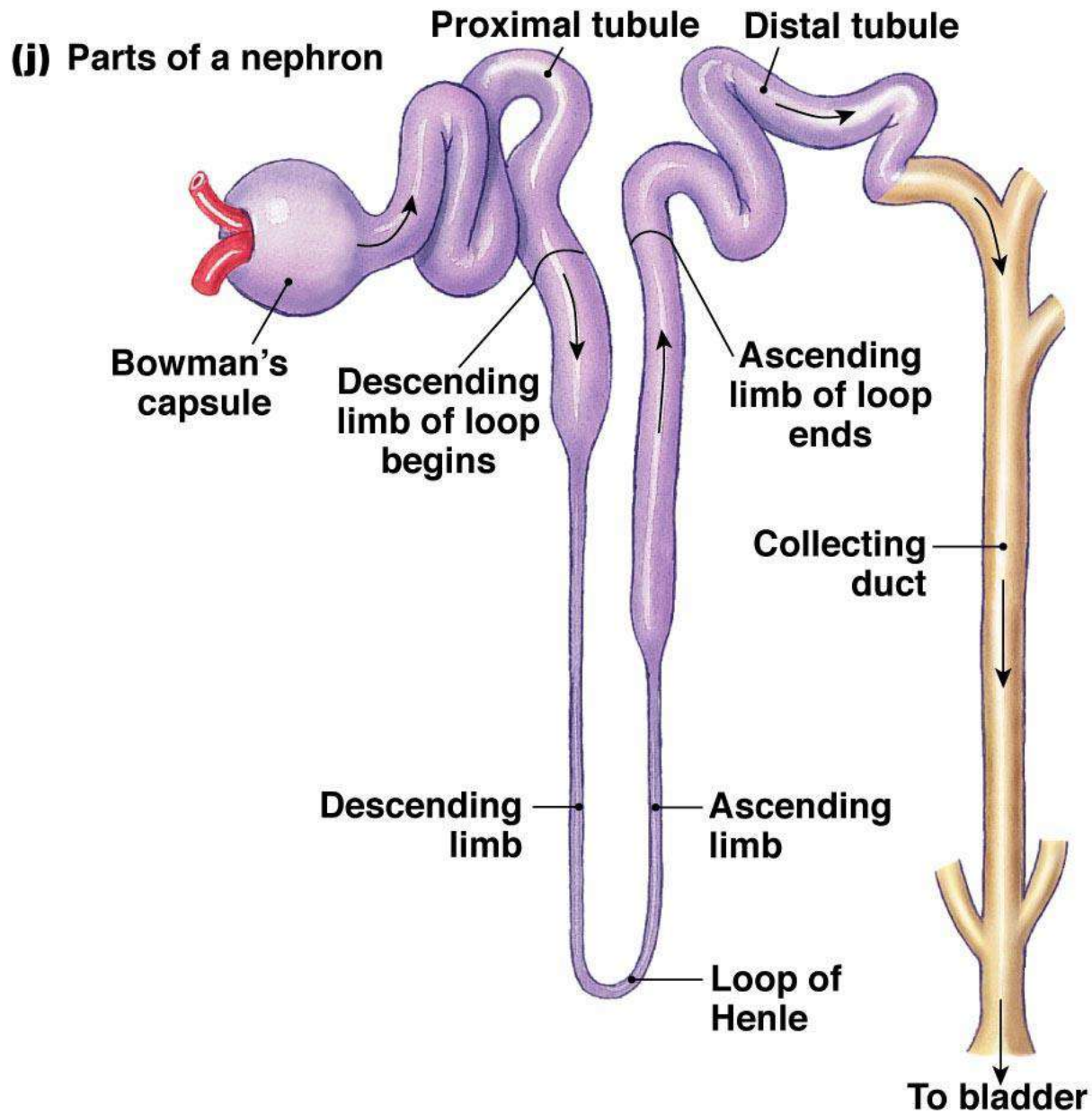

Renal Tubule

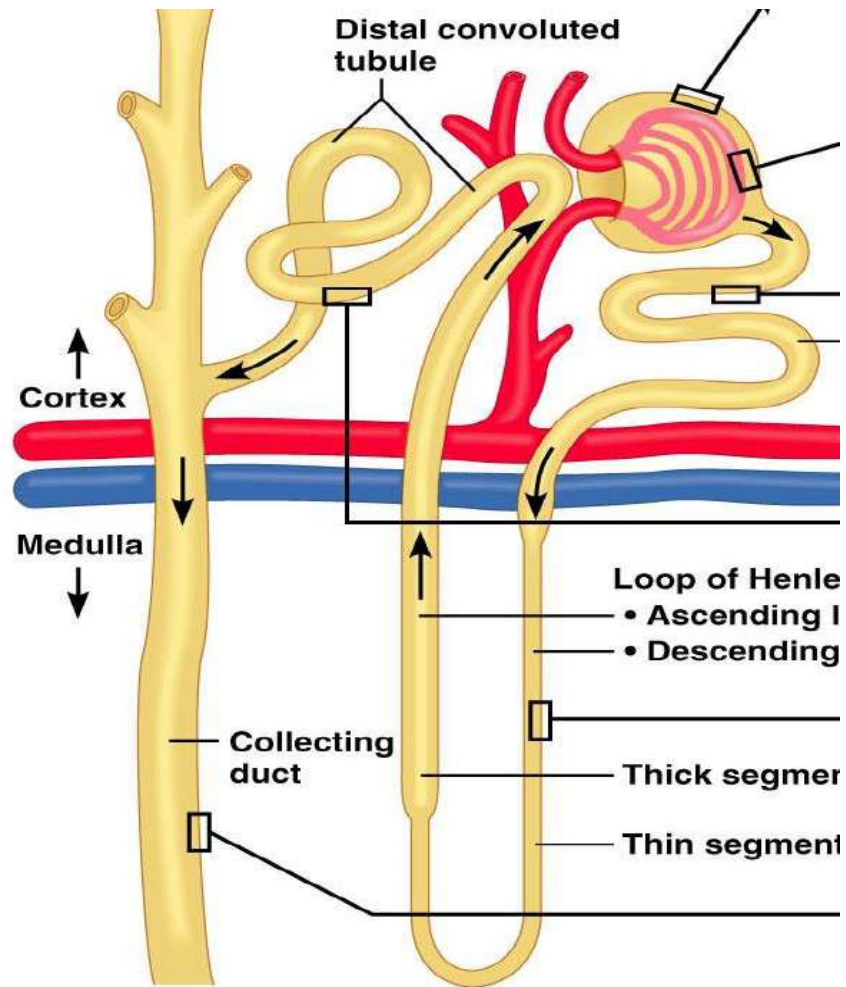

(b)

Copyright © 2006 F

(g) Each nephron has two arterioles and two sets of capillaries associated with it.

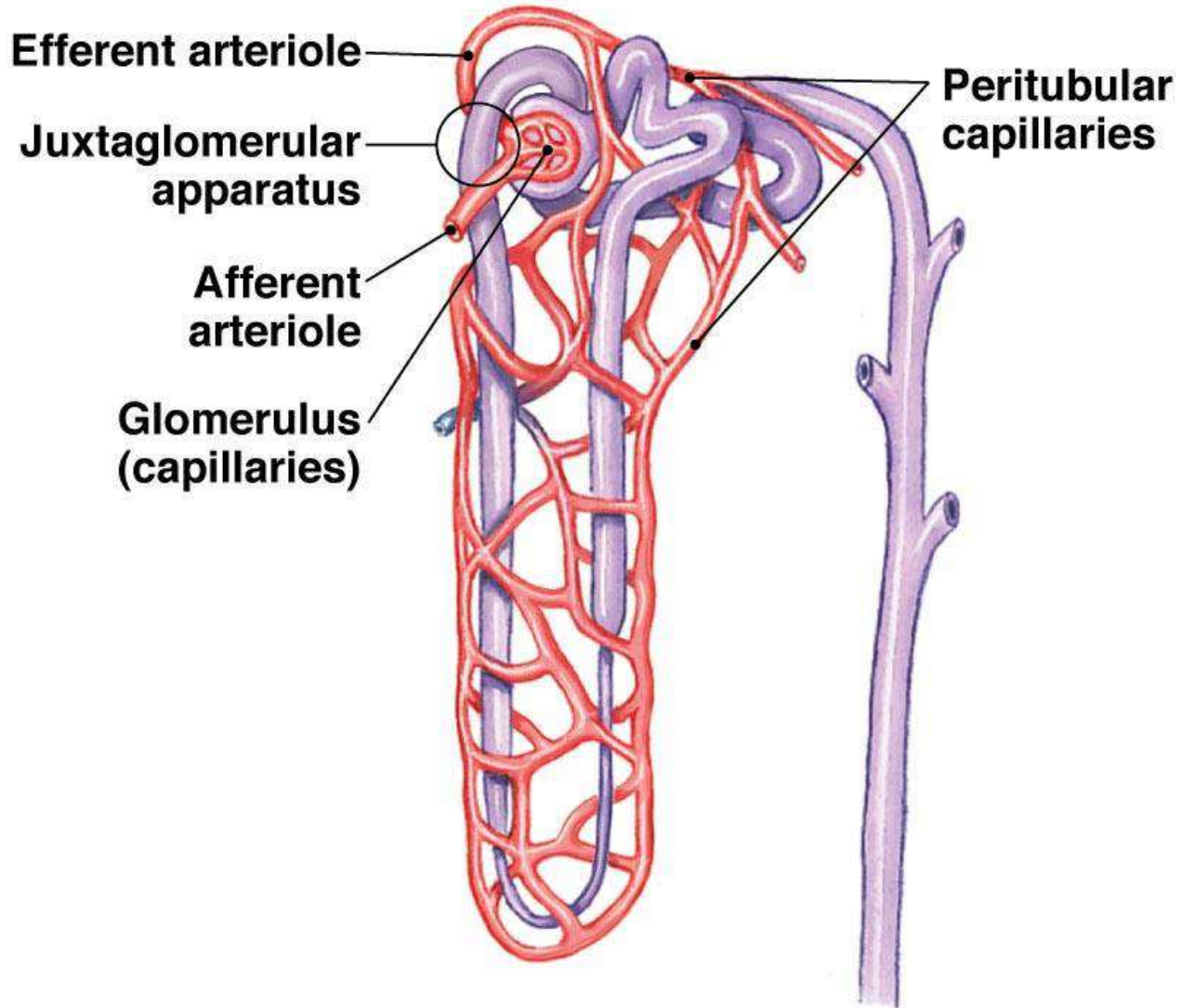

Renal Corpuscle

- **Glomerulus** – a tuft of capillaries specialized for filtration
 - *Glomerular endothelium* – fenestrated epithelium that allows solute-rich, virtually protein-free filtrate to pass from the blood into the glomerular capsule
- **Glomerular (Bowman's) capsule** – blind, cup-shaped end of a renal tubule that completely surrounds the glomerulus

Renal Corpuscle

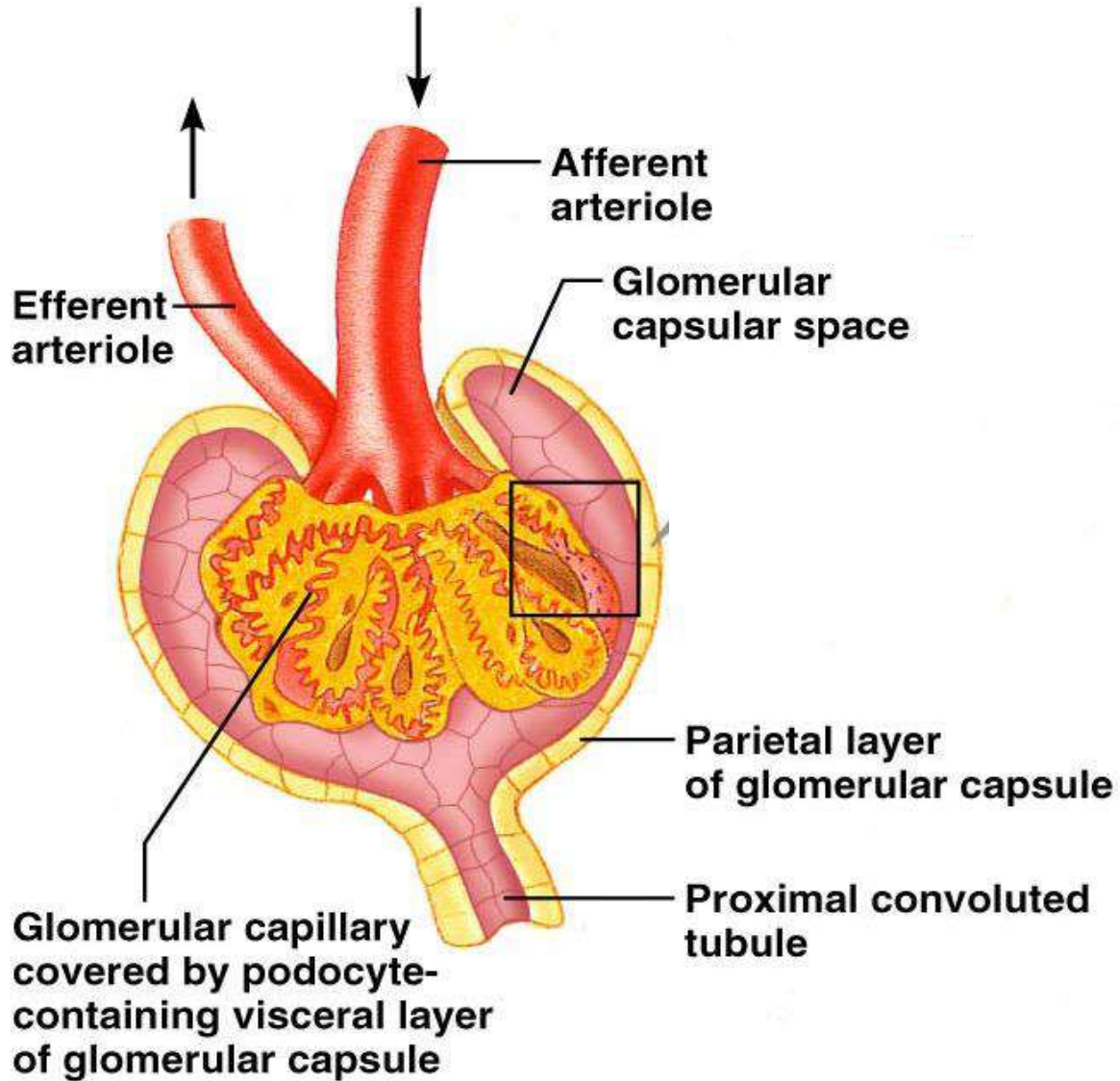

(a) The epithelium around glomerular capillaries is modified into podocytes.

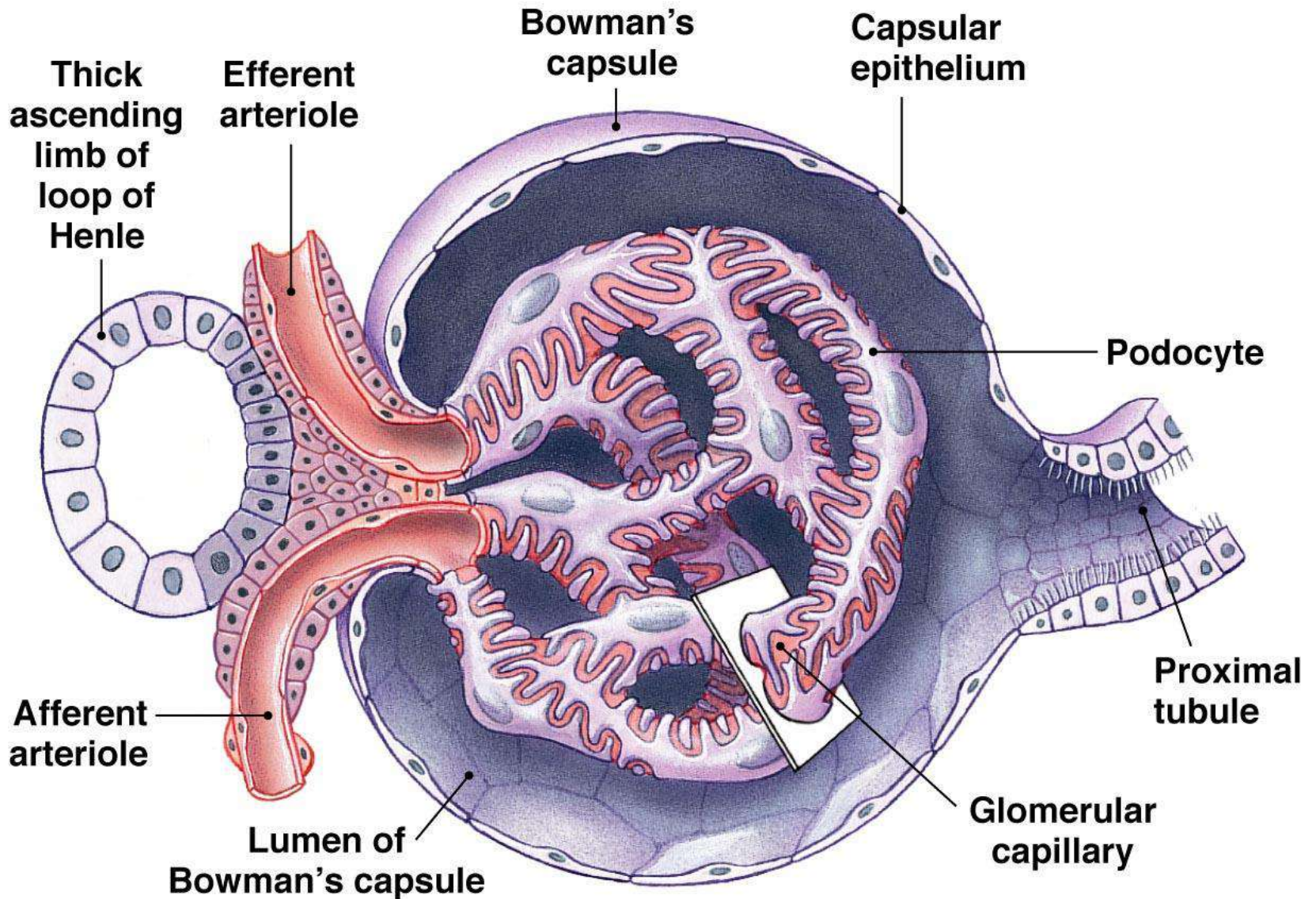

Anatomy of the Glomerular Capsule

- *The external parietal layer* is a structural layer
- *The visceral layer* consists of modified, branching epithelial **podocytes**
- Extensions of the octopus-like podocytes terminate in foot processes
- **Filtration slits** – openings between the foot processes that allow filtrate to pass into the capsular space

Renal Corpuscle

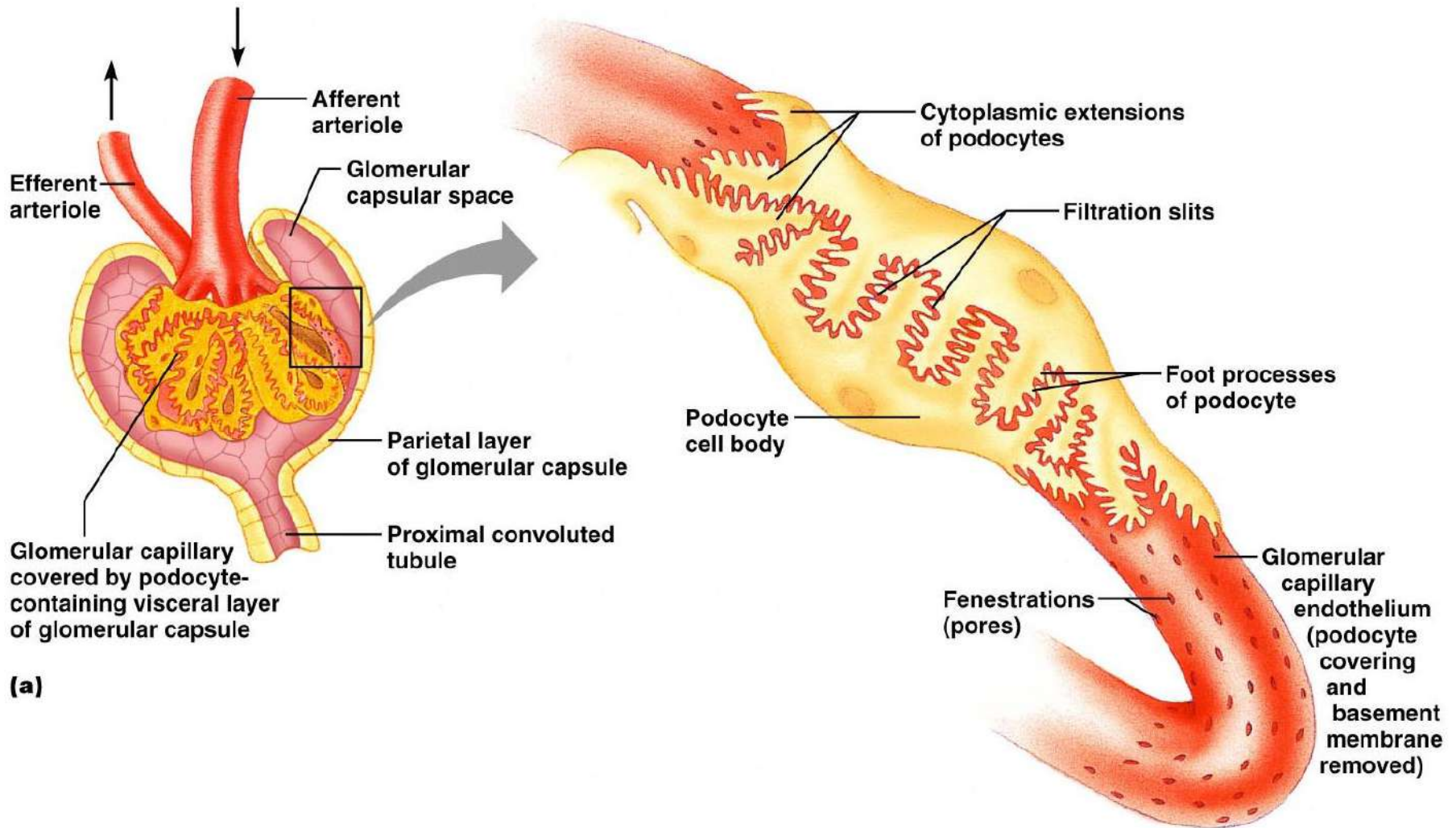

Renal Tubule-1

- **Proximal convoluted tubule (PCT)** – composed of cuboidal cells with numerous microvilli and contain mitochondria
 - Reabsorbs water and solutes from filtrate and secretes substances into it

Renal Tubule-2

- **Nephron Loop (Loop of Henle)** – a hairpin-shaped loop of the renal tubule
 - Proximal part is similar to the proximal convoluted tubule (*cuboidal cells with numerous microvilli and contain mitochondria*)
 - Proximal part is followed by the **thin segment** (simple squamous cells) and the **thick segment** (cuboidal to columnar cells)
- **Distal convoluted tubule (DCT)** – cuboidal cells without microvilli that function **more in secretion than reabsorption**

Renal Tubule

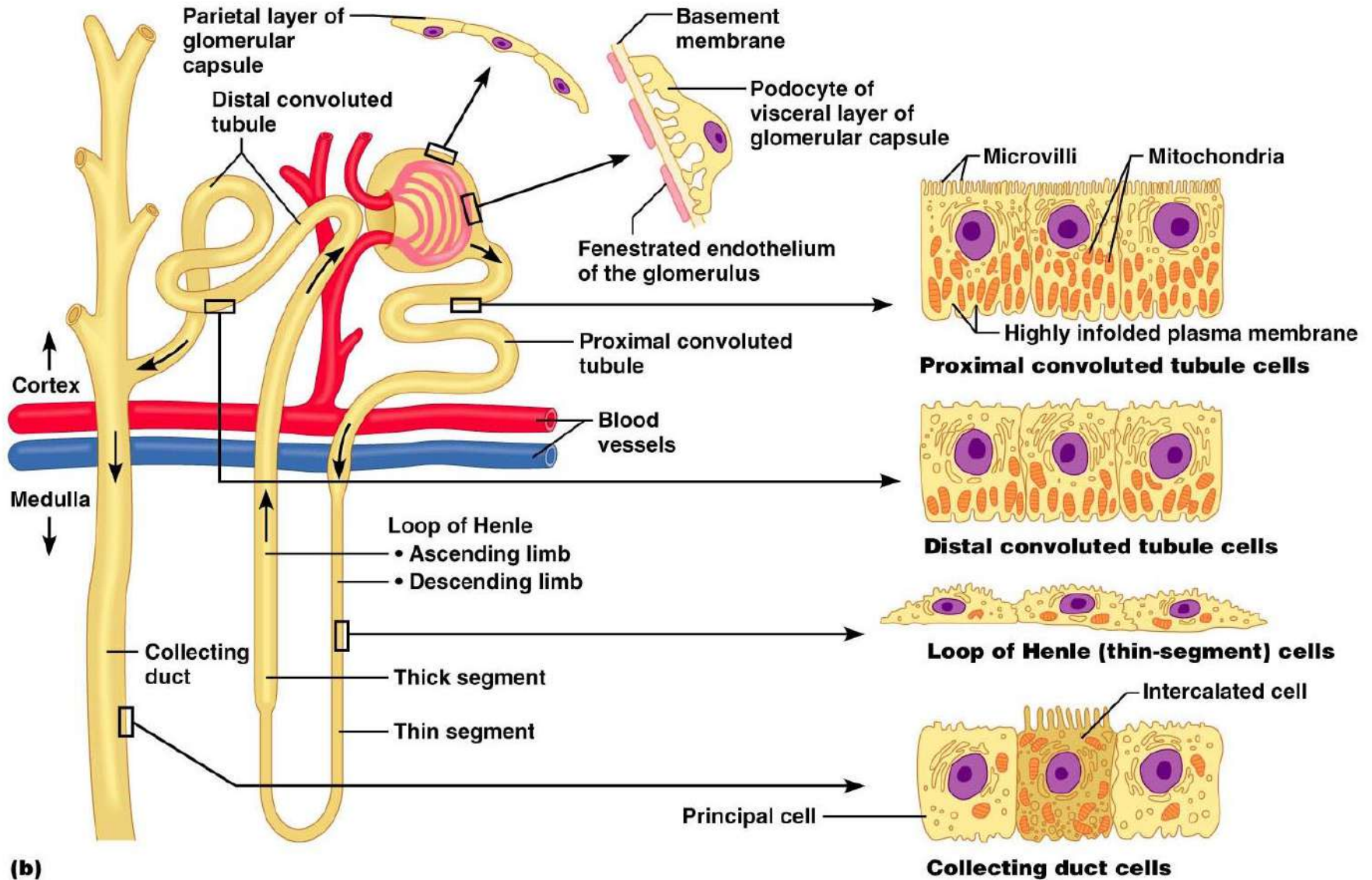

Collecting Tubules

- Two important cell types are found here
 - **Intercalated cells**
 - **Cuboidal cells with microvilli**
 - Function in maintaining the acid-base balance of the body
 - **Principal cells**
 - **Cuboidal cells without microvilli**
 - Help maintain the body's water and salt balance

Nephron Anatomy

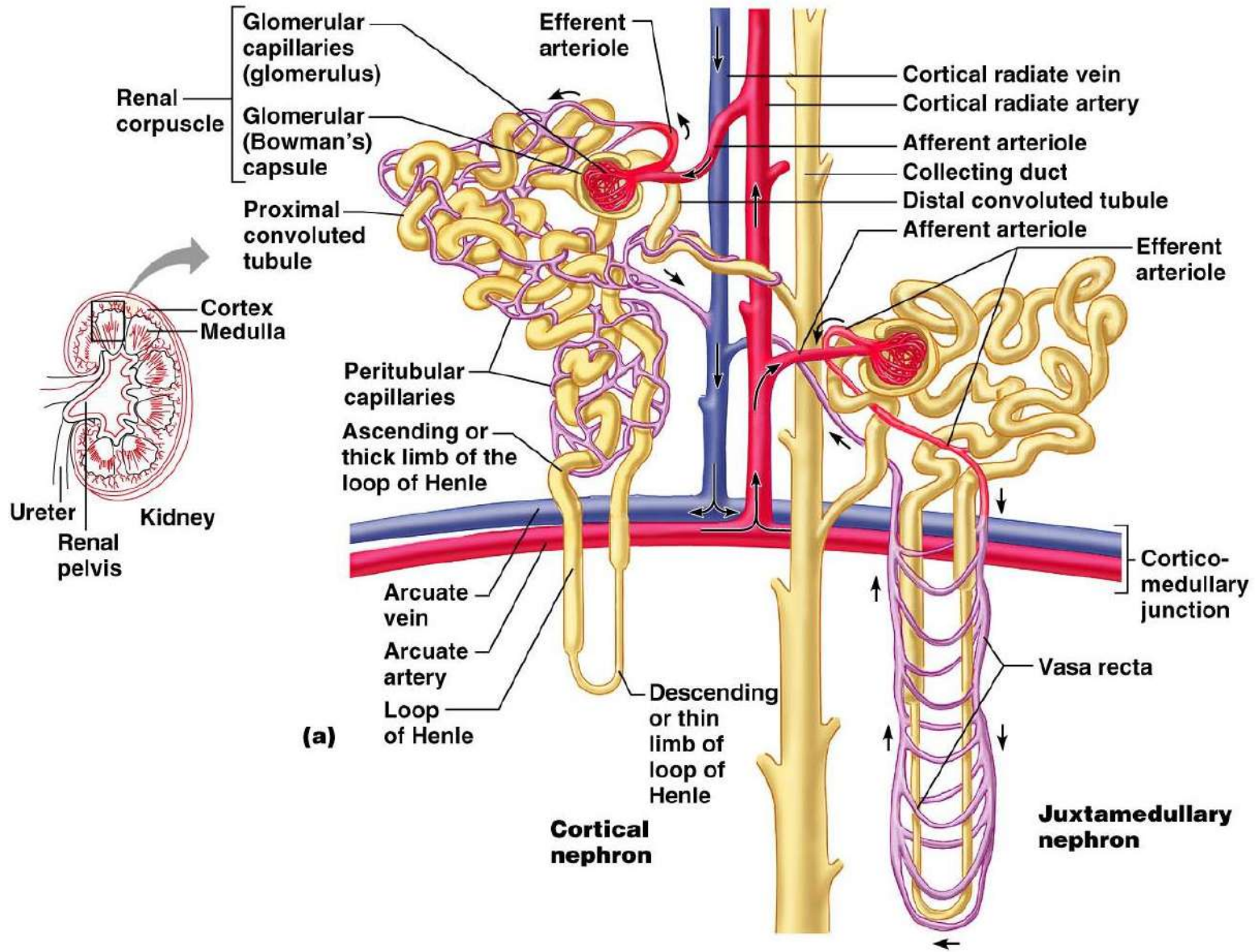

Capillary Beds of the Nephron

- Every nephron has two capillary beds
 - ***Glomerulus***
 - Fed by an afferent arteriole
 - Drained by an efferent arteriole
 - ***Peritubular capillaries***
 - Cling to adjacent renal tubules
 - Fed by the efferent arteriole
 - Drained by the renal venous system

Capillary Beds of the Nephron

- Blood pressure in the glomerulus is high because:
 - Arterioles are high-resistance vessels
 - Afferent arterioles have larger diameters than efferent arterioles
- Fluids and solutes are forced out of the blood throughout the entire length of the glomerulus

(g) Each nephron has two arterioles and two sets of capillaries associated with it.

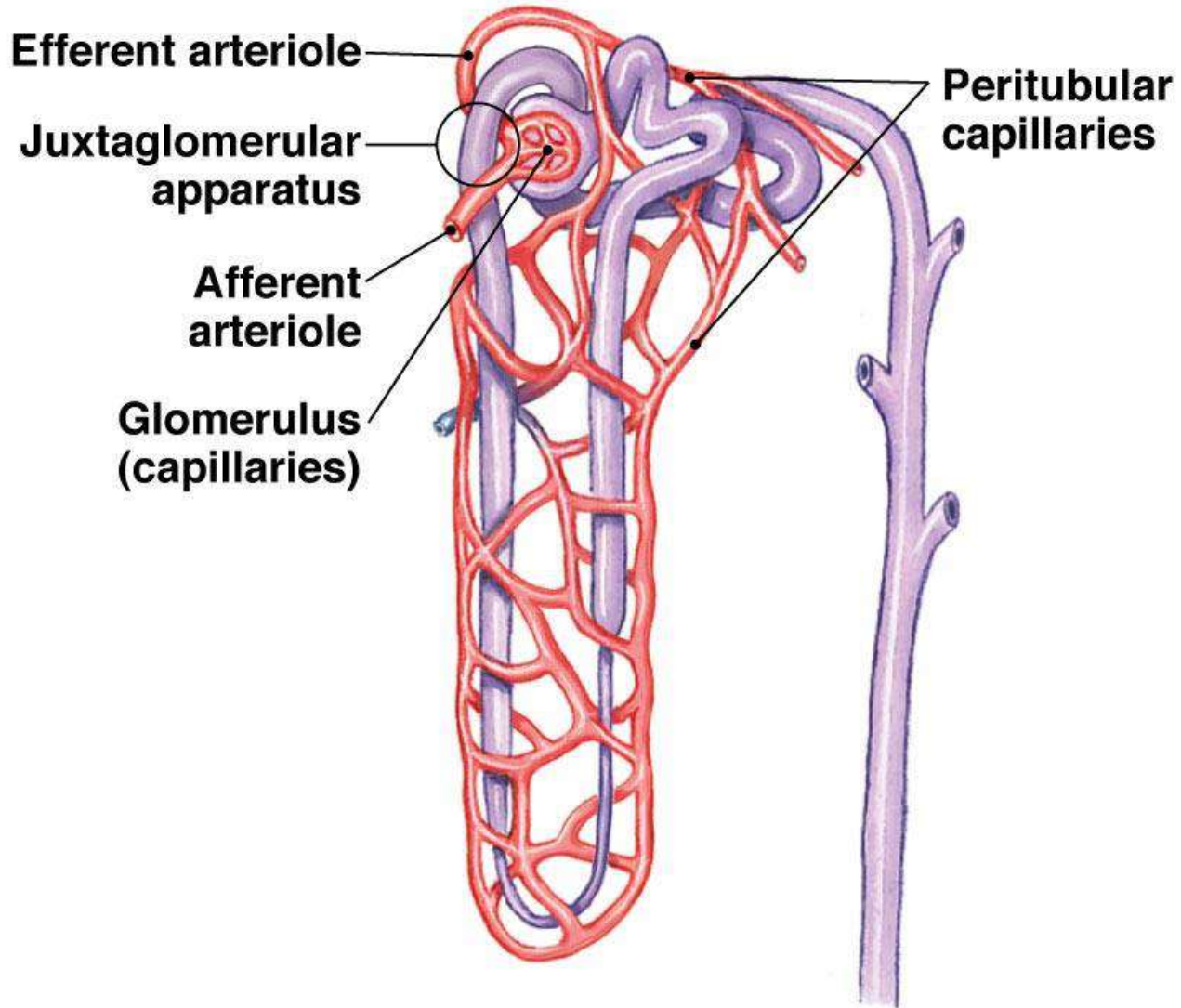

Nephrons - types

- **Cortical nephrons** – 85% of nephrons; located in the cortex
- **Juxtamedullary nephrons: 15%**
 - Are located at the cortex-medulla junction
 - Have nephron loops that deeply invade the medulla
 - Have extensive thin segments
 - Are involved in the production of *concentrated urine*

(i) Some nephrons dip deep into the medulla.

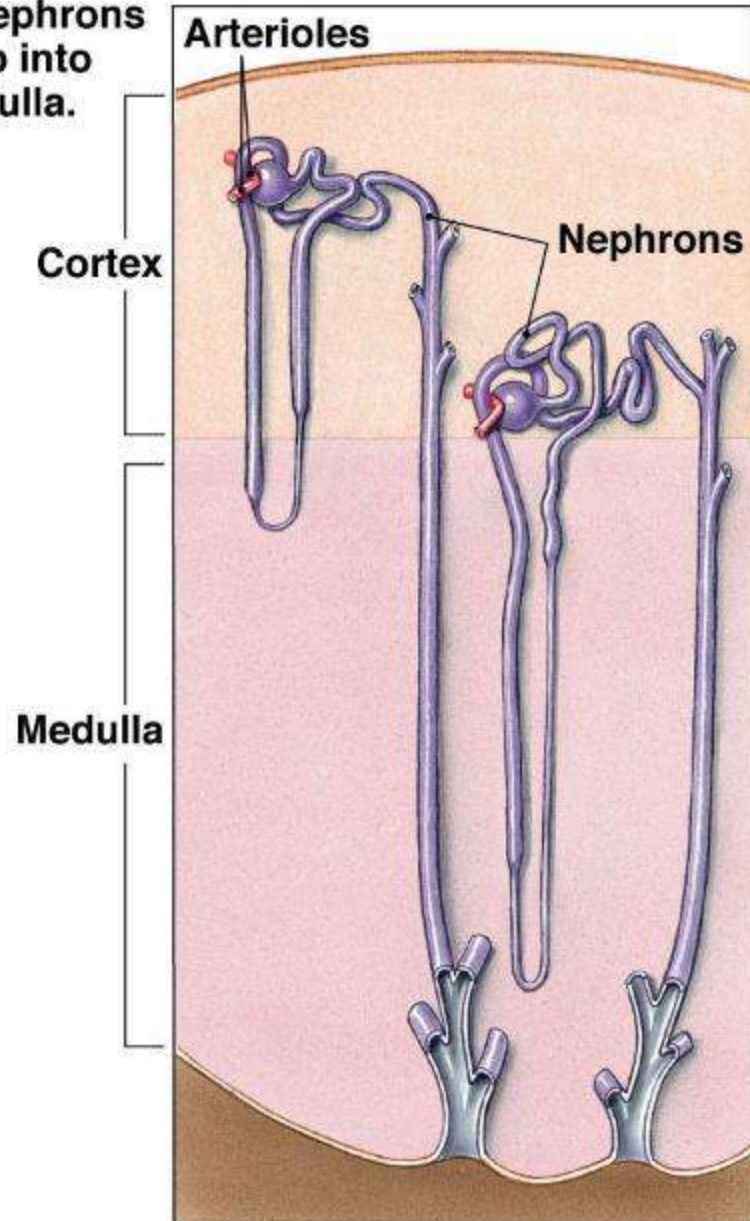

Copyright © 2007 Pearson Education, Inc., publishing as Benjamin Cummings.

Peritubular Capillary Beds

- **Peritubular beds** are low-pressure, porous capillaries adapted for absorption that:
 - Arise from efferent arterioles
 - Cling to adjacent renal tubules
 - Empty into the renal venous system
- ***Vasa recta*** – long, straight efferent arterioles of **juxtamedullary nephrons**

Capillary Beds

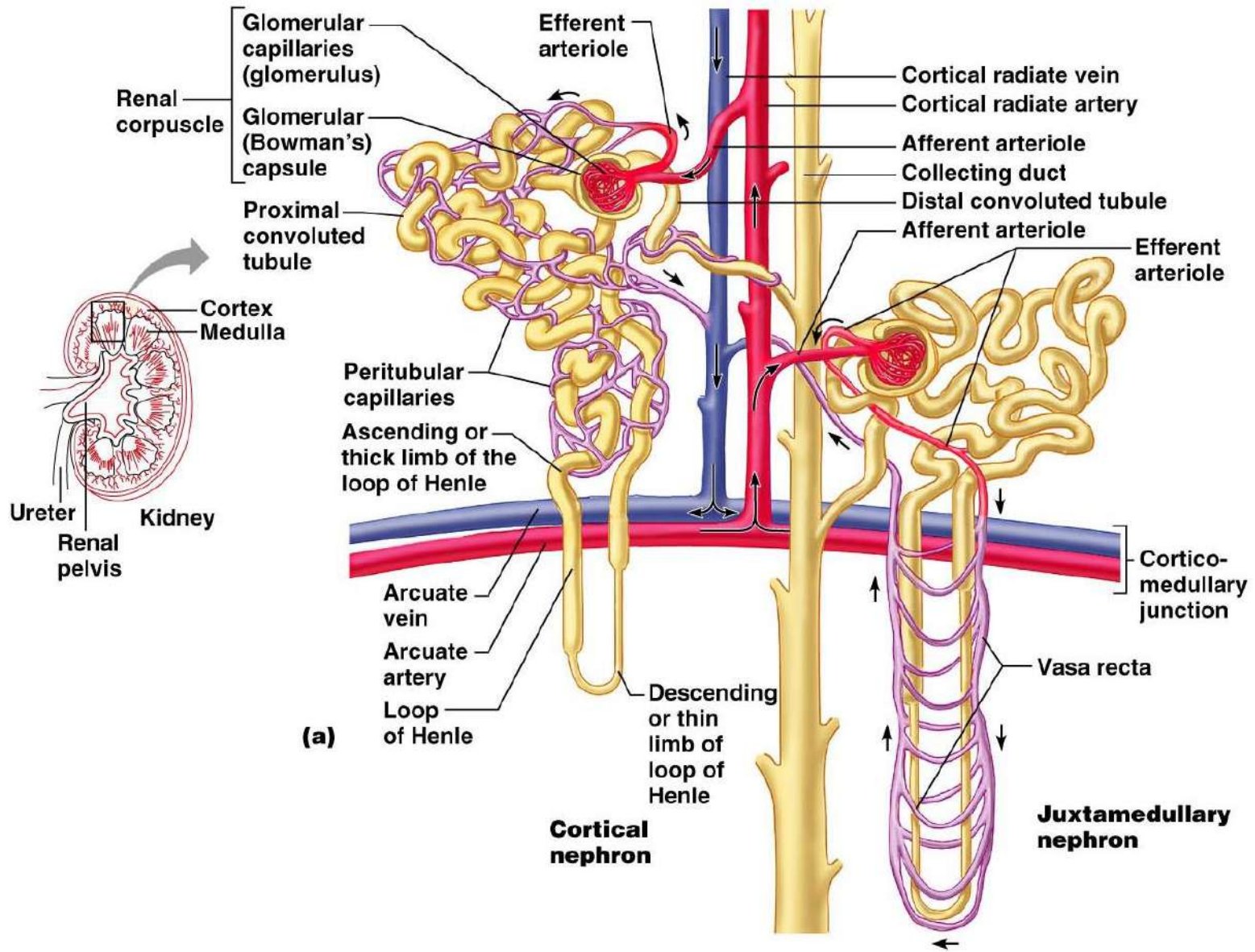

Vascular Resistance in Microcirculation

- **Resistance in afferent arterioles:**
 - Protects glomeruli from fluctuations in systemic blood pressure
- **Resistance in efferent arterioles:**
 - Reinforces high glomerular pressure
 - Reduces hydrostatic pressure in peritubular capillaries

Juxtaglomerular Apparatus (JGA)

- Where the distal tubule lies against the afferent (sometimes efferent) arteriole
- **Arteriole walls** have **juxtaglomerular** (*granular; JG*) cells
 - Enlarged smooth muscle cells
 - Have secretory granules containing the enzyme *renin*
 - Act as mechanoreceptors sensing change in blood pressure

Juxtaglomerular Apparatus (JGA)

- **Macula densa**

- Tall, closely packed **distal tubule cells**
- Lie adjacent to JG cells
- Function as **chemoreceptors to monitor NaCl** in filtrate

- **Extraglomerular Mesangial cells:**

- Have phagocytic and contractile properties
- Pass regulatory signals between macula densa and JG cells.

Juxtaglomerular Apparatus (JGA)

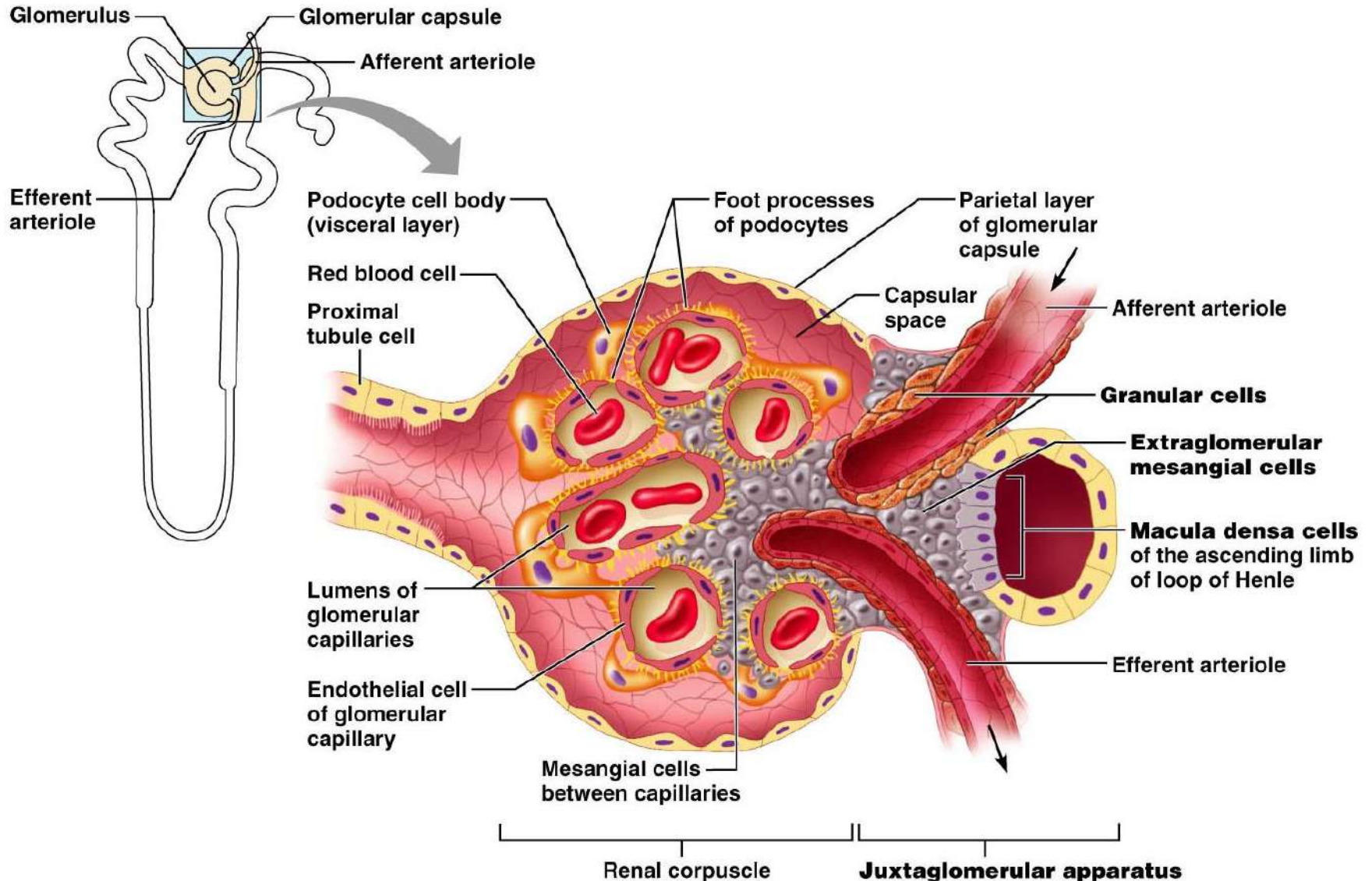

Urine Formation Process

Mechanisms of Urine Formation

- Urine formation and adjustment of blood composition involves three major processes
 - Glomerular filtration
 - Tubular reabsorption
 - Secretion

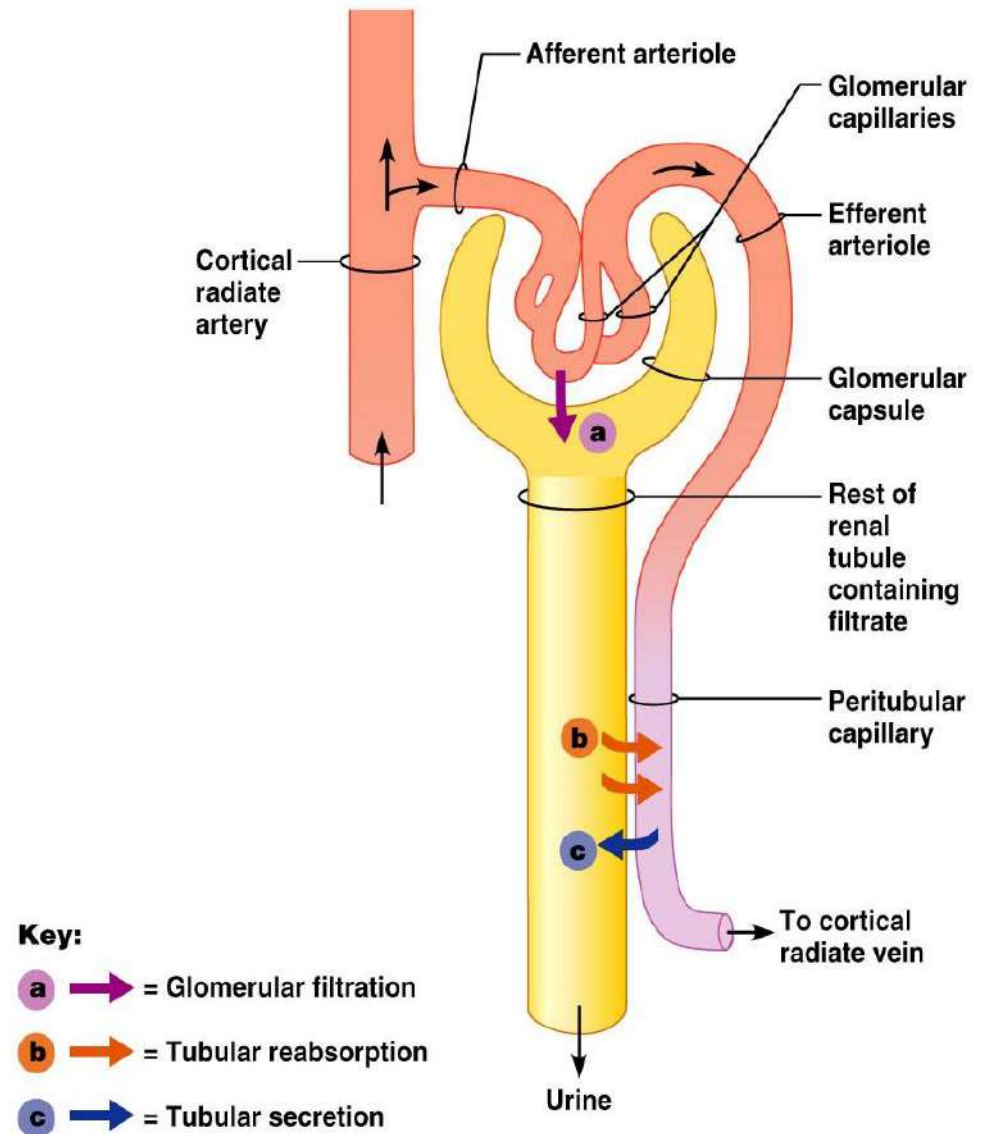
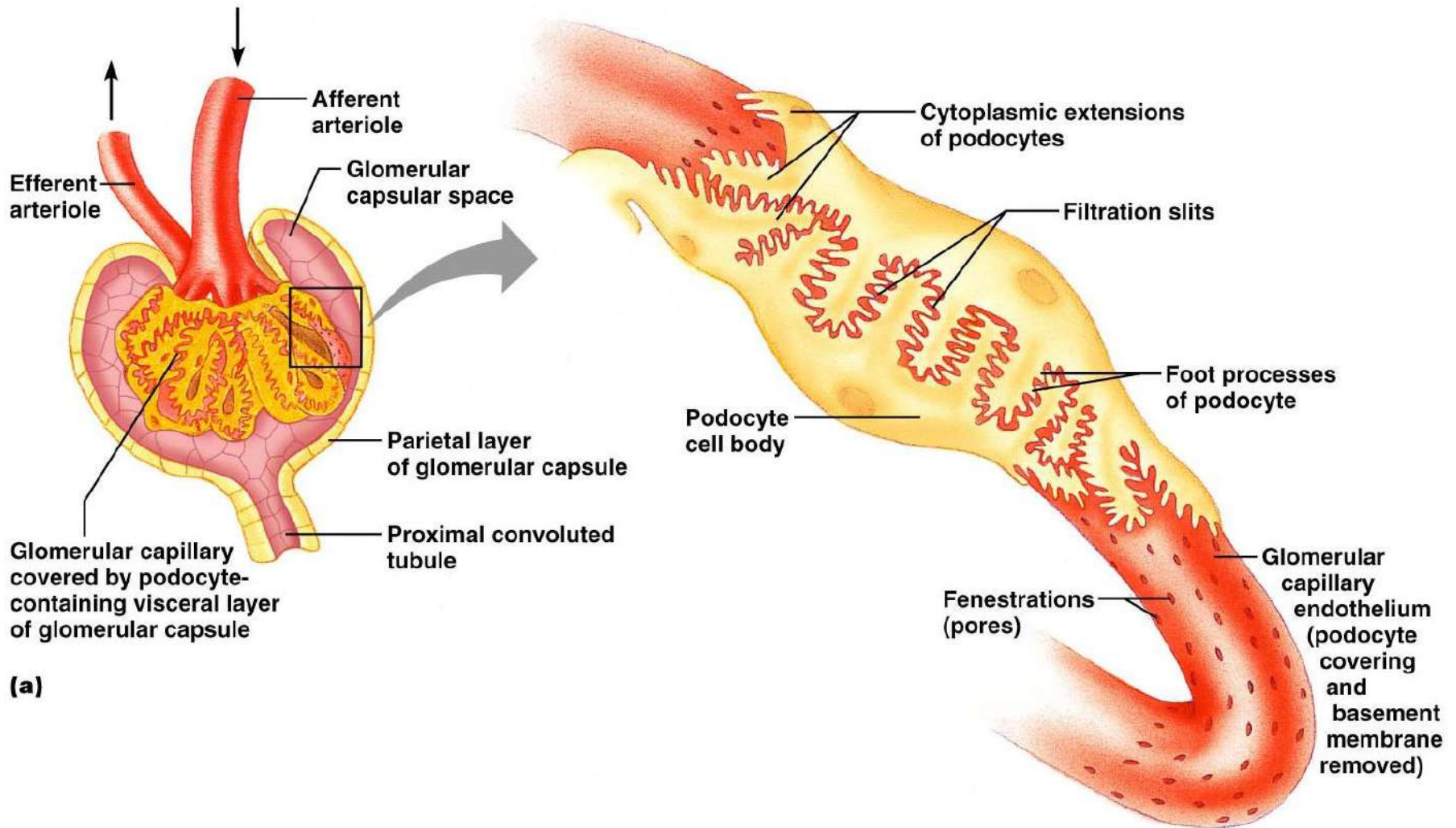

TABLE 19-1**Changes in Filtrate Volume and Osmolarity Along the Nephron**

LOCATION IN NEPHRON	VOLUME OF FLUID	OSMOLARITY OF FLUID
Bowman's capsule	180 L/day	300 mOsM
End of proximal tubule	54 L/day	300 mOsM
End of loop of Henle	18 L/day	100 mOsM
End of collecting duct (final urine)	1.5 L/day (average)	50–1200 mOsM

Copyright © 2007 Pearson Education, Inc., publishing as Benjamin Cummings.

Filtration Membrane



Filtration Membrane

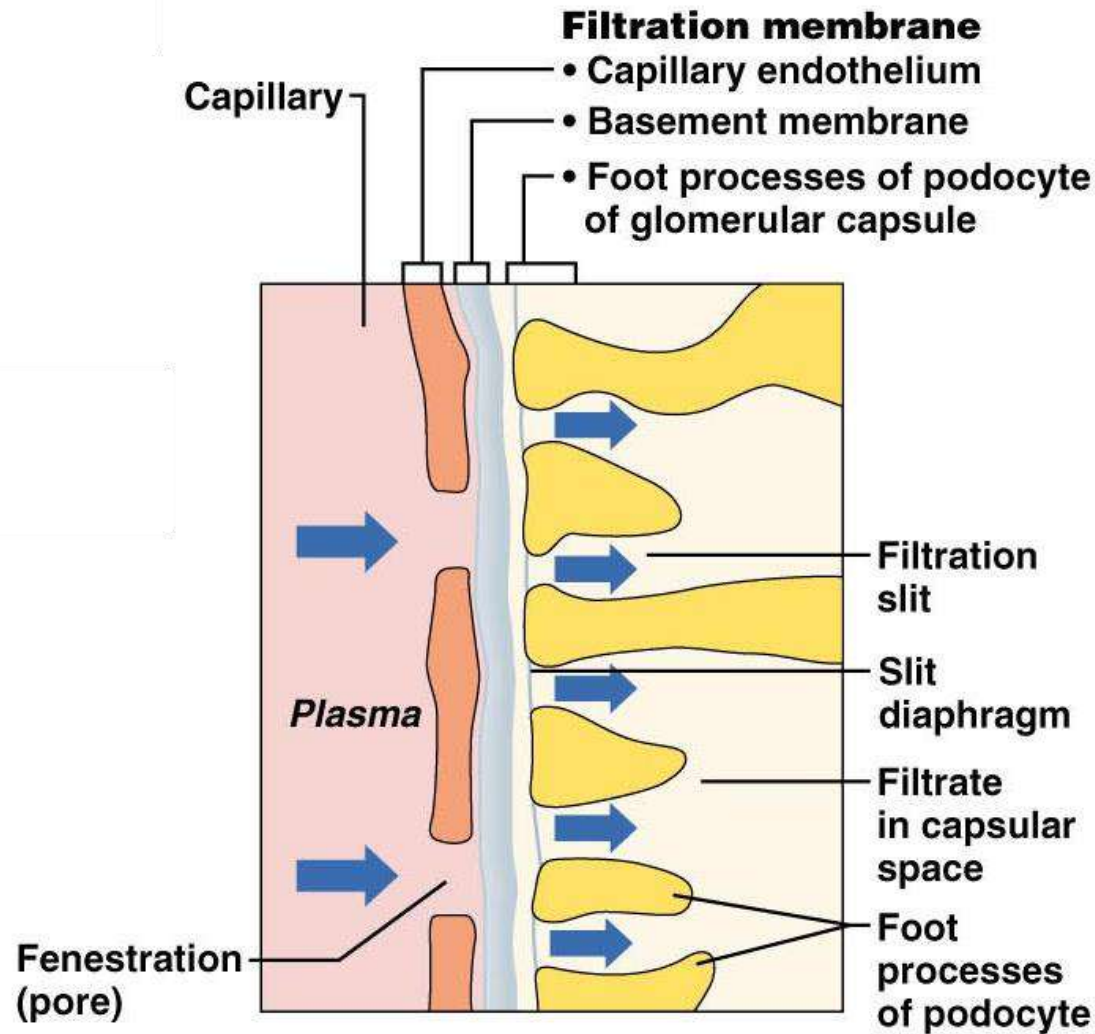

(c)

Mechanisms of Urine Formation

- The kidneys filter the body's entire plasma volume 60 times each day
- The filtrate:
 - Contains all plasma components **EXCEPT PROTEIN**
 - Loses water, nutrients, and essential ions to become urine
- The urine contains metabolic wastes and unneeded substances

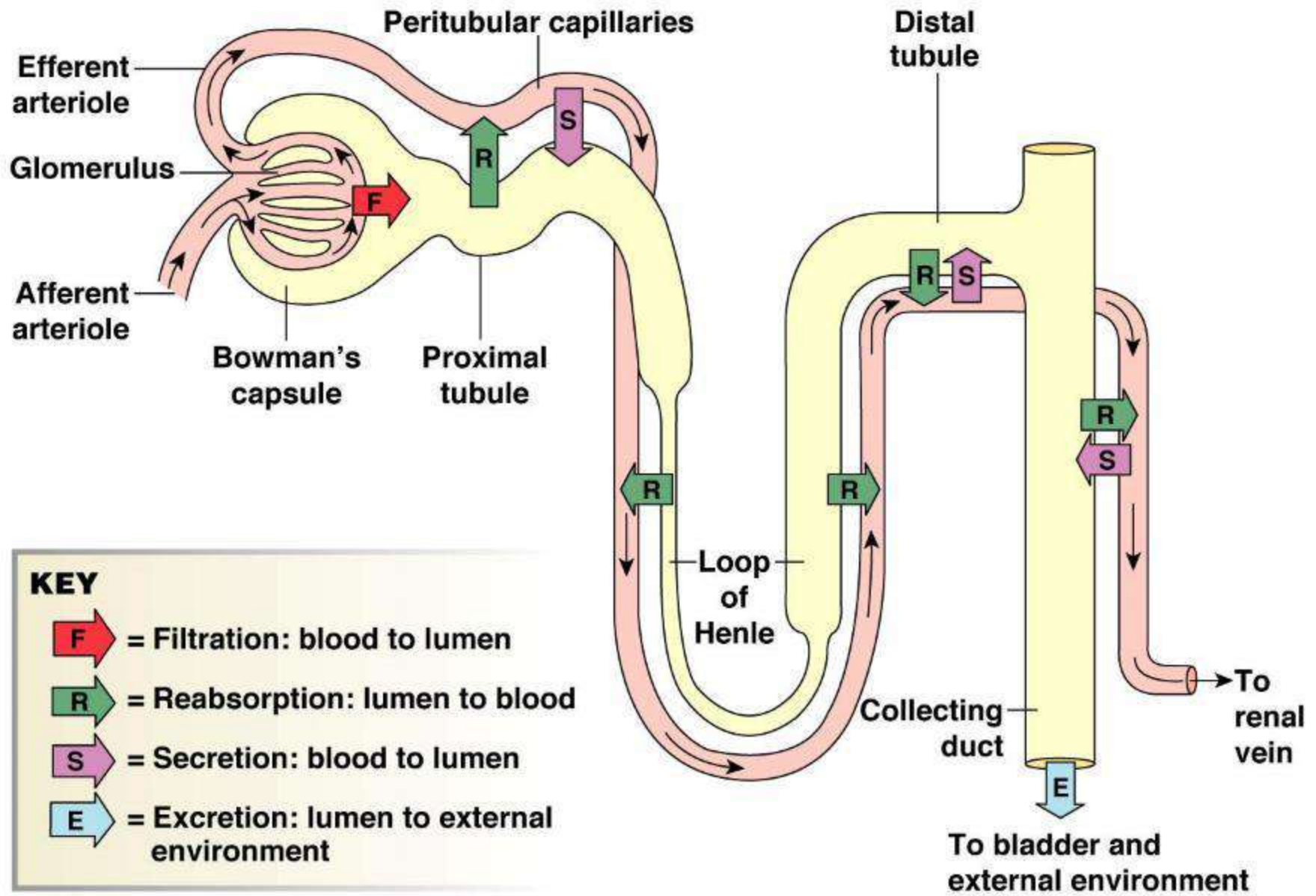

Copyright © 2007 Pearson Education, Inc., publishing as Benjamin Cummings.

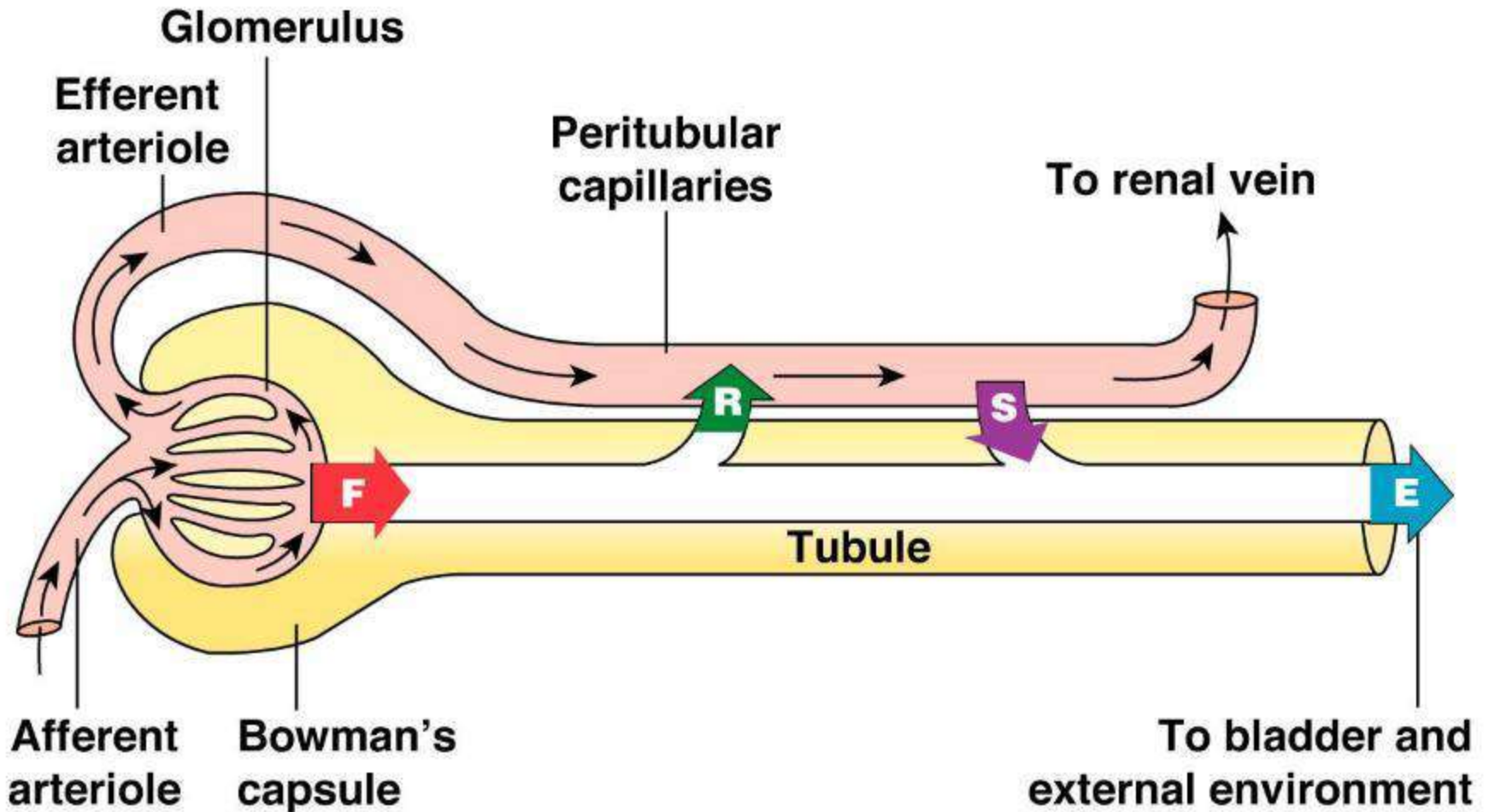

Amount filtered	-	amount reabsorbed	+	amount secreted	=	Amount of solute excreted
F		R		S		E

Copyright © 2007 Pearson Education, Inc., publishing as Benjamin Cummings.

Urine formation:1- Glomerular Filtration

- A passive process in which pressure forces fluids and solutes through a membrane

Pressures affecting filtration (*in mmHg*):

1. Outward forces

- Hydrostatic pressure in glomerular capillaries (55)

2. Inward forces

- Hydrostatic pressure in the capsular space (15)
- The colloid osmotic glomerular pressure (30)

Net Filtration Pressure (NFP) = 10 outward

Glomerular Filtration Rate (GFR)

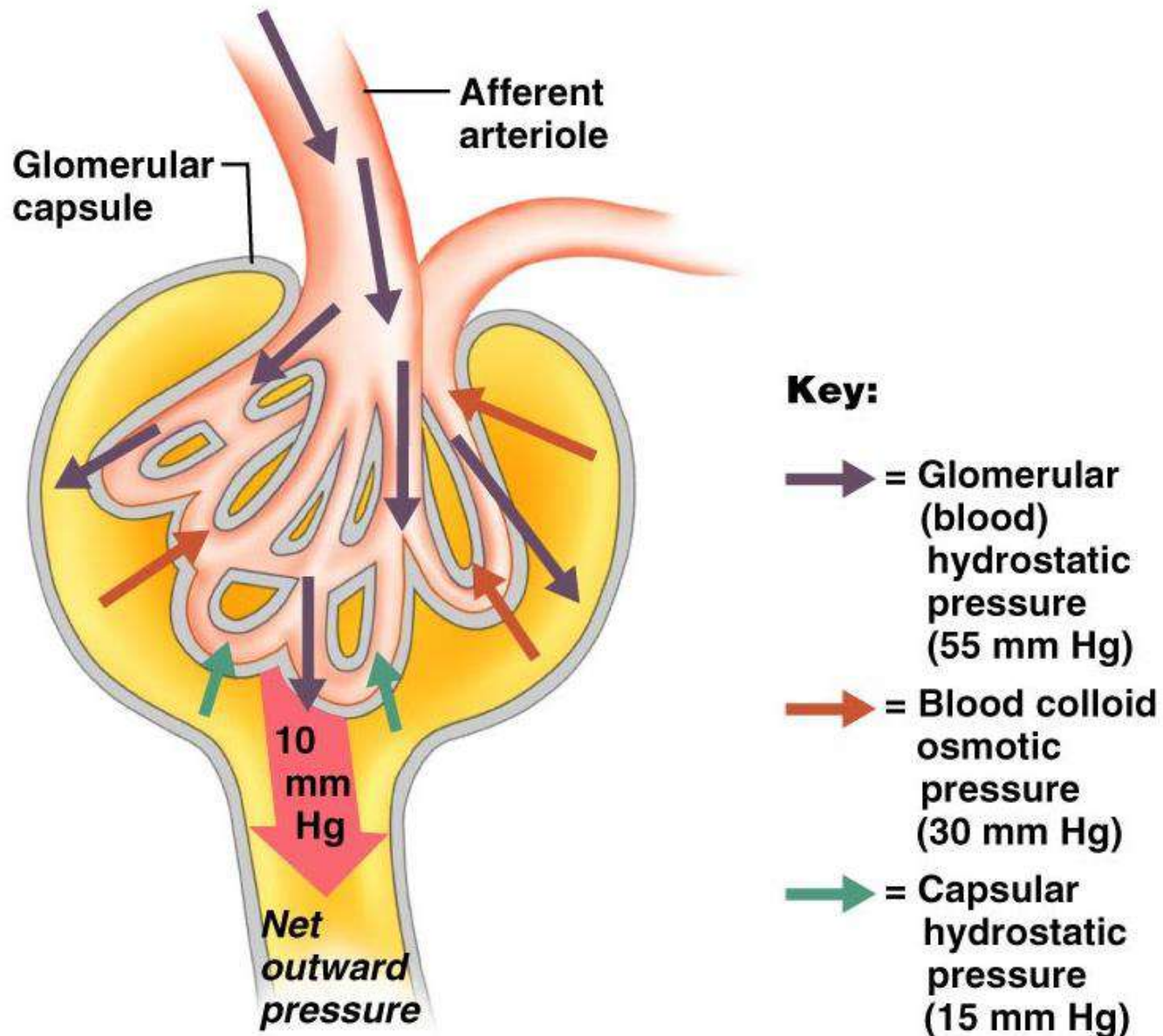

Glomerular Filtration Rate (GFR)

- The total amount of filtrate formed per minute by the kidneys
- Factors governing filtration rate at the capillary bed are:
 - *Net filtration pressure (NFP)*
 - *Total surface area available for filtration*
 - *Filtration membrane permeability*
- GFR is directly proportional to the NFP
- Changes in GFR normally result from changes in glomerular blood pressure

Regulation of Glomerular Filtration

- **If the GFR is too high:**
 - Needed substances cannot be reabsorbed quickly enough and are lost in the urine
- **If the GFR is too low:**
 - Everything is reabsorbed, including wastes that are normally disposed of

Regulation and Control of Glomerular Filtration

Intrinsic Controls

- Under normal conditions, renal autoregulation maintains a nearly constant glomerular filtration rate
- **Autoregulation** entails two types of control
 - **Myogenic** – responds to changes in pressure in the renal blood vessels
 - Flow-dependent **tubuloglomerular feedback** – senses changes in the juxtaglomerular apparatus

Extrinsic Controls

- **Under stress:**
 - **Norepinephrine** is released by the sympathetic nervous system
 - **Epinephrine** is released by the adrenal medulla
 - **Afferent arterioles constrict and filtration is partially inhibited**
- The sympathetic nervous system also stimulates the **renin-angiotensin** mechanism

Renin Release

- Renin release is triggered by:
 - **Sympathetic nerve activation (Direct stimulation of the JG cells via β_1 -adrenergic receptors)**
 - **Renal artery hypotension (caused by systemic hypotension or renal artery stenosis) Reduced stretch of the granular JG cells**
 - **Decreased sodium delivery to the distal tubules of the kidney. Stimulation of the JG cells by activated macula densa cells**

Renin-Angiotensin Mechanism

- Is triggered when **the JG cells release renin**
- Renin converts **angiotensinogen to angiotensin I**
- **Angiotensin I** is converted to **angiotensin II** by **ACE**
- **Angiotensin II**:
 - Causes mean arterial pressure (MAP) to rise
 - Stimulates the adrenal cortex to release **aldosterone**
- As a result, both systemic and glomerular hydrostatic **pressure rise**

Renin Release

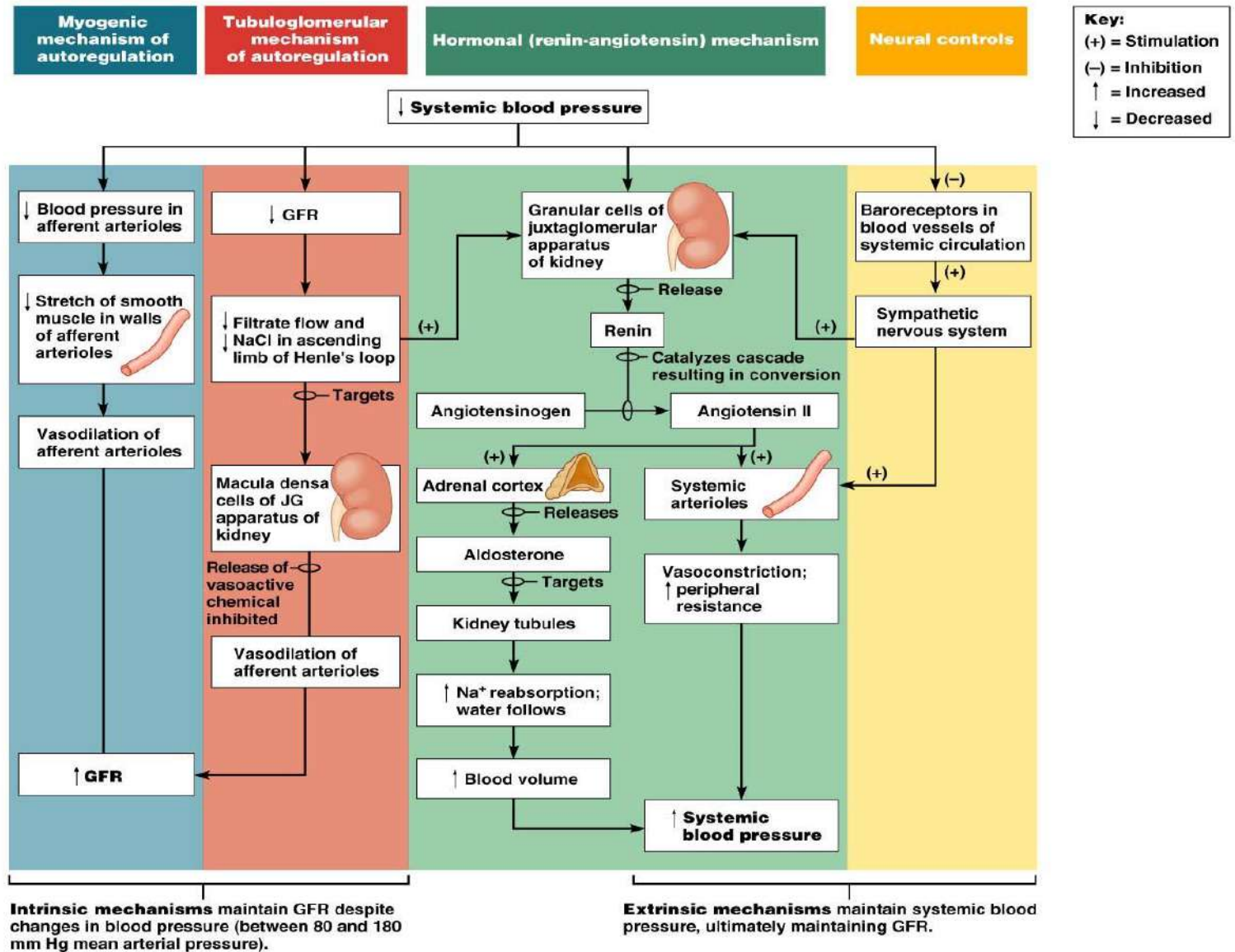

Other Factors Affecting Glomerular Filtration

- **Prostaglandins** (PGE_2 and PGI_2)
 - Are vasodilators produced in response to sympathetic stimulation and angiotensin II
 - Are thought to prevent renal damage when peripheral resistance is increased
- **Nitric oxide** – vasodilator produced by the vascular endothelium
- **Adenosine** – vasoconstrictor of renal vasculature
- **Endothelin** – a powerful **vasoconstrictor** secreted by tubule cells

Urine formation: 2- Tubular Reabsorption

- A transepithelial process whereby most tubule contents are returned to the blood
- Transported substances move through three membranes
 - Luminal and basolateral membranes of tubule cells
 - Endothelium of peritubular capillaries
- Only Ca^{2+} , Mg^{2+} , K^{+} , and some Na^{+} are reabsorbed via *para-cellular* pathways

Tubular Reabsorption

- All organic nutrients are reabsorbed
- Water and ion reabsorption is hormonally controlled
- Reabsorption may be an active (requiring ATP; be primary or secondary) or passive process

Sodium Reabsorption: Primary Active Transport

- Sodium reabsorption is almost always by active transport
 - Na^+ enters the tubule cells at the luminal membrane
 - Is actively transported out of the tubules by a Na^+/K^+ ATPase pump

Sodium Reabsorption: Primary Active Transport

- From there it moves to peritubular capillaries due to:
 - Low hydrostatic pressure
 - High osmotic pressure of the blood
- Na^+ reabsorption provides the energy and the means for reabsorbing most other solutes (Secondary active transport)

Routes of Water and Solute Reabsorption

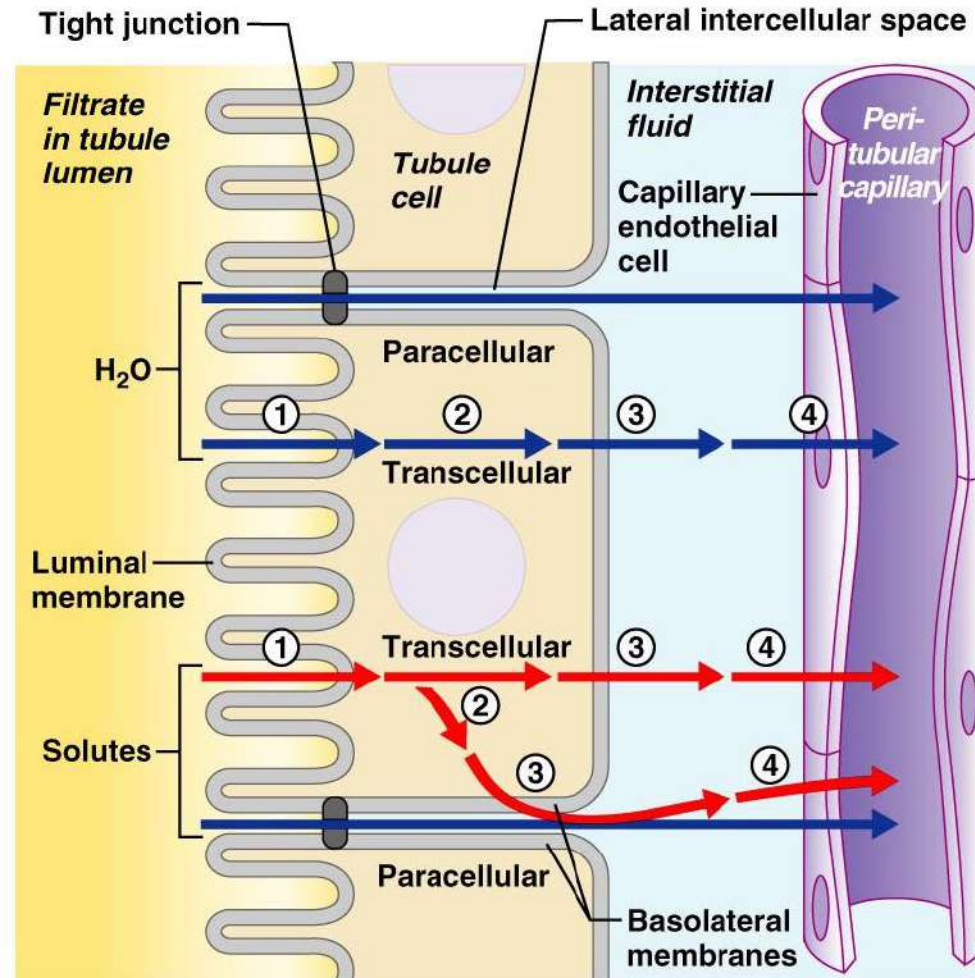

Reabsorption by PCT Cells

- Active pumping of Na^+ drives reabsorption of:
 - Water by osmosis, aided by water-filled pores called aquaporins
 - Fat-soluble substances by diffusion
 - Organic nutrients and selected cations by secondary active transport

Reabsorption by PCT Cells

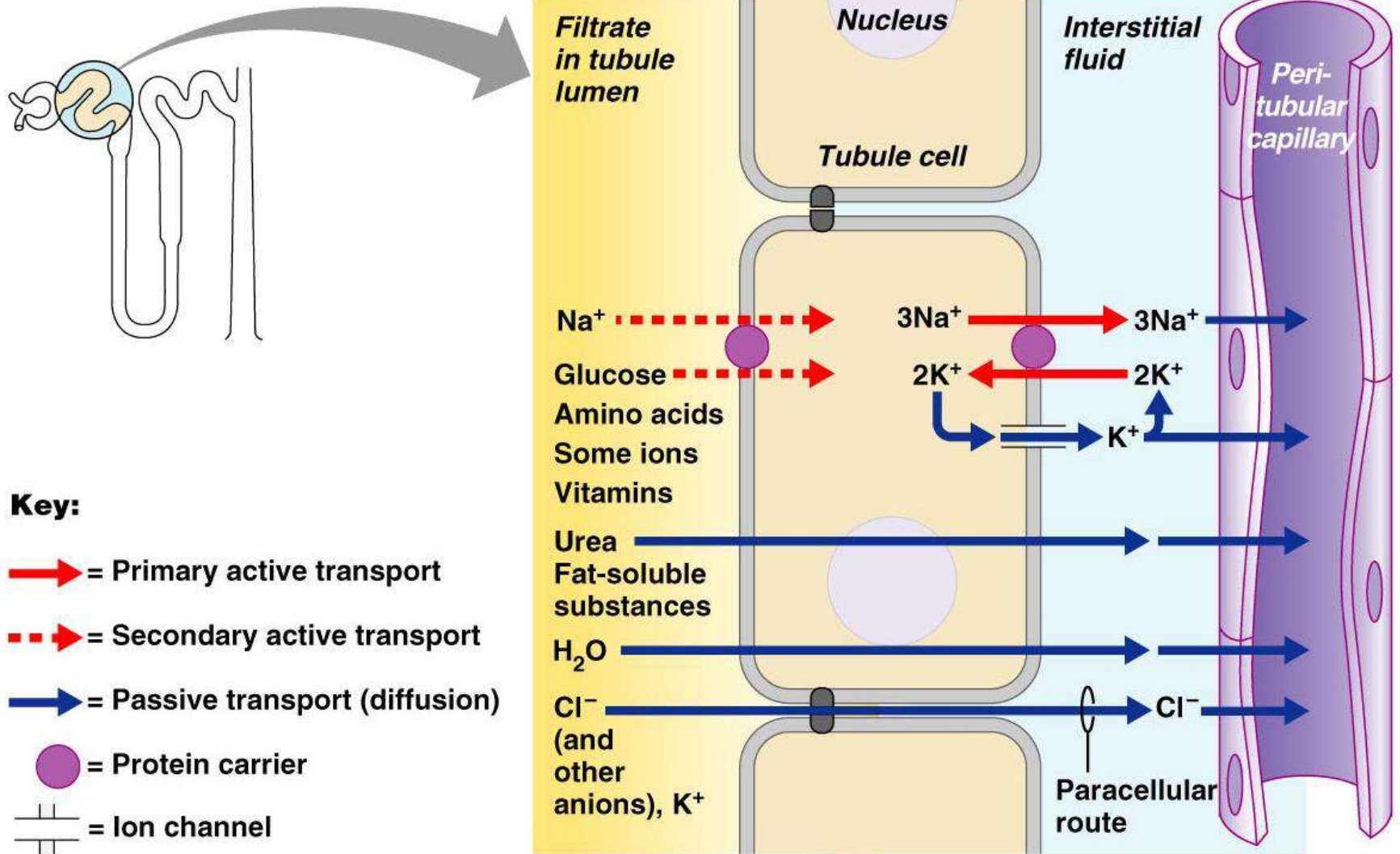

Non-reabsorbed Substances

- **A transport maximum (T_m):**
 - Reflects the number of carriers in the renal tubules available
 - Exists for nearly every substance that is actively reabsorbed
- When the carriers are saturated, excess of that substance is excreted

Non-reabsorbed Substances

- Substances are not reabsorbed if they:
 - Lack carriers
 - Are not lipid soluble
 - Are too large to pass through membrane pores
- Creatinine, and uric acid are the most important non-reabsorbed substances

Absorptive Capabilities of Renal Tubules

- Substances reabsorbed in PCT include:
 - Sodium, all nutrients, cations, anions, and water
 - Urea and lipid-soluble solutes
 - Small proteins
- Loop of Henle reabsorbs:
 - H_2O , Na^+ , Cl^- , K^+ in the descending limb
 - Ca^{2+} , Mg^{2+} , and Na^+ in the ascending limb

Absorptive Capabilities of Renal tubules (Cont'd) and Collecting Ducts

- DCT absorbs:
 - Ca^{2+} , Na^{+} , H^{+} , K^{+} , and water
 - HCO_3^{-} and Cl^{-}
- Collecting duct absorbs:
 - Water and urea

Na⁺ Entry into Tubule Cells

- Na⁺-K⁺ ATPase pump
- In the PCT: facilitated diffusion using symport and antiport carriers
- In the ascending loop of Henle: facilitated diffusion via Na⁺-K⁺-2Cl⁻ symport system
- In the DCT: Na⁺-Cl⁻ symporter
- In collecting tubules: diffusion through membrane pores

Atrial Natriuretic Peptide (ANP) Activity

- ANP reduces blood Na^+ which:
 - Decreases blood volume
 - Lowers blood pressure
- ANP lowers blood Na^+ by:
 - Acting directly on medullary ducts to inhibit Na^+ reabsorption
 - Counteracting the effects of angiotensin II
 - Indirectly stimulating an increase in GFR and reducing water reabsorption

Urine formation: 3- Tubular Secretion

- Essentially reabsorption in reverse, where substances move from peritubular capillaries or tubule cells into filtrate
- Tubular secretion is important for:
 - Disposing of substances not already in the filtrate
 - Eliminating undesirable substances such as urea and uric acid
 - Removal of the body of excess potassium ions
 - Controlling blood pH

Regulation of Urine Concentration and Volume

- Osmolarity
 - The number of solute particles dissolved in 1L of water
 - Reflects the solution's ability to cause osmosis
- Body fluids are measured in milliosmols (mOsm)
- The kidneys keep the solute load of body fluids constant at about 300 mOsm
- This is accomplished by the countercurrent mechanism

Countercurrent Mechanism

- Interaction between the flow of filtrate through the loop of Henle (countercurrent multiplier) and the flow of blood through the vasa recta blood vessels (countercurrent exchanger)
- The solute concentration in the loop of Henle ranges from 300 mOsm to 1200 mOsm
- Dissipation of the medullary osmotic gradient is prevented because the blood in the vasa recta equilibrates with the interstitial fluid

Osmotic Gradient in the Renal Medulla

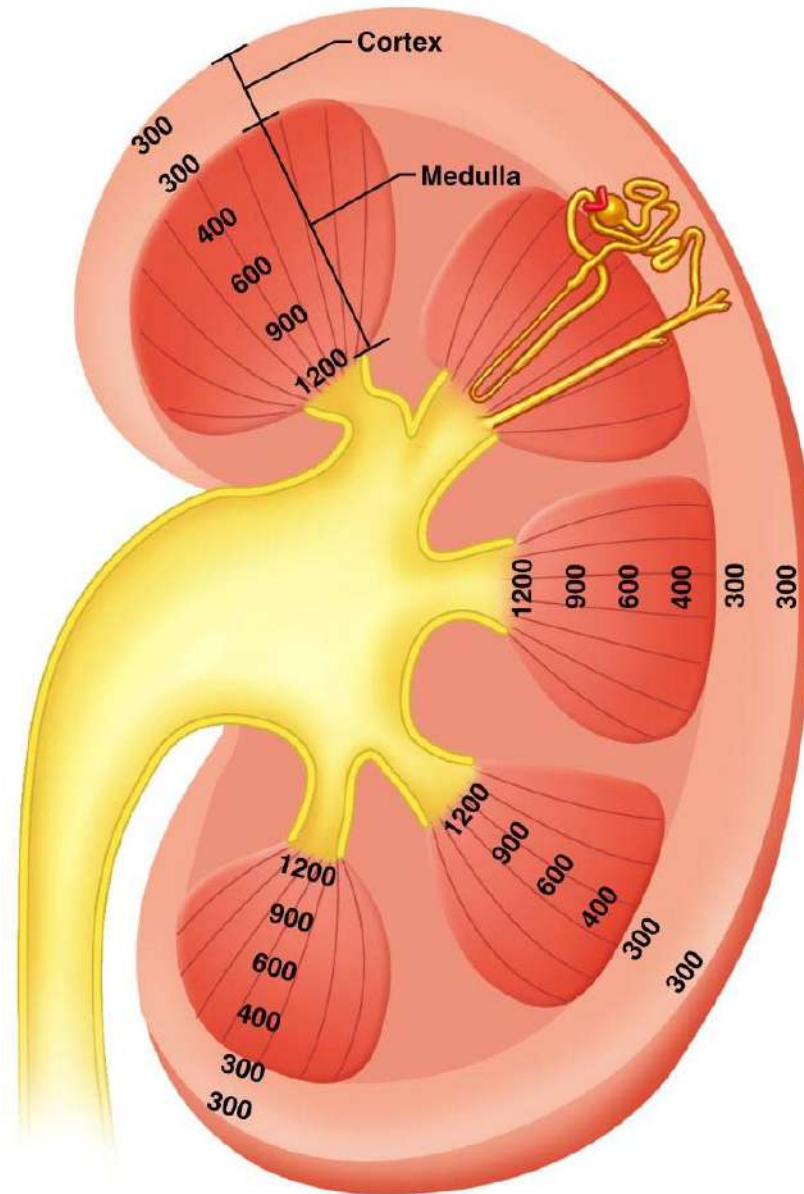

Loop of Henle: Countercurrent Multiplier

- The descending loop of Henle:
 - Is relatively impermeable to solutes
 - Is permeable to water
- The ascending loop of Henle:
 - Is permeable to solutes
 - Is impermeable to water
- Collecting ducts in the deep medullary regions are permeable to urea

Loop of Henle: Countercurrent Exchanger

- The vasa recta is a countercurrent exchanger that:
 - Maintains the osmotic gradient
 - Delivers blood to the cells in the area

Loop of Henle: Countercurrent Mechanism

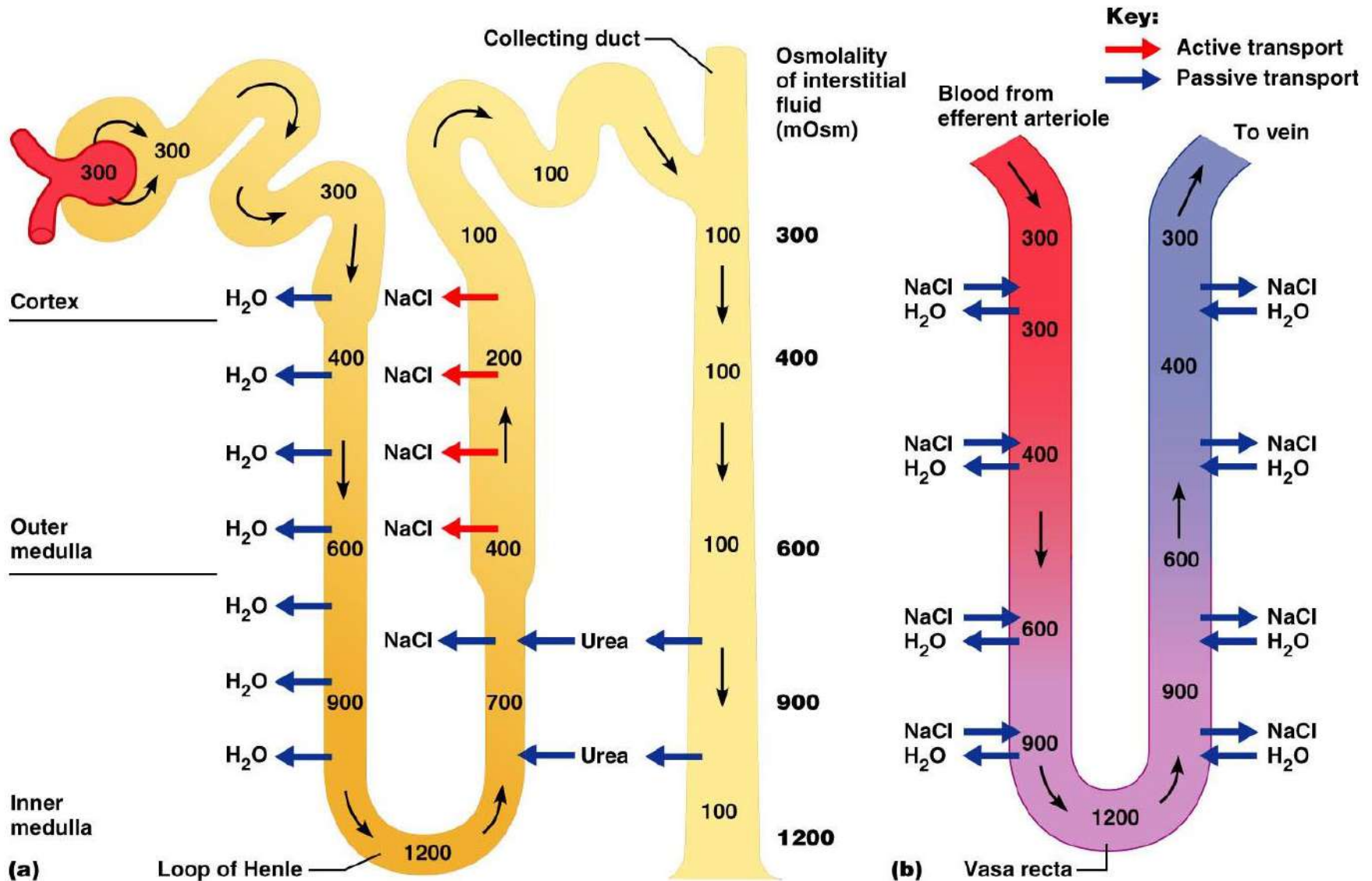

Formation of Dilute Urine

- Filtrate is diluted in the ascending loop of Henle
- Dilute urine is created by allowing this filtrate to continue into the renal pelvis
- This will happen as long as antidiuretic hormone (ADH) is not being secreted

Formation of Dilute Urine

- Collecting ducts remain impermeable to water; no further water reabsorption occurs
- Sodium and selected ions can be removed by active and passive mechanisms
- Urine osmolality can be as low as 50 mOsm (one-sixth that of plasma)

Formation of Concentrated Urine

- Antidiuretic hormone (ADH) inhibits diuresis
- This equalizes the osmolality of the filtrate and the interstitial fluid
- In the presence of ADH, 99% of the water in filtrate is reabsorbed

Formation of Concentrated Urine

- ADH-dependent water reabsorption is called facultative water reabsorption
- ADH is the signal to produce concentrated urine
- The kidneys' ability to respond depends upon the high medullary osmotic gradient

Formation of Dilute and Concentrated Urine

Key:

- Active transport
- Passive transport

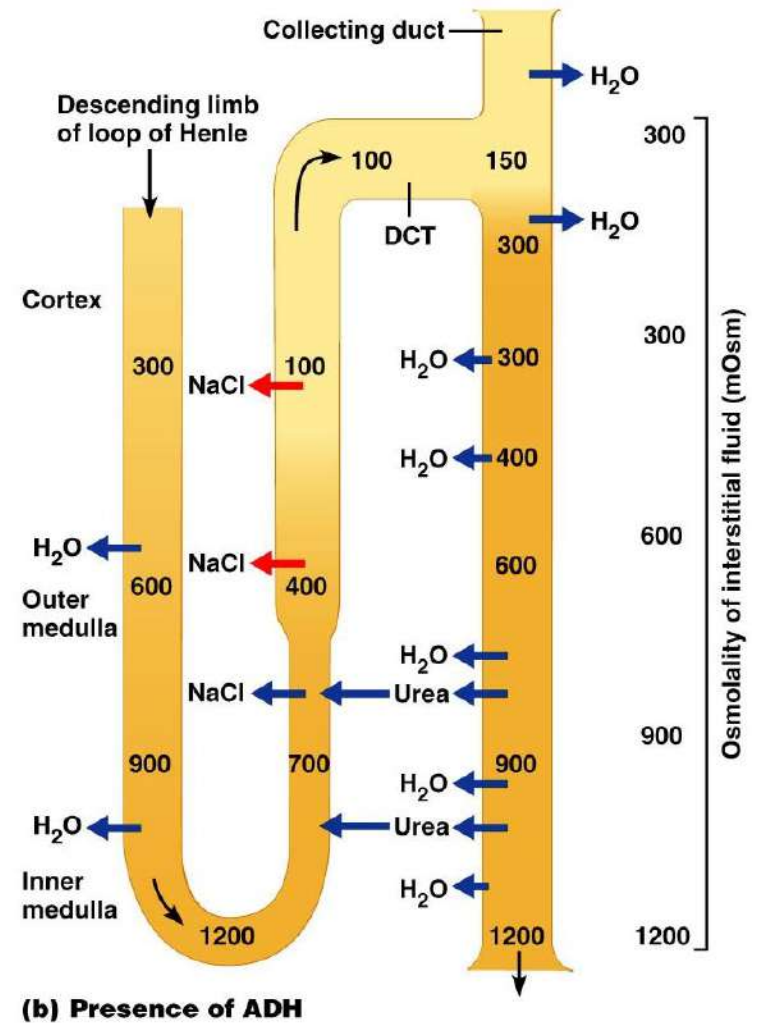
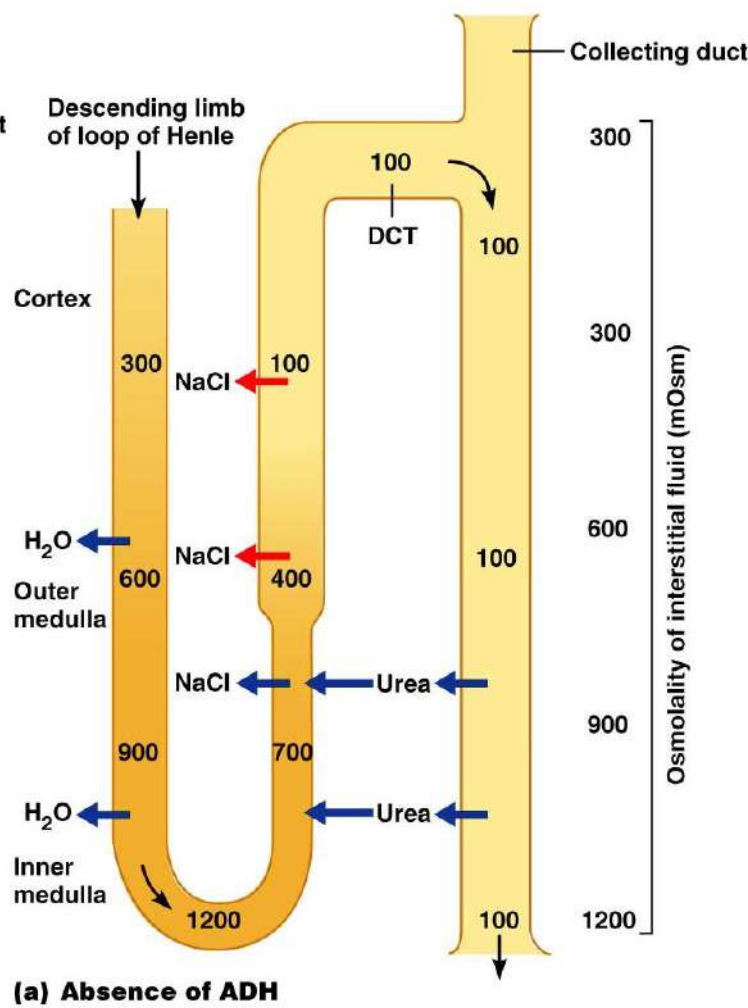

Diuretics

- Chemicals that enhance the urinary output include:
 - Any substance not reabsorbed
 - Substances that exceed the ability of the renal tubules to reabsorb it
 - Substances that inhibit Na^+ reabsorption

Diuretics

- Osmotic diuretics include:
 - High glucose levels – carries water out with the glucose
 - Alcohol – inhibits the release of ADH
 - Caffeine and most diuretic drugs – inhibit sodium ion reabsorption
 - Lasix and Diuril – inhibit Na⁺-associated symporters

Summary of Nephron Function

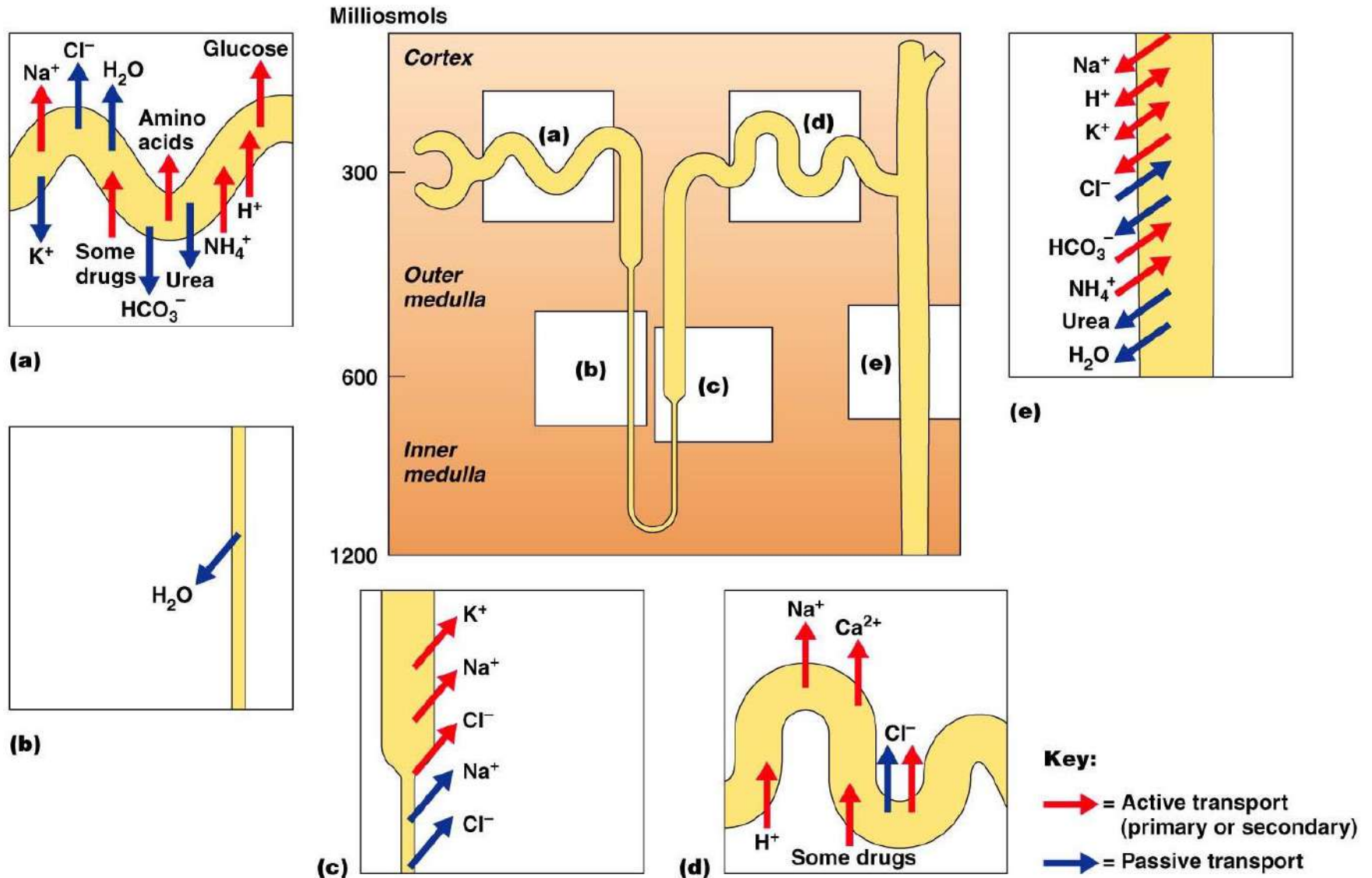

Renal Clearance

- The volume of plasma that is cleared of a particular substance in a given time
- Renal clearance tests are used to:
 - Determine the GFR
 - Detect glomerular damage
 - Follow the progress of diagnosed renal disease

Renal Clearance

$$RC = UV/P$$

RC = renal clearance rate

U = concentration (mg/ml) of the substance in urine

V = flow rate of urine formation (ml/min)

P = concentration of the same substance in plasma

Physical Characteristics of Urine

- Color and transparency
 - Clear, pale to deep yellow (due to urochrome)
 - Concentrated urine has a deeper yellow color
 - Drugs, vitamin supplements, and diet can change the color of urine
 - Cloudy urine may indicate infection of the urinary tract

Physical Characteristics of Urine

- Odor
 - Fresh urine is slightly aromatic
 - Standing urine develops an ammonia odor
 - Some drugs and vegetables (asparagus) alter the usual odor

Physical Characteristics of Urine

- pH
 - Slightly acidic (pH 6) with a range of 4.5 to 8.0
 - Diet can alter pH
- Specific gravity
 - Ranges from 1.001 to 1.035
 - Is dependent on solute concentration

Chemical Composition of Urine

- Urine is 95% water and 5% solutes
- Nitrogenous wastes: urea, uric acid, and creatinine
- Other normal solutes include:
 - Sodium, potassium, phosphate, and sulfate ions
 - Calcium, magnesium, and bicarbonate ions
- Abnormally high concentrations of any urinary constituents may indicate pathology

Ureters

- Slender tubes that convey urine from the kidneys to the bladder
- Ureters enter the base of the bladder through the posterior wall
 - This closes their distal ends as bladder pressure increases and prevents backflow of urine into the ureters

Ureters

- Ureters have a trilayered wall
 - Transitional epithelial mucosa
 - Smooth muscle muscularis
 - Fibrous connective tissue adventitia
- Ureters actively propel urine to the bladder via response to smooth muscle stretch

Urinary Bladder

- Smooth, collapsible, muscular sac that stores urine
- It lies retroperitoneally on the pelvic floor posterior to the pubic symphysis
 - Males – prostate gland surrounds the neck inferiorly
 - Females – anterior to the vagina and uterus
- Trigone – triangular area outlined by the openings for the ureters and the urethra
 - Clinically important because infections tend to persist in this region

Urinary Bladder

- The bladder wall has three layers
 - Transitional epithelial mucosa
 - A thick muscular layer
 - A fibrous adventitia
- The bladder is distensible and collapses when empty
- As urine accumulates, the bladder expands without significant rise in internal pressure

Urinary Bladder

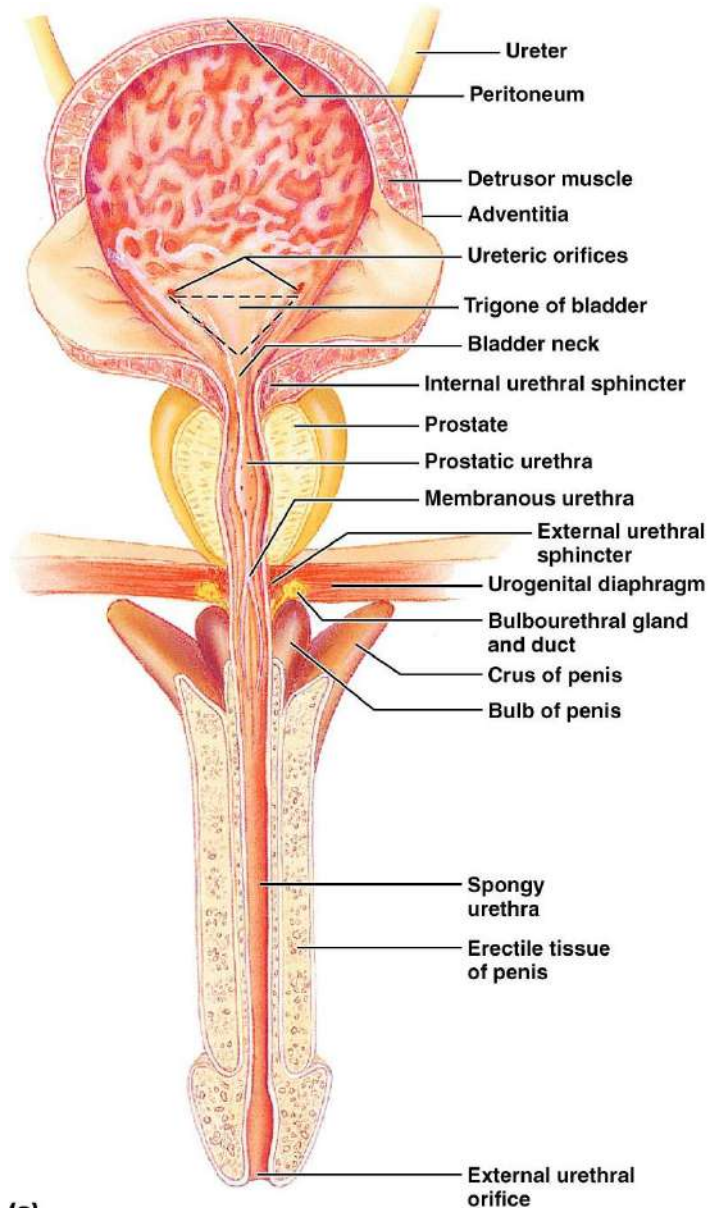

(a)

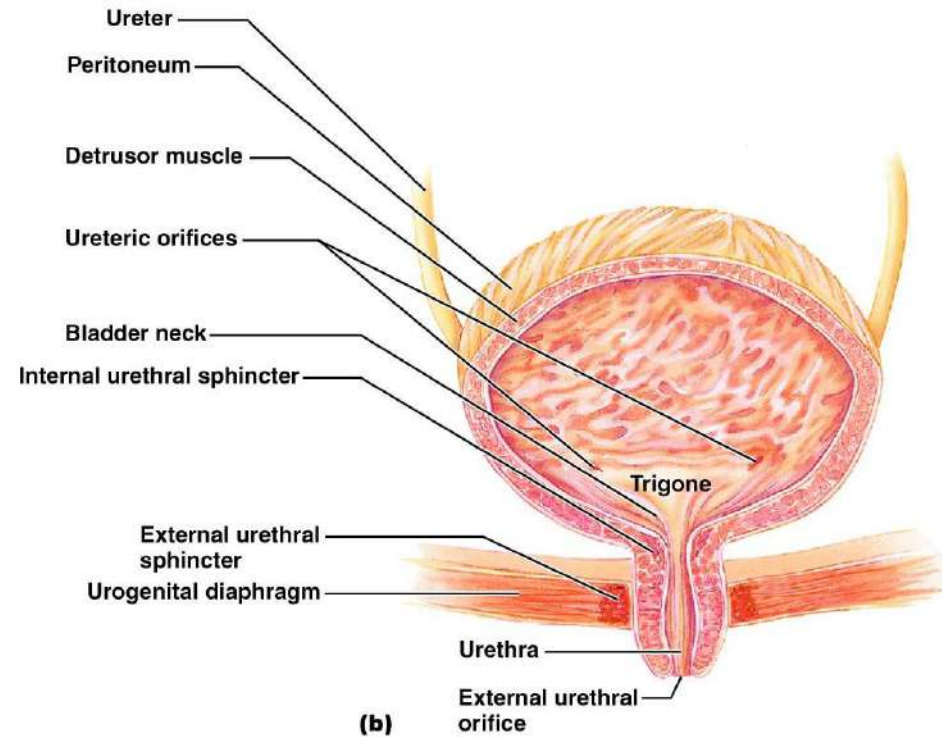

(b)

Urethra

- Muscular tube that:
 - Drains urine from the bladder
 - Conveys it out of the body

Urethra

- Sphincters keep the urethra closed when urine is not being passed
 - Internal urethral sphincter – involuntary sphincter at the bladder-urethra junction
 - External urethral sphincter – voluntary sphincter surrounding the urethra as it passes through the urogenital diaphragm
 - Levator ani muscle – voluntary urethral sphincter

Urethra

- The female urethra is tightly bound to the anterior vaginal wall
- Its external opening lies anterior to the vaginal opening and posterior to the clitoris
- The male urethra has three named regions
 - Prostatic urethra – runs within the prostate gland
 - Membranous urethra – runs through the urogenital diaphragm
 - Spongy (penile) urethra – passes through the penis and opens via the external urethral orifice

Urethra

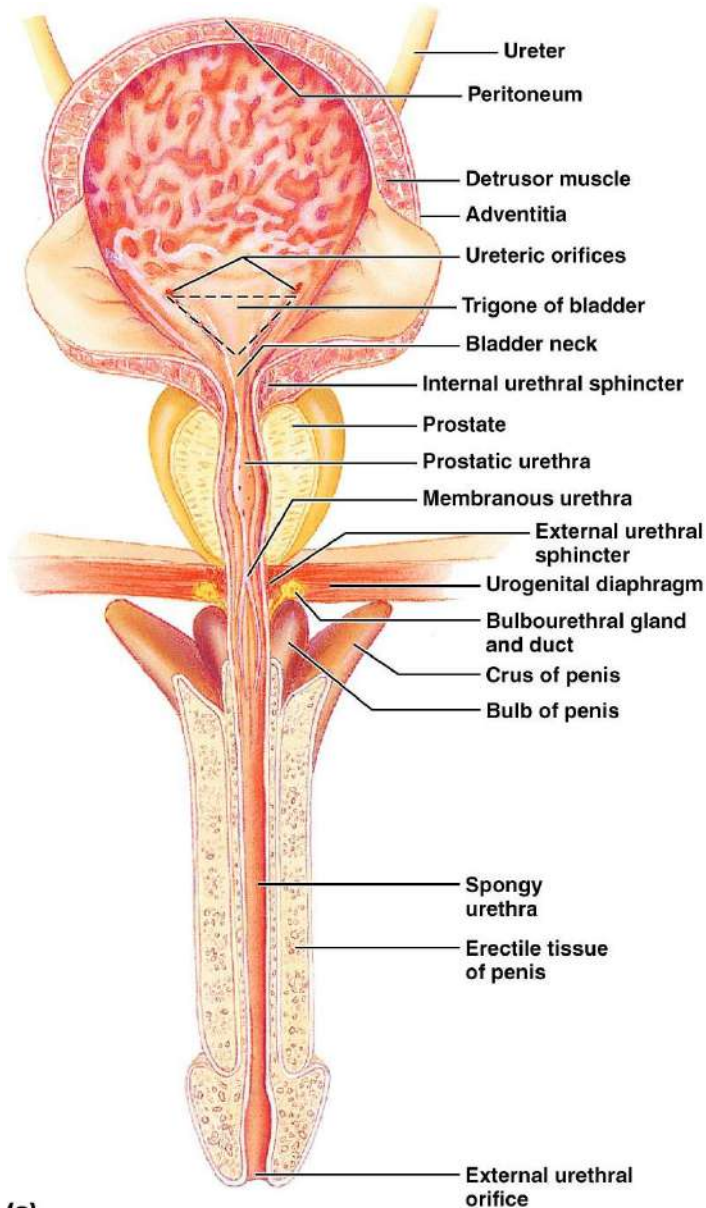

(a)

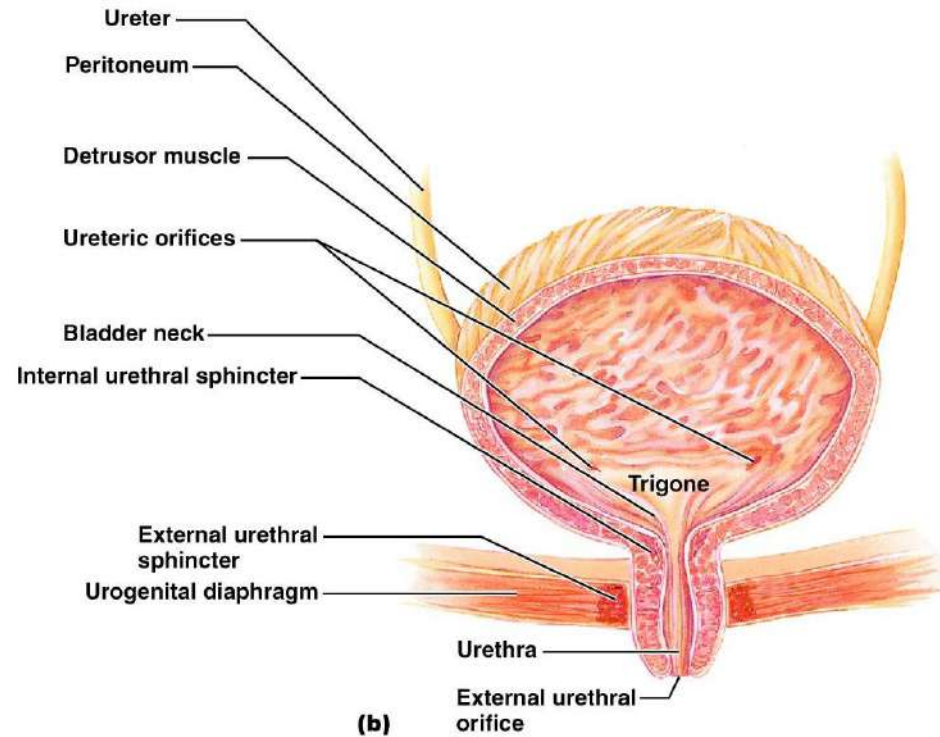

(b)

Micturition (Voiding or Urination)

- The act of emptying the bladder
- Distension of bladder walls initiates spinal reflexes that:
 - Stimulate contraction of the external urethral sphincter
 - Inhibit the detrusor muscle and internal sphincter (temporarily)
- Voiding reflexes:
 - Stimulate the detrusor muscle to contract
 - Inhibit the internal and external sphincters

Neural Circuits Controlling Micturition

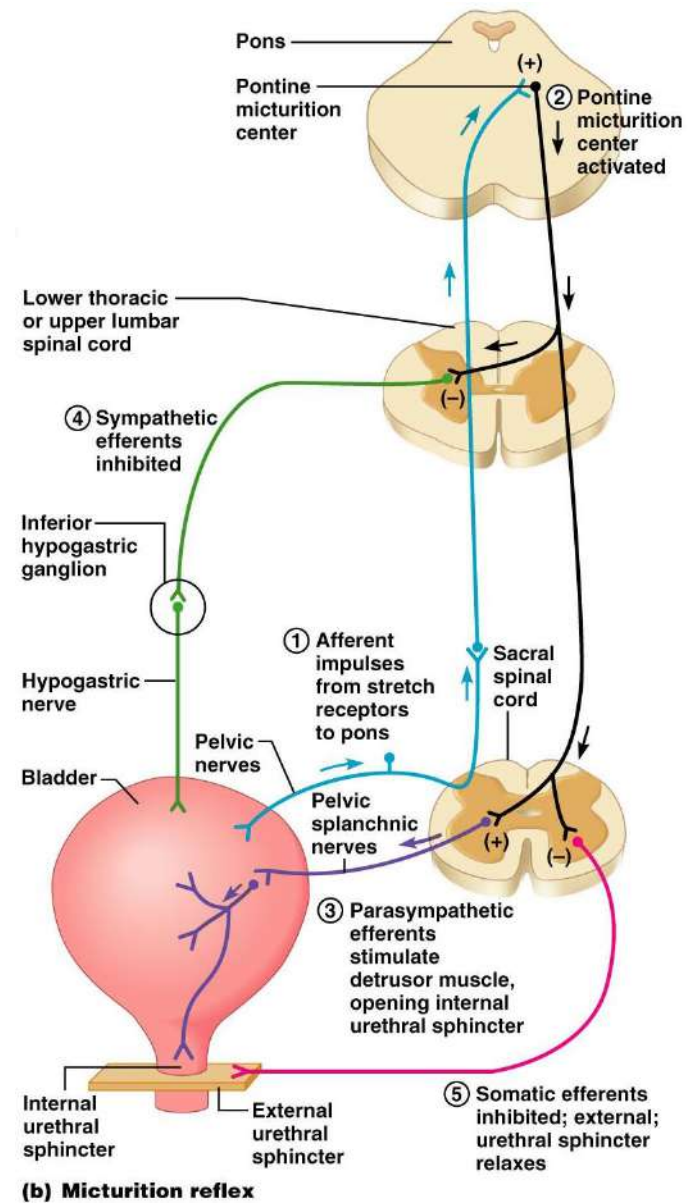
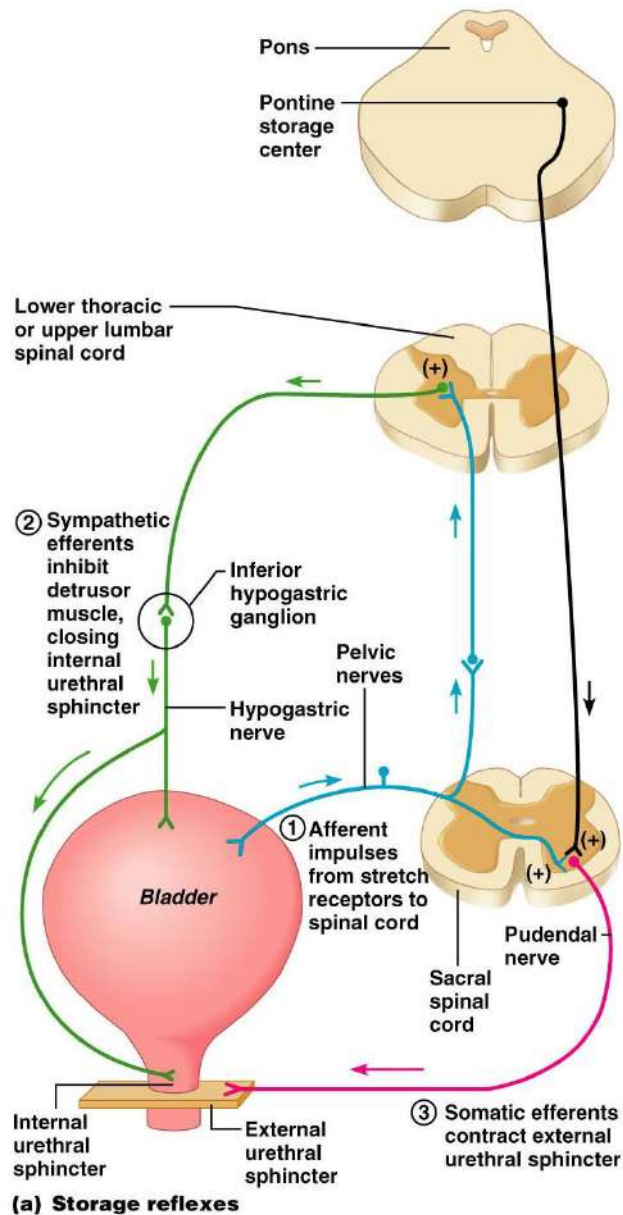

Chemical Composition of Urine

- Urine is **95% water and 5% solutes**
- Nitrogenous wastes: **urea, uric acid, and creatinine**
- Other normal solutes include:
 - **Sodium, potassium, phosphate, and sulfate ions**
 - **Calcium, magnesium, and bicarbonate ions**
- Abnormally high concentrations of any urinary
- constituents may indicate pathology