

# X-ray Lab, Room 117

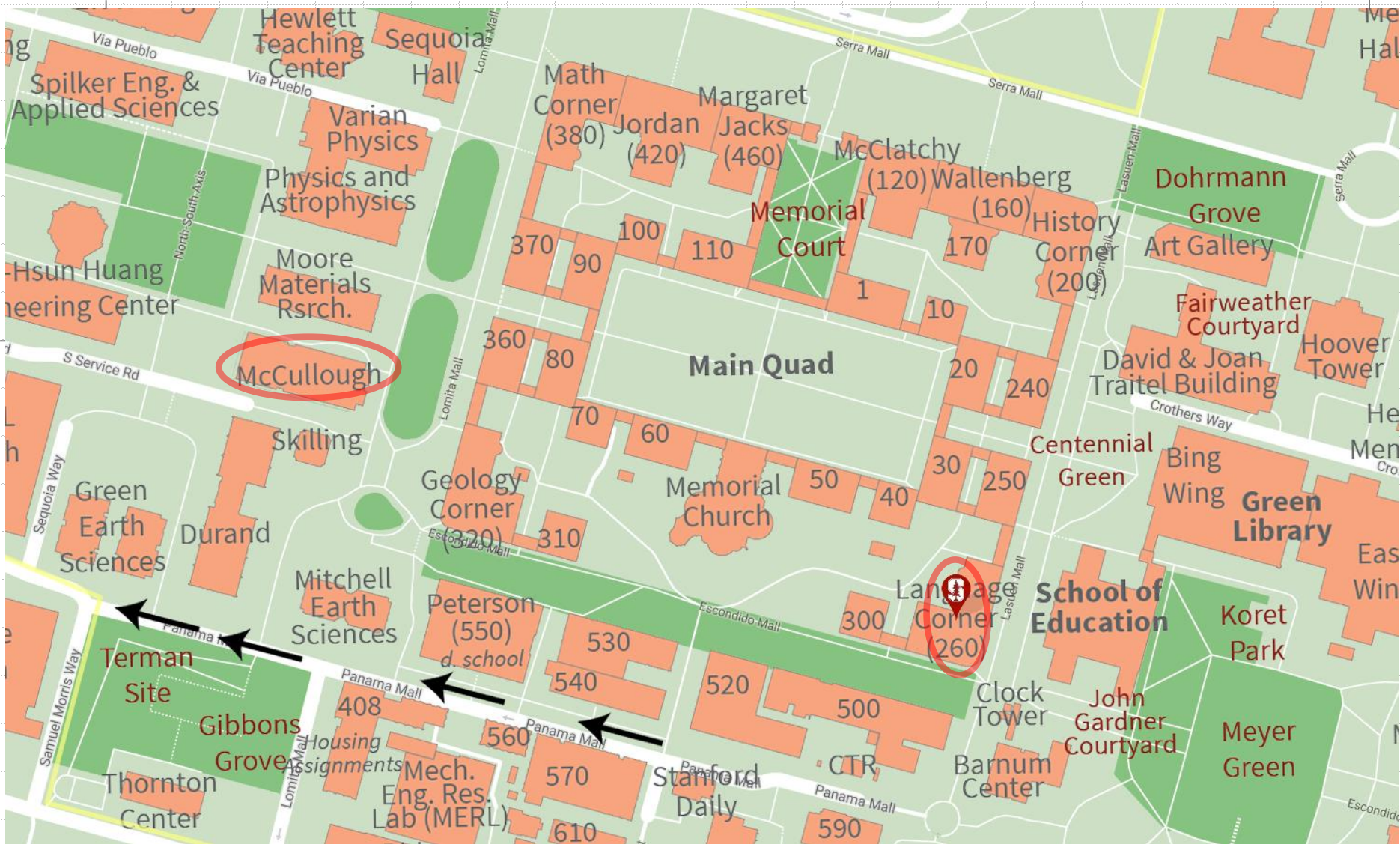

# Properties of X-rays



# Electromagnetic Spectrum

X-rays are electromagnetic radiation of exactly the same nature as light but of very much shorter wavelength

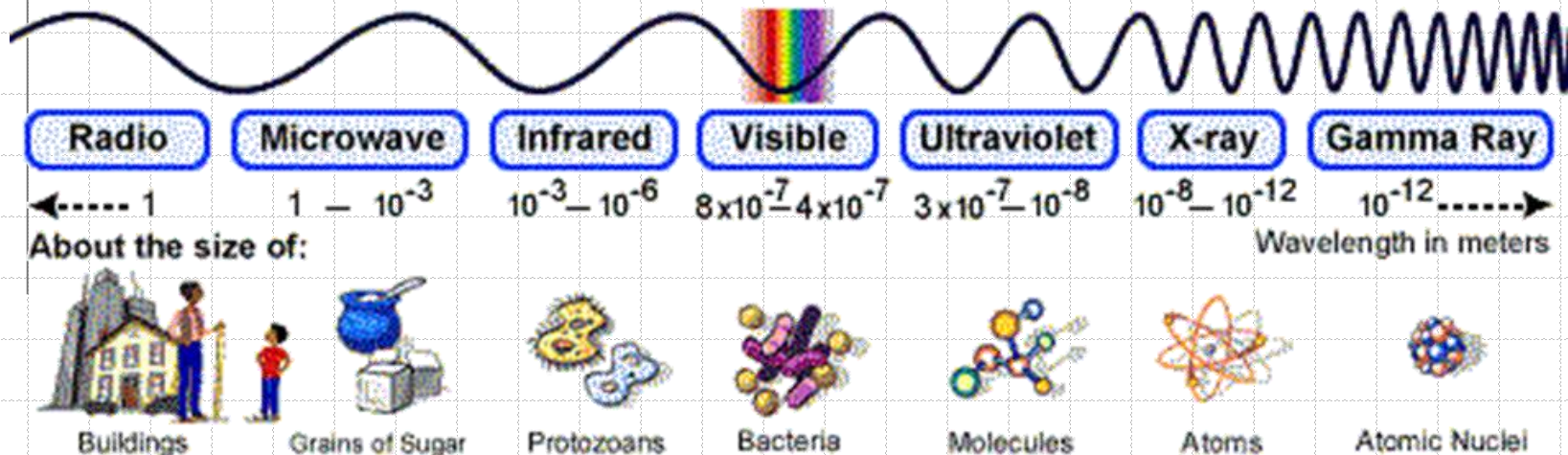

Unit of measurement in x-ray region is  $\text{\AA}$  and nm.

$$1 \text{ \AA} = 10^{-10} \text{ m}, 1 \text{ nm} = 10 \text{ \AA} = 10^{-9} \text{ m}$$

X-ray wavelengths are in the range  $0.5 - 2.5 \text{ \AA}$ .

Wavelength of visible light  $\sim 6000 \text{ \AA}$ .



# Properties of Electromagnetic Waves

- ◆ Electromagnetic radiation can be considered as wave motion in accordance with classical theory.

$$E = A \exp(i\omega t - \varphi)$$

A – amplitude of the wave

$\omega$  – frequency ( $\omega = 2\pi\nu$ )

$\varphi$  – phase ( $\varphi = \nu t$ )

- ◆ According to the quantum theory electromagnetic radiation can also be considered as particles called *photons*. Each photon has associated with it an amount of energy:

$$E = h\nu$$

$$h = 6.63 \times 10^{-34} \text{ Js}$$

Intensity – the rate of flow of electromagnetic radiation energy through unit area perpendicular to the direction of motion of the wave.

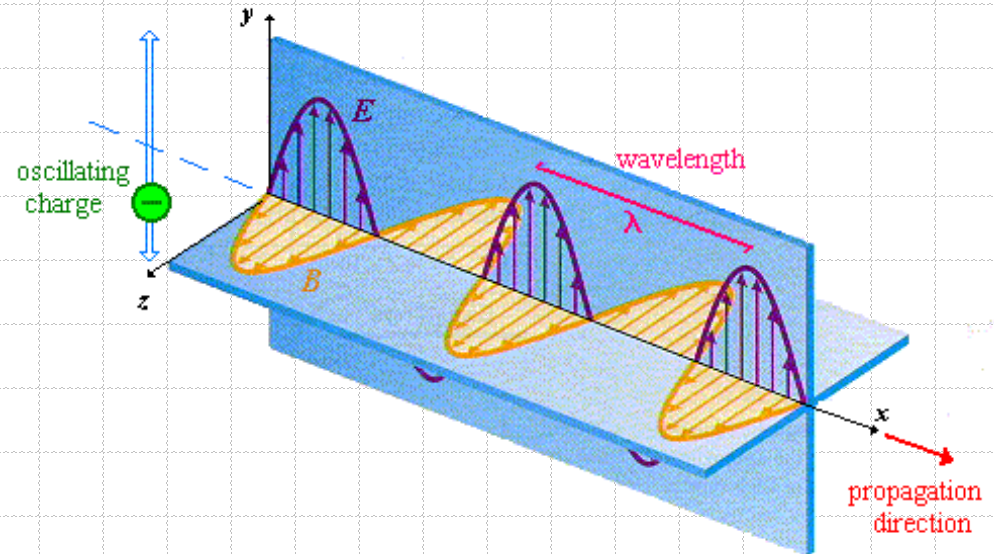

Relationship between wavelength and frequency:

$$\lambda = c/\nu$$

c – velocity of light ( $\sim 3 \times 10^8$  m/s)

# X-ray Spectrum

- ◆ X-rays are produced when accelerated electrons collide with the target.
- ◆ The loss of energy of the electrons due to impact is manifested as x-rays.
- ◆ X-ray radiation is produced in an x-ray tube.
- ◆ Most of the kinetic energy of the electrons striking the target is converted into heat, less than 1% being transformed into x-rays.

$$E_K = eV = \frac{1}{2}mv^2$$

$e$  – electron charge ( $1.6 \times 10^{-19}$  C)  
 $E_K$  – kinetic energy,  $V$  – applied voltage,  
 $m$  – mass of the electron ( $9.11 \times 10^{-31}$  kg),  
 $v$  – electron velocity (m/sec)

**X-ray spectrum of Mo at different voltage**

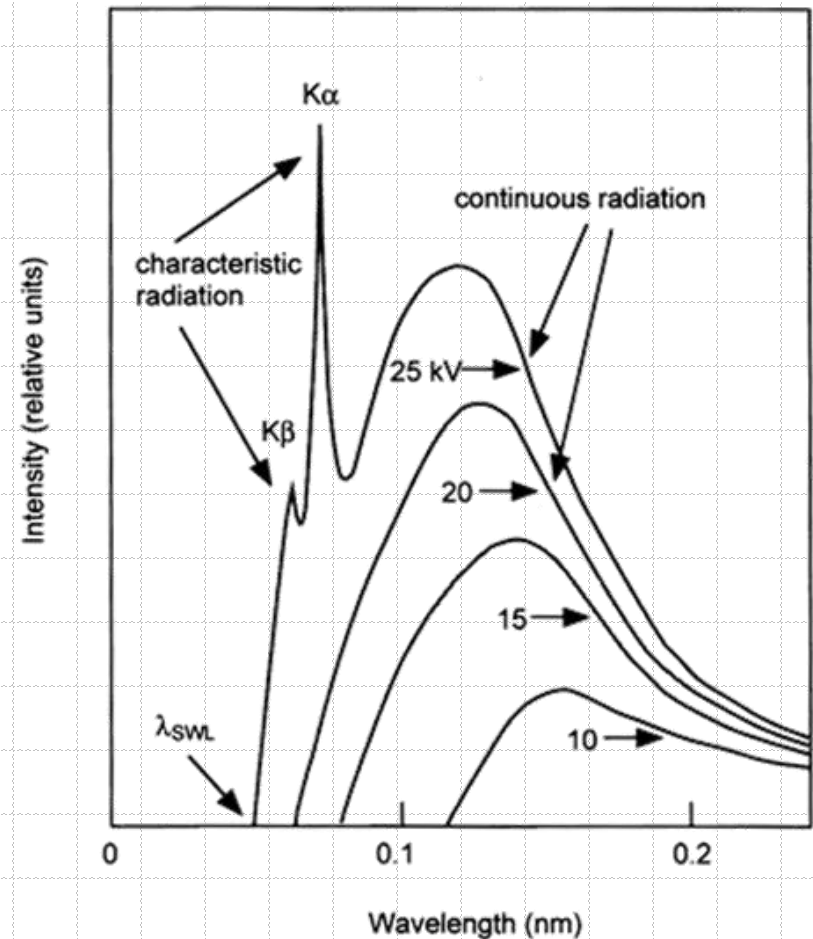

# Continuous X-ray Spectrum

- ◆ Continuous spectrum arises due to the deceleration of the electrons hitting the target.
- ◆ This type of radiation is known as *bremstrahlung*, German for "braking radiation".
- ◆ It is also called *polychromatic*, *continuous* or *white* radiation.
- ◆ Some electrons lose all the energy in a single collision with a target atom.

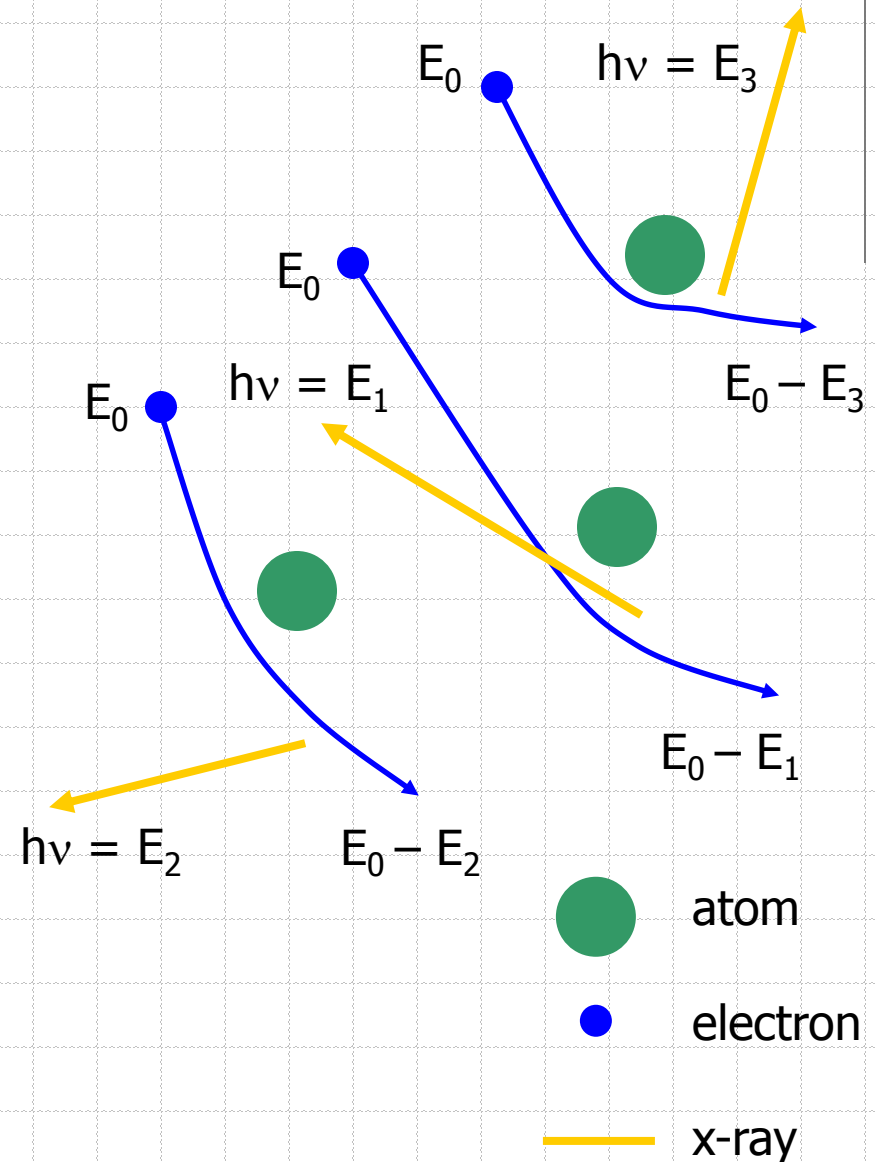

# Properties of the Continuous Spectrum

- ◆ Smooth, monotonic function of intensity vs wavelength.
- ◆ The intensity is zero up to a certain wavelength – *short wavelength limit* ( $\lambda_{SWL}$ ). The electrons transfer all their energy into photon energy:

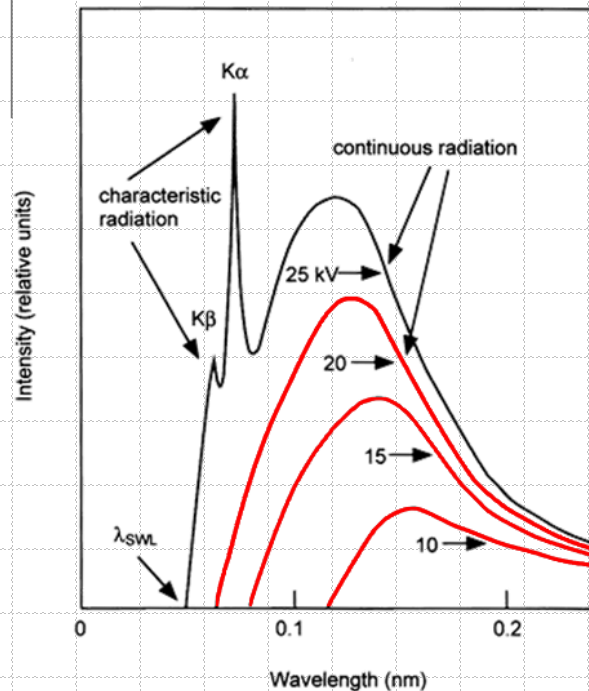

$$eV = h\nu_{\max}$$
$$\lambda_{SWL} = \frac{c}{\nu_{\max}} = \frac{hc}{eV}$$

$$\lambda_{SWL} = \frac{12.398 \times 10^3}{V}$$

$\lambda$  - in Å  
 $V$  - in volts

# Properties of the Continuous Spectrum

- ◆ The total x-ray energy emitted per second depends on the atomic number  $Z$  of the target material and on the x-ray tube current. This total x-ray intensity is given by

$$I_{cont.} = AiZV^m$$

$A$  – proportionality constant

$i$  – tube current (measure of the number of electrons per second striking the target)

$m$  – constant  $\approx 2$



# The Characteristic Spectrum

Discovered by W.H. Bragg and systematized by H.G. Moseley.

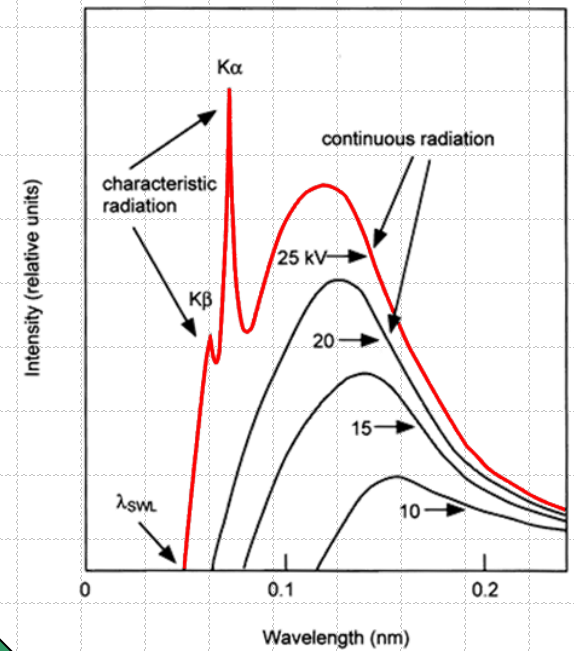
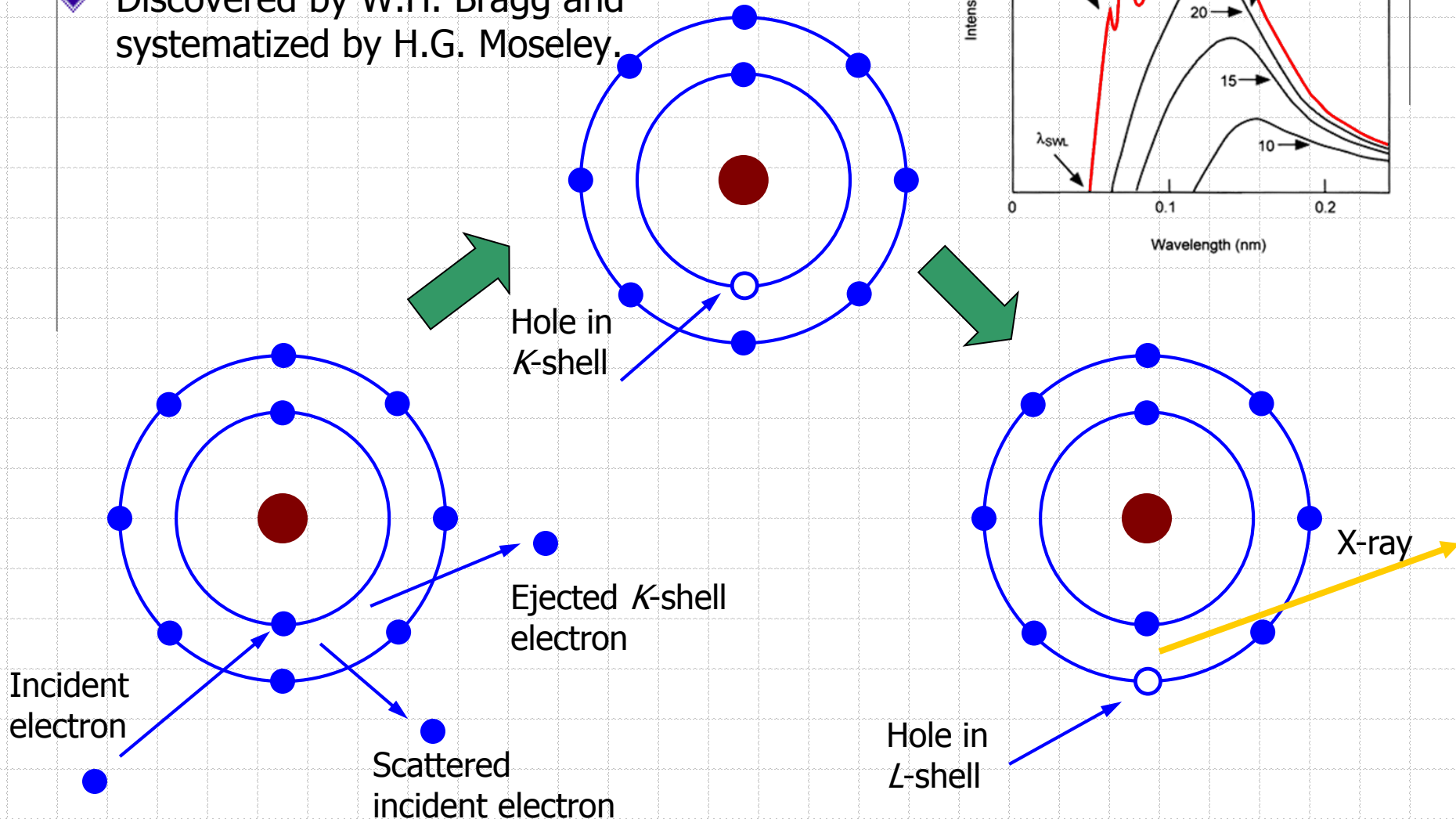

# The Characteristic Spectrum

- ◆ The characteristic peak is created in when a hole in the inner shell, created by a collision event, is filled by an electron from higher energy shell.
- ◆ Let a  $K$ -shell electron be knocked out -- the vacancy can be filled by an electron from the  $L$ -shell ( $K\alpha$  radiation) or the  $M$ -shell ( $K\beta$  radiation).

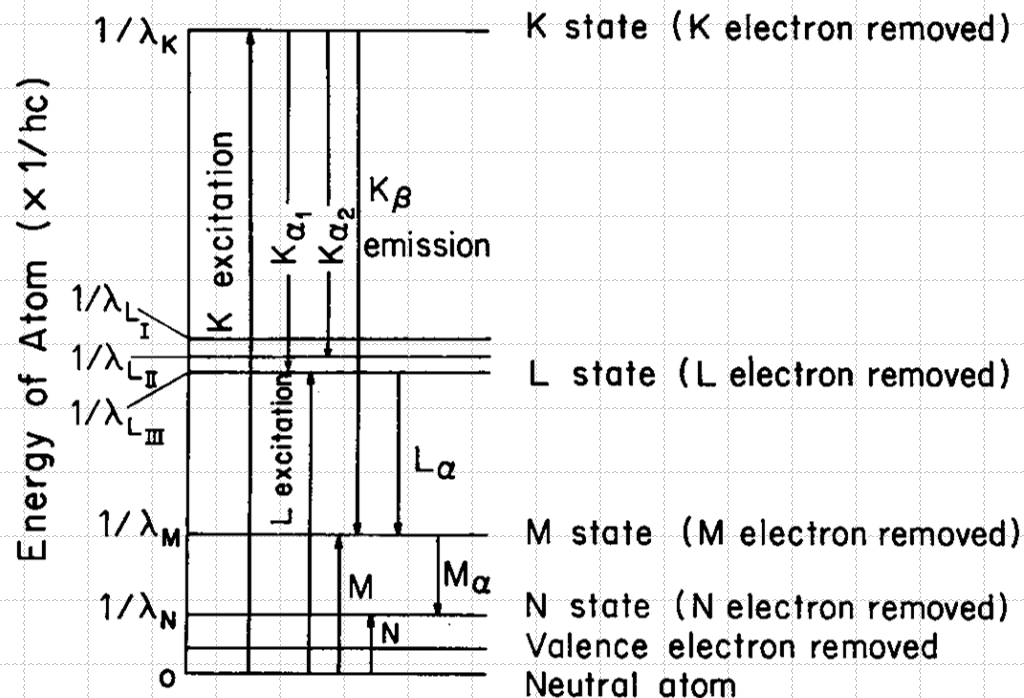

# Properties of the Characteristic Spectrum

- ◆ Usually only the  $K$ -lines are useful in x-ray diffraction.
- ◆ There are several lines in the  $K$ -set. The strongest are  $K\alpha_1$ ,  $K\alpha_2$ ,  $K\beta_1$ .
- ◆  $\alpha_1$  and  $\alpha_2$  components are not always resolved –  $K\alpha$  doublet.  $K\alpha_1$  is always about twice as strong as  $K\alpha_2$ , while ratio of  $K\alpha_1$  to  $K\beta_1$  averages about 5/1.

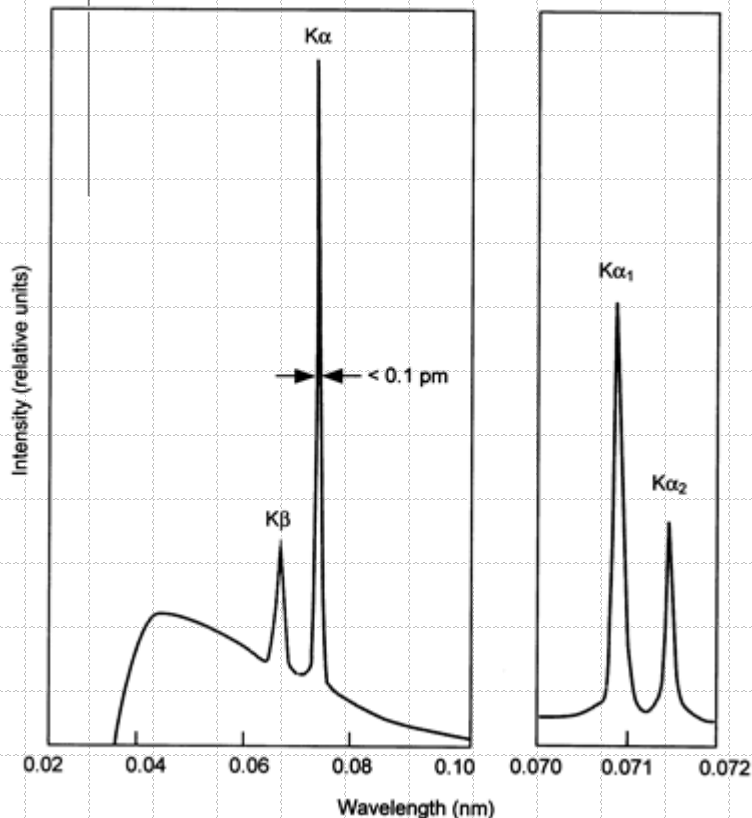

**Some Commonly Used X-ray  $K$  wavelengths (Å)**

Element	$K\alpha$ (av.)	$K\alpha_1$	$K\alpha_2$	$K\beta_1$
Cr	2.29100	2.28970	2.29361	2.08487
Fe	1.93736	1.93604	1.93998	1.75661
Co	1.79026	1.78897	1.79285	1.62079
Cu	1.54184	1.54056	1.54439	1.39222
Mo	0.71073	0.70930	0.71359	0.63229

# Properties of the Characteristic Spectrum

- ◆ The intensity of any characteristic line depends both on the tube current  $i$  and the amount by which the applied voltage  $V$  exceeds the critical excitation voltage for that line. For a  $K$ -line:

$$I_{K\text{-line}} = Bi(V - V_K)^n$$

$B$  – proportionality constant

$V_K$  – the  $K$  excitation voltage

$n \approx 1.5$

- ◆ Characteristic lines are also very narrow, most of them less than 0.001 Å wide (Full Width At Half Maximum).
- ◆ High intensity and narrow  $K$ -lines makes x-ray diffraction possible, since it generally requires the use of monochromatic radiation.

# Moseley's Law

- ◆ The wavelength of any particular line decreases as the atomic number of the emitter is increased.
- ◆ There is a linear relation between the square root of the line frequency  $\nu$  and the atomic number  $Z$ :

$$\sqrt{\nu} = C(Z - \sigma)$$

$C$  and  $\sigma$  – constants.

For Cu:  $\lambda = 1.5406 \text{ \AA}$

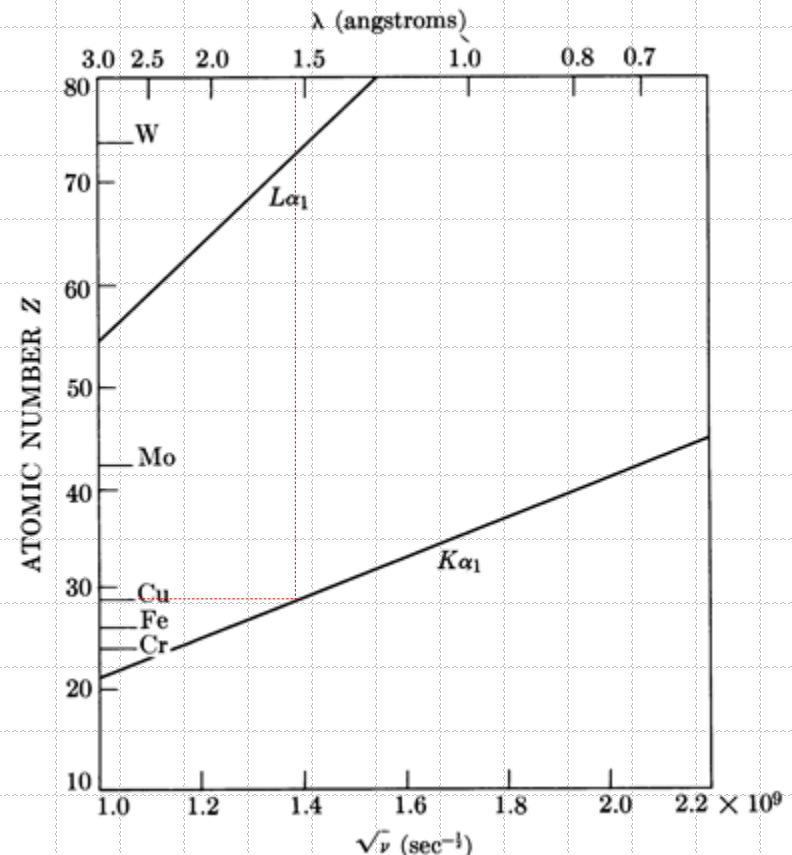



# X-ray Absorption

- ◆ When x-rays encounter any form of matter, they are partly transmitted and partly absorbed.
- ◆ It was found experimentally that

$$I \propto x$$

$I$  – intensity

$x$  – distance

- ◆ In differential form

$$-\frac{dI}{I} = \mu dx$$

where  $\mu$  - is *linear absorption coefficient*

# X-ray Absorption

- ◆ After integration

$$I_x = I_0 e^{-\mu x}$$

$I_0$  – incident beam intensity

$I_x$  – transmitted beam intensity

- ◆ Let's introduce *mass absorption coefficient* -  $\mu/\rho$  ( $\rho$  - density). It is constant and independent of physical state (solid, liquid, or gas). Then

$$I_x = I_0 e^{-(\mu/\rho)\rho x}$$

- ◆ Values of the mass absorption coefficient  $\mu/\rho$  are tabulated.

# Mass Absorption Coefficient

- ◆ The mass absorption coefficient of the substance containing more than one element is a weighted average of the mass absorption coefficients of its constituent elements.
- ◆ If  $w_1, w_2, w_3, \dots$  are the weight fractions of elements 1, 2, 3, ... and  $(\mu/\rho)_1, (\mu/\rho)_2, (\mu/\rho)_3, \dots$  their mass absorption coefficients then

$$\frac{\mu}{\rho} = w_1 \left( \frac{\mu}{\rho} \right)_1 + w_2 \left( \frac{\mu}{\rho} \right)_2 + w_3 \left( \frac{\mu}{\rho} \right)_3 + \dots$$

# Properties of the Absorption Coefficient

- ◆ There is a sharp discontinuity in the dependence of the absorption coefficient on energy (wavelength) at the energy corresponding to the energy required to eject an inner-shell electron.
- ◆ The discontinuity is known as an absorption edge.
- ◆ Away from an absorption edge, each “branch” of the absorption curve is given by:

$$\frac{\mu}{\rho} = k\lambda^3 Z^3$$

$k$  – a constant

$Z$  – atomic number of absorber

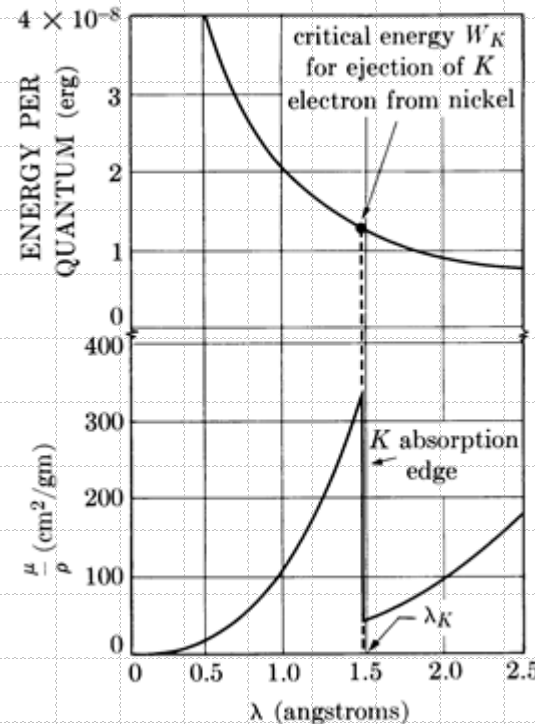

$$I_x = I_0 e^{-(\mu/\rho)\rho x}$$

# Properties of the Absorption Coefficient

- Incident x-ray quanta with energy  $W_K$  can knock out an electron from K atomic shell.

$$eV_K = W_K = h\nu_K = \frac{hc}{\lambda_K}$$

- $\nu_K$  – frequency of the  $K$  absorption edge
- $\lambda_K$  – wavelength of the  $K$  absorption edge
- $V_K$  –  $K$  excitation voltage

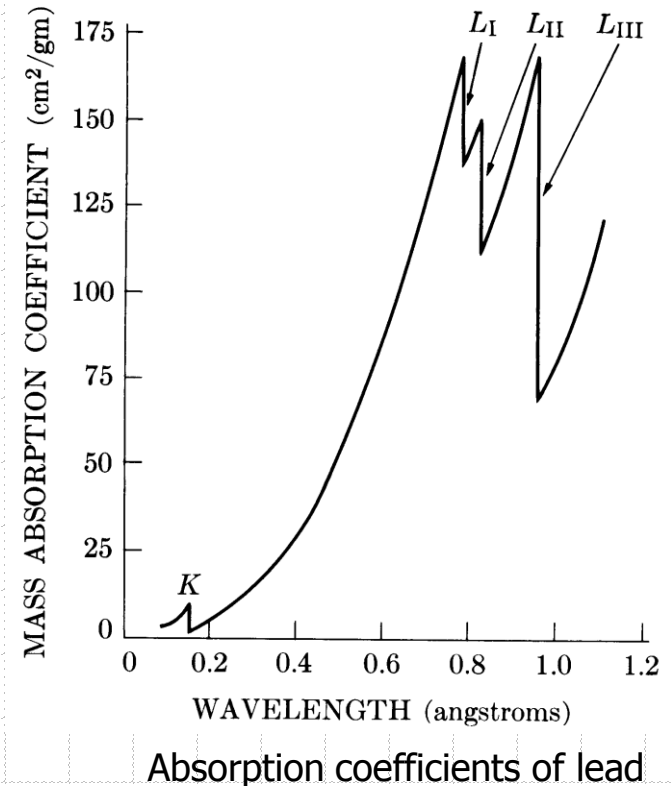
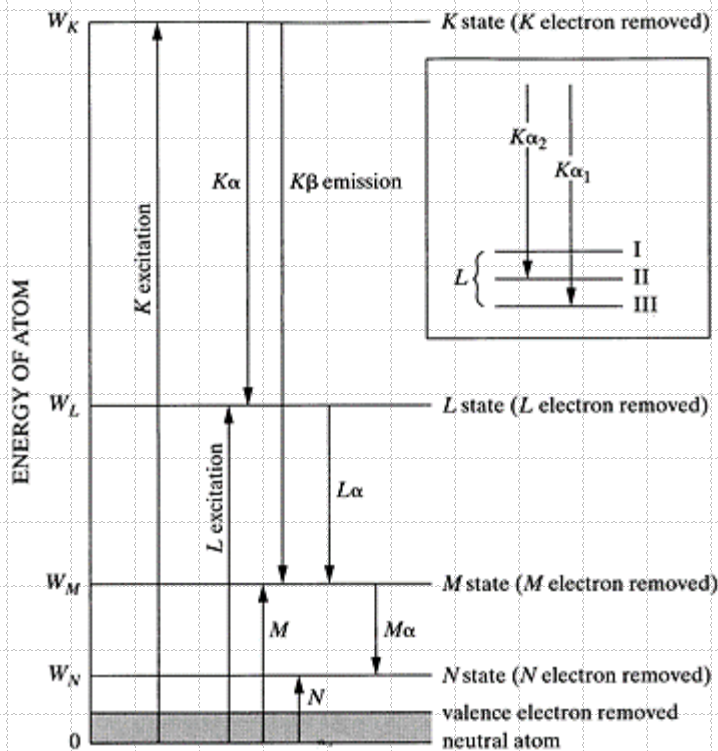



# X-ray Filters

- Usually x-ray diffraction experiments require monochromatic radiation.
- Undesirable wavelength can be suppressed by passing the beam through an absorber (*filter*) which absorption edge lies just above the parasitic wavelength.

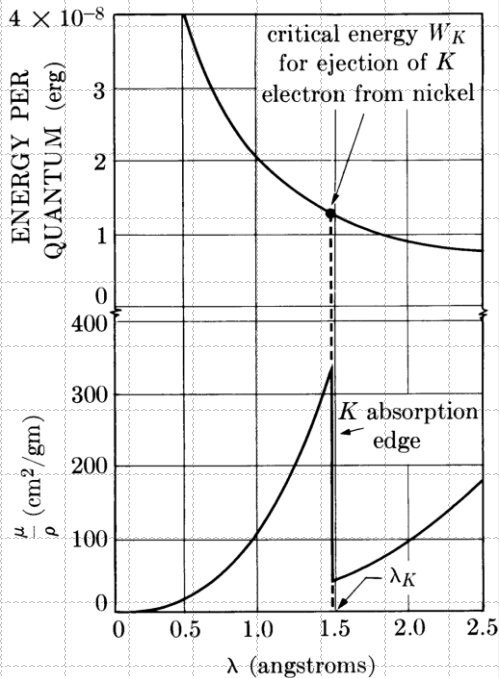

## Cu radiation

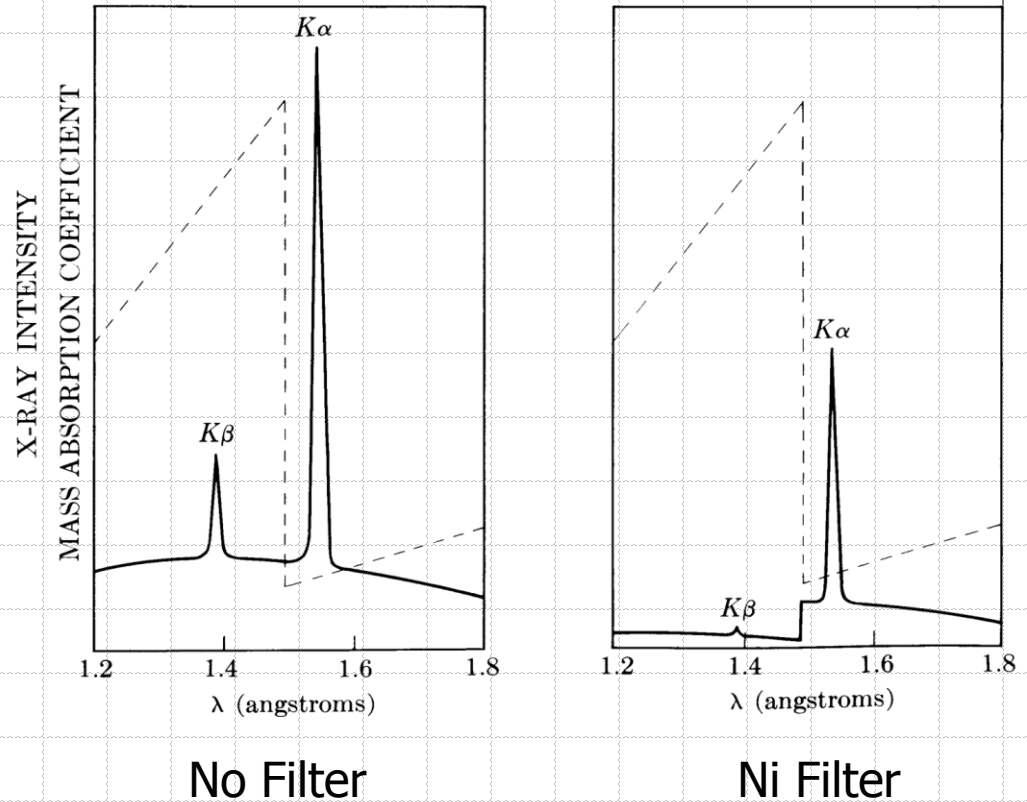

# X-ray Filters

- ◆ The filtration is never perfect. Thicker the filter better the suppression of  $K\beta$  component but this also results in weaker  $K\alpha$ . There is always a compromise.

19 <b>K</b> potassium 39.098	20 <b>Ca</b> calcium 40.078(4)	21 <b>Sc</b> scandium 44.956	22 <b>Ti</b> titanium 47.867	23 <b>V</b> vanadium 50.942	24 <b>Cr</b> chromium 51.996	25 <b>Mn</b> manganese 54.938	26 <b>Fe</b> iron 55.845(2)	27 <b>Co</b> cobalt 58.933	28 <b>Ni</b> nickel 58.693	29 <b>Cu</b> copper 63.546(3)	30 <b>Zn</b> zinc 65.38(2)	31 <b>Ga</b> gallium 69.723	32 <b>Ge</b> germanium 72.630(8)
37 <b>Rb</b> rubidium 85.468	38 <b>Sr</b> strontium 87.62	39 <b>Y</b> yttrium 88.906	40 <b>Zr</b> zirconium 91.224(2)	41 <b>Nb</b> niobium 92.906	42 <b>Mo</b> molybdenum 95.95	43 <b>Tc</b> technetium	44 <b>Ru</b> ruthenium 101.07(2)	45 <b>Rh</b> rhodium 102.91	46 <b>Pd</b> palladium 106.42	47 <b>Ag</b> silver 107.87	48 <b>Cd</b> cadmium 112.41	49 <b>In</b> indium 114.82	50 <b>Sn</b> tin 118.71

## Filters for Suppression of $K\beta$ Radiation

Target	Filter	Incident beam* $\frac{I(K\alpha)}{I(K\beta)}$	Filter thickness for $\frac{I(K\alpha)}{I(K\beta)} = \frac{500}{1}$ in trans. beam		$\frac{I(K\alpha) \text{ trans.}}{I(K\alpha) \text{ incident}}$
			mg/cm <sup>2</sup>	in.	
Mo	Zr	5.4	77	0.0046	0.29
Cu	Ni	7.5	18	0.0008	0.42
Co	Fe	9.4	14	0.0007	0.46
Fe	Mn	9.0	12	0.0007	0.48
Cr	V	8.5	10	0.0006	0.49

# X-ray Sources

◆ The tube must have:

- source of electrons
- high accelerating voltage
- metal target

◆ X-ray tube types:

- Gas tube – the original x-ray tube ⇒ **obsolete**.
- Filament tube – most common type of laboratory x-ray source.

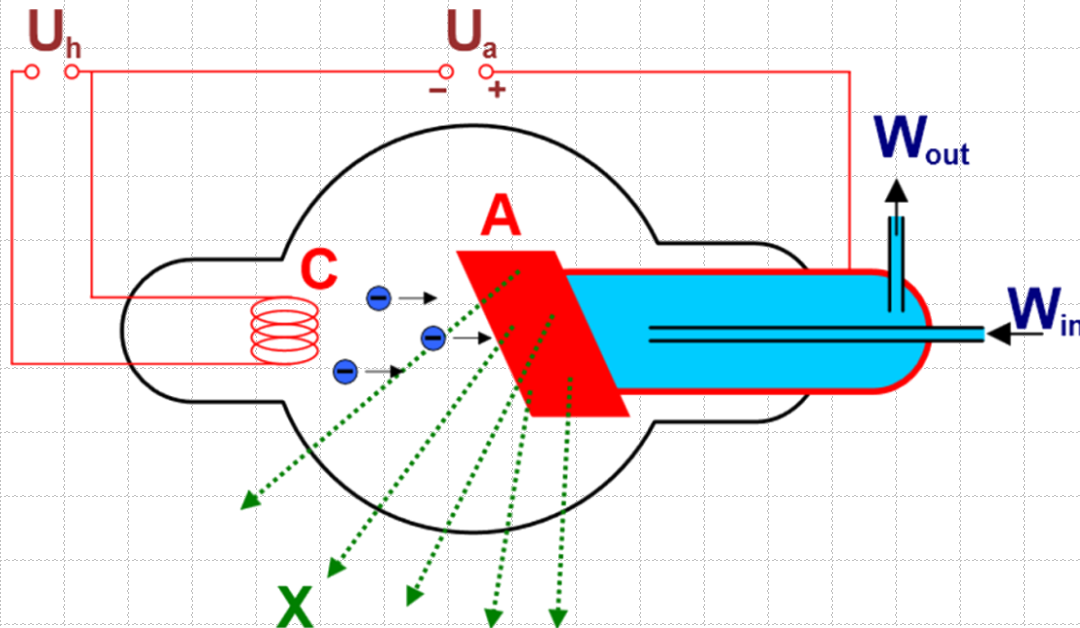
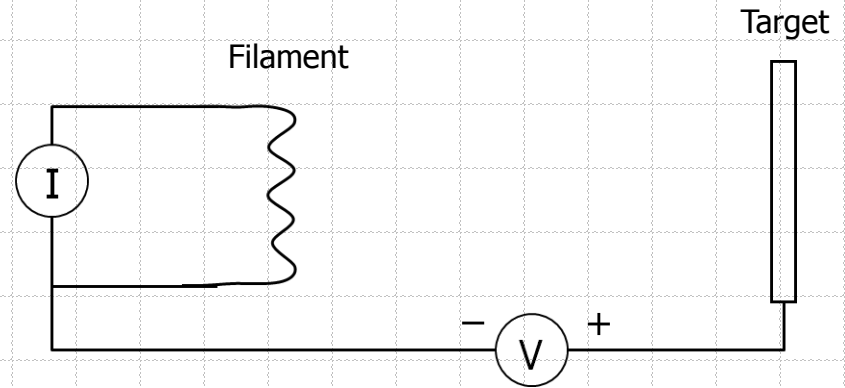

# Filament X-ray Tube

- ◆ Invented by Coolidge in 1913.
- ◆ The most widely-used laboratory X-ray source.
- ◆ Major components are a water-cooled target (anode) and a tungsten filament (cathode) that emits electrons.
- ◆ A high potential (up to 60 kV) is maintained between the filament and the anode, accelerating the electrons into the the anode and generating X-rays.
- ◆ Cooling water is circulated through the anode to keep it from melting (>99% of input power generates heat).
- ◆ Interior of the tube is evacuated for the electron beam; thin beryllium windows transmit the X-rays.

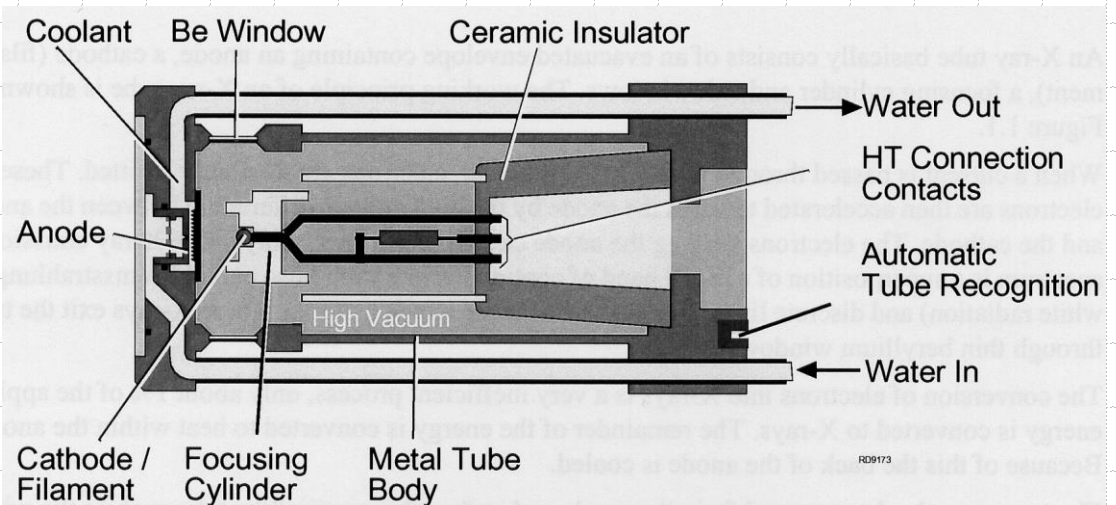

Ceramic Diffraction X-ray Tube –  
Schematic View

# Filament X-ray Tube

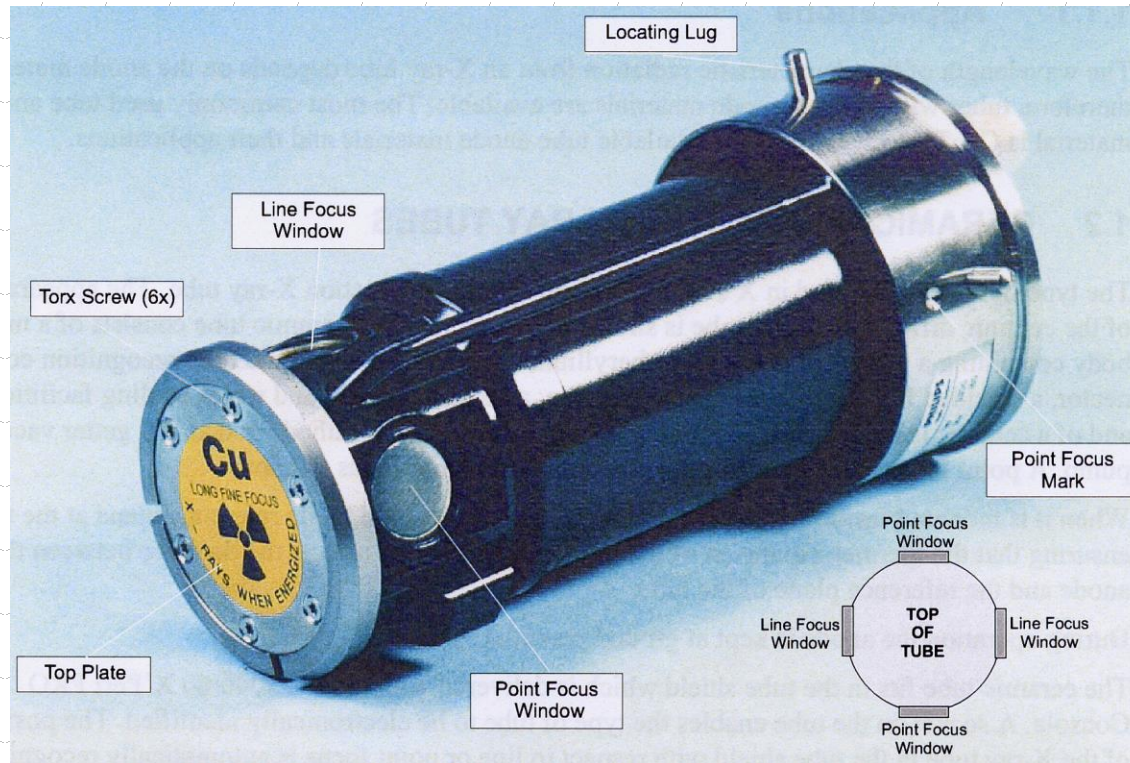

Ceramic Diffraction X-ray Tube – Physical View



# Aspects of X-ray tube design and operation

- ◆ The electron beam produced and controlled by the current that is passed through the filament.
- ◆ Stable high voltage and filament current power supplies are needed (old-style transformers → high frequency supplies).
- ◆ Power rating: applied potential × electron beam current (example: 50 kV and 40 mA → 2 kW).
- ◆ Maximum power determined by the rate of heat removal (without water, a tube can be destroyed in **seconds** → flow interlocks).
- ◆ The anode is electrically grounded, while the filament is kept at negative kV's (the water-cooled anode won't short out, and the filament is protected by glass insulation).
- ◆ Beryllium windows are fragile and toxic:
  - don't shock (mechanically or thermally).
  - don't touch (and don't taste!).

# Selecting X-ray tube for Application

- ◆ The shape of the incident beam depends on the focal projection of the filament onto and from the anode material.
- ◆ X-ray beams that are parallel with wide projection of the filament have a focal shape of a *line*.
- ◆ X-ray beams that are parallel with the narrow projection of the filament have an approximate focal shape of a square, which is usually labeled as a *spot*.
- ◆ These two focal projections are  $90^\circ$  apart in the plane normal to the filament-anode axis.
- ◆ As the angle from the anode surface is increased, the intensity of the beam increases, but the spot also becomes less focused.

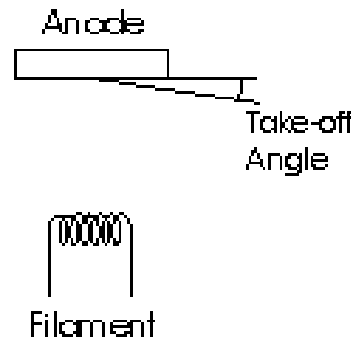
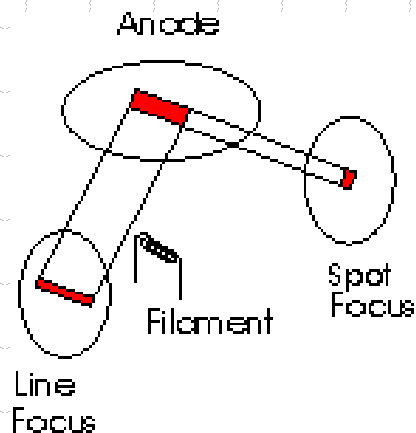

Take-off angles are typically in the  $3 - 6^\circ$  range.

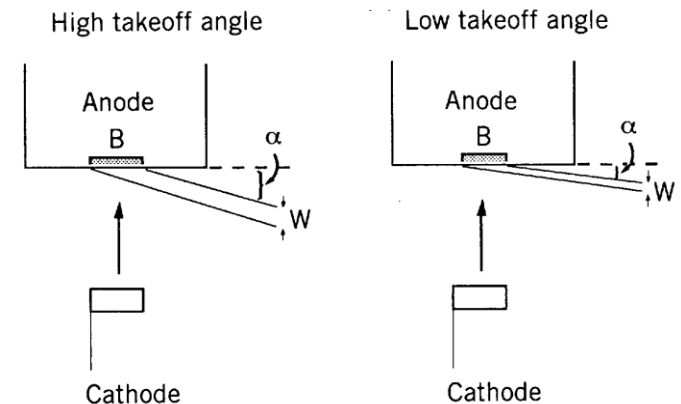

# Selection of XRD Tubes According to Anode Material

<b>Anode Material</b>	<b>Atomic Number</b>	<b>Application</b>
Copper (Cu)	29	Suitable for most diffraction examinations - most widely used anode material.
Moly (Mo)	42	Preferably used for examinations on steels and metal alloys with elements in the range Titanium (Ti) (atomic No. = 22) to approx. Zinc (Zn) (atomic No. = 30)
Cobalt (Co)	27	Often used with ferrous samples, the Iron (Fe) fluorescence radiation would cause interference and cannot be eliminated by other measures.
Iron (Fe)	26	Examination of ferrous samples. Also for use with minerals where Co and Cr tubes cannot be used.
Chromium (Cr)	24	Used for complex organic substances and also radiographic stress measurements on steels.
Tungsten (W)	74	Used where an intensive white spectrum is of more interest than the characteristic.

# Rotating Anode X-ray Generator

- ◆ The maximum power of an X-ray generator can be greatly increased if a new cooled surface is continually presented to the electron beam
- ◆ Typical rotating anode generators operate from 12 kW to 18 kW (60 kV/300 mA); specialized generators will go up to 90 kW (60 kV/1500 mA)



Rigaku rotating anode

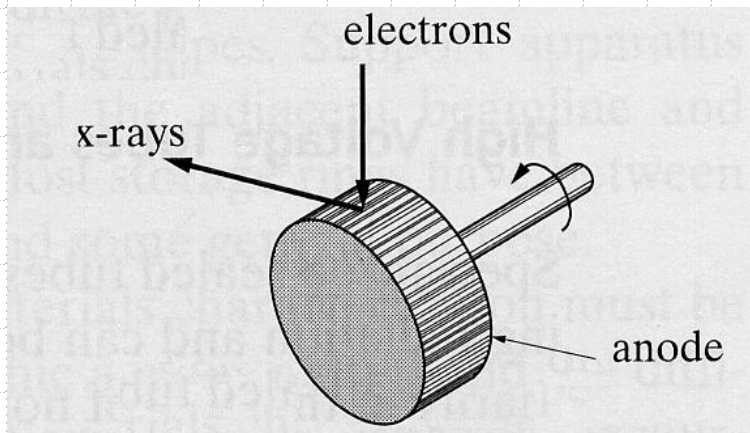

# Rotating Anode X-ray Generator

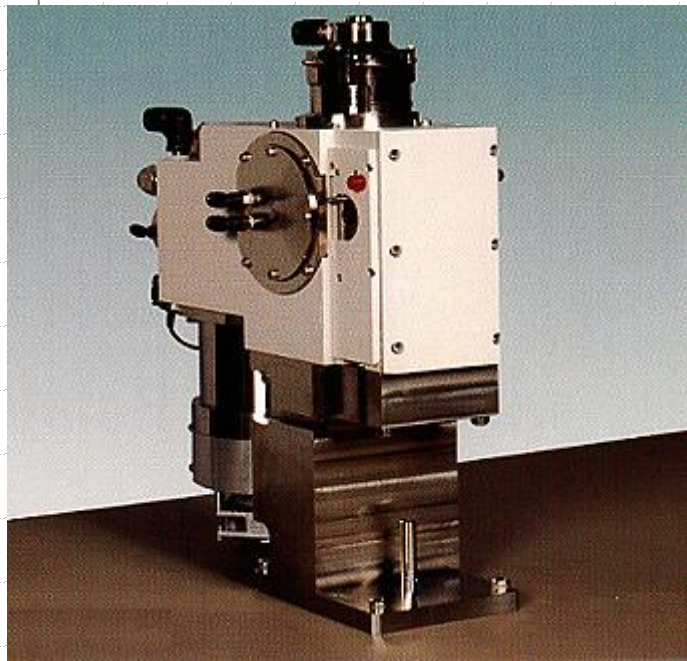
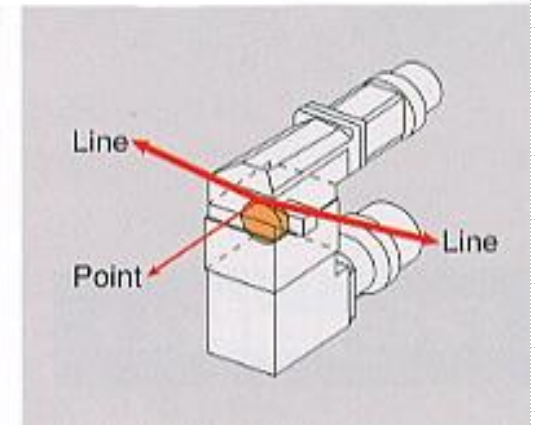
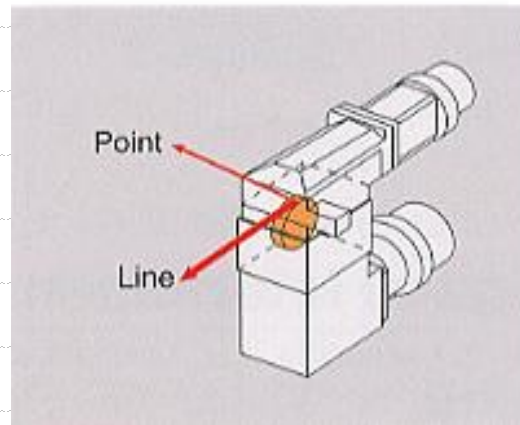
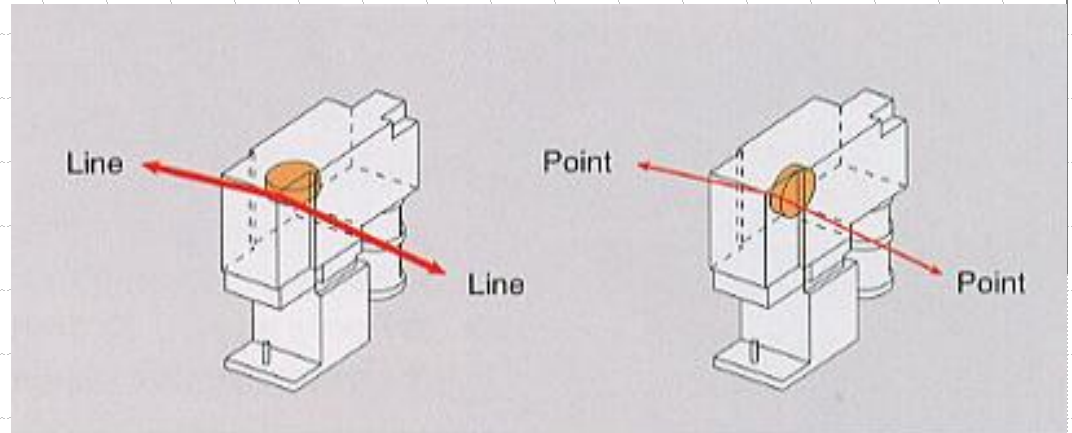

Rotating anode tube housing

Tube housing designs

# Aspects of Rotating Anode X-ray Generators

- ◆ The anode (about 100 mm diameter × 40 mm wide) rotates at speeds of 2400 rpm up to 6000 rpm.
- ◆ Exceptional dynamic balancing is required.
- ◆ Rotating anode resides in a high vacuum environment (better than  $10^{-6}$  Torr) with both rotation and water feedthroughs.
- ◆ Impressive water flow rates are necessary.
- ◆ Electron beam currents exceeding 0.3 A at 60 kV.
- ◆ **Rotating anode generators are expensive and require high maintenance but are the most powerful laboratory X-ray source available – higher X-ray fluxes require a synchrotron.**

# Microfocus x-ray source

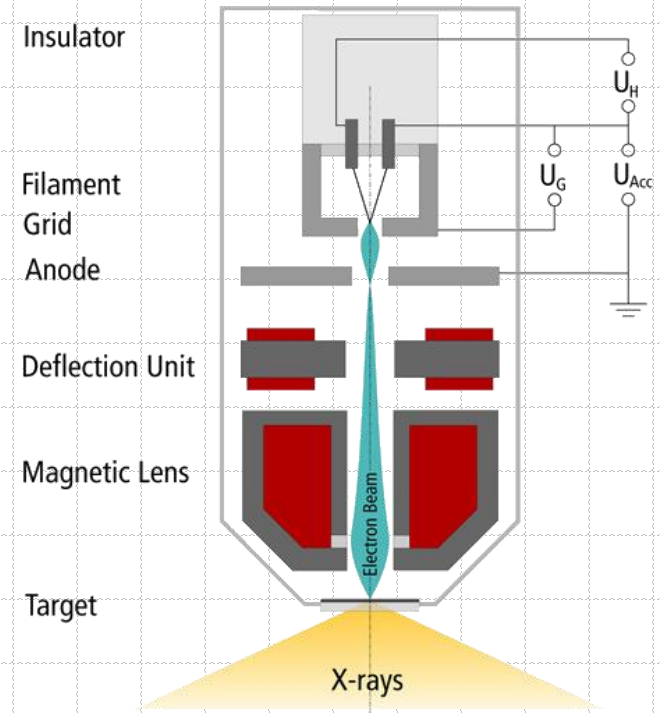



# Synchrotron Radiation Sources

◆ **Synchrotron radiation** is generated when the charged particles are accelerated perpendicular to their trajectory. This is usually achieved by magnetic fields, e.g. bending magnets or periodical magnetic devices (so-called insertion devices). Due to the relativistic energy of the particles the generated light has superior properties:

- The emitted **continuous spectrum** is of **high intensity**.
- The natural **divergence** of the radiation is very small and collimators further reduce these values.
- Distinct linear or circular **polarization**, which can be selected depending on the application.

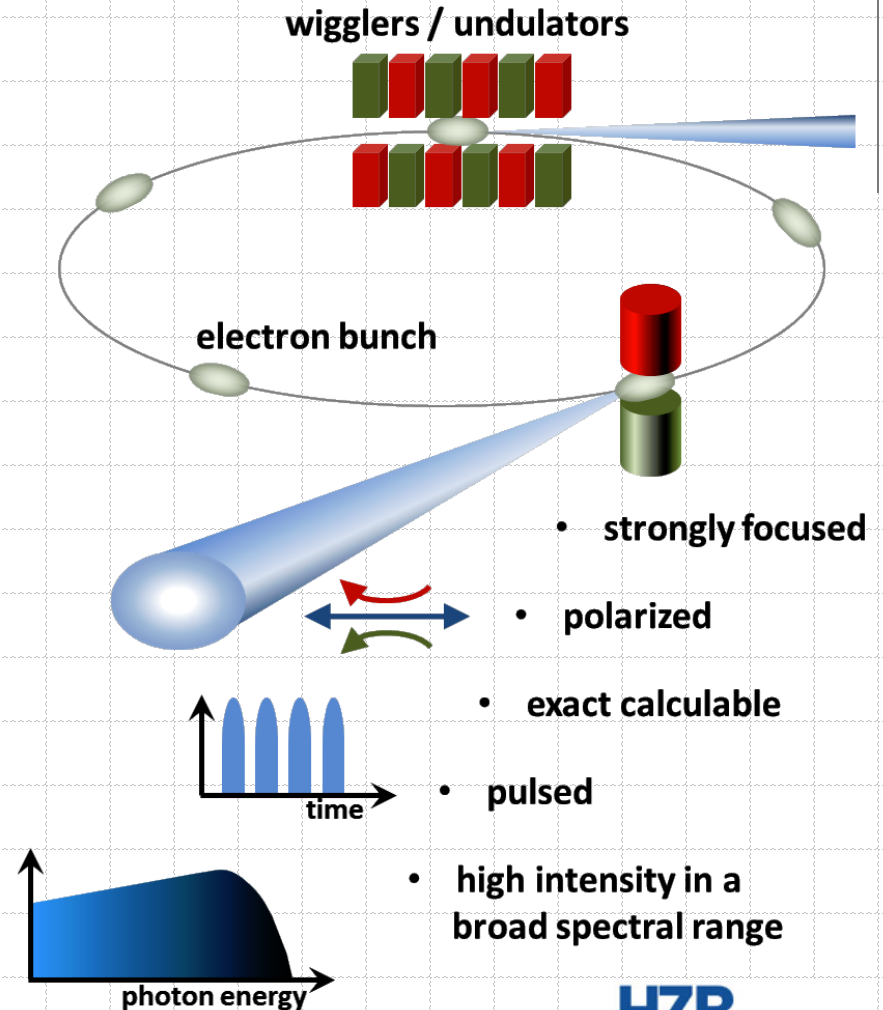



# Synchrotron Radiation Sources

## Stanford Synchrotron Radiation Laboratory

*A national user facility for academia, industry, and national laboratories*

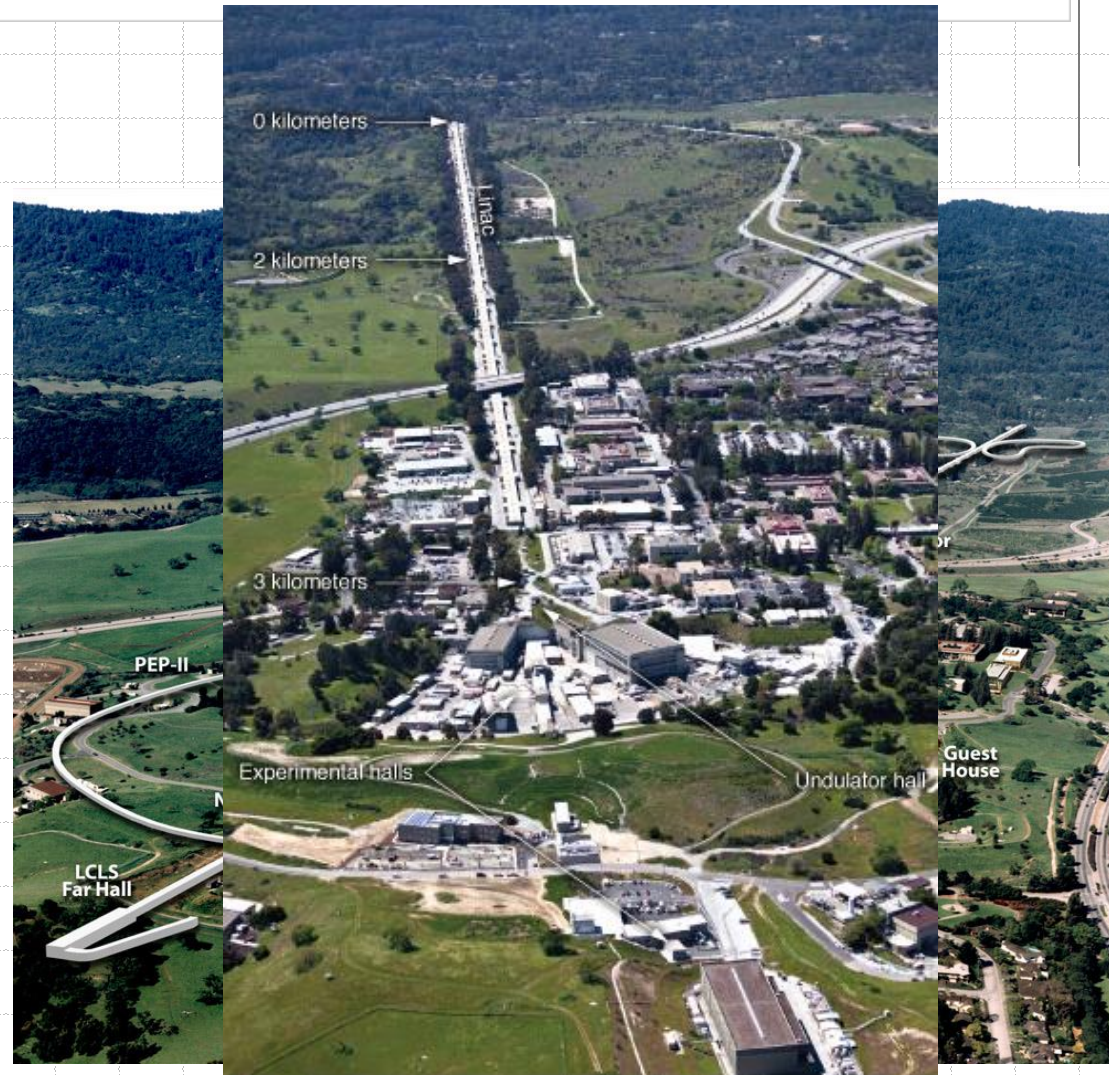



Advanced Photon Source

Apple's new campus

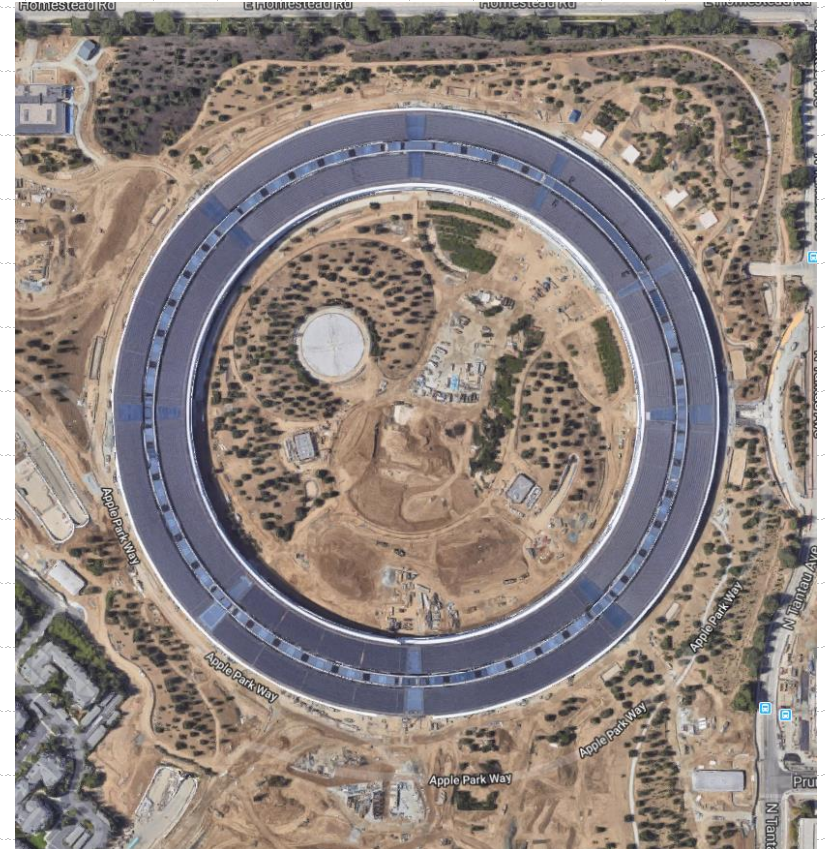
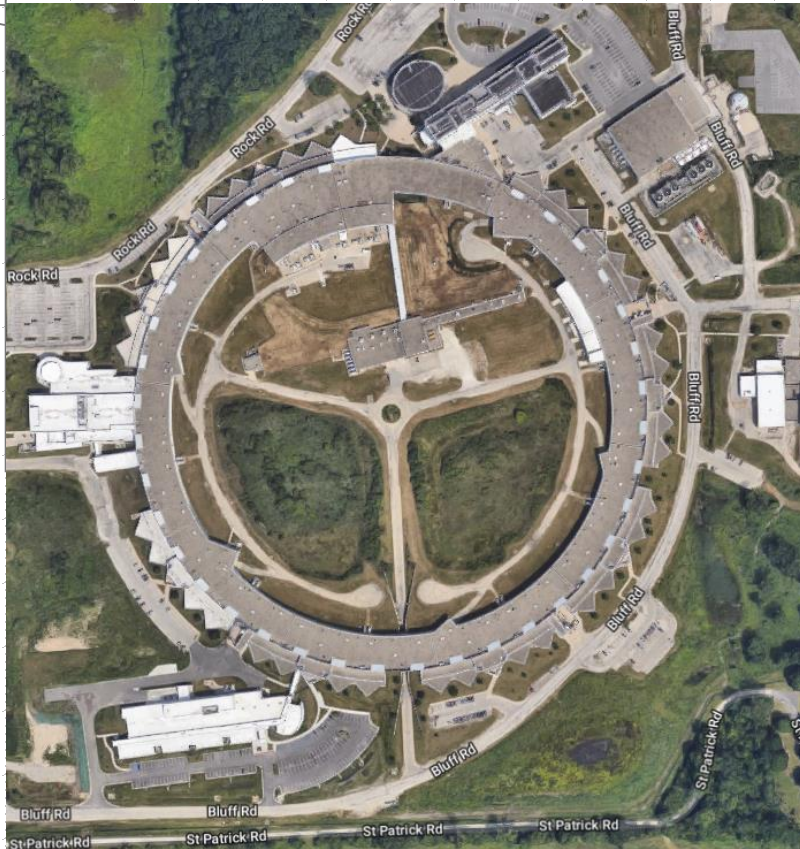

100 ft

# Synchrotron Radiation Sources

SSRL Beam Line Map

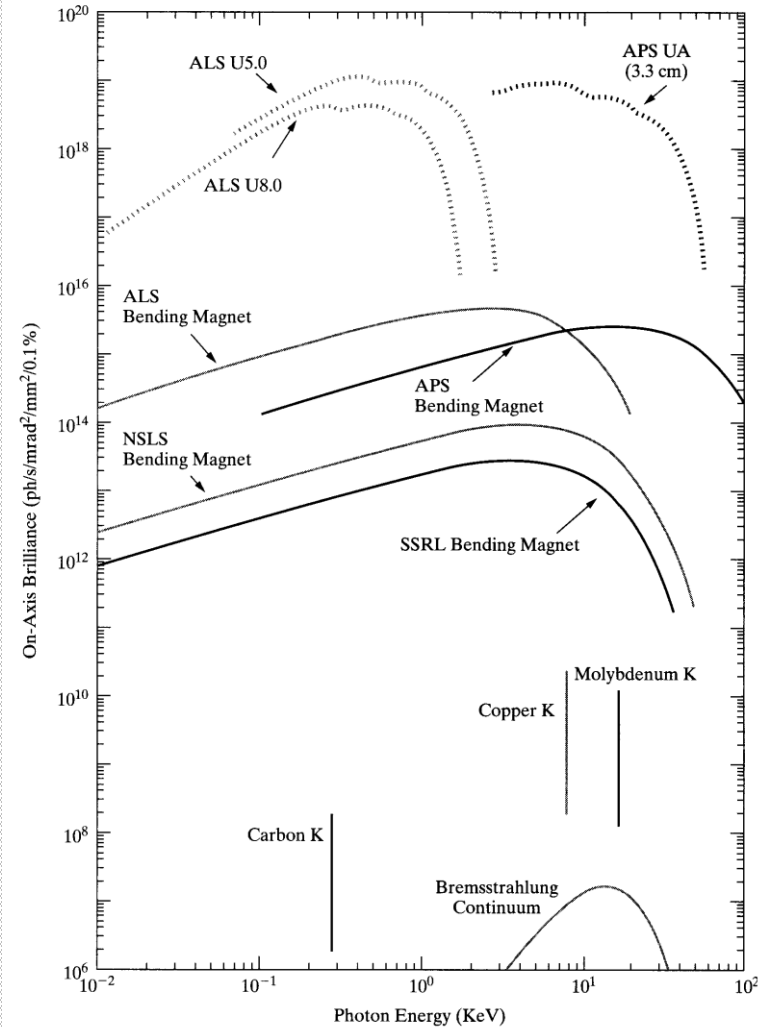
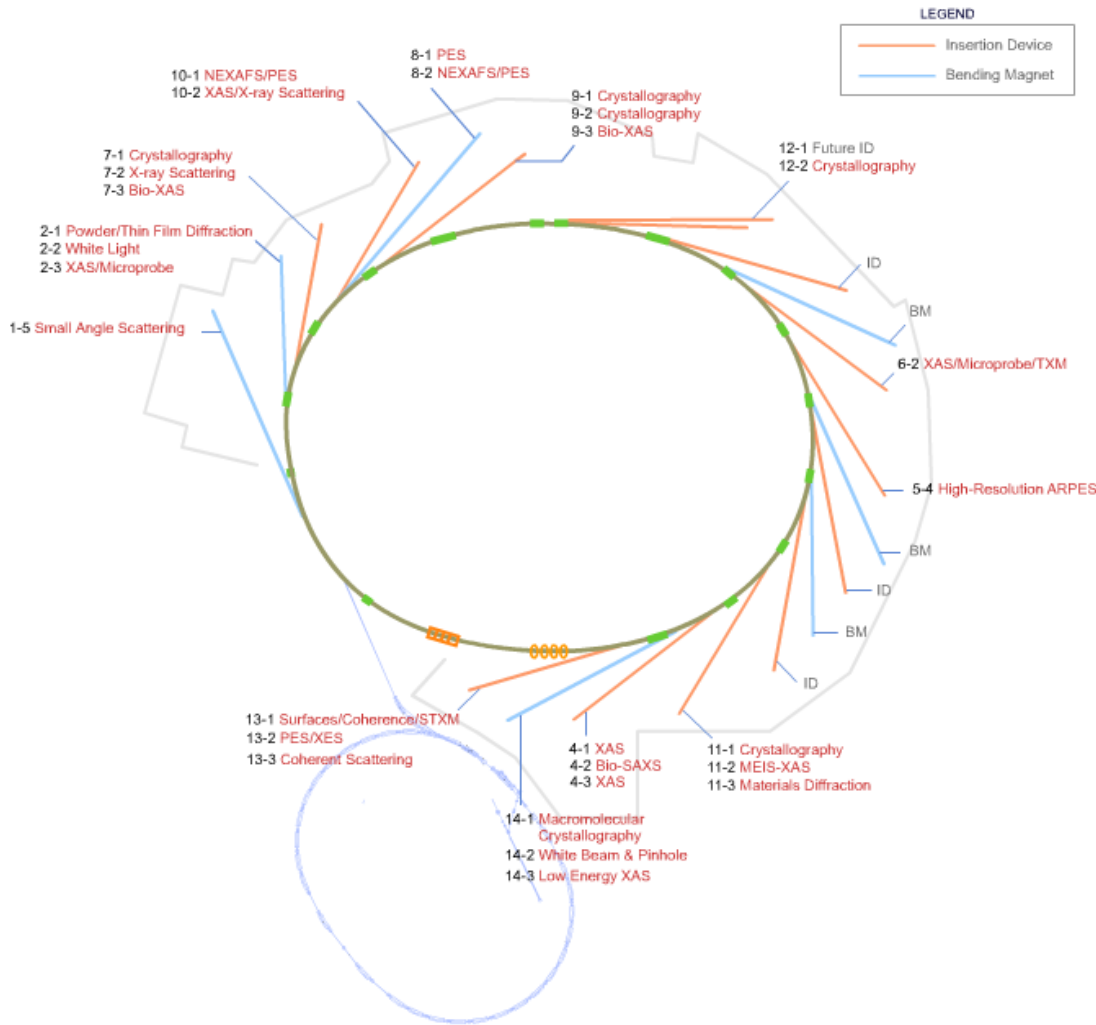

# Synchrotron Radiation Sources

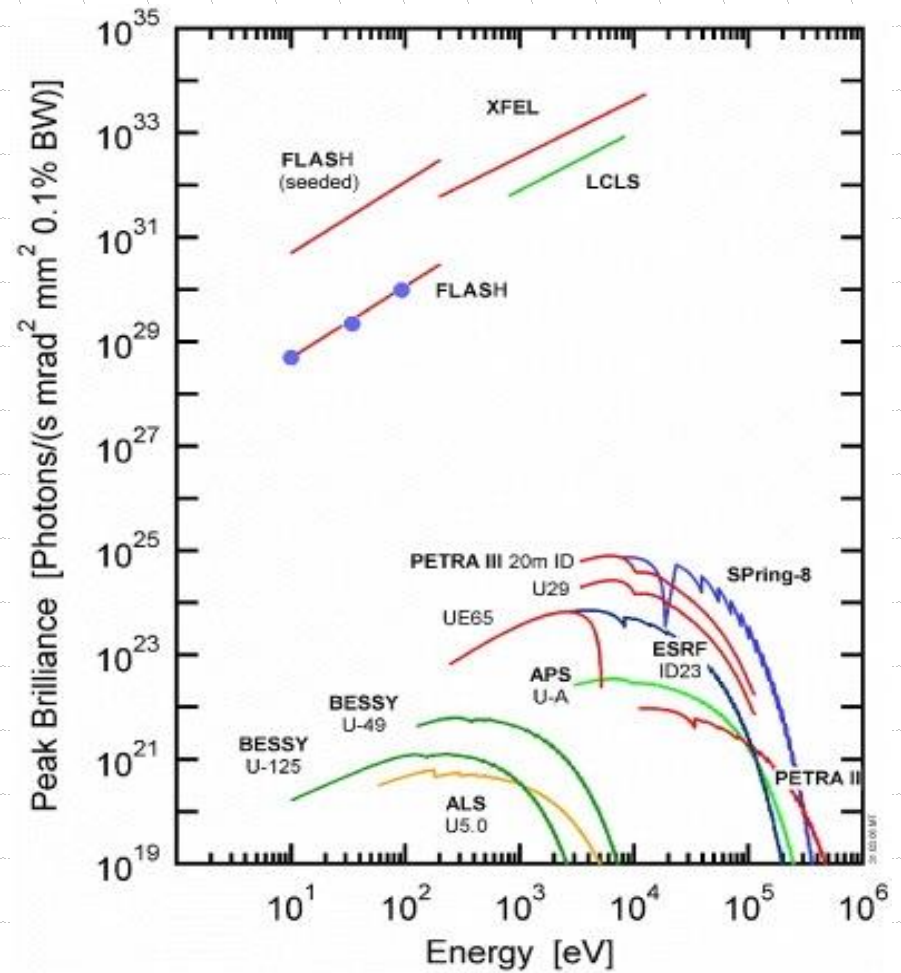
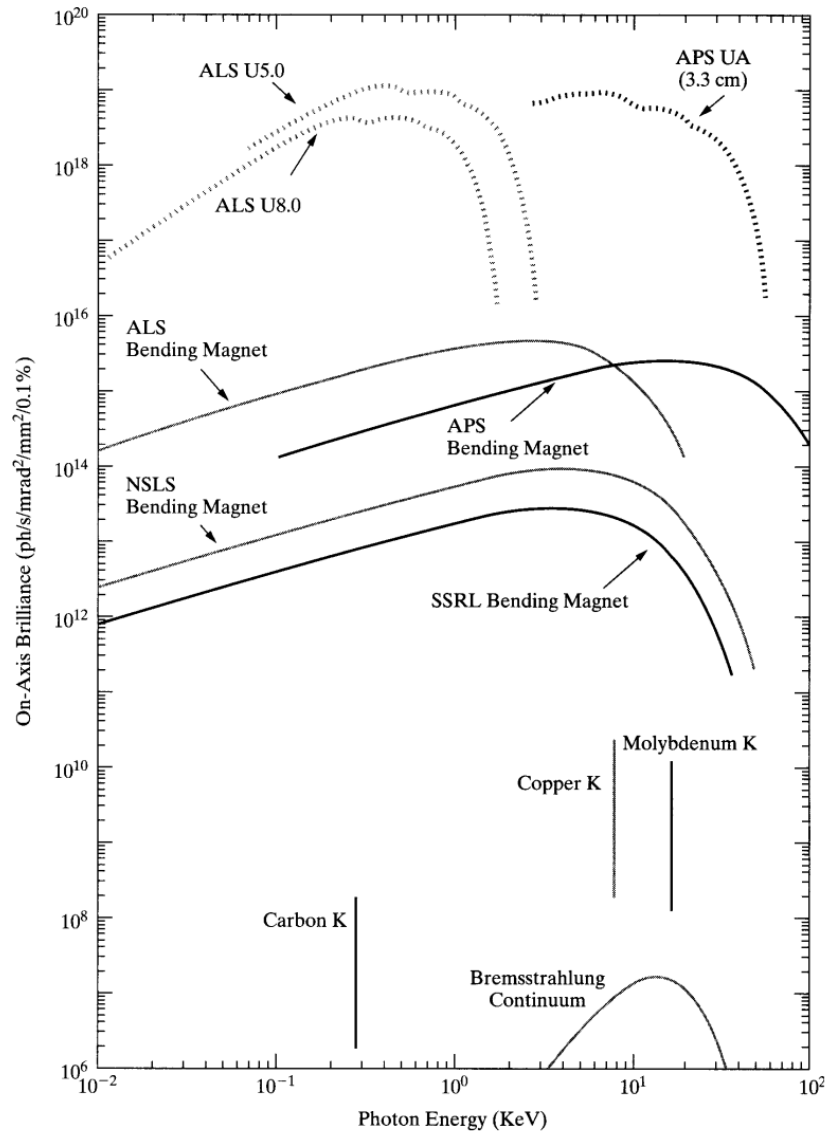



# **X-ray Safety**

Radiation safety depends on YOU!

# General

- ◆ A fundamental precept of radiation safety is that the individuals must assume the responsibility not only for their own safety, but must ensure that their actions do not result in hazards to others.

# General

## Electromagnetic Radiation

Type of Radiation	Typical Photon Energy
radio wave	1 $\mu\text{eV}$
microwave	1 meV
infrared	1 eV
red light	2 eV
violet light	3 eV
ultraviolet	4 eV
x-ray	100 KeV
gamma ray	1 MeV



# X-ray Diffractometers

- ◆ This is an example of an unenclosed (open) x-ray diffractometer. As the open x-ray beam of such an instrument can be extremely hazardous, it is far preferable to enclose the entire x-ray apparatus.

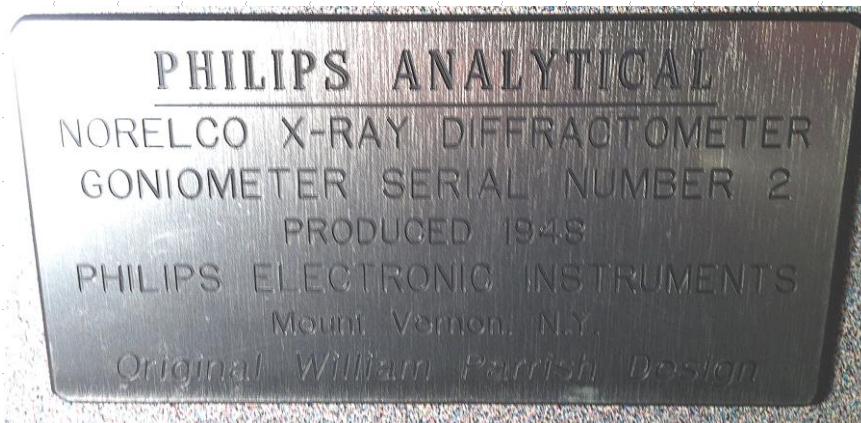

# X-ray Diffractometers

- ◆ This is another example of an unenclosed (open) x-ray diffractometer



- ◆ This is an example of properly enclosed and interlocked x-ray diffractometer.
- ◆ If a panel is opened while the x-ray diffractometer is being used, the interlock will either shut off the x-ray or close the shutter, preventing accidental exposure to personnel.
- ◆ The leaded glass windows not only afford a view of the x-ray apparatus, but also provide shielding against radiation.

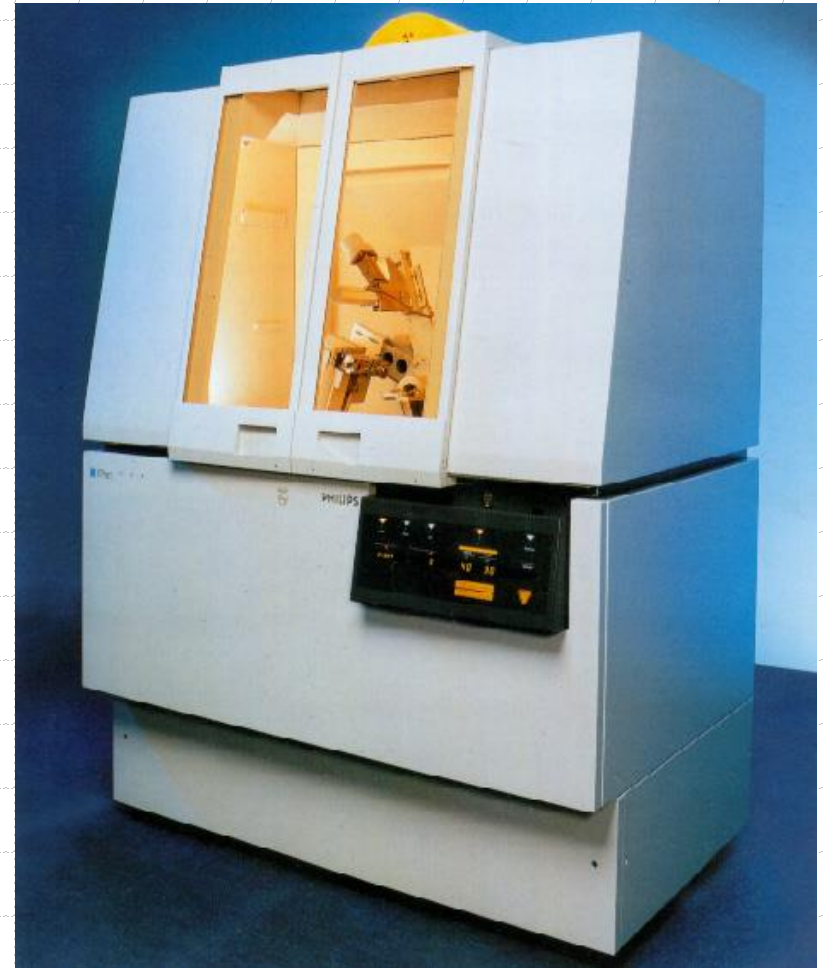

# Causes of Accidental Exposures

- ◆ Although most x-ray workers do not receive any measurable radiation above background, accidents related to x-ray devices have occurred when proper work procedures have not been followed. Failure to follow proper procedures has been the result of
  - rushing to complete a job,
  - fatigue,
  - illness,
  - personal problems,
  - lack of communication, or
  - complacency.

# Four Main Causes of Accidents

- ◆ Poor equipment configuration, e.g. unused beam ports not covered, interlock system is not engaged.
- ◆ Manipulation of equipment when energized, e.g. adjustment of samples or alignment of optics when x-ray beam is on.
- ◆ Equipment failure, e.g. shutter failure, warning light failure.
- ◆ Inadequate training or violation of procedure, e.g. incorrect use of equipment, overriding interlocks.



# Reducing External Exposure

- ◆ Three basic ways to reduce external exposure to radiation are to
  - minimize time,
  - maximize distance, and
  - use shielding.

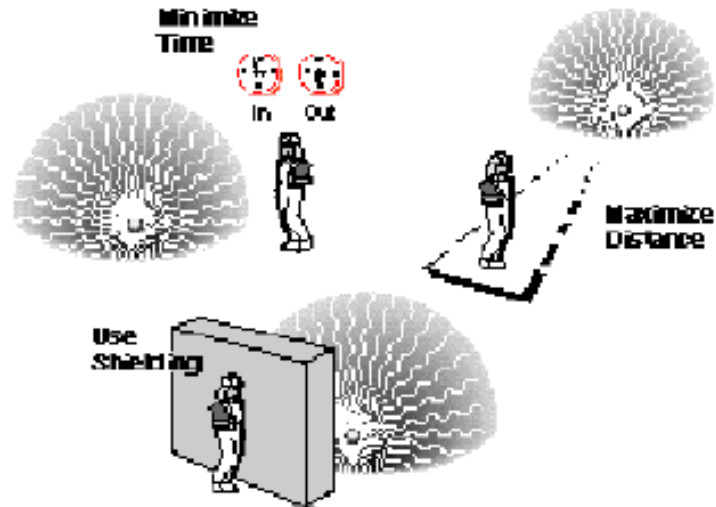

# Monitoring X-ray Exposure

## ◆ Finger Dosimeters

- Ring dosimeters provide accurate readings for the radiation you are receiving.
- By regularly reviewing Dose Exposure Reports, you'll be able to monitor radiation levels and limit the amount of exposure to your extremities.
- All rings consists of one natural lithium fluoride element and offer immersible, bar coded single-piece construction.



Let say you are exposed to a dose of 100 mrem/year...



# Life Expectancy Days Lost

Average estimated days lost due to daily activities

<b>Occupation</b>	<b>Days of Life Lost</b>
Being an unmarried male	3,500
Smoking (1 pack/day)	2,250
Being an unmarried female	1,600
Being a coal miner	1,100
Being 25% overweight	777
Drinking alcohol (US average)	365
Being a construction worker	227
Driving a motor vehicle	207
All industry	60
Being exposed to 100 mrem/year of radiation for 70 years	10
Drinking coffee	6

# Exposure Limits

	rem/year	
	General	Stanford
Adult workers	5.0	0.5
Eye lens	15.0	1.5
Skin, organ, extremities	50.0	5.0
Minors	0.5	0.05
Declared Pregnant Women	0.5	0.05
Members of the Public	0.1	0.01

# Exposure Limits

## Common Radiation Exposures

Coast to Coast Flight	3.0 mrem
Natural Background Radiation	150 – 300 mrem/year
Chest Radiograph	15 – 65 mrem/view
Screening Mammography	60 – 135 mrem/view
Computerized Body Tomography (20 slices)	3,000 – 6,000 mrem

## Biologically Significant Radiation Exposures

	mrem
Risk of contracting cancer increased 0.04%	1,000
Temporary Blood Count Change	25,000
Permanent sterilization in men	100,000
Permanent sterilization in women	250,000
Skin Erythema	300,000

# Radiological Signs

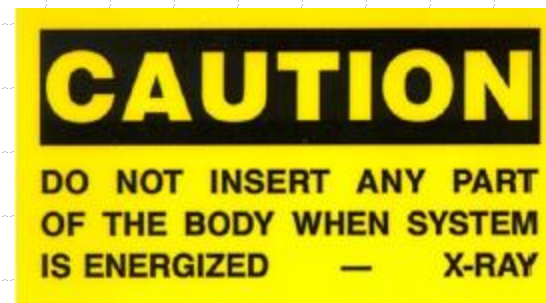
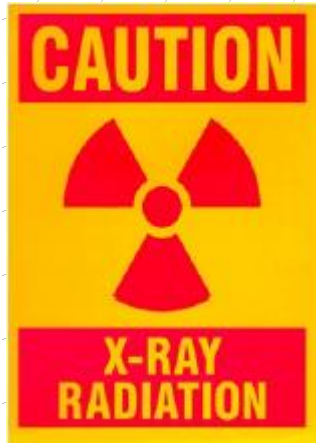

# Doug Menke

Email: [dmenke@stanford.edu](mailto:dmenke@stanford.edu)

Department: Environmental Health and Safety (EH&S)

Work phone: (650) 723-4723

Work address: Environmental Health & Safety

480 Oak Road

Stanford, California 94305-8007

<http://www.stanford.edu/group/glam/xlab/Main.htm>

<http://www.stanford.edu/group/glam/xlab/Safety/Authorization.htm>



http://web.stanford.edu/group/glam/xlab/Safety/Authorization.htm

← → ↻ web.stanford.edu/group/glam/xlab/Safety/Authorization.htm

X-ray Lab

X-ray Safety

Stanford University  
Geballe Laboratory for Advanced Materials

User Authorization

Links

News

Technique

X'Pert 1

X'Pert 2

Laue

Software

X-ray Safety

Links

Contact Info

**Steps to obtain access to the X-ray Lab:**

- Read [Safety Manual](#).
- Complete [Safety Questionnaire](#).
- Contact [Doug Menke](#) and make an appointment at Environmental Health & Safety Dept. ([EH&S](#)).
- Obtain [Safety Certificate](#) from EH&S and bring copy to X-ray Lab.
- Setup Badger account by joining [Stanford Nano Shared Facilities \(SNSF\)](#).
- Contact [X-ray Lab manager](#) and signup for x-ray diffraction training.

MATSCI 162/172