Lecture 2

Experimental Facts of Life

Assigned Reading:

| | |
|-----|---|
| E&R | 1 _{6,7} , 2 _{1,2,3,4,5} , 3 _{all} NOT 4 _{all} !!! |
| Li. | 1 _{all} , 2 _{3,5,6} NOT 2-4!!! |
| Ga. | 1 _{2,3,4} NOT 1-5!!! |
| Sh. | 3 |

We all know atoms are made of:

- electrons
 - Cathode rays in CRT monitors make bright spots. If they can be sprayed in such a manner, they must exist.
 - Alternatively, cloud chamber tracks can be observed.
- nuclei
 - α particles shot into atoms occasionally fly back, as per the experiments of Rutherford, Geiger, Marsden, and others.
 - Also, they are collided at places like the RHIC by people like Prof. Busza. If they can be collided, they must exist.

We also know that classically, atomic orbits are unstable. In spite of this, we are compelled to say the following.

Experimental result #1: atoms exist!

We also know from our previous discussions of color and hardness the following.

Experimental result #2: randomness exists!

As an aside, hard scattering to detect dense cores did not end with Rutherford, Geiger, and Marsden. Similar experiments in the 1960s of electrons off of protons showed that protons are made of 3 dense parts each with fractional (relative to the electron) charge, called quarks. This earned Kendall and Friedman of MIT and Taylor of Stanford the 1990 Nobel Prize.

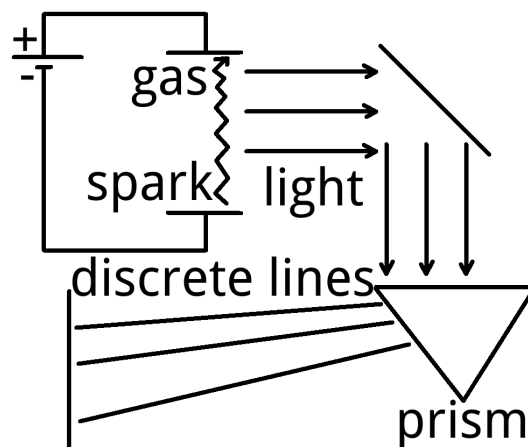

Figure 1: Discrete atomic spectra

Balmer noticed by being a little clever (but mostly obsessed) that spectral emission lines followed the formula

$$\lambda_n \approx (3646 \text{ angstrom}) \cdot \left(1 - \frac{4}{n^2}\right)^{-1} \text{ for } n \in \{3, 4, 5, \dots\}. \quad (0.1)$$

Rydberg and Ritz then found that

$$\lambda^{-1} = R \cdot (n_1^{-2} - n_2^{-2}) \text{ for } n_i \in \mathbb{Z}, n_2 > n_1 \quad (0.2)$$

where R is the Rydberg constant dependent on the particular element but independent of the emission series. Where did that come from? ¹

Experimental result #3: atomic spectra are discrete!

Regarding discrete spectra, let us consider light at a frequency ν and amplitude A . We measure a current I because light is liberating electrons from the metal in what is known as the *photoelectric effect*, so we tune the voltage ΔV to get $I = 0$. We expect that a more intense beam makes the electron more energetic, as the energy is proportional to the intensity A^2 , and $K \approx q_e \Delta V$, so ΔV needs to be bigger to make $I = 0$. We also expect this to be generally independent of ν .

What we instead find is that $\Delta V(I = 0)$ is *independent* of A correct to 1 part in 10^7 , ΔV varies *linearly* with ν , and there exists a minimum ν below which *no electrons* are liberated at any A !

¹Editor's note: where did that come from? I mean, am I supposed to explain the reason for the spectra right here and now, or leave it as an open question for readers to ponder?

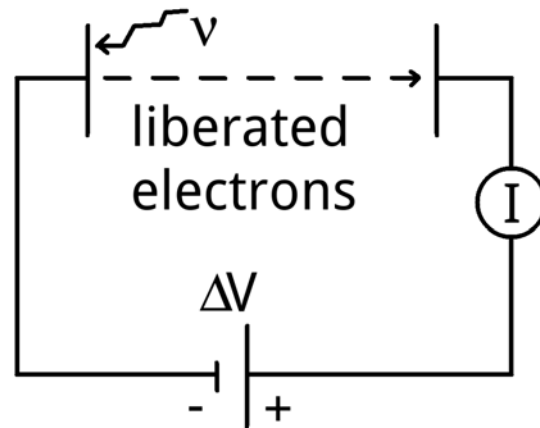
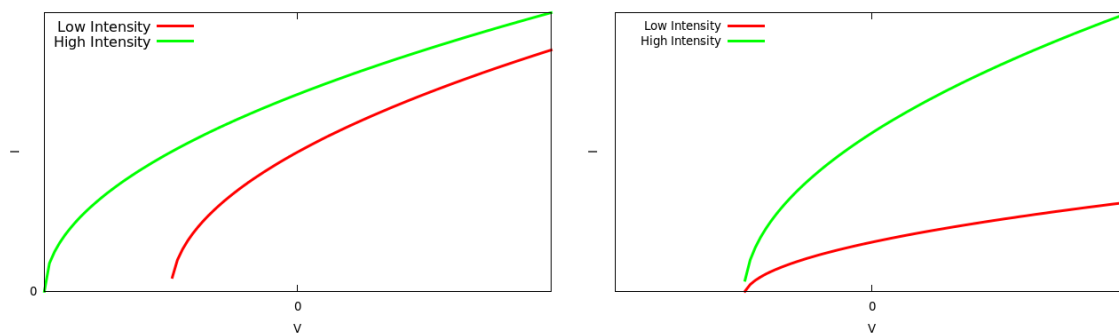

Figure 2: Photoelectric effect experimental schematic

Figure 3: Photoelectric dependence of I on V : expectation (top) versus reality (bottom)

Einstein's interpretation of this is that light comes in packets of definite energy $E = h\nu$, the intensity is proportional to the number of such packets, and the kinetic energy of an electron liberated from a metal by light is $K = h\nu - W$. A plot of the electron kinetic energy versus the light frequency yields a straight line of slope h , which is called the *Planck constant*. Another quantity \hbar defined by $h = 2\pi\hbar$ is much more often used in quantum mechanics, and while this is technically called the Dirac constant, it is often just called the Planck constant exactly because \hbar is used so much more often than h in calculations. This will be seen later on.

The consequences of this include that the intensity determines the *rate* of electron liberation, but for $\nu < \frac{W}{h}$, no electrons can be liberated regardless of intensity. Furthermore, you know $E = cp$ from 8.02 or 8.022, $\lambda\nu = c$ from 8.03, and $E = h\nu$ from Einstein's model. Therefore, $p = \frac{h}{\lambda}$. This means that the discrete packets of light with wavelength λ have a momentum p given by the previous formula.

Why is this weird? Well, we know that light is a wave; apart from what has been taught in

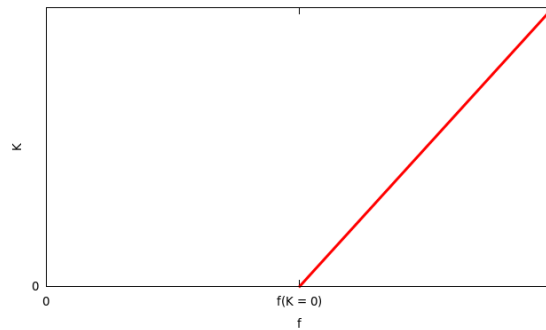

Figure 4: Electron kinetic energy versus light frequency

8.02 or 8.022, 8.03, and 8.033, the double-slit experiment seems fairly convincing!

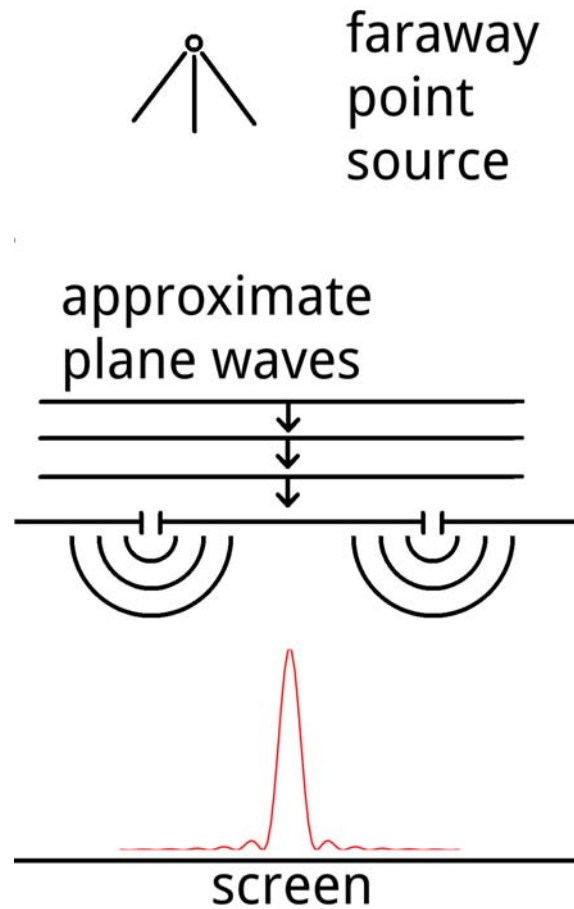

Figure 5: Schematic of double-slit interference and diffraction

One thing to ask is, where is the light when it hits the wall? In fact, it is everywhere, as it is

not localized. But the intensity shows an interference pattern. This implies that amplitudes, rather than intensities, add.

Let us try to investigate the fringe widths in the interference pattern further. Let us suppose that light from the two slits start in phase. If they coincide at a single point on the screen, they remain in phase if their path lengths differ by an integer multiple of the wavelength λ . If the horizontal distance D to the screen is much larger than the slit separation ℓ , then the phase matching length should equal the path length difference for constructive interference to occur

$$\ell \sin(\theta) = \lambda n.$$

If the beams meet on the screen a distance y from the slit positions projected onto the screen and if $\theta \ll 1$, then

$$\ell y \approx D \lambda n.$$

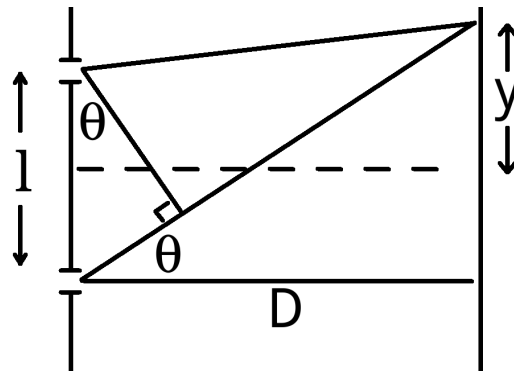

Figure 6: Geometry of double-slit interference and diffraction

Now accounting for the shape of the pattern, the information from the screen is of the magnitude and phase of the light. θ depends on y because the path to y varies:

$$\ell_1(y) = \sqrt{D^2 + \left(y - \frac{\ell}{2}\right)^2} \approx D + \frac{\left(y - \frac{\ell}{2}\right)^2}{2D},$$

while

$$\ell_2(y) \approx D + \frac{\left(y + \frac{\ell}{2}\right)^2}{2D}.$$

From this,

$$\theta_i(y) = \frac{2\pi}{\lambda} \ell_i(y).$$

As for magnitudes, $A_1 = A_2 = A_0$ because the slits are identical and pointlike. This means

$$A(y) = A_0 \cdot (e^{i\theta_1(y)} + e^{i\theta_2(y)}).$$

The intensity, up to a constant ensuring the correct dimensions, is

$$|A(y)|^2 = 2A_0^2 \cdot (1 + \cos(\theta_1(y) - \theta_2(y))),$$

which reduces to

$$|A(y)|^2 \approx 2A_0^2 \cdot (1 + \cos(\frac{2\pi\ell y}{\lambda D})).$$

This yields maxima at

$$\ell y = D\lambda n$$

as expected. Note that maxima correspond to constructive interference, while minima correspond to destructive interference. This comes from the fact that amplitudes add, and the intensity is the square of the amplitude.

The point is that in 8.03, you did the double-slit experiment and saw the interference fringes. This implies that light is a wave, which nicely fits the Maxwell equations. By contrast, chunks should behave differently!

Classically, particles sent through a double-slit screen onto another screen should hit the final screen at one localized point or the other, and intensities would sum directly with no interference terms. This seems to build credence for the idea that light is a wave and is not chunky.

To recapitulate, 8.02 and 8.022 say that light is an electromagnetic wave. From 8.03, light interferes with itself, so light should be a smooth continuum. Yet from 8.04, if light is applied to a metal, it comes only in chunks!

Experimental result #4: light comes in chunks!

Accompanying this is the fact that light has an energy and a momentum

$$E = h\nu \tag{0.3}$$

$$p = h\lambda^{-1}. \tag{0.4}$$

That's enough about light for now. What about atoms? Well, we are not as confident that they exist, so let us stick with electrons for now. While the properties of color and hardness in electrons are disturbing, we should be able to agree that if electrons are truly particles, they would be localized and would thus hit a screen in a slit experiment in exactly one spot. We can check this with a double-slit experiment.

It turns out that electrons interfere like waves even with themselves! If they were really particles, they would have followed only one of two paths: the path from the top slit to the end, or the path from the bottom slit to the end. We could use a wall to check which one is happening. Yet this produces the exact same conundrum as for the boxes from before for

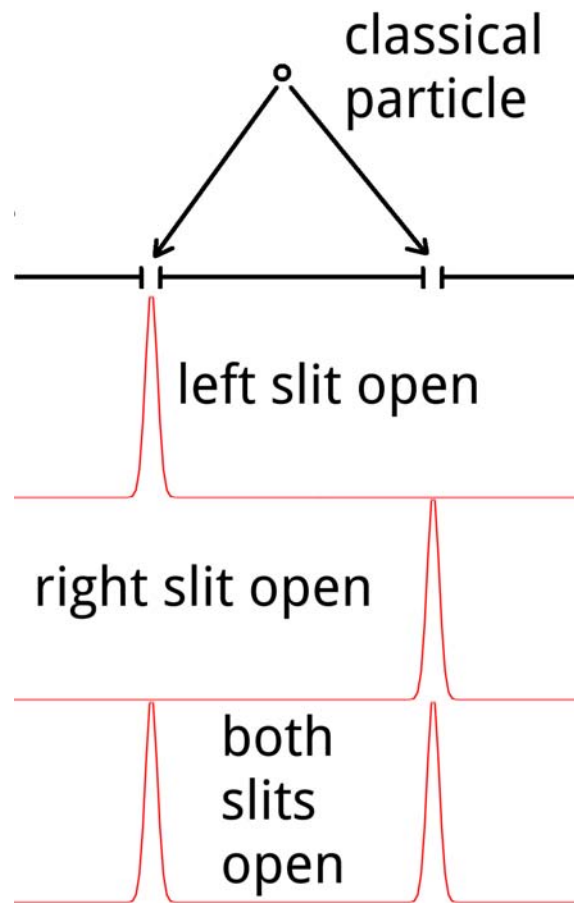

Figure 7: Classical particles in a double-slit experiment

the exact same reasons. Hence, the electron must be taking a superposition of the possible paths. So the electron is neither strictly a particle nor strictly a wave, but is just an electron.

But could we be a little more clever in trying to glean through which slit the electron passed? We could cheat by using very diffuse (low-energy) light. Examining one path would not be like blocking it, so there would be a mild deflection but the overall interference pattern should qualitatively be preserved.

The problem with this is that light is quantized. Every collision imparts a discrete $E = h\nu$ and $p = h\lambda^{-1}$; low intensity simply means the collisions are rare. And if the energy and momentum are low, the wavelength, which becomes the resolution of the electron's spatial location, becomes too large to remain meaningful.

Hence, determining through which slit an electron passes does away with the interference

pattern. This means that every force must be quantized like $E = h\nu$ and $p = h\lambda^{-1}$, or else the slit passage could be determined without messing with the interference pattern.

But are electrons waves then? Davisson and Germer sent a beam of electrons into a crystal and found the phenomenon of Bragg scattering. The path length difference between one layer of the crystal and the next is

$$\Delta\ell = 2\ell \sin(\theta)$$

for a square crystal of length ℓ . Constructive interference occurs when

$$\Delta\ell = \lambda n.$$

This means

$$\lambda^{-1} = \frac{n}{2\ell \sin(\theta)}.$$

Davisson and Germer also observed that

$$\frac{n}{2\ell \sin(\theta)} \approx \frac{\sqrt{2mq_e V_0}}{h} = \frac{\sqrt{2mE}}{h} = \frac{p}{h}.$$

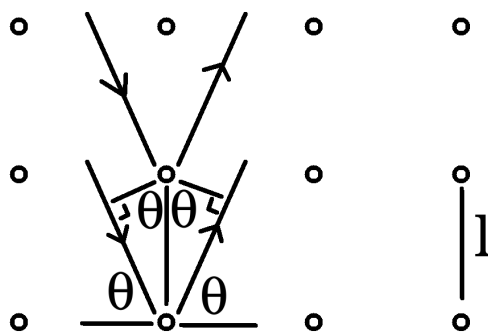

Figure 8: Davisson and Germer crystal diffraction

Experimental result #5: electrons interfere and diffract!

Accompanying this are the de Broglie relations

$$E = h\nu \tag{0.5}$$

$$p = h\lambda^{-1}. \tag{0.6}$$

MIT OpenCourseWare
<http://ocw.mit.edu>

8.04 Quantum Physics I
Spring 2013

For information about citing these materials or our Terms of Use, visit: <http://ocw.mit.edu/terms>.