

# CHAPTER 1 KEYS TO THE STUDY OF CHEMISTRY

---

## END-OF-CHAPTER PROBLEMS

- 1.1 Plan: If only the form of the particles has changed and not the composition of the particles, a physical change has taken place; if particles of a different composition result, a chemical change has taken place.  
Solution:  
a) The result in C represents a **chemical change** as the substances in A (red spheres) and B (blue spheres) have reacted to become a different substance (particles consisting of one red and one blue sphere) represented in C. There are molecules in C composed of the atoms from A and B.  
b) The result in D represents a **chemical change** as again the atoms in A and B have reacted to form molecules of a new substance.  
c) The change from C to D is a **physical change**. The substance is the same in both C and D (molecules consisting of one red sphere and one blue sphere) but is in the gas phase in C and in the liquid phase in D.  
d) The sample has the **same chemical properties** in both C and D since it is the same substance but has **different physical properties**.
- 1.2 Plan: Apply the definitions of the states of matter to a container. Next, apply these definitions to the examples. Gas molecules fill the entire container; the volume of a gas is the volume of the container. Solids and liquids have a definite volume. The volume of the container does not affect the volume of a solid or liquid.  
Solution:  
a) The helium fills the volume of the entire balloon. The addition or removal of helium will change the volume of a balloon. Helium is a **gas**.  
b) At room temperature, the mercury does not completely fill the thermometer. The surface of the **liquid** mercury indicates the temperature.  
c) The soup completely fills the bottom of the bowl, and it has a definite surface. The soup is a **liquid**, though it is possible that solid particles of food will be present.
- 1.3 Plan: Define the terms and apply these definitions to the examples.  
Solution:  
**Physical property** – A characteristic shown by a substance itself, without interacting with or changing into other substances.  
**Chemical property** – A characteristic of a substance that appears as it interacts with, or transforms into, other substances.  
a) The change in color (yellow–green and silvery to white), and the change in physical state (gas and metal to crystals) are examples of **physical properties**. The change in the physical properties indicates that a chemical change occurred. Thus, the interaction between chlorine gas and sodium metal producing sodium chloride is an example of a **chemical property**.  
b) The sand and the iron are still present. Neither sand nor iron became something else. Colors along with magnetism are **physical properties**. No chemical changes took place, so there are no chemical properties to observe.
- 1.4 Plan: Define the terms and apply these definitions to the examples.  
Solution:  
**Physical change** – A change in which the physical form (or state) of a substance, but not its composition, is altered.  
**Chemical change** – A change in which a substance is converted into a different substance with different composition and properties.  
a) The changes in the physical form are **physical changes**. The physical changes indicate that there is also a **chemical change**. Magnesium chloride has been converted to magnesium and chlorine.  
b) The changes in color and form are **physical changes**. The physical changes indicate that there is also a **chemical change**. Iron has been converted to a different substance, rust.

- 1.5 Plan: Apply the definitions of chemical and physical changes to the examples.  
Solution:  
a) Not a chemical change, but a **physical change** — simply cooling returns the soup to its original form.  
b) There is a **chemical change** — cooling the toast will not “un-toast” the bread.  
c) Even though the wood is now in smaller pieces, it is still wood. There has been no change in composition, thus this is a **physical change**, and not a chemical change.  
d) This is a **chemical change** converting the wood (and air) into different substances with different compositions. The wood cannot be “unburned.”
- 1.6 Plan: If there is a physical change, in which the composition of the substance has not been altered, the process can be reversed by a change in temperature. If there is a chemical change, in which the composition of the substance has been altered, the process cannot be reversed by changing the temperature.  
Solution:  
a) and c) **can be reversed** with temperature; the dew can evaporate and the ice cream can be refrozen.  
b) and d) involve chemical changes and **cannot be reversed** by changing the temperature since a chemical change has taken place.
- 1.7 Plan: A system has a higher potential energy before the energy is released (used).  
Solution:  
a) The exhaust is lower in energy than the fuel by an amount of energy equal to that released as the fuel burns. The **fuel** has a higher potential energy.  
b) **Wood**, like the fuel, is higher in energy by the amount released as the wood burns.
- 1.8 Plan: Kinetic energy is energy due to the motion of an object.  
Solution:  
a) **The sled sliding down the hill** has higher kinetic energy than the unmoving sled.  
b) **The water falling over the dam** (moving) has more kinetic energy than the water held by the dam.
- 1.9 **Observations** are the first step in the scientific approach. The first observation is that the toast has not popped out of the toaster. The next step is a **hypothesis** (tentative explanation) to explain the observation. The hypothesis is that the spring mechanism is stuck. Next, there will be a **test** of the hypothesis. In this case, the test is an additional observation — the bread is unchanged. This observation leads to a new hypothesis — the toaster is unplugged. This hypothesis leads to additional tests — seeing if the toaster is plugged in, and if it works when plugged into a different outlet. The final test on the toaster leads to a new hypothesis — there is a problem with the power in the kitchen. This hypothesis leads to the final test concerning the light in the kitchen.
- 1.10 A quantitative observation is easier to characterize and reproduce. A qualitative observation may be subjective and open to interpretation.  
a) This is **qualitative**. When has the sun completely risen?  
b) The astronaut’s mass may be measured; thus, this is **quantitative**.  
c) This is **qualitative**. Measuring the fraction of the ice above or below the surface would make this a quantitative measurement.  
d) The depth is known (measured) so this is **quantitative**.
- 1.11 A well-designed experiment must have the following essential features:  
1) There must be two variables that are expected to be related.  
2) There must be a way to control all the variables, so that only one at a time may be changed.  
3) The results must be reproducible.
- 1.12 A model begins as a simplified version of the observed phenomena, designed to account for the observed effects, explain how they take place, and to make predictions of experiments yet to be done. The model is improved by further experiments. It should be flexible enough to allow for modifications as additional experimental results are gathered.

1.13 The unit you begin with (feet) must be in the denominator to cancel. The unit desired (inches) must be in the numerator. The feet will cancel leaving inches. If the conversion is inverted the answer would be in units of feet squared per inch.

1.14 Plan: Review the table of conversions in the chapter or inside the back cover of the book. Write the conversion factor so that the unit initially given will cancel, leaving the desired unit.

Solution:

a) To convert from  $\text{in}^2$  to  $\text{cm}^2$ , use  $\frac{(2.54 \text{ cm})^2}{(1 \text{ in})^2}$ ; to convert from  $\text{cm}^2$  to  $\text{m}^2$ , use  $\frac{(1 \text{ m})^2}{(100 \text{ cm})^2}$

b) To convert from  $\text{km}^2$  to  $\text{m}^2$ , use  $\frac{(1000 \text{ m})^2}{(1 \text{ km})^2}$ ; to convert from  $\text{m}^2$  to  $\text{cm}^2$ , use  $\frac{(100 \text{ cm})^2}{(1 \text{ m})^2}$

c) This problem requires two conversion factors: one for distance and one for time. It does not matter which conversion is done first. Alternate methods may be used.

To convert distance, mi to m, use:

$$\left(\frac{1.609 \text{ km}}{1 \text{ mi}}\right)\left(\frac{1000 \text{ m}}{1 \text{ km}}\right) = 1.609 \times 10^3 \text{ m/mi}$$

To convert time, h to s, use:

$$\left(\frac{1 \text{ h}}{60 \text{ min}}\right)\left(\frac{1 \text{ min}}{60 \text{ s}}\right) = 1 \text{ h}/3600 \text{ s}$$

Therefore, the complete conversion factor is  $\left(\frac{1.609 \times 10^3 \text{ m}}{1 \text{ mi}}\right)\left(\frac{1 \text{ h}}{3600 \text{ s}}\right) = \frac{0.4469 \text{ m}\cdot\text{h}}{\text{mi}\cdot\text{s}}$ .

Do the units cancel when you start with a measurement of mi/h?

d) To convert from pounds (lb) to grams (g), use  $\frac{1000 \text{ g}}{2.205 \text{ lb}}$ .

To convert volume from  $\text{ft}^3$  to  $\text{cm}^3$  use,  $\left(\frac{(1 \text{ ft})^3}{(12 \text{ in})^3}\right)\left(\frac{(1 \text{ in})^3}{(2.54 \text{ cm})^3}\right) = 3.531 \times 10^{-5} \text{ ft}^3/\text{cm}^3$ .

1.15 Plan: Review the table of conversions in the chapter or inside the back cover of the book. Write the conversion factor so that the unit initially given will cancel, leaving the desired unit.

Solution:

a) This problem requires two conversion factors: one for distance and one for time. It does not matter which conversion is done first. Alternate methods may be used.

To convert distance, cm to in, use:  $\left(\frac{1 \text{ in}}{2.54 \text{ cm}}\right)$

To convert time, min to s, use:  $\left(\frac{1 \text{ min}}{60 \text{ s}}\right)$

b) To convert from  $\text{m}^3$  to  $\text{cm}^3$ , use  $\frac{(100 \text{ cm})^3}{(1 \text{ m})^3}$ ; to convert from  $\text{cm}^3$  to  $\text{in}^3$ , use  $\frac{(1 \text{ in})^3}{(2.54 \text{ cm})^3}$

c) This problem requires two conversion factors: one for distance and one for time. It does not matter which conversion is done first. Alternate methods may be used.

To convert distance, m to km, use:  $\left(\frac{1 \text{ km}}{1000 \text{ m}}\right)$

To convert time,  $s^2$  to  $h^2$ , use:

$$\left(\frac{(60\text{ s})^2}{(1\text{ min})^2}\right)\left(\frac{(60\text{ min})^2}{(1\text{ h})^2}\right) = \frac{3600\text{ s}^2}{\text{h}^2}$$

d) This problem requires two conversion factors: one for volume and one for time. It does not matter which conversion is done first. Alternate methods may be used.

To convert volume, gal to qt, use:  $\left(\frac{4\text{ qt}}{1\text{ gal}}\right)$ ; to convert qt to L, use:  $\left(\frac{1\text{ L}}{1.057\text{ qt}}\right)$

To convert time, h to min, use:  $\left(\frac{1\text{ h}}{60\text{ min}}\right)$

1.16 Plan: Review the definitions of extensive and intensive properties.

Solution:

An extensive property depends on the amount of material present. An intensive property is the same regardless of how much material is present.

a) Mass is an **extensive property**. Changing the amount of material will change the mass.

b) Density is an **intensive property**. Changing the amount of material changes both the mass and the volume, but the ratio (density) remains fixed.

c) Volume is an **extensive property**. Changing the amount of material will change the size (volume).

d) The melting point is an **intensive property**. The melting point depends on the substance, not on the amount of substance.

1.17 Plan: Review the definitions of mass and weight.

Solution:

**Mass** is the quantity of material present, while **weight** is the interaction of gravity on mass. An object has a definite mass regardless of its location; its weight will vary with location. The lower gravitational attraction on the Moon will make an object appear to have approximately one-sixth its Earth weight. The object has the same mass on the Moon and on Earth.

1.18 Plan: Density =  $\frac{\text{mass}}{\text{volume}}$ . An increase in mass or a decrease in volume will increase the density. A decrease

in density will result if the mass is decreased or the volume increased.

Solution:

a) Density **increases**. The mass of the chlorine gas is not changed, but its volume is smaller.

b) Density **remains the same**. Neither the mass nor the volume of the solid has changed.

c) Density **decreases**. Water is one of the few substances that expands on freezing. The mass is constant, but the volume increases.

d) Density **increases**. Iron, like most materials, contracts on cooling; thus the volume decreases while the mass does not change.

e) Density **remains the same**. The water does not alter either the mass or the volume of the diamond.

1.19 Plan: Review the definitions of heat and temperature. The two temperature values must be compared using one temperature scale, either Celsius or Fahrenheit.

Solution:

Heat is the energy that flows between objects at different temperatures while temperature is the measure of how hot or cold a substance is relative to another substance. Heat is an **extensive property** while temperature is an **intensive property**. It takes more heat to boil a gallon of water than to boil a teaspoon of water. However, both water samples boil at the same temperature.

Convert  $65^\circ\text{C}$  to  $^\circ\text{F}$ :  $T(\text{in } ^\circ\text{F}) = \frac{9}{5}T(\text{in } ^\circ\text{C}) + 32 = \frac{9}{5}(65^\circ\text{C}) + 32 = 149^\circ\text{F}$

A temperature of  $65^\circ\text{C}$  is  $149^\circ\text{F}$ . Heat will flow from the hot water ( $65^\circ\text{C}$  or  $149^\circ\text{F}$ ) to the cooler water ( $65^\circ\text{F}$ ). The  $65^\circ\text{C}$  water contains more heat than the cooler water.

1.20 There are two differences in the Celsius and Fahrenheit scales (size of a degree and the zero point), so a simple one-step conversion will not work. The size of a degree is the same for the Celsius and Kelvin scales; only the zero point is different so a one-step conversion is sufficient.

1.21 Plan: Use conversion factors from the inside back cover:  $1 \text{ pm} = 10^{-12} \text{ m}$ ;  $10^{-9} \text{ m} = 1 \text{ nm}$ .

Solution:

$$\text{Radius (nm)} = (1430 \text{ pm}) \left( \frac{10^{-12} \text{ m}}{1 \text{ pm}} \right) \left( \frac{1 \text{ nm}}{10^{-9} \text{ m}} \right) = \mathbf{1.43 \text{ nm}}$$

1.22 Plan: Use conversion factors from the inside back cover:  $10^{-12} \text{ m} = 1 \text{ pm}$ ;  $1 \text{ pm} = 0.01 \text{ \AA}$ .

Solution:

$$\text{Radius (\AA)} = (2.22 \times 10^{-10} \text{ m}) \left( \frac{1 \text{ pm}}{10^{-12} \text{ m}} \right) \left( \frac{0.01 \text{ \AA}}{1 \text{ pm}} \right) = \mathbf{2.22 \text{ \AA}}$$

1.23 Plan: Use conversion factors  $(1 \text{ cm})^2 = (0.01 \text{ m})^2$ ;  $(1000 \text{ m})^2 = (1 \text{ km})^2$  to express the area in  $\text{km}^2$ . To calculate the cost of the patch, use the conversion factor:  $(2.54 \text{ cm})^2 = (1 \text{ in})^2$ .

Solution:

$$\text{a) Area (km}^2\text{)} = (20.7 \text{ cm}^2) \left( \frac{(0.01 \text{ m})^2}{(1 \text{ cm})^2} \right) \left( \frac{(1 \text{ km})^2}{(1000 \text{ m})^2} \right) = \mathbf{2.07 \times 10^{-9} \text{ km}^2}$$

$$\text{b) Cost} = (20.7 \text{ cm}^2) \left( \frac{(1 \text{ in})^2}{(2.54 \text{ cm})^2} \right) \left( \frac{\$3.25}{1 \text{ in}^2} \right) = 10.4276 = \mathbf{\$10.43}$$

1.24 Plan: Use conversion factors  $(1 \text{ mm})^2 = (10^{-3} \text{ m})^2$ ;  $(0.01 \text{ m})^2 = (1 \text{ cm})^2$ ;  $(2.54 \text{ cm})^2 = (1 \text{ in})^2$ ;  $(12 \text{ in})^2 = (1 \text{ ft})^2$  to express the area in  $\text{ft}^2$ .

Solution:

$$\text{a) Area (ft}^2\text{)} = (7903 \text{ mm}^2) \left( \frac{(10^{-3} \text{ m})^2}{(1 \text{ mm})^2} \right) \left( \frac{(1 \text{ cm})^2}{(0.01 \text{ m})^2} \right) \left( \frac{(1 \text{ in})^2}{(2.54 \text{ cm})^2} \right) \left( \frac{(1 \text{ ft})^2}{(12 \text{ in})^2} \right)$$

$$= 8.5067 \times 10^{-2} = \mathbf{8.507 \times 10^{-2} \text{ ft}^2}$$

$$\text{b) Time (s)} = (7903 \text{ mm}^2) \left( \frac{45 \text{ s}}{135 \text{ mm}^2} \right) = 2.634333 \times 10^3 = \mathbf{2.6 \times 10^3 \text{ s}}$$

1.25 Plan: Mass in g is converted to kg in part a) with the conversion factor  $1000 \text{ g} = 1 \text{ kg}$ ; mass in g is converted to lb in part b) with the conversion factors  $1000 \text{ g} = 1 \text{ kg}$ ;  $1 \text{ kg} = 2.205 \text{ lb}$ . Volume in  $\text{cm}^3$  is converted to  $\text{m}^3$  with the conversion factor  $(1 \text{ cm})^3 = (0.01 \text{ m})^3$  and to  $\text{ft}^3$  with the conversion factors  $(2.54 \text{ cm})^3 = (1 \text{ in})^3$ ;  $(12 \text{ in})^3 = (1 \text{ ft})^3$ . The conversions may be performed in any order.

Solution:

$$\text{a) Density (kg/m}^3\text{)} = \left( \frac{5.52 \text{ g}}{\text{cm}^3} \right) \left( \frac{(1 \text{ cm})^3}{(0.01 \text{ m})^3} \right) \left( \frac{1 \text{ kg}}{1000 \text{ g}} \right) = \mathbf{5.52 \times 10^3 \text{ kg/m}^3}$$

$$\text{b) Density (lb/ft}^3\text{)} = \left( \frac{5.52 \text{ g}}{\text{cm}^3} \right) \left( \frac{(2.54 \text{ cm})^3}{(1 \text{ in})^3} \right) \left( \frac{(12 \text{ in})^3}{(1 \text{ ft})^3} \right) \left( \frac{1 \text{ kg}}{1000 \text{ g}} \right) \left( \frac{2.205 \text{ lb}}{1 \text{ kg}} \right) = 344.661 = \mathbf{345 \text{ lb/ft}^3}$$

1.26 Plan: Length in m is converted to km in part a) with the conversion factor  $1000 \text{ m} = 1 \text{ km}$ ; length in m is converted to mi in part b) with the conversion factors  $1000 \text{ m} = 1 \text{ km}$ ;  $1 \text{ km} = 0.62 \text{ mi}$ . Time is converted using the conversion factors  $60 \text{ s} = 1 \text{ min}$ ;  $60 \text{ min} = 1 \text{ h}$ . The conversions may be performed in any order.

Solution:

$$\text{a) Velocity (km/h)} = \left( \frac{2.998 \times 10^8 \text{ m}}{1 \text{ s}} \right) \left( \frac{60 \text{ s}}{1 \text{ min}} \right) \left( \frac{60 \text{ min}}{1 \text{ h}} \right) \left( \frac{1 \text{ km}}{10^3 \text{ m}} \right) = 1.07928 \times 10^9 = \mathbf{1.079 \times 10^9 \text{ km/h}}$$

$$\text{b) Velocity (mi/min)} = \left( \frac{2.998 \times 10^8 \text{ m}}{1 \text{ s}} \right) \left( \frac{60 \text{ s}}{1 \text{ min}} \right) \left( \frac{1 \text{ km}}{10^3 \text{ m}} \right) \left( \frac{0.62 \text{ mi}}{1 \text{ km}} \right) = 1.11526 \times 10^7 = \mathbf{1.1 \times 10^7 \text{ mi/min}}$$

- 1.27 Plan: Use the conversion factors  $(1 \mu\text{m})^3 = (1 \times 10^{-6} \text{ m})^3$ ;  $(1 \times 10^{-3} \text{ m})^3 = (1 \text{ mm})^3$  to convert to  $\text{mm}^3$ . To convert to L, use the conversion factors  $(1 \mu\text{m})^3 = (1 \times 10^{-6} \text{ m})^3$ ;  $(1 \times 10^{-2} \text{ m})^3 = (1 \text{ cm})^3$ ;  $1 \text{ cm}^3 = 1 \text{ mL}$ ;  $1 \text{ mL} = 1 \times 10^{-3} \text{ L}$ .

Solution:

$$\text{a) Volume (mm}^3\text{)} = \left( \frac{2.56 \mu\text{m}^3}{\text{cell}} \right) \left( \frac{(1 \times 10^{-6} \text{ m})^3}{(1 \mu\text{m})^3} \right) \left( \frac{(1 \text{ mm})^3}{(1 \times 10^{-3} \text{ m})^3} \right) = \mathbf{2.56 \times 10^{-9} \text{ mm}^3/\text{cell}}$$

$$\begin{aligned} \text{b) Volume (L)} &= (10^5 \text{ cells}) \left( \frac{2.56 \mu\text{m}^3}{\text{cell}} \right) \left( \frac{(1 \times 10^{-6} \text{ m})^3}{(1 \mu\text{m})^3} \right) \left( \frac{(1 \text{ cm})^3}{(1 \times 10^{-2} \text{ m})^3} \right) \left( \frac{1 \text{ mL}}{1 \text{ cm}^3} \right) \left( \frac{1 \times 10^{-3} \text{ L}}{1 \text{ mL}} \right) \\ &= 2.56 \times 10^{-10} = \mathbf{10^{-10} \text{ L}} \end{aligned}$$

- 1.28 Plan: For part a), convert from qt to mL (1 qt = 946.4 mL) to L (1 mL =  $1 \times 10^{-3}$  L) to  $\text{m}^3$  (1 L =  $10^{-3} \text{ m}^3$ ). For part b), convert from gal to qt (1 gal = 4 qt) to mL (1 qt = 946.4 mL) to L (1 mL =  $10^{-3}$  L).

Solution:

$$\text{a) Volume (m}^3\text{)} = (1 \text{ qt}) \left( \frac{946.4 \text{ mL}}{1 \text{ qt}} \right) \left( \frac{10^{-3} \text{ L}}{1 \text{ mL}} \right) \left( \frac{10^{-3} \text{ m}^3}{1 \text{ L}} \right) = \mathbf{9.464 \times 10^{-4} \text{ m}^3}$$

$$\text{b) Volume (L)} = (835 \text{ gal}) \left( \frac{4 \text{ qt}}{1 \text{ gal}} \right) \left( \frac{946.4 \text{ mL}}{1 \text{ qt}} \right) \left( \frac{10^{-3} \text{ L}}{1 \text{ mL}} \right) = 3.160976 \times 10^3 = \mathbf{3.16 \times 10^3 \text{ L}}$$

- 1.29 Plan: The mass of the mercury in the vial is the mass of the vial filled with mercury minus the mass of the empty vial. Use the density of mercury and the mass of the mercury in the vial to find the volume of mercury and thus the volume of the vial. Once the volume of the vial is known, that volume is used in part b. The density of water is used to find the mass of the given volume of water. Add the mass of water to the mass of the empty vial.

Solution:

$$\text{a) Mass (g) of mercury} = \text{mass of vial and mercury} - \text{mass of vial} = 185.56 \text{ g} - 55.32 \text{ g} = 130.24 \text{ g}$$

$$\text{Volume (cm}^3\text{) of mercury} = \text{volume of vial} = (130.24 \text{ g}) \left( \frac{1 \text{ cm}^3}{13.53 \text{ g}} \right) = 9.626016 = \mathbf{9.626 \text{ cm}^3}$$

$$\text{b) Volume (cm}^3\text{) of water} = \text{volume of vial} = 9.626016 \text{ cm}^3$$

$$\text{Mass (g) of water} = (9.626016 \text{ cm}^3) \left( \frac{0.997 \text{ g}}{1 \text{ cm}^3} \right) = 9.59714 \text{ g water}$$

$$\text{Mass (g) of vial filled with water} = \text{mass of vial} + \text{mass of water} = 55.32 \text{ g} + 9.59714 \text{ g} = 64.91714 = \mathbf{64.92 \text{ g}}$$

- 1.30 Plan: The mass of the water in the flask is the mass of the flask and water minus the mass of the empty flask. Use the density of water and the mass of the water in the flask to find the volume of water and thus the volume of the flask. Once the volume of the flask is known, that volume is used in part b. The density of chloroform is used to find the mass of the given volume of chloroform. Add the mass of the chloroform to the mass of the empty flask.

Solution:

$$\text{a) Mass (g) of water} = \text{mass of flask and water} - \text{mass of flask} = 489.1 \text{ g} - 241.3 \text{ g} = 247.8 \text{ g}$$

$$\text{Volume (cm}^3\text{) of water} = \text{volume of flask} = (247.8 \text{ g}) \left( \frac{1 \text{ cm}^3}{1.00 \text{ g}} \right) = 247.8 = \mathbf{248 \text{ cm}^3}$$

$$\text{b) Volume (cm}^3\text{) of chloroform} = \text{volume of flask} = 247.8 \text{ cm}^3$$

$$\text{Mass (g) of chloroform} = (247.8 \text{ cm}^3) \left( \frac{1.48 \text{ g}}{\text{cm}^3} \right) = 366.744 \text{ g chloroform}$$

$$\begin{aligned} \text{Mass (g) of flask and chloroform} &= \text{mass of flask} + \text{mass of chloroform} = 241.3 \text{ g} + 366.744 \text{ g} \\ &= 608.044 \text{ g} = \mathbf{608 \text{ g}} \end{aligned}$$

- 1.31 Plan: Calculate the volume of the cube using the relationship  $\text{Volume} = (\text{length of side})^3$ . The length of side in mm must be converted to cm so that volume will have units of  $\text{cm}^3$ . Divide the mass of the cube by the volume to find density.

Solution:

$$\text{Side length (cm)} = (15.6 \text{ mm}) \left( \frac{10^{-3} \text{ m}}{1 \text{ mm}} \right) \left( \frac{1 \text{ cm}}{10^{-2} \text{ m}} \right) = 1.56 \text{ cm} \quad (\text{convert to cm to match density unit})$$

$$\text{Al cube volume (cm}^3\text{)} = (\text{length of side})^3 = (1.56 \text{ cm})^3 = 3.7964 \text{ cm}^3$$

$$\text{Density (g/cm}^3\text{)} = \frac{\text{mass}}{\text{volume}} = \frac{10.25 \text{ g}}{3.7964 \text{ cm}^3} = 2.69993 = \mathbf{2.70 \text{ g/cm}^3}$$

- 1.32 Plan: Use the relationship  $c = 2\pi r$  to find the radius of the sphere and the relationship  $V = 4/3\pi r^3$  to find the volume of the sphere. The volume in  $\text{mm}^3$  must be converted to  $\text{cm}^3$ . Divide the mass of the sphere by the volume to find density.

Solution:

$$c = 2\pi r$$

$$\text{Radius (mm)} = \frac{c}{2\pi} = \frac{32.5 \text{ mm}}{2\pi} = 5.17254 \text{ mm}$$

$$\text{Volume (mm}^3\text{)} = \frac{4}{3}\pi r^3 = \left( \frac{4}{3} \right) \pi (5.17254 \text{ mm})^3 = 579.6958 \text{ mm}^3$$

$$\text{Volume (cm}^3\text{)} = (579.6958 \text{ mm}^3) \left( \frac{10^{-3} \text{ m}}{1 \text{ mm}} \right)^3 \left( \frac{1 \text{ cm}}{10^{-2} \text{ m}} \right)^3 = 0.5796958 \text{ cm}^3$$

$$\text{Density (g/cm}^3\text{)} = \frac{\text{mass}}{\text{volume}} = \frac{4.20 \text{ g}}{0.5796958 \text{ cm}^3} = 7.24518 = \mathbf{7.25 \text{ g/cm}^3}$$

- 1.33 Plan: Use the equations given in the text for converting between the three temperature scales.

Solution:

$$\text{a) } T (\text{in } ^\circ\text{C}) = [T (\text{in } ^\circ\text{F}) - 32] \frac{5}{9} = [68^\circ\text{F} - 32] \frac{5}{9} = \mathbf{20.^\circ\text{C}}$$

$$T (\text{in K}) = T (\text{in } ^\circ\text{C}) + 273.15 = 20.^\circ\text{C} + 273.15 = 293.15 = \mathbf{293 \text{ K}}$$

$$\text{b) } T (\text{in K}) = T (\text{in } ^\circ\text{C}) + 273.15 = -164^\circ\text{C} + 273.15 = 109.15 = \mathbf{109 \text{ K}}$$

$$T (\text{in } ^\circ\text{F}) = \frac{9}{5} T (\text{in } ^\circ\text{C}) + 32 = \frac{9}{5} (-164^\circ\text{C}) + 32 = -263.2 = \mathbf{-263^\circ\text{F}}$$

$$\text{c) } T (\text{in } ^\circ\text{C}) = T (\text{in K}) - 273.15 = 0 \text{ K} - 273.15 = -273.15 = \mathbf{-273^\circ\text{C}}$$

$$T (\text{in } ^\circ\text{F}) = \frac{9}{5} T (\text{in } ^\circ\text{C}) + 32 = \frac{9}{5} (-273.15^\circ\text{C}) + 32 = -459.67 = \mathbf{-460.^\circ\text{F}}$$

- 1.34 Plan: Use the equations given in the text for converting between the three temperature scales.

Solution:

$$\text{a) } T (\text{in } ^\circ\text{C}) = [T (\text{in } ^\circ\text{F}) - 32] \frac{5}{9} = [106^\circ\text{F} - 32] \frac{5}{9} = 41.111 = \mathbf{41.^\circ\text{C}}$$

$$(106 - 32) = 74 \quad \text{This limits the significant figures.}$$

$$T (\text{in K}) = T (\text{in } ^\circ\text{C}) + 273.15 = 41.111^\circ\text{C} + 273.15 = 314.261 = \mathbf{314 \text{ K}}$$

$$\begin{aligned} \text{b) } T (\text{in } ^\circ\text{F}) &= \frac{9}{5} T (\text{in } ^\circ\text{C}) + 32 = \frac{9}{5} (3410^\circ\text{C}) + 32 = \mathbf{6170^\circ\text{F}} \\ T (\text{in K}) &= T (\text{in } ^\circ\text{C}) + 273.15 = 3410^\circ\text{C} + 273 = \mathbf{3683 K} \\ \text{c) } T (\text{in } ^\circ\text{C}) &= T (\text{in K}) - 273.15 = 6.1 \times 10^3 \text{ K} - 273 = 5.827 \times 10^3 = \mathbf{5.8 \times 10^3^\circ\text{C}} \\ T (\text{in } ^\circ\text{F}) &= \frac{9}{5} T (\text{in } ^\circ\text{C}) + 32 = \frac{9}{5} (5827^\circ\text{C}) + 32 = 1.0521 \times 10^4 = \mathbf{1.1 \times 10^4^\circ\text{F}} \end{aligned}$$

- 1.35 Plan: Find the volume occupied by each metal by taking the difference between the volume of water and metal and the initial volume of the water (25.0 mL). Divide the mass of the metal by the volume of the metal to calculate density. Use the density value of each metal to identify the metal.

Solution:

Cylinder A: volume of metal = [volume of water + metal] – [volume of water]  
 volume of metal = 28.2 mL – 25.0 mL = 3.2 mL

$$\text{Density} = \frac{\text{mass}}{\text{volume}} = \frac{25.0 \text{ g}}{3.2 \text{ mL}} = 7.81254 = \mathbf{7.8 \text{ g/mL}}$$

Cylinder A contains **iron**.

Cylinder B: volume of metal = [volume of water + metal] – [volume of water]  
 volume of metal = 27.8 mL – 25.0 mL = 2.8 mL

$$\text{Density} = \frac{\text{mass}}{\text{volume}} = \frac{25.0 \text{ g}}{2.8 \text{ mL}} = 8.92857 = \mathbf{8.9 \text{ g/mL}}$$

Cylinder B contains **nickel**.

Cylinder C: volume of metal = [volume of water + metal] – [volume of water]  
 volume of metal = 28.5 mL – 25.0 mL = 3.5 mL

$$\text{Density} = \frac{\text{mass}}{\text{volume}} = \frac{25.0 \text{ g}}{3.5 \text{ mL}} = 7.14286 = \mathbf{7.1 \text{ g/mL}}$$

Cylinder C contains **zinc**.

- 1.36 Plan: Use 1 in = 2.54 cm to convert length in inches to cm; use 1 cm = 10<sup>-2</sup> m to convert cm to m.

Solution:

$$\text{Length (m)} = 0.025 \text{ inch} \left( \frac{2.54 \text{ cm}}{1 \text{ inch}} \right) \left( \frac{10^{-2} \text{ m}}{1 \text{ cm}} \right) = 6.35 \times 10^{-4} = \mathbf{6.4 \times 10^{-4} \text{ m}}$$

- 1.37 Plan: Use 1 nm = 10<sup>-9</sup> m to convert wavelength in nm to m. To convert wavelength in pm to Å, use 1 pm = 0.01 Å.

Solution:

$$\text{a) Wavelength (m)} = (247 \text{ nm}) \left( \frac{10^{-9} \text{ m}}{1 \text{ nm}} \right) = \mathbf{2.47 \times 10^{-7} \text{ m}}$$

$$\text{b) Wavelength (Å)} = (6760 \text{ pm}) \left( \frac{0.01 \text{ Å}}{1 \text{ pm}} \right) = \mathbf{67.6 \text{ Å}}$$

- 1.38 Plan: Convert the mass of gold in troy oz to mass in grams and use the density to convert the mass of gold to volume of gold in cm<sup>3</sup>. Divide the volume of gold by the thickness of the gold foil to find the area of gold in in<sup>2</sup>. In part b, find the amount of gold in troy oz that can be purchased, convert troy oz to g, and use the density to convert that mass of gold to volume of gold in cm<sup>3</sup>. To find the area of the gold foil, divide the volume by the thickness of the gold foil, expressed in cm.

Solution:

$$\text{a) } (2.0 \text{ tr. oz}) \left( \frac{31.1 \text{ g}}{1 \text{ tr. oz}} \right) \left( \frac{\text{cm}^3}{19.3 \text{ g}} \right) \left( \frac{1 \text{ in}}{2.54 \text{ cm}} \right)^3 \left( \frac{1}{1.6 \times 10^{-5} \text{ in}} \right) = 1.229 \times 10^4 = \mathbf{1.2 \times 10^4 \text{ in}^2}$$

$$\text{b) } (\$75.00) \left( \frac{1 \text{ tr. oz}}{\$20.00} \right) \left( \frac{31.1 \text{ g}}{1 \text{ tr. oz}} \right) \left( \frac{\text{cm}^3}{19.3 \text{ g}} \right) \left( \frac{1}{1.6 \times 10^{-5} \text{ in}} \right) \left( \frac{1 \text{ in}}{2.54 \text{ cm}} \right) = 1.4869 \times 10^5 = \mathbf{1.49 \times 10^5 \text{ cm}^2}$$



- 1.39 Plan: Calculate the volume of the cylinder in  $\text{cm}^3$  by using the equation for the volume of a cylinder. The diameter of the cylinder must be halved to find the radius. Convert the volume in  $\text{cm}^3$  to  $\text{dm}^3$  by using the conversion factors  $(1 \text{ cm})^3 = (10^{-2} \text{ m})^3$  and  $(10^{-1} \text{ m})^3 = (1 \text{ dm})^3$ .

Solution:

$$\text{Radius} = \text{diameter}/2 = 0.85 \text{ cm}/2 = 0.425 \text{ cm}$$

$$\text{Volume (cm}^3\text{)} = \pi r^2 h = \pi(0.425 \text{ cm})^2(9.5 \text{ cm}) = 5.3907766 \text{ cm}^3$$

$$\text{Volume (dm}^3\text{)} = \left(5.3907766 \text{ cm}^3\right) \left(\frac{10^{-2} \text{ m}}{1 \text{ cm}}\right)^3 \left(\frac{1 \text{ dm}}{10^{-1} \text{ m}}\right)^3 = 5.39078 \times 10^{-3} = \mathbf{5.4 \times 10^{-3} \text{ dm}^3}$$

- 1.40 Plan: Use the percent of copper in the ore to find the mass of copper in 5.01 lb of ore. Convert the mass in lb to mass in g. The density of copper is used to find the volume of that mass of copper. Use the volume equation for a cylinder to calculate the height of the cylinder (the length of wire); the diameter of the wire is used to find the radius which must be expressed in units of cm. Length of wire in cm must be converted to m.

Solution:

$$\text{Mass (lb) of copper} = (5.01 \text{ lb Covellite}) \left(\frac{66\%}{100\%}\right) = 3.3066 \text{ lb copper}$$

$$\text{Mass (g) of copper} = (3.3066 \text{ lb}) \left(\frac{1 \text{ kg}}{2.205 \text{ lb}}\right) \left(\frac{1000 \text{ g}}{1 \text{ kg}}\right) = 1.49959 \times 10^3 \text{ g}$$

$$\text{Volume (cm}^3\text{) of copper} = (1.49959 \times 10^3 \text{ g Cu}) \left(\frac{\text{cm}^3 \text{ Cu}}{8.95 \text{ g Cu}}\right) = 167.552 \text{ cm}^3 \text{ Cu}$$

$$V = \pi r^2 h$$

$$\text{Radius (cm)} = \left(\frac{6.304 \times 10^{-3} \text{ in}}{2}\right) \left(\frac{2.54 \text{ cm}}{1 \text{ in}}\right) = 8.00608 \times 10^{-3} \text{ cm}$$

$$\text{Height (length) in cm} = \frac{V}{\pi r^2} = \frac{167.552 \text{ cm}^3}{(\pi)(8.00608 \times 10^{-3} \text{ cm})^2} = 8.3207 \times 10^5 \text{ cm}$$

$$\text{Length (m)} = (8.3207 \times 10^5 \text{ cm}) \left(\frac{10^{-2} \text{ m}}{1 \text{ cm}}\right) = 8.3207 \times 10^3 = \mathbf{8.32 \times 10^3 \text{ m}}$$

- 1.41 Plan: The liquid with the larger density will occupy the bottom of the beaker, while the liquid with the smaller density volume will be on top of the more dense liquid.

Solution:

a) Liquid A is more dense than water; liquids B and C are less dense than water.

b) Density of liquid B could be **0.94 g/mL**. Liquid B is more dense than C so its density must be greater than 0.88 g/mL. Liquid B is less dense than water so its density must be less than 1.0 g/mL.

- 1.42 An exact number is defined to have a certain value (exactly). There is no uncertainty in an exact number. An exact number is considered to have an infinite number of significant figures and, therefore, does not limit the digits in the calculation.

- 1.43 Plan: Review the rules for significant figures.

Solution:

Initial or leading zeros are never significant; internal zeros (occurring between nonzero digits) are always significant; terminal zeros to the right of a decimal point are significant; terminal zeros to the left of a decimal point are significant **only** if they were measured.

- 1.44 Plan: Review the rules for significant zeros.

Solution:

a) No significant zeros (leading zeros are not significant)

b) No significant zeros (leading zeros are not significant)

- c) 0.0410 (terminal zeros to the right of the decimal point are significant)  
 d)  $4.0100 \times 10^4$  (zeros between nonzero digits are significant; terminal zeros to the right of the decimal point are significant)

1.45 Plan: Review the rules for significant zeros.

Solution:

- a) 5.08 (zeros between nonzero digits are significant)  
 b) 508 (zeros between nonzero digits are significant)  
 c)  $5.080 \times 10^3$  (zeros between nonzero digits are significant; terminal zeros to the right of the decimal point are significant)  
 d) 0.05080 (leading zeros are not significant; zeros between nonzero digits are significant; terminal zeros to the right of the decimal point are significant)

1.46 Plan: Use a calculator to obtain an initial value. Use the rules for significant figures and rounding to get the final answer.

Solution:

- a)  $\frac{(2.795 \text{ m})(3.10 \text{ m})}{6.48 \text{ m}} = 1.3371 = \mathbf{1.34 \text{ m}}$  (maximum of 3 significant figures allowed since two of the original numbers in the calculation have only 3 significant figures)

b)  $V = \left(\frac{4}{3}\right) \pi (17.282 \text{ mm})^3 = 21,620.74 = \mathbf{21,621 \text{ mm}^3}$  (maximum of 5 significant figures allowed)

- c)  $1.110 \text{ cm} + 17.3 \text{ cm} + 108.2 \text{ cm} + 316 \text{ cm} = 442.61 = \mathbf{443 \text{ cm}}$  (no digits allowed to the right of the decimal since 316 has no digits to the right of the decimal point)

1.47 Plan: Use a calculator to obtain an initial value. Use the rules for significant figures and rounding to get the final answer.

Solution:

- a)  $\frac{2.420 \text{ g} + 15.6 \text{ g}}{4.8 \text{ g}} = 3.7542 = \mathbf{3.8}$  (maximum of 2 significant figures allowed since one of the original numbers in the calculation has only 2 significant figures)

b)  $\frac{7.87 \text{ mL}}{16.1 \text{ mL} - 8.44 \text{ mL}} = 1.0274 = \mathbf{1.0}$  (After the subtraction, the denominator has 2 significant figures; only one digit is allowed to the right of the decimal in the value in the denominator since 16.1 has only one digit to the right of the decimal.)

- c)  $V = \pi (6.23 \text{ cm})^2 (4.630 \text{ cm}) = 564.556 = \mathbf{565 \text{ cm}^3}$  (maximum of 3 significant figures allowed since one of the original numbers in the calculation has only 3 significant figures)

1.48 Plan: Review the procedure for changing a number to scientific notation. There can be only 1 nonzero digit to the left of the decimal point in correct scientific notation. Moving the decimal point to the left results in a positive exponent while moving the decimal point to the right results in a negative exponent.

Solution:

- a)  $\mathbf{1.310000 \times 10^5}$  (Note that all zeros are significant.)  
 b)  $\mathbf{4.7 \times 10^{-4}}$  (No zeros are significant.)  
 c)  $\mathbf{2.10006 \times 10^5}$   
 d)  $\mathbf{2.1605 \times 10^3}$

1.49 Plan: Review the procedure for changing a number to scientific notation. There can be only 1 nonzero digit to the left of the decimal point in correct scientific notation. Moving the decimal point to the left results in a positive exponent while moving the decimal point to the right results in a negative exponent.

Solution:

- a)  $\mathbf{2.820 \times 10^2}$  (Note that the zero is significant.)  
 b)  $\mathbf{3.80 \times 10^{-2}}$  (Note the one significant zero.)

- c) **4.2708x10<sup>3</sup>**  
 d) **5.82009x10<sup>4</sup>**

1.50 Plan: Review the examples for changing a number from scientific notation to standard notation. If the exponent is positive, move the decimal back to the right; if the exponent is negative, move the decimal point back to the left.

Solution:

- a) **5550** (Do not use terminal decimal point since the zero is not significant.)  
 b) **10070.** (Use terminal decimal point since final zero is significant.)  
 c) **0.000000885**  
 d) **0.003004**

1.51 Plan: Review the examples for changing a number from scientific notation to standard notation. If the exponent is positive, move the decimal back to the right; if the exponent is negative, move the decimal point back to the left.

Solution:

- a) **6500.** (Use terminal decimal point since the final zero is significant.)  
 b) **0.0000346**  
 c) **750** (Do not use terminal decimal point since the zero is not significant.)  
 d) **188.56**

1.52 Plan: Calculate a temporary answer by simply entering the numbers into a calculator. Then you will need to round the value to the appropriate number of significant figures. Cancel units as you would cancel numbers, and place the remaining units after your numerical answer.

Solution:

$$a) \frac{(6.626 \times 10^{-34} \text{ J}\cdot\text{s})(2.9979 \times 10^8 \text{ m/s})}{489 \times 10^{-9} \text{ m}} = 4.062185 \times 10^{-19}$$

**4.06x10<sup>-19</sup> J** (489x10<sup>-9</sup> m limits the answer to 3 significant figures; units of m and s cancel)

$$b) \frac{(6.022 \times 10^{23} \text{ molecules/mol})(1.23 \times 10^2 \text{ g})}{46.07 \text{ g/mol}} = 1.6078 \times 10^{24}$$

**1.61x10<sup>24</sup> molecules** (1.23x10<sup>2</sup> g limits answer to 3 significant figures; units of mol and g cancel)

$$c) (6.022 \times 10^{23} \text{ atoms/mol}) \left( 2.18 \times 10^{-18} \text{ J/atom} \right) \left( \frac{1}{2^2} - \frac{1}{3^2} \right) = 1.82333 \times 10^5$$

**1.82x10<sup>5</sup> J/mol** (2.18x10<sup>-18</sup> J/atom limits answer to 3 significant figures; unit of atoms cancels)

1.53 Plan: Calculate a temporary answer by simply entering the numbers into a calculator. Then you will need to round the value to the appropriate number of significant figures. Cancel units as you would cancel numbers, and place the remaining units after your numerical answer.

Solution:

$$a) \frac{4.32 \times 10^7 \text{ g}}{\frac{4}{3} (3.1416) (1.95 \times 10^2 \text{ cm})^3} = 1.3909 = \mathbf{1.39 \text{ g/cm}^3}$$

(4.32x10<sup>7</sup> g limits the answer to 3 significant figures)

$$b) \frac{(1.84 \times 10^2 \text{ g})(44.7 \text{ m/s})^2}{2} = 1.8382 \times 10^5 = \mathbf{1.84 \times 10^5 \text{ g}\cdot\text{m}^2/\text{s}^2}$$

(1.84x10<sup>2</sup> g limits the answer to 3 significant figures)

$$c) \frac{(1.07 \times 10^{-4} \text{ mol / L})^2 (3.8 \times 10^{-3} \text{ mol / L})}{(8.35 \times 10^{-5} \text{ mol / L})(1.48 \times 10^{-2} \text{ mol / L})^3} = 0.16072 = \mathbf{0.16 \text{ L/mol}}$$

(3.8x10<sup>-3</sup> mol/L limits the answer to 2 significant figures; mol<sup>3</sup>/L<sup>3</sup> in the numerator cancels mol<sup>4</sup>/L<sup>4</sup> in the denominator to leave mol/L in the denominator or units of L/mol)

1.54 Plan: Exact numbers are those which have no uncertainty. Unit definitions and number counts of items in a group are examples of exact numbers.

Solution:

- The height of Angel Falls is a measured quantity. This is **not** an exact number.
- The number of planets in the solar system is a number count. This **is** an exact number.
- The number of grams in a pound is not a unit definition. This is **not** an exact number.
- The number of millimeters in a meter is a definition of the prefix “milli-.” This **is** an exact number.

1.55 Plan: Exact numbers are those which have no uncertainty. Unit definitions and number counts of items in a group are examples of exact numbers.

Solution:

- The speed of light is a measured quantity. It is **not** an exact number.
- The density of mercury is a measured quantity. It is **not** an exact number.
- The number of seconds in an hour is based on the definitions of minutes and hours. This **is** an exact number.
- The number of states is a counted value. This **is** an exact number.

1.56 Plan: Observe the figure, and estimate a reading the best you can.

Solution:

The scale markings are 0.2 cm apart. The end of the metal strip falls between the mark for 7.4 cm and 7.6 cm. If we assume that one can divide the space between markings into fourths, the uncertainty is one-fourth the separation between the marks. Thus, since the end of the metal strip falls between 7.45 and 7.55 we can report its length as **7.50 ± 0.05 cm**. (Note: If the assumption is that one can divide the space between markings into halves only, then the result is 7.5 ± 0.1 cm.)

1.57 Plan: You are given the density values for five solvents. Use the mass and volume given to calculate the density of the solvent in the cleaner and compare that value to the density values given to identify the solvent. Use the uncertainties in the mass and volume to recalculate the density.

Solution:

a) Density (g/mL) =  $\frac{\text{mass}}{\text{volume}} = \frac{11.775 \text{ g}}{15.00 \text{ mL}} = 0.7850 \text{ g/mL}$ . The closest value is **isopropanol**.

b) Ethanol is denser than isopropanol. Recalculating the density using the maximum mass = (11.775 + 0.003) g with the minimum volume = (15.00 – 0.02) mL, gives

Density (g/mL) =  $\frac{\text{mass}}{\text{volume}} = \frac{11.778 \text{ g}}{14.98 \text{ mL}} = 0.7862 \text{ g/mL}$ . This result is still clearly not ethanol.

**Yes**, the equipment is precise enough.

1.58 Plan: Calculate the average of each data set. Remember that accuracy refers to how close a measurement is to the actual or true value while precision refers to how close multiple measurements are to each other.

Solution:

a)  $I_{\text{avg}} = \frac{8.72 \text{ g} + 8.74 \text{ g} + 8.70 \text{ g}}{3} = 8.7200 = \mathbf{8.72 \text{ g}}$

$II_{\text{avg}} = \frac{8.56 \text{ g} + 8.77 \text{ g} + 8.83 \text{ g}}{3} = 8.7200 = \mathbf{8.72 \text{ g}}$

$III_{\text{avg}} = \frac{8.50 \text{ g} + 8.48 \text{ g} + 8.51 \text{ g}}{3} = 8.4967 = \mathbf{8.50 \text{ g}}$

$IV_{\text{avg}} = \frac{8.41 \text{ g} + 8.72 \text{ g} + 8.55 \text{ g}}{3} = 8.5600 = \mathbf{8.56 \text{ g}}$

Sets **I** and **II** are most accurate since their average value, 8.72 g, is closest to the true value, 8.72 g.

b) To get an idea of precision, calculate the range of each set of values: largest value – smallest value. A small range is an indication of good precision since the values are close to each other.

$I_{\text{range}} = 8.74 \text{ g} - 8.70 \text{ g} = 0.04 \text{ g}$

$II_{\text{range}} = 8.83 \text{ g} - 8.56 \text{ g} = 0.27 \text{ g}$

$III_{\text{range}} = 8.51 \text{ g} - 8.48 \text{ g} = 0.03 \text{ g}$

$$IV_{\text{range}} = 8.72 \text{ g} - 8.41 \text{ g} = 0.31 \text{ g}$$

**Set III** is the most precise (smallest range), but is the least accurate (the average is the farthest from the actual value).

c) **Set I** has the best combination of high accuracy (average value = actual value) and high precision (relatively small range).

d) **Set IV** has both low accuracy (average value differs from actual value) and low precision (has the largest range).

- 1.59 Plan: Remember that accuracy refers to how close a measurement is to the actual or true value; since the bull's-eye represents the actual value, the darts that are closest to the bull's-eye are the most accurate. Precision refers to how close multiple measurements are to each other; darts that are positioned close to each other on the target have high precision.

Solution:

a) **Experiments II and IV** — the averages appear to be near each other.

b) **Experiments III and IV** — the darts are closely grouped.

c) **Experiment IV and perhaps Experiment II** — the average is in or near the bull's-eye.

d) **Experiment III** — the darts are close together, but not near the bull's-eye.

- 1.60 Plan: Convert volume in gal to volume in mL. Divide that volume by 500 to find the number of times the 500.-mL cylinder would be used. Divide the remaining volume by 50 to find the number of times the 50.-mL cylinder would be used; divide the remaining volume by 5 to find the number of times the 5-mL cylinder would be used.

Solution:

$$\text{Volume (mL)} = (2.000 \text{ gal}) \left( \frac{4 \text{ qt}}{1 \text{ gal}} \right) \left( \frac{1 \text{ L}}{1.057 \text{ qt}} \right) \left( \frac{1 \text{ mL}}{10^{-3} \text{ L}} \right) = 7.56859 \times 10^3 \text{ mL}$$

$$\frac{7.56859 \times 10^3 \text{ mL}}{5.00 \times 10^2 \text{ mL}} = 15.137$$

So, use the 500 mL graduated cylinder 15 times to measure  $(15 \times 500 \text{ mL}) = 7500 \text{ mL}$ .

$$7568.59 \text{ mL} - 7500 \text{ mL} = 68.59 \text{ mL}$$

Use the 50 mL graduated cylinder once to measure 50 mL for a total of 7550 mL.

$$7568.59 \text{ mL} - 7550 \text{ mL} = 18.59 \text{ mL}$$

Use the 5 mL graduated cylinder four times to measure 18.59 mL for a total of 7568.59 mL.

- 1.61 Plan: If it is necessary to force something to happen, the potential energy will be higher.

Solution:

a)

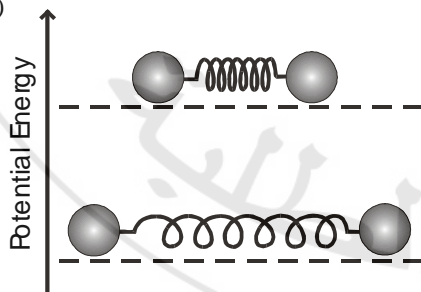

b)

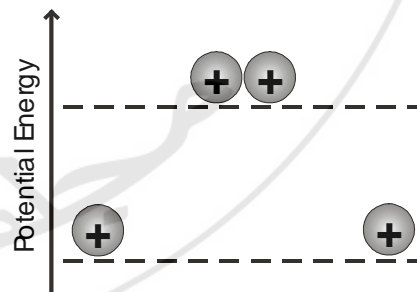

a) The balls on the relaxed spring have a lower potential energy and are more stable. The balls on the compressed spring have a higher potential energy, because the balls will move once the spring is released. This configuration is less stable.

b) The two + charges apart from each other have a lower potential energy and are more stable. The two + charges near each other have a higher potential energy, because they repel one another. This arrangement is less stable.

- 1.62 Plan: In part a, convert volume in oz to  $\text{cm}^3$  and use the density to find the mass of that volume. In part b, find the volume of one dime in  $\text{cm}^3$ , and use the density to find the mass of that volume.

Solution:

$$\text{a) Mass} = (12 \text{ oz}) \left( \frac{29.57 \text{ cm}^3}{1 \text{ fl. oz}} \right) \left( \frac{1.0 \text{ g}}{\text{cm}^3} \right) = 3.5484 \times 10^2 = \mathbf{3.5 \times 10^2 \text{ g}}$$

$$\text{b) Mass} = \left( \frac{1 \text{ cm}^3}{5 \text{ dimes}} \right) \left( \frac{9.5 \text{ g}}{\text{cm}^3} \right) = 1.9 = \mathbf{2 \text{ g/dime}}$$

(This is limited to one significant figure because of the approximate volume of  $1 \text{ cm}^3$ .)

- 1.63 Plan: A physical change is one in which the physical form (or state) of a substance, but not its composition, is altered. A chemical change is one in which a substance is converted into a different substance with different composition and properties.

Solution:

a) Bonds have been broken in three yellow diatomic molecules. Bonds have been broken in three red diatomic molecules. The six resulting yellow atoms have reacted with three of the red atoms to form three molecules of a new substance. The remaining three red atoms have reacted with three blue atoms to form a new diatomic substance.

b) There has been one physical change as the blue atoms at 273 K in the liquid phase are now in the gas phase at 473 K.

- 1.64 Plan: Determine the volume of the room in cubic feet, using length x width x height = volume. Next, use the conversions from the inside back cover to convert the volume to liters. Finally, use the air conditioner's rate of exchange to determine the time required.

Solution:

$$V_{\text{air}} = V_{\text{room}} = 11 \text{ ft} \times 12 \text{ ft} \times 8.5 \text{ ft} = 1.122 \times 10^3 \text{ ft}^3$$

Conversion from  $\text{ft}^3$  to L:  $(1 \text{ ft})^3 = (12 \text{ inches})^3$ ;  $(1 \text{ inch})^3 = (2.54 \text{ cm})^3$ ;  $1 \text{ cm}^3 = 1 \text{ mL}$ ;  $1000 \text{ mL} = 1 \text{ L}$

$$\text{Volume (L)} = \left( 1.122 \times 10^3 \text{ ft}^3 \right) \left( \frac{12 \text{ in}}{1 \text{ ft}} \right)^3 \left( \frac{2.54 \text{ cm}}{1 \text{ in}} \right)^3 \left( \frac{1 \text{ mL}}{1 \text{ cm}^3} \right) \left( \frac{10^{-3} \text{ L}}{1 \text{ mL}} \right) = 3.17715 \times 10^4 \text{ L}$$

At a rate of 1200L/min, how many minutes will it take to replace all the air in the room?

$$\left( 3.17715 \times 10^4 \text{ L} \right) \left( \frac{1 \text{ min}}{1200 \text{ L}} \right) = 26.476 = \mathbf{26 \text{ minutes}}$$

Note: additional significant figures were kept in the calculation until the final step.

- 1.65 Plan: Take 90% of the mass of the coin to find the mass of gold in the coin in g; convert mass in g to mass in troy oz and use the price information to find the value of the gold. In part b, convert the mass of gold in troy oz to mass in g; multiply that mass by a factor of 100/90 since the coin is 90% gold. Divide the resulting mass by the mass of one coin to determine the number of coins with that total mass. In part c, convert the volume of gold from  $\text{in}^3$  to  $\text{cm}^3$  and use the given density to convert volume to mass in g. Multiply that mass by a factor of 100/90 since the coin is 90% gold. Divide the resulting mass by the mass of one coin to determine the number of coins with that total mass.

Solution:

$$\text{a) } (33.436 \text{ g}) \left( \frac{90.0\%}{100.0\%} \right) \left( \frac{1 \text{ tr. oz}}{31.1 \text{ g}} \right) \left( \frac{\$20.00}{1 \text{ tr. oz}} \right) = 19.3520 = \mathbf{\$19.4 \text{ before price increase.}}$$

$$(33.436 \text{ g}) \left( \frac{90.0\%}{100.0\%} \right) \left( \frac{1 \text{ tr. oz}}{31.1 \text{ g}} \right) \left( \frac{\$35.00}{1 \text{ tr. oz}} \right) = 33.8660 = \mathbf{\$33.9 \text{ after price increase.}}$$

$$\text{b) } (50.0 \text{ tr. oz}) \left( \frac{31.1 \text{ g}}{1 \text{ tr. oz}} \right) \left( \frac{100.0\%}{90.0\%} \right) \left( \frac{1 \text{ coin}}{33.436 \text{ g}} \right) = 51.674 = \mathbf{51.7 \text{ coins}}$$

$$c) (2.00 \text{ in}^3) \left( \frac{(2.54 \text{ cm})^3}{1 \text{ in}^3} \right) \left( \frac{19.3 \text{ g}}{1 \text{ cm}^3} \right) \left( \frac{100.0\%}{90.0\%} \right) \left( \frac{1 \text{ coin}}{33.436 \text{ g}} \right) = 21.0199 = \mathbf{21.0 \text{ coins}}$$

1.66 Plan: Use the concentrations of bromine given.

Solution:

$$\frac{\text{mass bromine in Dead Sea}}{\text{mass bromine in seawater}} = \frac{0.50 \text{ g/L}}{0.065 \text{ g/L}} = \mathbf{7.7 / 1}$$

1.67 Plan: The swimming pool is a rectangle so the volume of the water can be calculated by multiplying the three dimensions of length, width, and the depth of the water in the pool. The depth in ft must be converted to units of m before calculating the volume. The volume in m<sup>3</sup> is then converted to volume in gal. The density of water is used to find the mass of this volume of water.

Solution:

$$a) \text{Depth of water (m)} = (4.8 \text{ ft}) \left( \frac{12 \text{ in}}{1 \text{ ft}} \right) \left( \frac{2.54 \text{ cm}}{1 \text{ in}} \right) \left( \frac{10^{-2} \text{ m}}{1 \text{ cm}} \right) = 1.46304 \text{ m}$$

$$\text{Volume (m}^3) = \text{length} \times \text{width} \times \text{depth} = (50.0 \text{ m})(25.0 \text{ m})(1.46304 \text{ m}) = 1828.8 \text{ m}^3$$

$$\text{Volume (gal)} = (1828.8 \text{ m}^3) \left( \frac{10^3 \text{ L}}{1 \text{ m}^3} \right) \left( \frac{1.057 \text{ qt}}{1 \text{ L}} \right) \left( \frac{1 \text{ gal}}{4 \text{ qt}} \right) = 4.8326 \times 10^5 = \mathbf{4.8 \times 10^5 \text{ gal}}$$

b) Using the density of water = 1.0 g/mL.

$$\text{Mass (kg)} = (4.8326 \times 10^5 \text{ gal}) \left( \frac{4 \text{ qt}}{1 \text{ gal}} \right) \left( \frac{1000 \text{ mL}}{1.057 \text{ qt}} \right) \left( \frac{1.0 \text{ g}}{\text{mL}} \right) \left( \frac{1 \text{ kg}}{1000 \text{ g}} \right) = 1.8288 \times 10^6 = \mathbf{1.8 \times 10^6 \text{ kg}}$$

1.68 Plan: In each case, calculate the overall density of the ball and contents and compare to the density of air. The volume of the ball in cm<sup>3</sup> is converted to units of L to find the density of the ball itself in g/L. The densities of the ball and the gas in the ball are additive because the volume of the ball and the volume of the gas are the same.

Solution:

a) Density of evacuated ball: the mass is only that of the sphere itself:

$$\text{Volume of ball (L)} = (560 \text{ cm}^3) \left( \frac{1 \text{ mL}}{1 \text{ cm}^3} \right) \left( \frac{10^{-3} \text{ L}}{1 \text{ mL}} \right) = 0.560 = 0.56 \text{ L}$$

$$\text{Density of evacuated ball} = \frac{\text{mass}}{\text{volume}} = \frac{0.12 \text{ g}}{0.560} = 0.21 \text{ g/L}$$

The evacuated ball will **float** because its density is less than that of air.

b) Because the density of CO<sub>2</sub> is greater than that of air, a ball filled with CO<sub>2</sub> will **sink**.

c) Density of ball + density of hydrogen = 0.0899 + 0.21 g/L = 0.30 g/L

The ball will **float** because the density of the ball filled with hydrogen is less than the density of air.

d) Because the density of O<sub>2</sub> is greater than that of air, a ball filled with O<sub>2</sub> will **sink**.

e) Density of ball + density of nitrogen = 0.21 g/L + 1.165 g/L = 1.38 g/L

The ball will **sink** because the density of the ball filled with nitrogen is greater than the density of air.

$$f) \text{To sink, the total mass of the ball and gas must weigh} \left( \frac{0.560 \text{ L}}{1 \text{ L}} \right) \left( \frac{1.189 \text{ g}}{1 \text{ L}} \right) = 0.66584 \text{ g}$$

For the evacuated ball:

$$0.66584 - 0.12 \text{ g} = 0.54585 = \mathbf{0.55 \text{ g}}. \text{ More than 0.55 g would have to be added to make the ball sink.}$$

For ball filled with hydrogen:

$$\text{Mass of hydrogen in the ball} = (0.56 \text{ L}) \left( \frac{0.0899 \text{ g}}{1 \text{ L}} \right) = 0.0503 \text{ g}$$

$$\text{Mass of hydrogen and ball} = 0.0503 \text{ g} + 0.12 \text{ g} = 0.17 \text{ g}$$

$$0.66584 - 0.17 \text{ g} = 0.4958 = \mathbf{0.50 \text{ g}}. \text{ More than 0.50 g would have to be added to make the ball sink.}$$

- 1.69 Plan: Convert the cross-sectional area of  $1.0 \mu\text{m}^2$  to  $\text{mm}^2$  and then use the tensile strength of grunerite to find the mass that can be held up by a strand of grunerite with that cross-sectional area. Calculate the area of aluminum and steel that can match that mass.

Solution:

$$\text{Cross-sectional area (mm}^2\text{)} = (1.0 \mu\text{m}^2) \left( \frac{(1 \times 10^{-6} \text{ m})^2}{(1 \mu\text{m})^2} \right) \left( \frac{(1 \text{ mm})^2}{(1 \times 10^{-3} \text{ m})^2} \right) = 1.0 \times 10^{-6} \text{ mm}^2$$

Calculate the mass that can be held up by grunerite with a cross-sectional area of  $1.0 \times 10^{-6} \text{ mm}^2$ :

$$(1 \times 10^{-6} \text{ mm}^2) \left( \frac{3.5 \times 10^2 \text{ kg}}{1 \text{ mm}^2} \right) = 3.5 \times 10^{-4} \text{ kg}$$

Calculate the area of aluminum required to match a mass of  $3.5 \times 10^{-4} \text{ kg}$ :

$$(3.5 \times 10^{-4} \text{ kg}) \left( \frac{2.205 \text{ lb}}{1 \text{ kg}} \right) \left( \frac{1 \text{ in}^2}{2.5 \times 10^4 \text{ lb}} \right) \left( \frac{(2.54 \text{ cm})^2}{(1 \text{ in})^2} \right) \left( \frac{(10 \text{ mm})^2}{(1 \text{ cm})^2} \right) = 1.9916 \times 10^{-5} = \mathbf{2.0 \times 10^{-5} \text{ mm}^2}$$

Calculate the area of steel required to match a mass of  $3.5 \times 10^{-4} \text{ kg}$ :

$$(3.5 \times 10^{-4} \text{ kg}) \left( \frac{2.205 \text{ lb}}{1 \text{ kg}} \right) \left( \frac{1 \text{ in}^2}{5.0 \times 10^4 \text{ lb}} \right) \left( \frac{(2.54 \text{ cm})^2}{(1 \text{ in})^2} \right) \left( \frac{(10 \text{ mm})^2}{(1 \text{ cm})^2} \right) = 9.9580 \times 10^{-6} = \mathbf{1.0 \times 10^{-5} \text{ mm}^2}$$

- 1.70 Plan: To determine if the crown is made of pure gold, the density of the crown must be calculated from its mass and volume. Convert the mass of the crown to g before dividing by the volume to obtain density.

Solution:

$$\text{Mass (oz)} = 4 \text{ lb} \left( \frac{16 \text{ oz}}{1 \text{ lb}} \right) + 13 \text{ oz} = 77 \text{ oz}$$

$$\text{Mass (g)} = (77 \text{ oz}) \left( \frac{1 \text{ lb}}{16 \text{ oz}} \right) \left( \frac{1 \text{ kg}}{2.205 \text{ lb}} \right) \left( \frac{1000 \text{ g}}{1 \text{ kg}} \right) = 2182.539683 \text{ g}$$

$$\text{Density (g/cm}^3\text{)} = \frac{(2182.539683 \text{ g})}{(186 \text{ mL}) \left( \frac{1 \text{ cm}^3}{1 \text{ mL}} \right)} = 11.734 = 12 \text{ g/cm}^3$$

The crown is not pure gold because its density is not the same as the density of gold.

- 1.71 Plan: Convert the surface area to  $\text{m}^2$  and then use the surface area and the depth to determine the volume of the oceans (area  $\times$  depth = volume) in  $\text{m}^3$ . The volume is then converted to liters, and finally to the mass of gold using the density of gold in  $\text{g/L}$ . Once the mass of the gold is known, its density is used to find the volume of that amount of gold. The mass of gold is converted to troy oz and the price of gold per troy oz gives the total price.

Solution:

$$\text{a) Area of ocean (m}^2\text{)} = (3.63 \times 10^8 \text{ km}^2) \left( \frac{(1000 \text{ m})^2}{(1 \text{ km})^2} \right) = 3.63 \times 10^{14} \text{ m}^2$$

$$\text{Volume of ocean (m}^3\text{)} = (\text{area})(\text{depth}) = (3.63 \times 10^{14} \text{ m}^2)(3800 \text{ m}) = 1.3794 \times 10^{18} \text{ m}^3$$

$$\text{Mass of gold (g)} = (1.3794 \times 10^{18} \text{ m}^3) \left( \frac{1 \text{ L}}{10^{-3} \text{ m}^3} \right) \left( \frac{5.8 \times 10^{-9} \text{ g}}{\text{L}} \right) = 8.00052 \times 10^{12} = \mathbf{8.0 \times 10^{12} \text{ g}}$$

b) Use the density of gold to convert mass of gold to volume of gold:

$$\text{Volume of gold (m}^3\text{)} = (8.00052 \times 10^{12} \text{ g}) \left( \frac{1 \text{ cm}^3}{19.3 \text{ g}} \right) \left( \frac{(0.01 \text{ m})^3}{(1 \text{ cm})^3} \right) = 4.14535 \times 10^5 = \mathbf{4.1 \times 10^5 \text{ m}^3}$$



$$c) \text{ Value of gold} = (8.00052 \times 10^{12} \text{ g}) \left( \frac{1 \text{ tr. oz.}}{31.1 \text{ g}} \right) \left( \frac{\$370.00}{1 \text{ tr. oz.}} \right) = 9.51830 \times 10^{13} = \mathbf{\$9.5 \times 10^{13}}$$

1.72 Plan: In part a, convert mass of aluminum in metric tons to lbs. In part b, convert the mass of aluminum to mass in g and use the density to convert mass to volume in  $\text{cm}^3$ , which is then converted to volume in  $\text{ft}^3$ .

Solution:

$$a) (35.1 \times 10^6 \text{ t}) \left( \frac{1000 \text{ kg}}{1 \text{ t}} \right) \left( \frac{2.205 \text{ lbs}}{1 \text{ kg}} \right) = 7.73955 \times 10^{10} = \mathbf{7.74 \times 10^{10} \text{ lbs}}$$

$$b) (35.1 \times 10^6 \text{ t}) \left( \frac{1000 \text{ kg}}{1 \text{ t}} \right) \left( \frac{1000 \text{ g}}{1 \text{ kg}} \right) \left( \frac{\text{cm}^3}{2.70 \text{ g}} \right) \left( \frac{1 \text{ in}}{2.54 \text{ cm}} \right)^3 \left( \frac{1 \text{ ft}}{12 \text{ in}} \right)^3 = 4.590907 \times 10^8 = \mathbf{4.59 \times 10^8 \text{ ft}^3}$$

1.73 Plan: Use the equations for temperature conversion given in the chapter. The mass of nitrogen is conserved when the gas is liquefied; the mass of the nitrogen gas equals the mass of the liquid nitrogen. Use the density of nitrogen gas to find the mass of the nitrogen; then use the density of liquid nitrogen to find the volume of that mass of liquid nitrogen.

Solution:

$$a) T (\text{in } ^\circ\text{C}) = T (\text{in K}) - 273.15 = 77.36 \text{ K} - 273.15 = \mathbf{-195.79^\circ\text{C}}$$

$$b) T (\text{in } ^\circ\text{F}) = \frac{9}{5} T (\text{in } ^\circ\text{C}) + 32 = \frac{9}{5} (-195.79^\circ\text{C}) + 32 = -320.422 = \mathbf{-320.42^\circ\text{F}}$$

$$c) \text{ Mass of liquid nitrogen} = \text{mass of gaseous nitrogen} = (895.0 \text{ L}) \left( \frac{4.566 \text{ g}}{1 \text{ L}} \right) = 4086.57 \text{ g N}_2$$

$$\text{Volume of liquid N}_2 = (4086.57 \text{ g}) \left( \frac{1 \text{ L}}{809 \text{ g}} \right) = 5.0514 = \mathbf{5.05 \text{ L}}$$

1.74 Plan: Use conversion factors to convert cm to m and ft to m.

Solution:

$$\text{rubber: speed (m/s)} = \left( \frac{5.4 \times 10^3 \text{ cm}}{1 \text{ s}} \right) \left( \frac{10^{-2} \text{ m}}{1 \text{ cm}} \right) = \mathbf{54 \text{ m/s}}$$

$$\text{granite: speed (m/s)} = \left( \frac{1.97 \times 10^4 \text{ ft}}{1 \text{ s}} \right) \left( \frac{12 \text{ in}}{1 \text{ ft}} \right) \left( \frac{2.54 \text{ cm}}{1 \text{ in}} \right) \left( \frac{10^{-2} \text{ m}}{1 \text{ cm}} \right) = 6.004556 \times 10^3 = \mathbf{6.00 \times 10^3 \text{ m/s}}$$

1.75 Plan: Convert the time in hr to min and multiply that time by the number of raindrops that fall each minute to determine the total number of raindrops. Multiply the number of raindrops by the mass of one raindrop and convert that mass to kg.

Solution:

$$1.5 \text{ h} \left( \frac{60 \text{ min}}{1 \text{ h}} \right) \left( \frac{5.1 \times 10^5 \text{ raindrops}}{\text{min}} \right) \left( \frac{0.52 \text{ mg}}{\text{raindrop}} \right) \left( \frac{10^{-3} \text{ g}}{1 \text{ mg}} \right) \left( \frac{1 \text{ kg}}{1000 \text{ g}} \right) = 23.868 = \mathbf{24 \text{ kg}}$$

1.76 Plan: Determine the volume of a particle (using the equation for the volume of a sphere), and then convert the volume to  $\text{cm}^3$ . Use the density and volume of the particle to determine the mass of a particle. Find the volume of the room; multiply the room volume by 50.  $\mu\text{g}$  to find the total mass of particles in the room. Divide the total mass of particles by the mass of one particle to determine the number of particles in the room. Determine the mass of particles in each breath and divide by the mass of one particle to determine the number of particles in each breath.

Solution:

$$\text{Volume } (\mu\text{m}^3) \text{ of one particle} = \left( \frac{4}{3} \right) \pi r^3 = \left( \frac{4}{3} \right) \pi \left( \frac{2.5 \mu\text{m}}{2} \right)^3 = 8.1812 = \mathbf{8.2 \mu\text{m}^3}$$

$$\text{Volume (cm}^3\text{) of one particle} = 8.1812 \mu\text{m}^3 \left( \frac{(1 \text{ cm})^3}{(10^4 \mu\text{m})^3} \right) = 8.1812 \times 10^{-12} \text{ cm}^3$$

$$\text{Mass (g) of one particle} = 8.1812 \times 10^{-12} \text{ cm}^3 \left( \frac{2.5 \text{ g}}{\text{cm}^3} \right) = 2.045 \times 10^{-11} = 2.0 \times 10^{-11} \text{ g each microparticle}$$

Calculate the volume of the room in  $\text{m}^3$ :

$$\text{Volume}_{\text{room}} (\text{ft}^3) = 10.0 \text{ ft} \times 8.25 \text{ ft} \times 12.5 \text{ ft} = 1.031 \times 10^3 \text{ ft}^3$$

$$\text{Volume}_{\text{room}} (\text{m}^3) = (1.031 \times 10^3 \text{ ft}^3) \left( \frac{(12 \text{ in})^3}{(1 \text{ ft})^3} \right) \left( \frac{(2.54 \text{ cm})^3}{(1 \text{ in})^3} \right) \left( \frac{(10^{-2} \text{ m})^3}{(1 \text{ cm})^3} \right) = 2.9195 \times 10^1 \text{ m}^3$$

$$\begin{aligned} \text{Total mass of particles (g)} &= (2.9195 \times 10^1 \text{ m}^3) \left( \frac{50. \mu\text{g}}{1 \text{ m}^3} \right) \left( \frac{10^{-6} \text{ g}}{1 \mu\text{g}} \right) \\ &= 1.460 \times 10^{-3} = 1.5 \times 10^{-3} \text{ g for all the microparticles in the room} \end{aligned}$$

$$\begin{aligned} \text{Number of microparticles in room} &= 1.460 \times 10^{-3} \text{ g} \left( \frac{1 \text{ microparticle}}{2.045 \times 10^{-11} \text{ g}} \right) \\ &= 7.1394 \times 10^7 = \mathbf{7.1 \times 10^7 \text{ microparticles in the room.}} \end{aligned}$$

$$\text{Mass (g) of particles in one breath} = 0.500 \text{ L} \left( \frac{10^{-3} \text{ m}^3}{1 \text{ L}} \right) \left( \frac{50 \mu\text{g}}{\text{m}^3} \right) \left( \frac{10^{-6} \text{ g}}{1 \mu\text{g}} \right) = 2.5 \times 10^{-8} \text{ g in one 0.500 L breath}$$

$$\begin{aligned} \text{Number of microparticles in one breath} &= (2.5 \times 10^{-8} \text{ g}) \left( \frac{1 \text{ microparticle}}{2.045 \times 10^{-11} \text{ g}} \right) \\ &= 1.222 \times 10^3 = \mathbf{1.2 \times 10^3 \text{ microparticles in a breath.}} \end{aligned}$$

- 1.77 **Plan:** A physical change is one in which the physical form (or state) of a substance, but not its composition, is altered. A chemical change is one in which a substance is converted into a different substance with different composition and properties. A physical property is a characteristic shown by a substance itself, without interacting with or changing into other substances. A chemical property is a characteristic of a substance that appears as it interacts with, or transforms into, other substances.

**Solution:**

- Scene A** shows a physical change. The substance changes from a solid to a gas but a new substance is not formed.
- Scene B** shows a chemical change. Two diatomic elements form from a diatomic compound.
- Both **Scenes A and B** result in different physical properties. Physical and chemical changes result in different physical properties.
- Scene B** is a chemical change; therefore, it results in different chemical properties.
- Scene A** results in a change in state. The substance changes from a solid to a gas.

- 1.78 **Plan:** Determine the total mass of Earth's crust in metric tons (t) by finding the volume of crust (surface area  $\times$  depth) in  $\text{km}^3$  and then in  $\text{cm}^3$  and then using the density to find the mass of this volume, using conversions from the inside back cover. The mass of each individual element comes from the concentration of that element multiplied by the mass of the crust.

**Solution:**

$$\text{Volume of crust (km}^3\text{)} = \text{area} \times \text{depth} = (35 \text{ km}) (5.10 \times 10^8 \text{ km}^2) = 1.785 \times 10^{10} \text{ km}^3$$

$$\text{Volume of crust (cm}^3\text{)} = (1.785 \times 10^{10} \text{ km}^3) \left( \frac{(1000 \text{ m})^3}{(1 \text{ km})^3} \right) \left( \frac{(1 \text{ cm})^3}{(0.01 \text{ m})^3} \right) = 1.785 \times 10^{25} \text{ cm}^3$$

$$\text{Mass of crust (t)} = (1.785 \times 10^{25} \text{ cm}^3) \left( \frac{2.8 \text{ g}}{1 \text{ cm}^3} \right) \left( \frac{1 \text{ kg}}{1000 \text{ g}} \right) \left( \frac{1 \text{ t}}{1000 \text{ kg}} \right) = 4.998 \times 10^{19} \text{ t}$$

$$\text{Mass of oxygen (g)} = (4.998 \times 10^{19} \text{ t}) \left( \frac{4.55 \times 10^5 \text{ g oxygen}}{1 \text{ t}} \right) = 2.2741 \times 10^{25} = \mathbf{2.3 \times 10^{25} \text{ g oxygen}}$$

$$\text{Mass of silicon (g)} = (4.998 \times 10^{19} \text{ t}) \left( \frac{2.72 \times 10^5 \text{ g silicon}}{1 \text{ t}} \right) = 1.3595 \times 10^{25} = \mathbf{1.4 \times 10^{25} \text{ g silicon}}$$

$$\begin{aligned} \text{Mass of ruthenium} = \text{mass of rhodium} &= (4.998 \times 10^{19} \text{ t}) \left( \frac{1 \times 10^{-4} \text{ g element}}{1 \text{ t}} \right) \\ &= 4.998 \times 10^{15} = \mathbf{5 \times 10^{15} \text{ g each of ruthenium and rhodium}} \end{aligned}$$

- 1.79 Viscosity would increase from gas to liquid to solid. In the solid state, the submicroscopic particles are located at fixed positions because of the strong forces between them, and this greatly restrains their movement. In the liquid state, the forces are weaker, and, in the gaseous state, the forces between the particles are essentially nonexistent, allowing them to move freely past one another.

- 1.80 Plan: In visualizing the problem, the two scales can be set next to each other.

Solution:

There are 50 divisions between the freezing point and boiling point of benzene on the °X scale and 74.6 divisions

$$(80.1^\circ\text{C} - 5.5^\circ\text{C}) \text{ on the } ^\circ\text{C} \text{ scale. So } ^\circ\text{X} = \left( \frac{50^\circ\text{X}}{74.6^\circ\text{C}} \right) ^\circ\text{C}$$

This does not account for the offset of 5.5 divisions in the °C scale from the zero point on the °X scale.

$$\text{So } ^\circ\text{X} = \left( \frac{50^\circ\text{X}}{74.6^\circ\text{C}} \right) (^\circ\text{C} - 5.5^\circ\text{C})$$

Check: Plug in 80.1°C and see if result agrees with expected value of 50°X.

$$\text{So } ^\circ\text{X} = \left( \frac{50^\circ\text{X}}{74.6^\circ\text{C}} \right) (80.1^\circ\text{C} - 5.5^\circ\text{C}) = 50^\circ\text{X}$$

Use this formula to find the freezing and boiling points of water on the °X scale.

$$\text{Freezing point}_{\text{water}} (^\circ\text{X}) = \left( \frac{50^\circ\text{X}}{74.6^\circ\text{C}} \right) (0.00^\circ\text{C} - 5.5^\circ\text{C}) = 3.68^\circ\text{X} = \mathbf{-3.7^\circ\text{X}}$$

$$\text{Boiling point}_{\text{water}} (^\circ\text{X}) = \left( \frac{50^\circ\text{X}}{74.6^\circ\text{C}} \right) (100.0^\circ\text{C} - 5.5^\circ\text{C}) = \mathbf{63.3^\circ\text{X}}$$

# CHAPTER 2 THE COMPONENTS OF MATTER

## END-OF-CHAPTER PROBLEMS

- 2.1 Plan: Refer to the definitions of an element and a compound.  
Solution:  
Unlike compounds, elements cannot be broken down by chemical changes into simpler materials. Compounds contain different types of atoms; there is only one type of atom in an element.
- 2.2 Plan: Refer to the definitions of a compound and a mixture.  
Solution:  
1) A compound has constant composition but a mixture has variable composition. 2) A compound has distinctly different properties than its component elements; the components in a mixture retain their individual properties.
- 2.3 Plan: Recall that a substance has a fixed composition.  
Solution:  
a) The fixed mass ratio means it has constant composition, thus, it is a **pure substance** (compound).  
b) All the atoms are identical, thus, it is a **pure substance** (element).  
c) The composition can vary, thus, this is an **impure substance** (a mixture).  
d) The specific arrangement of different atoms means it has constant composition, thus, it is a **pure substance** (compound).
- 2.4 Plan: Remember that an element contains only one kind of atom while a compound contains at least two different elements (two kinds of atoms) in a fixed ratio. A mixture contains at least two different substances in a composition that can vary.  
Solution:  
a) The presence of more than one element (calcium and chlorine) makes this pure substance a **compound**.  
b) There are only atoms from one element, sulfur, so this pure substance is an **element**.  
c) This is a combination of two compounds and has a varying composition, so this is a **mixture**.  
d) The presence of more than one type of atom means it cannot be an element. The specific, not variable, arrangement means it is a **compound**.
- 2.5 Plan: Recall that an element contains only one kind of atom; the atoms in an element may occur as molecules. A compound contains two kinds of atoms (different elements).  
Solution:  
a) This scene has 3 atoms of an element, 2 molecules of one compound (with one atom each of two different elements), and 2 molecules of a second compound (with 2 atoms of one element and one atom of a second element).  
b) This scene has 2 atoms of one element, 2 molecules of a diatomic element, and 2 molecules of a compound (with one atom each of two different elements).  
c) This scene has 2 molecules composed of 3 atoms of one element and 3 diatomic molecules of the same element.
- 2.6 Plan: Restate the three laws in your own words.  
Solution:  
a) The law of mass conservation applies to all substances — **elements, compounds, and mixtures**. Matter can neither be created nor destroyed, whether it is an element, compound, or mixture.  
b) The law of definite composition applies to **compounds** only, because it refers to a constant, or definite, composition of elements within a compound.  
c) The law of multiple proportions applies to **compounds** only, because it refers to the combination of elements to form compounds.

- 2.7 Plan: Review the three laws: law of mass conservation, law of definite composition, and law of multiple proportions.  
Solution:  
 a) **Law of Definite Composition** — The compound potassium chloride, KCl, is composed of the same elements and same fraction by mass, regardless of its source (Chile or Poland).  
 b) **Law of Mass Conservation** — The mass of the substances inside the flashbulb did not change during the chemical reaction (formation of magnesium oxide from magnesium and oxygen).  
 c) **Law of Multiple Proportions** — Two elements, O and As, can combine to form two different compounds that have different proportions of As present.
- 2.8 Plan: The law of multiple proportions states that two elements can form two different compounds in which the proportions of the elements are different.  
Solution:  
 Scene B illustrates the law of multiple proportions for compounds of chlorine and oxygen. The law of multiple proportions refers to the different compounds that two elements can form that have different proportions of the elements. Scene B shows that chlorine and oxygen can form both Cl<sub>2</sub>O, dichlorine monoxide, and ClO<sub>2</sub>, chlorine dioxide.
- 2.9 Plan: Review the definition of percent by mass.  
Solution:  
 a) **No**, the mass percent of each element in a compound is fixed. The percentage of Na in the compound NaCl is 39.34% (22.99 amu/58.44 amu), whether the sample is 0.5000 g or 50.00 g.  
 b) **Yes**, the mass of each element in a compound depends on the mass of the compound. A 0.5000 g sample of NaCl contains 0.1967 g of Na (39.34% of 0.5000 g), whereas a 50.00 g sample of NaCl contains 19.67 g of Na (39.34% of 50.00 g).
- 2.10 Generally no, the composition of a compound is determined by the elements used, not their amounts. If too much of one element is used, the excess will remain as unreacted element when the reaction is over.
- 2.11 Plan: Review the mass laws: law of mass conservation, law of definite composition, and law of multiple proportions. For each experiment, compare the mass values before and after each reaction and examine the ratios of the mass of white compound to the mass of colorless gas.  
Solution:  
 Experiment 1: mass before reaction = 1.00 g; mass after reaction = 0.64 g + 0.36 g = 1.00 g  
 Experiment 2: mass before reaction = 3.25 g; mass after reaction = 2.08 g + 1.17 g = 3.25 g  
 Both experiments demonstrate the **law of mass conservation** since the total mass before reaction equals the total mass after reaction.  
 Experiment 1: mass white compound/mass colorless gas = 0.64 g/0.36 g = 1.78  
 Experiment 2: mass white compound/mass colorless gas = 2.08 g/1.17 g = 1.78  
 Both Experiments 1 and 2 demonstrate the **law of definite composition** since the compound has the same composition by mass in each experiment.
- 2.12 Plan: Review the mass laws: law of mass conservation, law of definite composition, and law of multiple proportions. For each experiment, compare the mass values before and after each reaction and examine the ratios of the mass of reacted copper to the mass of reacted iodine.  
Solution:  
 Experiment 1: mass before reaction = 1.27 g + 3.50 g = 4.77 g; mass after reaction = 3.81 g + 0.96 g = 4.77 g  
 Experiment 2: mass before reaction = 2.55 g + 3.50 g = 6.05 g; mass after reaction = 5.25 g + 0.80 g = 6.05 g  
 Both experiments demonstrate the **law of mass conservation** since the total mass before reaction equals the total mass after reaction.  
 Experiment 1: mass of reacted copper = 1.27 g; mass of reacted iodine = 3.50 g – 0.96 g = 2.54 g  
 Mass reacted copper/mass reacted iodine = 1.27 g/2.54 g = 0.50  
 Experiment 2: mass of reacted copper = 2.55 g – 0.80 g = 1.75 g; mass of reacted iodine = 3.50 g  
 Mass reacted copper/mass reacted iodine = 1.75 g/3.50 g = 0.50  
 Both Experiments 1 and 2 demonstrate the **law of definite composition** since the compound has the same composition by mass in each experiment.

- 2.13 Plan: Fluorite is a mineral containing only calcium and fluorine. The difference between the mass of fluorite and the mass of calcium gives the mass of fluorine. Mass fraction is calculated by dividing the mass of element by the mass of compound (fluorite) and mass percent is obtained by multiplying the mass fraction by 100.

Solution:

a) Mass (g) of fluorine = mass of fluorite – mass of calcium = 2.76 g – 1.42 g = **1.34 g fluorine**

b) Mass fraction of Ca =  $\frac{\text{mass Ca}}{\text{mass fluorite}} = \frac{1.42 \text{ g Ca}}{2.76 \text{ g fluorite}} = 0.51449 = \mathbf{0.514}$

Mass fraction of F =  $\frac{\text{mass F}}{\text{mass fluorite}} = \frac{1.34 \text{ g F}}{2.76 \text{ g fluorite}} = 0.48551 = \mathbf{0.486}$

c) Mass percent of Ca = 0.51449 x 100 = 51.449 = **51.4%**

Mass percent of F = 0.48551 x 100 = 48.551 = **48.6%**

- 2.14 Plan: Galena is a mineral containing only lead and sulfur. The difference between the mass of galena and the mass of lead gives the mass of sulfur. Mass fraction is calculated by dividing the mass of element by the mass of compound (galena) and mass percent is obtained by multiplying the mass fraction by 100.

Solution:

a) Mass (g) of sulfur = mass of galena – mass of sulfur = 2.34 g – 2.03 g = **0.31 g sulfur**

b) Mass fraction of Pb =  $\frac{\text{mass Pb}}{\text{mass galena}} = \frac{2.03 \text{ g Pb}}{2.34 \text{ g galena}} = 0.8675214 = \mathbf{0.868}$

Mass fraction of S =  $\frac{\text{mass S}}{\text{mass galena}} = \frac{0.31 \text{ g S}}{2.34 \text{ g galena}} = 0.1324786 = \mathbf{0.13}$

c) Mass percent of Pb = (0.8675214)(100) = 86.752 = **86.8%**

Mass percent of S = (0.1324786)(100) = 13.248 = **13%**

- 2.15 Plan: Since copper is a metal and sulfur is a nonmetal, the sample contains 88.39 g Cu and 44.61 g S. Calculate the mass fraction of each element in the sample by dividing the mass of element by the total mass of compound. Multiply the mass of the second sample of compound in grams by the mass fraction of each element to find the mass of each element in that sample.

Solution:

Mass (g) of compound = 88.39 g copper + 44.61 g sulfur = 133.00 g compound

Mass fraction of copper =  $\left( \frac{88.39 \text{ g copper}}{133.00 \text{ g compound}} \right) = 0.664586$

Mass (g) of copper = (5264 kg compound)  $\left( \frac{10^3 \text{ g compound}}{1 \text{ kg compound}} \right) \left( \frac{0.664586 \text{ g copper}}{1 \text{ g compound}} \right)$   
 $= 3.49838 \times 10^6 = \mathbf{3.498 \times 10^6 \text{ g copper}}$

Mass fraction of sulfur =  $\left( \frac{44.61 \text{ g sulfur}}{133.00 \text{ g compound}} \right) = 0.335414$

Mass (g) of sulfur = (5264 kg compound)  $\left( \frac{10^3 \text{ g compound}}{1 \text{ kg compound}} \right) \left( \frac{0.335414 \text{ g sulfur}}{1 \text{ g compound}} \right)$   
 $= 1.76562 \times 10^6 = \mathbf{1.766 \times 10^6 \text{ g sulfur}}$

- 2.16 Plan: Since cesium is a metal and iodine is a nonmetal, the sample contains 63.94 g Cs and 61.06 g I. Calculate the mass fraction of each element in the sample by dividing the mass of element by the total mass of compound. Multiply the mass of the second sample of compound by the mass fraction of each element to find the mass of each element in that sample.

Solution:

Mass of compound = 63.94 g cesium + 61.06 g iodine = 125.00 g compound

Mass fraction of cesium =  $\left( \frac{63.94 \text{ g cesium}}{125.00 \text{ g compound}} \right) = 0.51152$

$$\text{Mass (g) of cesium} = (38.77 \text{ g compound}) \left( \frac{0.51152 \text{ g cesium}}{1 \text{ g compound}} \right) = 19.83163 = \mathbf{19.83 \text{ g cesium}}$$

$$\text{Mass fraction of iodine} = \left( \frac{61.06 \text{ g iodine}}{125.00 \text{ g compound}} \right) = 0.48848$$

$$\text{Mass (g) of iodine} = (38.77 \text{ g compound}) \left( \frac{0.48848 \text{ g iodine}}{1 \text{ g compound}} \right) = 18.9384 = \mathbf{18.94 \text{ g iodine}}$$

- 2.17 **Plan:** The law of multiple proportions states that if two elements form two different compounds, the relative amounts of the elements in the two compounds form a whole-number ratio. To illustrate the law we must calculate the mass of one element to one gram of the other element for each compound and then compare this mass for the two compounds. The law states that the ratio of the two masses should be a small whole-number ratio such as 1:2, 3:2, 4:3, etc.

**Solution:**

$$\text{Compound 1: } \frac{47.5 \text{ mass \% S}}{52.5 \text{ mass \% Cl}} = 0.90476 = 0.905$$

$$\text{Compound 2: } \frac{31.1 \text{ mass \% S}}{68.9 \text{ mass \% Cl}} = 0.451379 = 0.451$$

$$\text{Ratio: } \frac{0.905}{0.451} = 2.0067 = 2.00:1.00$$

Thus, the ratio of the mass of sulfur per gram of chlorine in the two compounds is a small whole-number ratio of 2:1, which agrees with the law of multiple proportions.

- 2.18 **Plan:** The law of multiple proportions states that if two elements form two different compounds, the relative amounts of the elements in the two compounds form a whole-number ratio. To illustrate the law we must calculate the mass of one element to one gram of the other element for each compound and then compare this mass for the two compounds. The law states that the ratio of the two masses should be a small whole-number ratio such as 1:2, 3:2, 4:3, etc.

**Solution:**

$$\text{Compound 1: } \frac{77.6 \text{ mass \% Xe}}{22.4 \text{ mass \% F}} = 3.4643 = 3.46$$

$$\text{Compound 2: } \frac{63.3 \text{ mass \% Xe}}{36.7 \text{ mass \% F}} = 1.7248 = 1.72$$

$$\text{Ratio: } \frac{3.46}{1.72} = 2.0116 = 2.01:1.00$$

Thus, the ratio of the mass of xenon per gram of fluorine in the two compounds is a small whole-number ratio of 2:1, which agrees with the law of multiple proportions.

- 2.19 **Plan:** Calculate the mass percent of calcium in dolomite by dividing the mass of calcium by the mass of the sample and multiply by 100. Compare this mass percent to that in fluorite. The compound with the larger mass percent of calcium is the richer source of calcium.

**Solution:**

$$\text{Mass percent calcium} = \frac{1.70 \text{ g calcium}}{7.81 \text{ g dolomite}} \times 100\% = 21.767 = \mathbf{21.8\% \text{ Ca}}$$

**Fluorite** (51.4%) is the richer source of calcium.

- 2.20 **Plan:** Determine the mass percent of sulfur in each sample by dividing the grams of sulfur in the sample by the total mass of the sample and multiplying by 100. The coal type with the smallest mass percent of sulfur has the smallest environmental impact.

Solution:

$$\text{Mass \% in Coal A} = \left( \frac{11.3 \text{ g sulfur}}{378 \text{ g sample}} \right) (100\%) = 2.9894 = 2.99\% \text{ S (by mass)}$$

$$\text{Mass \% in Coal B} = \left( \frac{19.0 \text{ g sulfur}}{495 \text{ g sample}} \right) (100\%) = 3.8384 = 3.84\% \text{ S (by mass)}$$

$$\text{Mass \% in Coal C} = \left( \frac{20.6 \text{ g sulfur}}{675 \text{ g sample}} \right) (100\%) = 3.0519 = 3.05\% \text{ S (by mass)}$$

**Coal A** has the smallest environmental impact.

- 2.21 Plan: This question is based on the law of definite composition. If the compound contains the same types of atoms, they should combine in the same way to give the same mass percentages of each of the elements.

Solution:

Potassium nitrate is a compound composed of three elements — potassium, nitrogen, and oxygen — in a specific ratio. If the ratio of these elements changed, then the compound would be changed to a different compound, for example, to potassium nitrite, with different physical and chemical properties. Dalton postulated that atoms of an element are identical, regardless of whether that element is found in India or Italy. Dalton also postulated that compounds result from the chemical combination of specific ratios of different elements. Thus, Dalton's theory explains why potassium nitrate, a compound comprised of three different elements in a specific ratio, has the same chemical composition regardless of where it is mined or how it is synthesized.

- 2.22 Plan: Review the discussion of the experiments in this chapter.

Solution:

Millikan determined the minimum *charge* on an oil drop and that the minimum charge was equal to the charge on one electron. Using Thomson's value for the *mass/charge ratio* of the electron and the determined value for the charge on one electron, Millikan calculated the mass of an electron ( $\text{charge}/(\text{charge}/\text{mass})$ ) to be  $9.109 \times 10^{-28}$  g.

- 2.23 Plan: The charges on the oil droplets should be whole-number multiples of a minimum charge. Determine that minimum charge by dividing the charges by small integers to find the common factor.

Solution:

$$-3.204 \times 10^{-19} \text{ C} / 2 = -1.602 \times 10^{-19} \text{ C}$$

$$-4.806 \times 10^{-19} \text{ C} / 3 = -1.602 \times 10^{-19} \text{ C}$$

$$-8.010 \times 10^{-19} \text{ C} / 5 = -1.602 \times 10^{-19} \text{ C}$$

$$-1.442 \times 10^{-18} \text{ C} / 4 = -1.602 \times 10^{-19} \text{ C}$$

The value  $-1.602 \times 10^{-19} \text{ C}$  is the common factor and is the charge for the electron.

- 2.24 Rutherford and co-workers expected that the alpha particles would pass through the foil essentially unaffected, or perhaps slightly deflected or slowed down. The observed results (most passing through straight, a few deflected, a very few at large angles) were partially consistent with expectations, but the large-angle scattering could not be explained by Thomson's model. The change was that Rutherford envisioned a small (but massive) positively charged nucleus in the atom, capable of deflecting the alpha particles as observed.

- 2.25 Plan: Recall that the mass number is the sum of protons and neutrons while the atomic number is the number of protons.

Solution:

Mass number (protons plus neutrons) – atomic number (protons) = **number of neutrons (c)**.

- 2.26 Plan: The superscript is the mass number, the sum of the number of protons and neutrons. Consult the periodic table to get the atomic number (the number of protons). The mass number – the number of protons = the number of neutrons. For atoms, the number of protons and electrons are equal.



Solution:

Isotope	Mass Number	# of Protons	# of Neutrons	# of Electrons
$^{36}\text{Ar}$	36	18	18	18
$^{38}\text{Ar}$	38	18	20	18
$^{40}\text{Ar}$	40	18	22	18

- 2.27 Plan: The superscript is the mass number, the sum of the number of protons and neutrons. Consult the periodic table to get the atomic number (the number of protons). The mass number – the number of protons = the number of neutrons. For atoms, the number of protons and electrons are equal.

Solution:

Isotope	Mass Number	# of Protons	# of Neutrons	# of Electrons
$^{35}\text{Cl}$	35	17	18	17
$^{37}\text{Cl}$	37	17	20	17

- 2.28 Plan: The superscript is the mass number ( $A$ ), the sum of the number of protons and neutrons; the subscript is the atomic number ( $Z$ , number of protons). The mass number – the number of protons = the number of neutrons. For atoms, the number of protons = the number of electrons.

Solution:

a)  $^{16}_8\text{O}$  and  $^{17}_8\text{O}$  have the **same number of protons and electrons** (8), but different numbers of neutrons.

$^{16}_8\text{O}$  and  $^{17}_8\text{O}$  are isotopes of oxygen, and  $^{16}_8\text{O}$  has  $16 - 8 = 8$  neutrons whereas  $^{17}_8\text{O}$  has  $17 - 8 = 9$  neutrons.

**Same  $Z$  value**

b)  $^{40}_{18}\text{Ar}$  and  $^{41}_{19}\text{K}$  have the **same number of neutrons** (Ar:  $40 - 18 = 22$ ; K:  $41 - 19 = 22$ ) but different numbers of protons and electrons (Ar = 18 protons and 18 electrons; K = 19 protons and 19 electrons). **Same  $N$  value**

c)  $^{60}_{27}\text{Co}$  and  $^{60}_{28}\text{Ni}$  have different numbers of protons, neutrons, and electrons. Co: 27 protons, 27 electrons, and  $60 - 27 = 33$  neutrons; Ni: 28 protons, 28 electrons and  $60 - 28 = 32$  neutrons. However, both have a mass number of 60. **Same  $A$  value**

- 2.29 Plan: The superscript is the mass number ( $A$ ), the sum of the number of protons and neutrons; the subscript is the atomic number ( $Z$ , number of protons). The mass number – the number of protons = the number of neutrons. For atoms, the number of protons = the number of electrons.

Solution:

a)  $^3_1\text{H}$  and  $^3_2\text{He}$  have different numbers of protons, neutrons, and electrons. H: 1 proton, 1 electron, and  $3 - 1 = 2$  neutrons; He: 2 protons, 2 electrons, and  $3 - 2 = 1$  neutron. However, both have a mass number of 3.

**Same  $A$  value**

b)  $^{14}_6\text{C}$  and  $^{15}_7\text{N}$  have the **same number of neutrons** (C:  $14 - 6 = 8$ ; N:  $15 - 7 = 8$ ) but different numbers of protons and electrons (C = 6 protons and 6 electrons; N = 7 protons and 7 electrons). **Same  $N$  value**

c)  $^{19}_9\text{F}$  and  $^{18}_9\text{F}$  have the **same number of protons and electrons** (9), but different numbers of neutrons.

$^{19}_9\text{F}$  and  $^{18}_9\text{F}$  are isotopes of oxygen, and  $^{19}_9\text{F}$  has  $19 - 9 = 10$  neutrons whereas  $^{18}_9\text{F}$  has  $18 - 9 = 9$  neutrons.

**Same  $Z$  value**

- 2.30 Plan: Combine the particles in the nucleus (protons + neutrons) to give the mass number (superscript,  $A$ ). The number of protons gives the atomic number (subscript,  $Z$ ) and identifies the element.

Solution:

a)  $A = 18 + 20 = 38$ ;  $Z = 18$ ;  $^{38}_{18}\text{Ar}$

b)  $A = 25 + 30 = 55$ ;  $Z = 25$ ;  $^{55}_{25}\text{Mn}$

c)  $A = 47 + 62 = 109$ ;  $Z = 47$ ;  $^{109}_{47}\text{Ag}$

- 2.31 **Plan:** Combine the particles in the nucleus (protons + neutrons) to give the mass number (superscript,  $A$ ). The number of protons gives the atomic number (subscript,  $Z$ ) and identifies the element.

**Solution:**

a)  $A = 6 + 7 = 13$ ;  $Z = 6$ ;  ${}^1_6\text{C}$

b)  $A = 40 + 50 = 90$ ;  $Z = 40$ ;  ${}^{90}_{40}\text{Zr}$

c)  $A = 28 + 33 = 61$ ;  $Z = 28$ ;  ${}^{61}_{28}\text{Ni}$

- 2.32 **Plan:** Determine the number of each type of particle. The superscript is the mass number ( $A$ ) and the subscript is the atomic number ( $Z$ , number of protons). The mass number – the number of protons = the number of neutrons. For atoms, the number of protons = the number of electrons. The protons and neutrons are in the nucleus of the atom.

**Solution:**

a)  ${}^{48}_{22}\text{Ti}$

22 protons

22 electrons

$48 - 22 = 26$  neutrons

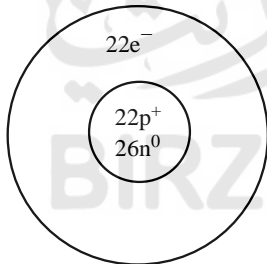

b)  ${}^{79}_{34}\text{Se}$

34 protons

34 electrons

$79 - 34 = 45$  neutrons

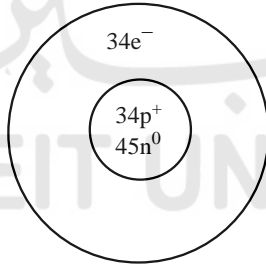

c)  ${}^{11}_5\text{B}$

5 protons

5 electrons

$11 - 5 = 6$  neutrons

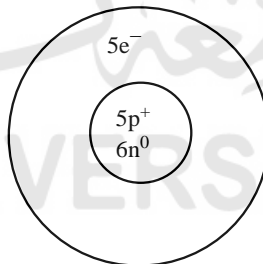

- 2.33 **Plan:** Determine the number of each type of particle. The superscript is the mass number ( $A$ ) and the subscript is the atomic number ( $Z$ , number of protons). The mass number – the number of protons = the number of neutrons. For atoms, the number of protons = the number of electrons. The protons and neutrons are in the nucleus of the atom.

**Solution:**

a)  ${}^{207}_{82}\text{Pb}$

82 protons

82 electrons

$207 - 82 = 125$  neutrons

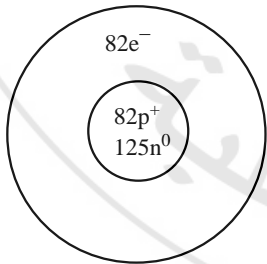

b)  ${}^9_4\text{Be}$

4 protons

4 electrons

$9 - 4 = 5$  neutrons

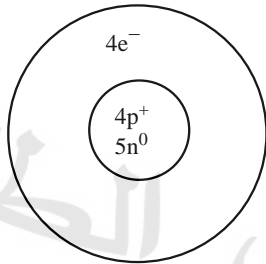

c)  ${}^{75}_{33}\text{As}$

33 protons

33 electrons

$75 - 33 = 42$  neutrons

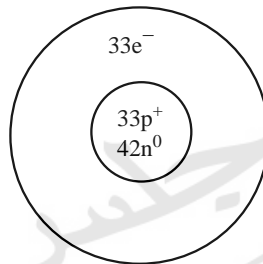

- 2.34 **Plan:** To calculate the atomic mass of an element, take a weighted average based on the natural abundance of the isotopes: (isotopic mass of isotope 1 x fractional abundance) + (isotopic mass of isotope 2 x fractional abundance).

**Solution:**

$$\text{Atomic mass of gallium} = (68.9256 \text{ amu})\left(\frac{60.11\%}{100\%}\right) + (70.9247 \text{ amu})\left(\frac{39.89\%}{100\%}\right) = 69.7230 = \mathbf{69.72 \text{ amu}}$$

- 2.35 **Plan:** To calculate the atomic mass of an element, take a weighted average based on the natural abundance of the isotopes: (isotopic mass of isotope 1 x fractional abundance) + (isotopic mass of isotope 2 x fractional abundance) + (isotopic mass of isotope 3 x fractional abundance).  
**Solution:**
- $$\text{Atomic mass of Mg} = (23.9850 \text{ amu})\left(\frac{78.99\%}{100\%}\right) + (24.9858 \text{ amu})\left(\frac{10.00\%}{100\%}\right) + (25.9826 \text{ amu})\left(\frac{11.01\%}{100\%}\right)$$
- $$= 24.3050 = \mathbf{24.31 \text{ amu}}$$
- 2.36 **Plan:** To find the percent abundance of each Cl isotope, let x equal the fractional abundance of  $^{35}\text{Cl}$  and  $(1 - x)$  equal the fractional abundance of  $^{37}\text{Cl}$  since the sum of the fractional abundances must equal 1. Remember that atomic mass = (isotopic mass of  $^{35}\text{Cl}$  x fractional abundance) + (isotopic mass of  $^{37}\text{Cl}$  x fractional abundance).  
**Solution:**
- $$\text{Atomic mass} = (\text{isotopic mass of } ^{35}\text{Cl} \times \text{fractional abundance}) + (\text{isotopic mass of } ^{37}\text{Cl} \times \text{fractional abundance})$$
- $$35.4527 \text{ amu} = 34.9689 \text{ amu}(x) + 36.9659 \text{ amu}(1 - x)$$
- $$35.4527 \text{ amu} = 34.9689 \text{ amu}(x) + 36.9659 \text{ amu} - 36.9659 \text{ amu}(x)$$
- $$35.4527 \text{ amu} = 36.9659 \text{ amu} - 1.9970 \text{ amu}(x)$$
- $$1.9970 \text{ amu}(x) = 1.5132 \text{ amu}$$
- $$x = 0.75774 \text{ and } 1 - x = 1 - 0.75774 = 0.24226$$
- $$\% \text{ abundance } ^{35}\text{Cl} = \mathbf{75.774\%} \quad \% \text{ abundance } ^{37}\text{Cl} = \mathbf{24.226\%}$$
- 2.37 **Plan:** To find the percent abundance of each Cu isotope, let x equal the fractional abundance of  $^{63}\text{Cu}$  and  $(1 - x)$  equal the fractional abundance of  $^{65}\text{Cu}$  since the sum of the fractional abundances must equal 1. Remember that atomic mass = (isotopic mass of  $^{63}\text{Cu}$  x fractional abundance) + (isotopic mass of  $^{65}\text{Cu}$  x fractional abundance).  
**Solution:**
- $$\text{Atomic mass} = (\text{isotopic mass of } ^{63}\text{Cu} \times \text{fractional abundance}) + (\text{isotopic mass of } ^{65}\text{Cu} \times \text{fractional abundance})$$
- $$63.546 \text{ amu} = 62.9396 \text{ amu}(x) + 64.9278 \text{ amu}(1 - x)$$
- $$63.546 \text{ amu} = 62.9396 \text{ amu}(x) + 64.9278 \text{ amu} - 64.9278 \text{ amu}(x)$$
- $$63.546 \text{ amu} = 64.9278 \text{ amu} - 1.9882 \text{ amu}(x)$$
- $$1.9882 \text{ amu}(x) = 1.3818 \text{ amu}$$
- $$x = 0.69500 \text{ and } 1 - x = 1 - 0.69500 = 0.30500$$
- $$\% \text{ abundance } ^{63}\text{Cu} = \mathbf{69.50\%} \quad \% \text{ abundance } ^{65}\text{Cu} = \mathbf{30.50\%}$$
- 2.38 **Plan:** Review the section in the chapter on the periodic table.  
**Solution:**
- In the modern periodic table, the elements are arranged in order of increasing atomic **number**.
  - Elements in a **column or group** (or family) have similar chemical properties, not those in the same period or row.
  - Elements can be classified as **metals**, metalloids, or nonmetals.
- 2.39 The **metalloids** lie along the “staircase” line, with properties intermediate between metals and nonmetals.
- 2.40 **Plan:** Review the section on the classification of elements as metals, nonmetals, or metalloids.  
**Solution:**
- To the left of the “staircase” are the metals, which are generally hard, shiny, malleable, ductile, good conductors of heat and electricity, and form positive ions by losing electrons. To the right of the “staircase” are the nonmetals, which are generally soft or gaseous, brittle, dull, poor conductors of heat and electricity, and form negative ions by gaining electrons.
- 2.41 **Plan:** Locate each element on the periodic table. The Z value is the atomic number of the element. Metals are to the left of the “staircase,” nonmetals are to the right of the “staircase,” and the metalloids are the elements that lie along the “staircase” line.

Solution:

- a) Germanium Ge 4A(14) metalloid
- b) Phosphorus P 5A(15) nonmetal
- c) Helium He 8A(18) nonmetal
- d) Lithium Li 1A(1) metal
- e) Molybdenum Mo 6B(6) metal

2.42 Plan: Locate each element on the periodic table. The Z value is the atomic number of the element. Metals are to the left of the “staircase,” nonmetals are to the right of the “staircase,” and the metalloids are the elements that lie along the “staircase” line.

Solution:

- a) Arsenic As 5A(15) metalloid
- b) Calcium Ca 2A(2) metal
- c) Bromine Br 7A(17) nonmetal
- d) Potassium K 1A(1) metal
- e) Aluminum Al 3A(13) metal

2.43 Plan: Review the section in the chapter on the periodic table. Remember that alkaline earth metals are in Group 2A(2), the halogens are in Group 7A(17), and the metalloids are the elements that lie along the “staircase” line; periods are horizontal rows.

Solution:

- a) The symbol and atomic number of the heaviest alkaline earth metal are **Ra** and **88**.
- b) The symbol and atomic number of the lightest metalloid in Group 4A(14) are **Si** and **14**.
- c) The symbol and atomic mass of the coinage metal whose atoms have the fewest electrons are **Cu** and **63.55 amu**.
- d) The symbol and atomic mass of the halogen in Period 4 are **Br** and **79.90 amu**.

2.44 Plan: Review the section in the chapter on the periodic table. Remember that the noble gases are in Group 8A(18), the alkali metals are in Group 1A(1), and the transition elements are the groups of elements located between Groups 2A(s) and 3A(13); periods are horizontal rows and metals are located to the left of the “staircase” line.

Solution:

- a) The symbol and atomic number of the heaviest nonradioactive noble gas are **Xe** and **54**, respectively.
- b) The symbol and group number of the Period 5 transition element whose atoms have the fewest protons are **Y** and **3B(3)**.
- c) The symbol and atomic number of the only metallic chalcogen are **Po** and **84**.
- d) The symbol and number of protons of the Period 4 alkali metal atom are **K** and **19**.

2.45 Plan: Review the section of the chapter on the formation of ionic compounds.

Solution:

Reactive metals and nonmetals will form **ionic** bonds, in which one or more electrons are transferred from the metal atom to the nonmetal atom to form a cation and an anion, respectively. The oppositely charged ions attract, forming the ionic bond.

2.46 Plan: Review the section of the chapter on the formation of covalent compounds.

Solution:

Two nonmetals will form **covalent** bonds, in which the atoms share two or more electrons.

2.47 Plan: Assign charges to each of the ions. Since the sizes are similar, there are no differences due to the sizes.

Solution:

Coulomb’s law states the energy of attraction in an ionic bond is directly proportional to the *product of charges* and inversely proportional to the *distance between charges*. The *product of charges* in MgO (+2 x -2 = -4) is greater than the *product of charges* in LiF (+1 x -1 = -1). Thus, **MgO** has stronger ionic bonding.

- 2.48 Plan: A metal and a nonmetal will form an ionic compound. Locate these elements on the periodic table and predict their charges.  
Solution:  
 Magnesium chloride ( $\text{MgCl}_2$ ) is an ionic compound formed from a metal (magnesium) and a nonmetal (chlorine). Magnesium atoms transfer electrons to chlorine atoms. Each magnesium atom loses two electrons to form a  $\text{Mg}^{2+}$  ion and the same number of electrons (10) as the noble gas neon. Each chlorine atom gains one electron to form a  $\text{Cl}^-$  ion and the same number of electrons (18) as the noble gas argon. The  $\text{Mg}^{2+}$  and  $\text{Cl}^-$  ions attract each other to form an ionic compound with the ratio of one  $\text{Mg}^{2+}$  ion to two  $\text{Cl}^-$  ions. The total number of electrons lost by the magnesium atoms equals the total number of electrons gained by the chlorine atoms.
- 2.49 Plan: Recall that ionic bonds occur between metals and nonmetals, whereas covalent bonds occur between nonmetals.  
Solution:  
 $\text{KNO}_3$  shows **both** ionic and covalent bonding, covalent bonding between the N and O in  $\text{NO}_3^-$  and ionic bonding between the  $\text{NO}_3^-$  and the  $\text{K}^+$ .
- 2.50 Plan: Locate these elements on the periodic table and predict what ions they will form. For A group cations (metals), ion charge = group number; for anions (nonmetals), ion charge = group number minus 8.  
Solution:  
 Potassium (K) is in Group 1A(1) and forms the  $\text{K}^+$  ion. Iodine (I) is in Group 7A(17) and forms the  $\text{I}^-$  ion ( $7 - 8 = -1$ ).
- 2.51 Plan: Locate these elements on the periodic table and predict what ions they will form. For A group cations (metals), ion charge = group number; for anions (nonmetals), ion charge = group number minus 8.  
Solution:  
 Barium in Group 2A(2) forms a +2 ion:  $\text{Ba}^{2+}$ . Selenium in Group 6A(16) forms a -2 ion:  $\text{Se}^{2-}$  ( $6 - 8 = -2$ ).
- 2.52 Plan: Use the number of protons (atomic number) to identify the element. Add the number of protons and neutrons together to get the mass number. Locate the element on the periodic table and assign its group and period number.  
Solution:
- |                                 |                                |              |          |
|---------------------------------|--------------------------------|--------------|----------|
| a) Oxygen (atomic number = 8)   | mass number = $8p + 9n = 17$   | Group 6A(16) | Period 2 |
| b) Fluorine (atomic number = 9) | mass number = $9p + 10n = 19$  | Group 7A(17) | Period 2 |
| c) Calcium (atomic number = 20) | mass number = $20p + 20n = 40$ | Group 2A(2)  | Period 4 |
- 2.53 Plan: Use the number of protons (atomic number) to identify the element. Add the number of protons and neutrons together to get the mass number. Locate the element on the periodic table and assign its group and period number.  
Solution:
- |                                  |                                |              |          |
|----------------------------------|--------------------------------|--------------|----------|
| a) Bromine (atomic number = 35)  | mass number = $35p + 44n = 79$ | Group 7A(17) | Period 4 |
| b) Nitrogen (atomic number = 7)  | mass number = $7p + 8n = 15$   | Group 5A(15) | Period 2 |
| c) Rubidium (atomic number = 37) | mass number = $37p + 48n = 85$ | Group 1A(1)  | Period 5 |
- 2.54 Plan: Determine the charges of the ions based on their position on the periodic table. For A group cations (metals), ion charge = group number; for anions (nonmetals), ion charge = group number minus 8. Next, determine the ratio of the charges to get the ratio of the ions.  
Solution:  
 Lithium [Group 1A(1)] forms the  $\text{Li}^+$  ion; oxygen [Group 6A(16)] forms the  $\text{O}^{2-}$  ion ( $6 - 8 = -2$ ). The ionic compound that forms from the combination of these two ions must be electrically neutral, so two  $\text{Li}^+$  ions combine with one  $\text{O}^{2-}$  ion to form the compound  $\text{Li}_2\text{O}$ . There are twice as many  $\text{Li}^+$  ions as  $\text{O}^{2-}$  ions in a sample of  $\text{Li}_2\text{O}$ .

$$\text{Number of } \text{O}^{2-} \text{ ions} = (8.4 \times 10^{21} \text{ Li}^+ \text{ ions}) \left( \frac{1 \text{ O}^{2-} \text{ ion}}{2 \text{ Li}^+ \text{ ions}} \right) = 4.2 \times 10^{21} \text{ O}^{2-} \text{ ions}$$

- 2.55 **Plan:** Determine the charges of the ions based on their position on the periodic table. For A group cations (metals), ion charge = group number; for anions (nonmetals), ion charge = group number minus 8. Next, determine the ratio of the charges to get the ratio of the ions.  
**Solution:**  
 Ca [Group 2A(2)] forms  $\text{Ca}^{2+}$  and I [Group 7A(17)] forms  $\text{I}^-$  ions ( $7 - 8 = -1$ ). The ionic compound that forms from the combination of these two ions must be electrically neutral, so one  $\text{Ca}^{2+}$  ion combines with two  $\text{I}^-$  ions to form the compound  $\text{CaI}_2$ . There are twice as many  $\text{I}^-$  ions as  $\text{Ca}^{2+}$  ions in a sample of  $\text{CaI}_2$ .
- $$\text{Number of } \text{I}^- \text{ ions} = (7.4 \times 10^{21} \text{ Ca}^{2+} \text{ ions}) \left( \frac{2 \text{ I}^- \text{ ions}}{1 \text{ Ca}^{2+} \text{ ion}} \right) = 1.48 \times 10^{22} = \mathbf{1.5 \times 10^{22} \text{ I}^- \text{ ions}}$$
- 2.56 **Plan:** The key is the size of the two alkali metal ions. The charges on the sodium and potassium ions are the same as both are in Group 1A(1), so there will be no difference due to the charge. The chloride ions are the same in size and charge, so there will be no difference due to the chloride ion.  
**Solution:**  
 Coulomb's law states that the energy of attraction in an ionic bond is directly proportional to the *product of charges* and inversely proportional to the *distance between charges*. The *product of the charges* is the same in both compounds because both sodium and potassium ions have a +1 charge. Attraction increases as distance decreases, so the ion with the smaller radius,  $\text{Na}^+$ , will form a stronger ionic interaction (**NaCl**).
- 2.57 **Plan:** The key is the charge of the two metal ions. The sizes of the lithium and magnesium ions are about the same (magnesium is slightly smaller), so there will be little difference due to ion size. The oxide ions are the same in size and charge, so there will be no difference due to the oxide ion.  
**Solution:**  
 Coulomb's law states the energy of attraction in an ionic bond is directly proportional to the *product of charges* and inversely proportional to the *distance between charges*. The *product of charges* in  $\text{MgO}$  ( $+2 \times -2 = -4$ ) is greater than the *product of charges* in  $\text{Li}_2\text{O}$  ( $+1 \times -2 = -2$ ). Thus, **MgO** has stronger ionic bonding.
- 2.58 **Plan:** Review the definitions of molecular and structural formulas.  
**Solution:**  
 Both the structural and molecular formulas show the actual numbers of each type of atom in the molecule; in addition, the structural formula shows the arrangement of the atoms (i.e., how the atoms are connected to each other).
- 2.59 **Plan:** Review the concepts of atoms and molecules.  
**Solution:**  
 The mixture is similar to the sample of hydrogen peroxide in that both contain 20 billion oxygen atoms and 20 billion hydrogen atoms since both  $\text{O}_2$  and  $\text{H}_2\text{O}_2$  contain 2 oxygen atoms per molecule and both  $\text{H}_2$  and  $\text{H}_2\text{O}_2$  contain 2 hydrogen atoms per molecule. They differ in that they contain different types of molecules:  $\text{H}_2\text{O}_2$  molecules in the hydrogen peroxide sample and  $\text{H}_2$  and  $\text{O}_2$  molecules in the mixture. In addition, the mixture contains 20 billion molecules (10 billion  $\text{H}_2$  molecules + 10 billion  $\text{O}_2$  molecules) while the hydrogen peroxide sample contains 10 billion molecules.
- 2.60 **Plan:** Write the symbol of each element present in the compound; the given number of each type of atom is represented with a subscript.  
**Solution:**  
 a) Hydrazine has two nitrogen atoms and four hydrogen atoms:  $\text{N}_2\text{H}_4$ .  
 b) Glucose has six carbon atoms, twelve hydrogen atoms, and six oxygen atoms:  $\text{C}_6\text{H}_{12}\text{O}_6$ .
- 2.61 **Plan:** Write the symbol of each element present in the compound; the given number of each type of atom is represented with a subscript.  
**Solution:**  
 a) Ethylene glycol has two carbon atoms, six hydrogen atoms, and two oxygen atoms:  $\text{C}_2\text{H}_6\text{O}_2$ .  
 b) Peroxodisulfuric acid has two hydrogen atoms, two sulfur atoms, and eight oxygen atoms:  $\text{H}_2\text{S}_2\text{O}_8$ .

2.62 Plan: Locate each of the individual elements on the periodic table, and assign charges to each of the ions. For A group cations (metals), ion charge = group number; for anions (nonmetals), ion charge = group number minus 8. Find the smallest number of each ion that gives a neutral compound. To name ionic compounds with metals that form only one ion, name the metal, followed by the nonmetal name with an -ide suffix.

Solution:

a) Sodium is a metal that forms a +1 (Group 1A) ion and nitrogen is a nonmetal that forms a -3 ion (Group 5A,  $5 - 8 = -3$ ).

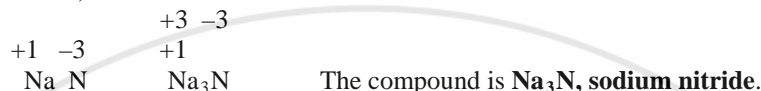

b) Oxygen is a nonmetal that forms a -2 ion (Group 6A,  $6 - 8 = -2$ ) and strontium is a metal that forms a +2 ion (Group 2A).

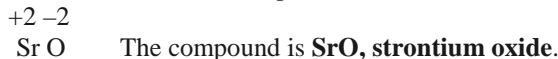

c) Aluminum is a metal that forms a +3 ion (Group 3A) and chlorine is a nonmetal that forms a -1 ion (Group 7A,  $7 - 8 = -1$ ).

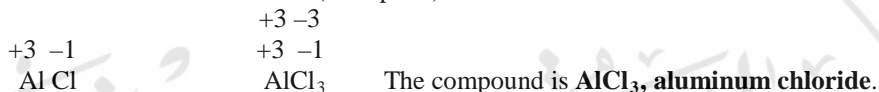

2.63 Plan: Locate each of the individual elements on the periodic table, and assign charges to each of the ions. For A group cations (metals), ion charge = group number; for anions (nonmetals), ion charge = group number minus 8. Find the smallest number of each ion that gives a neutral compound. To name ionic compounds with metals that form only one ion, name the metal, followed by the nonmetal name with an -ide suffix.

Solution:

a) Cesium is a metal that forms a +1 (Group 1A) ion and bromine is a nonmetal that forms a -1 ion (Group 7A,  $7 - 8 = -1$ ).



b) Sulfur is a nonmetal that forms a -2 ion (Group 6A,  $6 - 8 = -2$ ) and barium is a metal that forms a +2 ion (Group 2A).

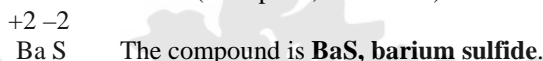

c) Fluorine is a nonmetal that forms a -1 ion (Group 7A,  $7 - 8 = -1$ ) and calcium is a metal that forms a +2 ion (Group 2A).



2.64 Plan: Based on the atomic numbers (the subscripts) locate the elements on the periodic table. Once the atomic numbers are located, identify the element and based on its position, assign a charge. For A group cations (metals), ion charge = group number; for anions (nonmetals), ion charge = group number minus 8. Find the smallest number of each ion that gives a neutral compound. To name ionic compounds with metals that form only one ion, name the metal, followed by the nonmetal name with an -ide suffix.

Solution:

a)  ${}_{12}\text{L}$  is the element Mg ( $Z = 12$ ). Magnesium [Group 2A(2)] forms the  $\text{Mg}^{2+}$  ion.  ${}_{9}\text{M}$  is the element F ( $Z = 9$ ). Fluorine [Group 7A(17)] forms the  $\text{F}^{-}$  ion ( $7 - 8 = -1$ ). The compound formed by the combination of these two elements is  **$\text{MgF}_2$ , magnesium fluoride.**

b)  ${}_{30}\text{L}$  is the element Zn ( $Z = 30$ ). Zinc forms the  $\text{Zn}^{2+}$  ion (see Table 2.3).  ${}_{16}\text{M}$  is the element S ( $Z = 16$ ). Sulfur [Group 6A(16)] will form the  $\text{S}^{2-}$  ion ( $6 - 8 = -2$ ). The compound formed by the combination of these two elements is  **$\text{ZnS}$ , zinc sulfide.**

c)  ${}_{17}\text{L}$  is the element Cl ( $Z = 17$ ). Chlorine [Group 7A(17)] forms the  $\text{Cl}^{-}$  ion ( $7 - 8 = -1$ ).  ${}_{38}\text{M}$  is the element Sr ( $Z = 38$ ). Strontium [Group 2A(2)] forms the  $\text{Sr}^{2+}$  ion. The compound formed by the combination of these two elements is  **$\text{SrCl}_2$ , strontium chloride.**

2.65 Plan: Based on the atomic numbers (the subscripts) locate the elements on the periodic table. Once the atomic numbers are located, identify the element and based on its position, assign a charge. For A group cations (metals), ion charge = group number; for anions (nonmetals), ion charge = group number minus 8. Find the smallest number of each ion that gives a neutral compound. To name ionic compounds with metals that form only one ion, name the metal, followed by the nonmetal name with an -ide suffix.

Solution:

- a)  ${}_{37}\text{Q}$  is the element Rb ( $Z = 37$ ). Rubidium [Group 1A(1)] forms the  $\text{Rb}^+$  ion.  ${}_{35}\text{R}$  is the element Br ( $Z = 35$ ). Bromine [Group 7A(17)] forms the  $\text{Br}^-$  ion ( $7 - 8 = -1$ ). The compound formed by the combination of these two elements is **RbBr, rubidium bromide**.
- b)  ${}_{8}\text{Q}$  is the O ( $Z = 8$ ). Oxygen [Group 6A(16)] will form the  $\text{O}^{2-}$  ion ( $6 - 8 = -2$ ).  ${}_{13}\text{R}$  is the element Al ( $Z = 13$ ). Aluminum [Group 3A(13)] forms the  $\text{Al}^{3+}$  ion. The compound formed by the combination of these two elements is  **$\text{Al}_2\text{O}_3$ , aluminum oxide**.
- c)  ${}_{20}\text{Q}$  is the element Ca ( $Z = 20$ ). Calcium [Group 2A(2)] forms the  $\text{Ca}^{2+}$  ion.  ${}_{53}\text{R}$  is the element I ( $Z = 53$ ). Iodine [Group 7A(17)] forms the  $\text{I}^-$  ion ( $7 - 8 = -1$ ). The compound formed by the combination of these two elements is  **$\text{CaI}_2$ , calcium iodide**.

- 2.66 Plan: Review the rules for nomenclature covered in the chapter. For ionic compounds, name the metal, followed by the nonmetal name with an -ide suffix. For metals, like many transition metals, that can form more than one ion each with a different charge, the ionic charge of the metal ion is indicated by a Roman numeral within parentheses immediately following the metal's name.

Solution:

- a) tin(IV) chloride =  **$\text{SnCl}_4$**  The (IV) indicates that the metal ion is  $\text{Sn}^{4+}$  which requires 4  $\text{Cl}^-$  ions for a neutral compound.
- b)  $\text{FeBr}_3$  = **iron(III) bromide** (common name is ferric bromide); the charge on the iron ion is +3 to match the  $-3$  charge of 3  $\text{Br}^-$  ions. The +3 charge of the Fe is indicated by (III). +6 -6
- c) cuprous bromide =  **$\text{CuBr}$**  (cuprous is +1 copper ion, cupric is +2 copper ion). +3 -2
- d)  $\text{Mn}_2\text{O}_3$  = **manganese(III) oxide** Use (III) to indicate the +3 ionic charge of Mn:  $\text{Mn}_2\text{O}_3$

- 2.67 Plan: Review the rules for nomenclature covered in the chapter. For ionic compounds containing polyatomic ions, name the metal, followed by the name of the polyatomic ion. Hydrates, compounds with a specific number of water molecules associated with them, are named with a prefix before the word hydrate to indicate the number of water molecules.

Solution:

- a)  $\text{Na}_2\text{HPO}_4$  = **sodium hydrogen phosphate** Sodium [Group 1A(1)] forms the  $\text{Na}^+$  ion;  $\text{HPO}_4^{2-}$  is the hydrogen phosphate ion.
- b) potassium carbonate dihydrate =  **$\text{K}_2\text{CO}_3 \cdot 2\text{H}_2\text{O}$**  Potassium [Group 1A(1)] forms the  $\text{K}^+$  ion; carbonate is the  $\text{CO}_3^{2-}$  ion. Two  $\text{K}^+$  ions are required to match the  $-2$  charge of the carbonate ion. Dihydrate indicates two water molecules ("waters of hydration") that are written after a centered dot.
- c)  $\text{NaNO}_2$  = **sodium nitrite**  $\text{NO}_2^-$  is the nitrite polyatomic ion.
- d) ammonium perchlorate =  **$\text{NH}_4\text{ClO}_4$**  Ammonium is the polyatomic ion  $\text{NH}_4^+$  and perchlorate is the polyatomic ion  $\text{ClO}_4^-$ . One  $\text{NH}_4^+$  is required for every one  $\text{ClO}_4^-$  ion.

- 2.68 Plan: Review the rules for nomenclature covered in the chapter. For metals, like many transition metals, that can form more than one ion each with a different charge, the ionic charge of the metal ion is indicated by a Roman numeral within parentheses immediately following the metal's name. Compounds must be neutral.

Solution:

- a) Barium [Group 2A(2)] forms  $\text{Ba}^{2+}$  and oxygen [Group 6A(16)] forms  $\text{O}^{2-}$  ( $6 - 8 = -2$ ) so the neutral compound forms from one  $\text{Ba}^{2+}$  ion and one  $\text{O}^{2-}$  ion. Correct formula is  **$\text{BaO}$** .
- b) Iron(II) indicates  $\text{Fe}^{2+}$  and nitrate is  $\text{NO}_3^-$  so the neutral compound forms from one iron(II) ion and two nitrate ions. Correct formula is  **$\text{Fe}(\text{NO}_3)_2$** .
- c) Mn is the symbol for manganese. Mg is the correct symbol for magnesium. Correct formula is  **$\text{MgS}$** . Sulfide is the  $\text{S}^{2-}$  ion and sulfite is the  $\text{SO}_3^{2-}$  ion.

- 2.69 Plan: Review the rules for nomenclature covered in the chapter. For metals, like many transition metals, that can form more than one ion each with a different charge, the ionic charge of the metal ion is indicated by a Roman numeral within parentheses immediately following the metal's name. Compounds must be neutral.

Solution:

- a) **copper(I) iodide** Cu is copper, not cobalt; since iodide is  $\text{I}^-$ , this must be copper(I).
- b) **iron(III) hydrogen sulfate**  $\text{HSO}_4^-$  is hydrogen sulfate, and this must be iron(III) to be neutral.
- c) **magnesium dichromate** Mg forms  $\text{Mg}^{2+}$  and  $\text{Cr}_2\text{O}_7^{2-}$  is named dichromate ion.



- 2.70 Plan: Acids donate  $H^+$  ion to the solution, so the acid is a combination of  $H^+$  and a negatively charged ion. Binary acids (H plus one other nonmetal) are named hydro- + nonmetal root + -ic acid. Oxoacids (H + an oxoanion) are named by changing the suffix of the oxoanion: -ate becomes -ic acid and -ite becomes -ous acid.  
Solution:  
a) Hydrogen sulfate is  $HSO_4^-$ , so its source acid is  $H_2SO_4$ . Name of acid is **sulfuric acid** (-ate becomes -ic acid).  
b) **HIO<sub>3</sub>, iodic acid**  $IO_3^-$  is the iodate ion: -ate becomes -ic acid.  
c) Cyanide is  $CN^-$ ; its source acid is **HCN hydrocyanic acid** (binary acid).  
d) **H<sub>2</sub>S, hydrosulfuric acid** (binary acid).
- 2.71 Plan: Acids donate  $H^+$  ion to the solution, so the acid is a combination of  $H^+$  and a negatively charged ion. Binary acids (H plus one other nonmetal) are named hydro- + nonmetal root + -ic acid. Oxoacids (H + an oxoanion) are named by changing the suffix of the oxoanion: -ate becomes -ic acid and -ite becomes -ous acid.  
Solution:  
a) Perchlorate is  $ClO_4^-$ , so the source acid is **HClO<sub>4</sub>**. Name of acid is **perchloric acid** (-ate becomes -ic acid).  
b) **nitric acid, HNO<sub>3</sub>**  $NO_3^-$  is the nitrate ion: -ate becomes -ic acid.  
c) Bromite is  $BrO_2^-$ , so the source acid is **HBrO<sub>2</sub>**. Name of acid is **bromous acid** (-ite becomes -ous acid).  
d) **hydrofluoric acid, HF** (binary acid)
- 2.72 Plan: This compound is composed of two nonmetals. The element with the lower group number is named first. Greek numerical prefixes are used to indicate the number of atoms of each element in the compound.  
Solution:  
**disulfur tetrafluoride**  $S_2F_4$  Di- indicates two S atoms and tetra- indicates four F atoms.
- 2.73 Plan: This compound is composed of two nonmetals. When a compound contains oxygen and a halogen, the halogen is named first. Greek numerical prefixes are used to indicate the number of atoms of each element in the compound.  
Solution:  
**dichlorine monoxide**  $Cl_2O$  Di- indicates two Cl atoms and mono- indicates one O atom.
- 2.74 Plan: Break down each formula to the individual elements and count the number of atoms of each element by observing the subscripts. The molecular (formula) mass is the sum of the atomic masses of all of the atoms.  
Solution:  
a) There are **12 atoms of oxygen** in  $Al_2(SO_4)_3$ . The molecular mass is:  

Al	=	2(26.98 amu)	=	53.96 amu
S	=	3(32.07 amu)	=	96.21 amu
O	=	12(16.00 amu)	=	<u>192.0 amu</u>
				<b>342.2 amu</b>

  
b) There are **9 atoms of hydrogen** in  $(NH_4)_2HPO_4$ . The molecular mass is:  

N	=	2(14.01 amu)	=	28.02 amu
H	=	9(1.008 amu)	=	9.072 amu
P	=	1(30.97 amu)	=	30.97 amu
O	=	4(16.00 amu)	=	<u>64.00 amu</u>
				<b>132.06 amu</b>

  
c) There are **8 atoms of oxygen** in  $Cu_3(OH)_2(CO_3)_2$ . The molecular mass is:  

Cu	=	3(63.55 amu)	=	190.6 amu
O	=	8(16.00 amu)	=	128.0 amu
H	=	2(1.008 amu)	=	2.016 amu
C	=	2(12.01 amu)	=	<u>24.02 amu</u>
				<b>344.6 amu</b>

2.75 Plan: Break down each formula to the individual elements and count the number of atoms of each element by observing the subscripts. The molecular (formula) mass is the sum of the atomic masses of all of the atoms.

Solution:

a) There are **9 atoms of hydrogen** in  $C_6H_5COONH_4$ . The molecular mass is:

C	=	7(12.01 amu)	=	84.07 amu
H	=	9(1.008 amu)	=	9.072 amu
O	=	2(16.00 amu)	=	32.00 amu
N	=	1(14.01 amu)	=	<u>14.01 amu</u>
				<b>139.15 amu</b>

b) There are **2 atoms of nitrogen** in  $N_2H_6SO_4$ . The molecular mass is:

N	=	2(14.01 amu)	=	28.02 amu
H	=	6(1.008 amu)	=	6.048 amu
S	=	1(32.07 amu)	=	32.07 amu
O	=	4(16.00 amu)	=	<u>64.00 amu</u>
				<b>130.14 amu</b>

c) There are **12 atoms of oxygen** in  $Pb_4SO_4(CO_3)_2(OH)_2$ . The molecular mass is:

Pb	=	4(207.2 amu)	=	828.8 amu
S	=	1(32.07 amu)	=	32.07 amu
O	=	12(16.00 amu)	=	192.00 amu
C	=	2(12.01 amu)	=	24.02 amu
H	=	2(1.008 amu)	=	<u>2.016 amu</u>
				<b>1078.9 amu</b>

2.76 Plan: Review the rules for nomenclature covered in the chapter. For ionic compounds containing polyatomic ions, name the metal, followed by the name of the polyatomic ion. The molecular (formula) mass is the sum of the atomic masses of all of the atoms.

Solution:

a)  $(NH_4)_2SO_4$  ammonium is  $NH_4^+$  and sulfate is  $SO_4^{2-}$

N	=	2(14.01 amu)	=	28.02 amu
H	=	8(1.008 amu)	=	8.064 amu
S	=	1(32.07 amu)	=	32.07 amu
O	=	4(16.00 amu)	=	<u>64.00 amu</u>
				<b>132.15 amu</b>

b)  $NaH_2PO_4$  sodium is  $Na^+$  and dihydrogen phosphate is  $H_2PO_4^-$

Na	=	1(22.99 amu)	=	22.99 amu
H	=	2(1.008 amu)	=	2.016 amu
P	=	1(30.97 amu)	=	30.97 amu
O	=	4(16.00 amu)	=	<u>64.00 amu</u>
				<b>119.98 amu</b>

c)  $KHCO_3$  potassium is  $K^+$  and bicarbonate is  $HCO_3^-$

K	=	1(39.10 amu)	=	39.10 amu
H	=	1(1.008 amu)	=	1.008 amu
C	=	1(12.01 amu)	=	12.01 amu
O	=	3(16.00 amu)	=	<u>48.00 amu</u>
				<b>100.12 amu</b>

2.77 Plan: Review the rules for nomenclature covered in the chapter. For ionic compounds containing polyatomic ions, name the metal, followed by the name of the polyatomic ion. The molecular (formula) mass is the sum of the atomic masses of all of the atoms.

Solution:

a)  $Na_2Cr_2O_7$  sodium is  $Na^+$  and dichromate is  $Cr_2O_7^{2-}$

Na	=	2(22.99 amu)	=	45.98 amu
Cr	=	2(52.00 amu)	=	104.00 amu
O	=	7(16.00 amu)	=	<u>112.00 amu</u>
				<b>261.98 amu</b>

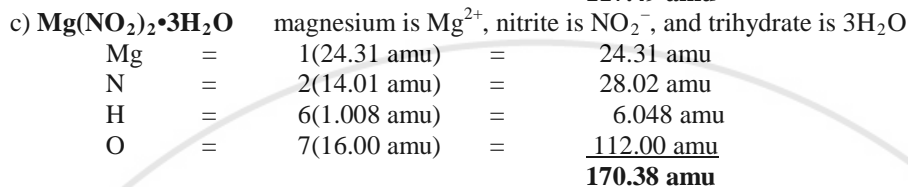
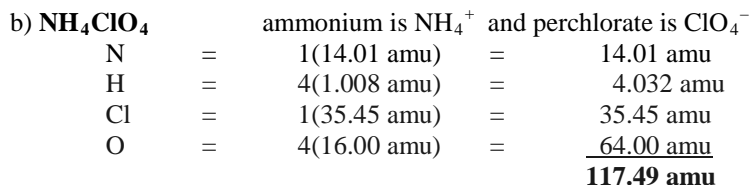

2.78 **Plan:** Use the chemical symbols and count the atoms of each type to give a molecular formula. Use the nomenclature rules in the chapter to derive the name. The molecular (formula) mass is the sum of the masses of each atom times its atomic mass.

**Solution:**

a) Formula is  $\text{SO}_3$ . Name is **sulfur trioxide** (the prefix tri- indicates 3 oxygen atoms).

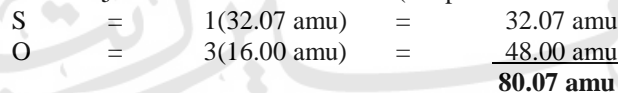

b) Formula is  $\text{C}_3\text{H}_8$ . Since it contains only carbon and hydrogen it is a hydrocarbon and with three carbons its name is **propane**.

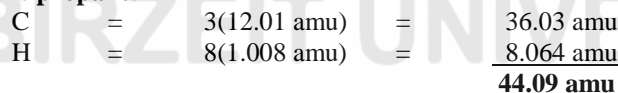

2.79 **Plan:** Use the chemical symbols and count the atoms of each type to give a molecular formula. Use the nomenclature rules in the chapter to derive the name. The molecular (formula) mass is the sum of the masses of each atom times its atomic mass.

**Solution:**

a) Formula is  $\text{N}_2\text{O}$ . Name is **dinitrogen monoxide** (the prefix di- indicates 2 nitrogen atoms and mono- indicates 1 oxygen atom).

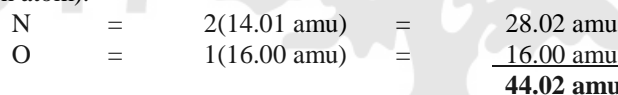

b) Formula is  $\text{C}_2\text{H}_6$ . Since it contains only carbon and hydrogen it is a hydrocarbon and with three carbons its name is **ethane**.

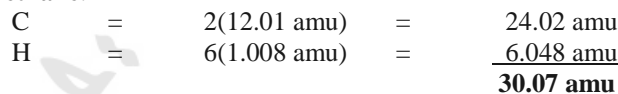

2.80 **Plan:** Review the law of mass conservation and law of definite composition. For each experiment, compare the mass values before and after each reaction and examine the ratios of the mass of reacted sodium to the mass of reacted chlorine.

**Solution:**

In each case, the mass of the starting materials (reactants) equals the mass of the ending materials (products), so the law of mass conservation is observed.

Case 1:  $39.34 \text{ g} + 60.66 \text{ g} = 100.00 \text{ g}$

Case 2:  $39.34 \text{ g} + 70.00 \text{ g} = 100.00 \text{ g} + 9.34 \text{ g}$

Case 3:  $50.00 \text{ g} + 50.00 \text{ g} = 82.43 \text{ g} + 17.57 \text{ g}$

Each reaction yields the product  $\text{NaCl}$ , not  $\text{Na}_2\text{Cl}$  or  $\text{NaCl}_2$  or some other variation, so the law of definite composition is observed. In each case, the ratio of the mass of sodium to the mass of chlorine in the compound is the same.

Case 1:  $\text{Mass Na/mass Cl}_2 = 39.34 \text{ g}/60.66 \text{ g} = 0.6485$

Case 2: Mass of reacted  $\text{Cl}_2$  = initial mass – excess mass = 70.00 g – 9.34 g = 60.66 g  $\text{Cl}_2$

Mass Na/mass  $\text{Cl}_2$  = 39.34 g/60.66 g = 0.6485

Case 3: Mass of reacted Na = initial mass – excess mass = 50.00 g – 17.57 g = 32.43 g Na

Mass Na/mass  $\text{Cl}_2$  = 32.43 g/50.00 g = 0.6486

- 2.81 Plan: Review the nomenclature rules in the chapter. For ionic compounds, name the metal, followed by the nonmetal name with an -ide suffix. For ionic compounds containing polyatomic ions, name the metal, followed by the name of the polyatomic ion. For metals, like many transition metals, that can form more than one ion each with a different charge, the ionic charge of the metal ion is indicated by a Roman numeral within parentheses immediately following the metal's name. Oxoacids (H + an oxoanion) are named by changing the suffix of the oxoanion: -ate becomes -ic acid and -ite becomes -ous acid. Greek numerical prefixes are used to indicate the number of atoms of each element in a compound composed of two nonmetals.

Solution:

a) blue vitriol  $\text{CuSO}_4 \cdot 5\text{H}_2\text{O}$  **copper(II) sulfate pentahydrate**

$\text{SO}_4^{2-}$  = sulfate; II is used to indicate the 2+ charge of Cu; penta- is used to indicate the 5 waters of hydration.

b) slaked lime  $\text{Ca}(\text{OH})_2$  **calcium hydroxide**

The anion  $\text{OH}^-$  is hydroxide.

c) oil of vitriol  $\text{H}_2\text{SO}_4$  **sulfuric acid**

$\text{SO}_4^{2-}$  is the sulfate ion; since this is an acid, -ate becomes -ic acid.

d) washing soda  $\text{Na}_2\text{CO}_3$  **sodium carbonate**

$\text{CO}_3^{2-}$  is the carbonate ion.

e) muriatic acid  $\text{HCl}$  **hydrochloric acid**

Binary acids (H plus one other nonmetal) are named hydro- + nonmetal root + -ic acid.

f) Epsom salts  $\text{MgSO}_4 \cdot 7\text{H}_2\text{O}$  **magnesium sulfate heptahydrate**

$\text{SO}_4^{2-}$  = sulfate; hepta- is used to indicate the 7 waters of hydration.

g) chalk  $\text{CaCO}_3$  **calcium carbonate**

$\text{CO}_3^{2-}$  is the carbonate ion.

h) dry ice  $\text{CO}_2$  **carbon dioxide**

The prefix di- indicates 2 oxygen atoms; since there is only one carbon atom, no prefix is used.

i) baking soda  $\text{NaHCO}_3$  **sodium hydrogen carbonate**

$\text{HCO}_3^-$  is the hydrogen carbonate ion.

j) lye  $\text{NaOH}$  **sodium hydroxide**

The anion  $\text{OH}^-$  is hydroxide.

- 2.82 Plan: Review the discussion on separations.

Solution:

Separating the components of a mixture requires physical methods only; that is, no chemical changes (no changes in composition) take place and the components maintain their chemical identities and properties throughout.

Separating the components of a compound requires a chemical change (change in composition).

- 2.83 Plan: Review the definitions of homogeneous and heterogeneous.

Solution:

A homogeneous mixture is uniform in its macroscopic, observable properties; a heterogeneous mixture shows obvious differences in properties (density, color, state, etc.) from one part of the mixture to another.

- 2.84 A solution (such as salt or sugar dissolved in water) is a homogeneous mixture.

- 2.85 Plan: Review the definitions of homogeneous and heterogeneous. The key is that a homogeneous mixture has a uniform composition while a heterogeneous mixture does not. A mixture consists of two or more substances physically mixed together while a compound is a pure substance.

Solution:

a) Distilled water is a **compound** that consists of  $\text{H}_2\text{O}$  molecules only.

b) Gasoline is a **homogeneous mixture** of hydrocarbon compounds of uniform composition that can be separated by physical means (distillation).

c) Beach sand is a **heterogeneous mixture** of different size particles of minerals and broken bits of shells.

- d) Wine is a **homogeneous mixture** of water, alcohol, and other compounds that can be separated by physical means (distillation).  
 e) Air is a **homogeneous mixture** of different gases, mainly N<sub>2</sub>, O<sub>2</sub>, and Ar.

2.86 Plan: Review the definitions of homogeneous and heterogeneous. The key is that a homogeneous mixture has a uniform composition while a heterogeneous mixture does not. A mixture consists of two or more substances physically mixed together while a compound is a pure substance.

Solution:

- a) Orange juice is a **heterogeneous mixture** of water, juice, and bits of orange pulp.  
 b) Vegetable soup is a **heterogeneous mixture** of water, broth, and vegetables.  
 c) Cement is a **heterogeneous mixture** of various substances.  
 d) Calcium sulfate is a **compound** of calcium, sulfur, and oxygen in a fixed proportion.  
 e) Tea is a **homogeneous mixture**.

2.87 Plan: Use the equation for the volume of a sphere in part a) to find the volume of the nucleus and the volume of the atom. Calculate the fraction of the atom volume that is occupied by the nucleus. For part b), calculate the total mass of the two electrons; subtract the electron mass from the mass of the atom to find the mass of the nucleus. Then calculate the fraction of the atom's mass contributed by the mass of the nucleus.

Solution:

$$\text{a) Volume (m}^3\text{) of nucleus} = \frac{4}{3}\pi r^3 = \frac{4}{3}\pi (2.5 \times 10^{-15} \text{ m})^3 = 6.54498 \times 10^{-44} \text{ m}^3$$

$$\text{Volume (m}^3\text{) of atom} = \frac{4}{3}\pi r^3 = \frac{4}{3}\pi (3.1 \times 10^{-11} \text{ m})^3 = 1.24788 \times 10^{-31} \text{ m}^3$$

$$\text{Fraction of volume} = \frac{\text{volume of nucleus}}{\text{volume of atom}} = \frac{6.54498 \times 10^{-44} \text{ m}^3}{1.24788 \times 10^{-31} \text{ m}^3} = 5.2449 \times 10^{-13} = \mathbf{5.2 \times 10^{-13}}$$

$$\text{b) Mass of nucleus} = \text{mass of atom} - \text{mass of electrons} \\ = 6.64648 \times 10^{-24} \text{ g} - 2(9.10939 \times 10^{-28} \text{ g}) = 6.64466 \times 10^{-24} \text{ g}$$

$$\text{Fraction of mass} = \frac{\text{mass of nucleus}}{\text{mass of atom}} = \frac{(6.64466 \times 10^{-24} \text{ g})}{(6.64648 \times 10^{-24} \text{ g})} = 0.99972617 = \mathbf{0.999726}$$

As expected, the volume of the nucleus relative to the volume of the atom is small while its relative mass is large.

2.88 Plan: Use the chemical symbols and count the atoms of each type to give a molecular formula. Use the nomenclature rules in the chapter to derive the name. These compounds are composed of two nonmetals. Greek numerical prefixes are used to indicate the number of atoms of each element in each compound. The molecular (formula) mass is the sum of the masses of each atom times its atomic mass.

Solution:

a) Formula is BrF<sub>3</sub>. When a compound is composed of two elements from the same group, the element with the higher period number is named first. The prefix tri- indicates 3 fluorine atoms. A prefix is used with the first word in the name only when more than one atom of that element is present. The name is **bromine trifluoride**.

$$\begin{array}{rclcl} \text{Br} & = & 1(79.90 \text{ amu}) & = & 79.90 \text{ amu} \\ \text{F} & = & 3(19.00 \text{ amu}) & = & \underline{57.00 \text{ amu}} \\ & & & & \mathbf{136.90 \text{ amu}} \end{array}$$

b) The formula is SCl<sub>2</sub>. The element with the lower group number is the first word in the name. The prefix di- indicates 2 chlorine atoms. A prefix is used with the first word in the name only when more than one atom of that element is present. The name is **sulfur dichloride**.

$$\begin{array}{rclcl} \text{S} & = & 1(32.07 \text{ amu}) & = & 32.07 \text{ amu} \\ \text{Cl} & = & 2(35.45 \text{ amu}) & = & \underline{70.90 \text{ amu}} \\ & & & & \mathbf{102.97 \text{ amu}} \end{array}$$

c) The formula is PCl<sub>3</sub>. The element with the lower group number is the first word in the name. The prefix tri- indicates 3 chlorine atoms. A prefix is used with the first word in the name only when more than one atom of that element is present. The name is **phosphorus trichloride**.

$$\begin{array}{rclcl}
 \text{P} & = & 1(30.97 \text{ amu}) & = & 30.97 \text{ amu} \\
 \text{Cl} & = & 3(35.45 \text{ amu}) & = & \underline{106.35 \text{ amu}} \\
 & & & & \mathbf{137.32 \text{ amu}}
 \end{array}$$

d) The formula is  $\text{N}_2\text{O}_5$ . The element with the lower group number is the first word in the name. The prefix di- indicates 2 nitrogen atoms and the prefix penta- indicates 5 oxygen atoms. Only the second element is named with the suffix -ide. The name is **dinitrogen pentoxide**.

$$\begin{array}{rclcl}
 \text{N} & = & 2(14.01 \text{ amu}) & = & 28.02 \text{ amu} \\
 \text{O} & = & 5(16.00 \text{ amu}) & = & \underline{80.00 \text{ amu}} \\
 & & & & \mathbf{108.02 \text{ amu}}
 \end{array}$$

2.89 **Plan:** Determine the percent oxygen in each oxide by subtracting the percent nitrogen from 100%. Express the percentage in amu and divide by the atomic mass of the appropriate elements. Then divide each amount by the smaller number and convert to the simplest whole-number ratio. To find the mass of oxygen per 1.00 g of nitrogen, divide the mass percentage of oxygen by the mass percentage of nitrogen.

**Solution:**

a) I  $(100.00 - 46.69 \text{ N})\% = 53.31\% \text{ O}$

$$\left( \frac{46.69 \text{ amu N}}{14.01 \text{ amu N}} \right) = 3.3326 \text{ N} \qquad \left( \frac{53.31 \text{ amu O}}{16.00 \text{ amu O}} \right) = 3.3319 \text{ O}$$

$$\frac{3.3326 \text{ N}}{3.3319} = 1.0002 \text{ N} \qquad \frac{3.3319 \text{ O}}{3.3319} = 1.0000 \text{ O}$$

The simplest whole-number ratio is **1:1 N:O**.

II  $(100.00 - 36.85 \text{ N})\% = 63.15\% \text{ O}$

$$\left( \frac{36.85 \text{ amu N}}{14.01 \text{ amu N}} \right) = 2.6303 \text{ N} \qquad \left( \frac{63.15 \text{ amu O}}{16.00 \text{ amu O}} \right) = 3.9469 \text{ O}$$

$$\frac{2.6303 \text{ N}}{2.6303} = 1.0000 \text{ mol N} \qquad \frac{3.9469 \text{ O}}{2.6303} = 1.5001 \text{ O}$$

The simplest whole-number ratio is 1:1.5 N:O = **2:3 N:O**.

III  $(100.00 - 25.94 \text{ N})\% = 74.06\% \text{ O}$

$$\left( \frac{25.94 \text{ amu N}}{14.01 \text{ amu N}} \right) = 1.8515 \text{ N} \qquad \left( \frac{74.06 \text{ amu O}}{16.00 \text{ amu O}} \right) = 4.6288 \text{ O}$$

$$\frac{1.8515 \text{ N}}{1.8515} = 1.0000 \text{ N} \qquad \frac{4.6288 \text{ O}}{1.8515} = 2.5000 \text{ O}$$

The simplest whole-number ratio is 1:2.5 N:O = **2:5 N:O**.

b) I  $\left( \frac{53.31 \text{ amu O}}{46.69 \text{ amu N}} \right) = 1.1418 = \mathbf{1.14 \text{ g O}}$

II  $\left( \frac{63.15 \text{ amu O}}{36.85 \text{ amu N}} \right) = 1.7137 = \mathbf{1.71 \text{ g O}}$

III  $\left( \frac{74.06 \text{ amu O}}{25.94 \text{ amu N}} \right) = 2.8550 = \mathbf{2.86 \text{ g O}}$

2.90 **Plan:** Recall the definitions of solid, liquid, gas (from Chapter 1), element, compound, and homogeneous and heterogeneous mixtures.

**Solution:**

a) Gas is the phase of matter that fills its container. A mixture must contain at least two different substances. B, F, G, and I each contain only one gas. **D and E** each contain a mixture; E is a mixture of two different gases while D is a mixture of a gas and a liquid of a second substance.

b) An element is a substance that cannot be broken down into simpler substances. **A, C, G, and I** are elements.

c) The solid phase has a very high resistance to flow since it has a fixed shape. **A** shows a solid element.

- d) A homogeneous mixture contains two or more substances and has only one phase. **E and H** are examples of this. E is a homogeneous mixture of two gases and H is a homogeneous mixture of two liquid substances.
- e) A liquid conforms to the container shape and forms a surface. **C** shows one element in the liquid phase.
- f) A diatomic particle is a molecule composed of two atoms. **B and G** contain diatomic molecules of gas.
- g) A compound can be broken down into simpler substances. **B and F** show molecules of a compound in the gas phase.
- h) The compound shown in **F** has molecules composed of two white atoms and one blue atom for a 2:1 atom ratio.
- i) Mixtures can be separated into the individual components by physical means. **D, E, and H** are each a mixture of two different substances.
- j) A heterogeneous mixture like **D** contains at least two different substances with a visible boundary between those substances.
- k) Compounds obey the law of definite composition. **B and F** depict compounds.

2.91 Plan: To find the mass percent divide the mass of each substance in mg by the amount of seawater in mg and multiply by 100. The percent of an ion is the mass of that ion divided by the total mass of ions.

Solution:

$$\text{a) Mass (mg) of seawater} = (1 \text{ kg}) \left( \frac{1000 \text{ g}}{1 \text{ kg}} \right) \left( \frac{1000 \text{ mg}}{1 \text{ g}} \right) = 1 \times 10^6 \text{ mg}$$

$$\text{Mass \%} = \left( \frac{\text{mass of substance}}{\text{mass of seawater}} \right) (100\%)$$

$$\text{Mass \% Cl}^- = \left( \frac{18,980 \text{ mg Cl}^-}{1 \times 10^6 \text{ mg seawater}} \right) (100\%) = \mathbf{1.898\% \text{ Cl}^-}$$

$$\text{Mass \% Na}^+ = \left( \frac{10,560 \text{ mg Na}^+}{1 \times 10^6 \text{ mg seawater}} \right) (100\%) = \mathbf{1.056\% \text{ Na}^+}$$

$$\text{Mass \% SO}_4^{2-} = \left( \frac{2650 \text{ mg SO}_4^{2-}}{1 \times 10^6 \text{ mg seawater}} \right) (100\%) = \mathbf{0.265\% \text{ SO}_4^{2-}}$$

$$\text{Mass \% Mg}^{2+} = \left( \frac{1270 \text{ mg Mg}^{2+}}{1 \times 10^6 \text{ mg seawater}} \right) (100\%) = \mathbf{0.127\% \text{ Mg}^{2+}}$$

$$\text{Mass \% Ca}^{2+} = \left( \frac{400 \text{ mg Ca}^{2+}}{1 \times 10^6 \text{ mg seawater}} \right) (100\%) = \mathbf{0.04\% \text{ Ca}^{2+}}$$

$$\text{Mass \% K}^+ = \left( \frac{380 \text{ mg K}^+}{1 \times 10^6 \text{ mg seawater}} \right) (100\%) = \mathbf{0.038\% \text{ K}^+}$$

$$\text{Mass \% HCO}_3^- = \left( \frac{140 \text{ mg HCO}_3^-}{1 \times 10^6 \text{ mg seawater}} \right) (100\%) = \mathbf{0.014\% \text{ HCO}_3^-}$$

The mass percents do not add to 100% since the majority of seawater is H<sub>2</sub>O.

$$\text{b) Total mass of ions in 1 kg of seawater} \\ = 18,980 \text{ mg} + 10,560 \text{ mg} + 2650 \text{ mg} + 1270 \text{ mg} + 400 \text{ mg} + 380 \text{ mg} + 140 \text{ mg} = 34,380 \text{ mg}$$

$$\% \text{ Na}^+ = \left( \frac{10,560 \text{ mg Na}^+}{34,380 \text{ mg total ions}} \right) (100) = 30.71553 = \mathbf{30.72\%}$$

c) Alkaline earth metal ions are Mg<sup>2+</sup> and Ca<sup>2+</sup> (Group 2 ions).

$$\text{Total mass \%} = 0.127\% \text{ Mg}^{2+} + 0.04\% \text{ Ca}^{2+} = 0.167\%$$

Alkali metal ions are Na<sup>+</sup> and K<sup>+</sup> (Group 1 ions). Total mass % = 1.056% Na<sup>+</sup> + 0.038% K<sup>+</sup> = 1.094%

$$\frac{\text{Mass \% of alkali metal ions}}{\text{Mass \% of alkaline earth metal ions}} = \frac{1.094\%}{0.167\%} = 6.6$$

Total mass percent for alkali metal ions is **6.6 times greater** than the total mass percent for alkaline earth metal ions. Sodium ions (alkali metal ions) are dominant in seawater.

d) Anions are  $\text{Cl}^-$ ,  $\text{SO}_4^{2-}$ , and  $\text{HCO}_3^-$ .

Total mass % = 1.898%  $\text{Cl}^-$  + 0.265%  $\text{SO}_4^{2-}$  + 0.014%  $\text{HCO}_3^-$  = 2.177% anions

Cations are  $\text{Na}^+$ ,  $\text{Mg}^{2+}$ ,  $\text{Ca}^{2+}$ , and  $\text{K}^+$ .

Total mass % = 1.056%  $\text{Na}^+$  + 0.127%  $\text{Mg}^{2+}$  + 0.04%  $\text{Ca}^{2+}$  + 0.038%  $\text{K}^+$  = 1.2610 = 1.26% cations

The mass fraction of **anions** is larger than the mass fraction of cations. Is the solution neutral since the mass of anions exceeds the mass of cations? Yes, although the mass is larger, the number of positive charges equals the number of negative charges.

2.92 Plan: Review the mass laws in the chapter.

Solution:

The **law of mass conservation** is illustrated in this change. The first flask has six oxygen atoms and six nitrogen atoms. The same number of each type of atom is found in both of the subsequent flasks. The mass of the substances did not change. The **law of definite composition** is also illustrated. During both temperature changes, the same compound,  $\text{N}_2\text{O}$ , was formed with the same composition.

2.93 Plan: Use the density values to convert volume of each element to mass. Find the mass ratio of Ba to S in the compound and compare that to the mass ratio present.

Solution:

For barium sulfide the barium to sulfur mass ratio is  $(137.3 \text{ g Ba}/32.07 \text{ g S}) = 4.281 \text{ g Ba/g S}$

$$\text{Mass (g) of barium} = (2.50 \text{ cm}^3 \text{ Ba}) \left( \frac{3.51 \text{ g Ba}}{1 \text{ cm}^3 \text{ Ba}} \right) = 8.775 \text{ g Ba}$$

$$\text{Mass (g) of sulfur} = (1.75 \text{ cm}^3 \text{ S}) \left( \frac{2.07 \text{ g S}}{1 \text{ cm}^3 \text{ S}} \right) = 3.6225 \text{ g S}$$

$$\text{Barium to sulfur mass ratio} = \frac{8.775 \text{ g Ba}}{3.6225 \text{ g S}} = 2.4224 = 2.42 \text{ g Ba/g S}$$

**No**, the ratio is too low; there is insufficient barium.

2.94 Plan: First, count each type of atom present to produce a molecular formula. The molecular (formula) mass is the sum of the atomic masses of all of the atoms. Divide the mass of each element in the compound by the molecular mass and multiply by 100 to obtain the mass percent of each element.

Solution:

The molecular formula of succinic acid is  $\text{C}_4\text{H}_6\text{O}_4$ .

C	=	4(12.01 amu)	=	48.04 amu
H	=	6(1.008 amu)	=	6.048 amu
O	=	4(16.00 amu)	=	<u>64.00 amu</u>
				<b>118.09 amu</b>

$$\% \text{ C} = \left( \frac{48.04 \text{ amu C}}{118.088 \text{ amu}} \right) 100\% = 40.6815 = \mathbf{40.68\% \text{ C}}$$

$$\% \text{ H} = \left( \frac{6.048 \text{ amu H}}{118.088 \text{ amu}} \right) 100\% = 5.1216 = \mathbf{5.122\% \text{ H}}$$

$$\% \text{ O} = \left( \frac{64.00 \text{ amu O}}{118.088 \text{ amu}} \right) 100\% = 54.1969 = \mathbf{54.20\% \text{ O}}$$

Check: Total =  $(40.68 + 5.122 + 54.20)\% = 100.00\%$  The answer checks.

2.95 Plan: The toxic level of fluoride ion for a 70-kg person is 0.2 g. Convert this mass to mg and use the concentration of fluoride ion in drinking water to find the volume of water that contains the toxic amount. Convert the volume of the reservoir to liters and use the concentration of 1mg of fluoride ion per liter of water to find the mass of sodium fluoride required.



Solution:

A 70-kg person would have to consume 0.2 mg of  $F^-$  to reach the toxic level.

$$\text{Mass (mg) of fluoride for a toxic level} = \left(0.2 \text{ g } F^- \right) \left( \frac{1 \text{ mg } F^-}{0.001 \text{ g } F^-} \right) = 200 \text{ mg } F^-$$

$$\text{Volume (L) of water} = \left(200 \text{ mg} \right) \left( \frac{1 \text{ L water}}{1 \text{ mg } F^-} \right) = 200 = \mathbf{2 \times 10^2 \text{ L water}}$$

$$\text{Volume (L) of reservoir} = 8.50 \times 10^7 \text{ gal} \left( \frac{4 \text{ qt}}{1 \text{ gal}} \right) \left( \frac{1 \text{ L}}{1.057 \text{ qt}} \right) = 3.26651 \times 10^8 \text{ L}$$

The molecular mass of NaF = 22.99 amu Na + 19.00 amu F = 41.99 amu. There are 19.00 mg of  $F^-$  in every 41.99 mg of NaF.

$$\begin{aligned} \text{Mass (kg) of NaF} &= \left(3.216651 \times 10^8 \text{ L} \right) \left( \frac{1 \text{ mg } F^-}{1 \text{ L } H_2O} \right) \left( \frac{41.99 \text{ mg NaF}}{19.00 \text{ mg } F^-} \right) \left( \frac{10^{-3} \text{ g}}{1 \text{ mg}} \right) \left( \frac{1 \text{ kg NaF}}{10^3 \text{ g NaF}} \right) \\ &= 710.88 = \mathbf{711 \text{ kg NaF}} \end{aligned}$$

- 2.96 Plan:  $Z$  = the atomic number of the element.  $A$  is the mass number. To find the percent abundance of each Sb isotope, let  $x$  equal the fractional abundance of one isotope and  $(1 - x)$  equal the fractional abundance of the second isotope since the sum of the fractional abundances must equal 1. Remember that atomic mass = (isotopic mass of the first isotope  $\times$  fractional abundance) + (isotopic mass of the second isotope  $\times$  fractional abundance).

Solution:

a) Antimony is element 51 so  $Z = 51$ . Isotope of mass 120.904 amu has a mass number of 121:  $^{121}_{51}\text{Sb}$

Isotope of mass 122.904 amu has a mass number of 123:  $^{123}_{51}\text{Sb}$

b) Let  $x$  = fractional abundance of antimony-121. This makes the fractional abundance of antimony-123 =  $1 - x$

$$x(120.904 \text{ amu}) + (1 - x)(122.904 \text{ amu}) = 121.8 \text{ amu}$$

$$120.904 \text{ amu}(x) + 122.904 \text{ amu} - 122.904 \text{ amu}(x) = 121.8 \text{ amu}$$

$$2x = 1.104$$

$$x = 0.552 = \mathbf{0.55 \text{ fraction of antimony-121}}$$

$$1 - x = 1 - 0.552 = \mathbf{0.45 \text{ fraction of antimony-123}}$$

- 2.97 Plan: List all possible combinations of the isotopes. Determine the masses of each isotopic composition. The molecule consisting of the lower abundance isotopes (N-15 and O-18) is the least common, and the one containing only the more abundant isotopes (N-14 and O-16) will be the most common.

Solution:

a)

Formula

$^{15}\text{N}_2^{18}\text{O}$

$^{15}\text{N}_2^{16}\text{O}$

$^{14}\text{N}_2^{18}\text{O}$

$^{14}\text{N}_2^{16}\text{O}$

$^{15}\text{N}^{14}\text{N}^{18}\text{O}$

$^{15}\text{N}^{14}\text{N}^{16}\text{O}$

Mass (amu)

$$2(15 \text{ amu N}) + 18 \text{ amu O} = \mathbf{48}$$

$$2(15 \text{ amu N}) + 16 \text{ amu O} = \mathbf{46}$$

$$2(14 \text{ amu N}) + 18 \text{ amu O} = \mathbf{46}$$

$$2(14 \text{ amu N}) + 16 \text{ amu O} = \mathbf{44}$$

$$1(15 \text{ amu N}) + 1(14 \text{ amu N}) + 18 \text{ amu O} = \mathbf{47}$$

$$1(15 \text{ amu N}) + 1(14 \text{ amu N}) + 16 \text{ amu O} = \mathbf{45}$$

b)

**least common**

**most common**

- 2.98 Plan: Review the information about the periodic table in the chapter.

Solution:

a) Nonmetals are located in the upper-right portion of the periodic table: **Black, red, green, and purple**

b) Metals are located in the large left portion of the periodic table: **Brown and blue**

c) Some nonmetals, such as oxygen, chlorine, and argon, are gases: **Red, green, and purple**

d) Most metals, such as sodium and barium are solids; carbon is a solid: **Brown, blue, and black**

e) Nonmetals form covalent compounds; most noble gases do not form compounds:

**Black and red or black and green or red and green**

f) Nonmetals form covalent compounds; most noble gases do not form compounds:

**Black and red or black and green or red and green**

g) Metals react with nonmetals to form ionic compounds. For a compound with a formula of MX, the ionic charges of the metals and nonmetal must be equal in magnitude like Na<sup>+</sup> and Cl<sup>-</sup> or Ba<sup>2+</sup> and O<sup>2-</sup>: **Brown and green or blue and red**

h) Metals react with nonmetals to form ionic compounds. For a compound with a formula of MX, the ionic charges of the metals and nonmetal must be equal in magnitude like Na<sup>+</sup> and Cl<sup>-</sup> or Ba<sup>2+</sup> and O<sup>2-</sup>: **Brown and green or blue and red**

i) Metals react with nonmetals to form ionic compounds. For a compound with a formula of M<sub>2</sub>X, the ionic charge of the nonmetal must be twice as large as that of the metal like Na<sup>+</sup> and O<sup>2-</sup> or Ba<sup>2+</sup> and C<sup>4-</sup>: **Brown and red or blue and black**

j) Metals react with nonmetals to form ionic compounds. For a compound with a formula of MX<sub>2</sub>, the ionic charge of the metal must be twice as large as that of the nonmetal like Ba<sup>2+</sup> and Cl<sup>-</sup>: **Blue and green**

k) Most Group 8A(18) elements are unreactive: **Purple**

l) Different compounds often exist between the same two nonmetal elements. Since oxygen exists as O<sup>2-</sup> or O<sub>2</sub><sup>2-</sup>, metals can sometimes form more than one compound with oxygen: **Black and red or red and green or black and green or brown and red or blue and red**

2.99 Plan: Convert the mass of compound in mg to kg and use the absolute mass of the atomic mass unit to find the number of amu of compound. Divide by the formula mass of the compound to obtain molecules of compound and then number of As atoms. To find mass percent of metal, divide the atomic mass of the metal by the total mass of metal-dimercaprol complex and multiply by 100.

Solution:

$$\text{a) As atoms} = (250. \text{ mg dimercaprol}) \left( \frac{10^{-3} \text{ g}}{1 \text{ mg}} \right) \left( \frac{1 \text{ kg}}{10^3 \text{ g}} \right) \left( \frac{1 \text{ amu}}{1.66054 \times 10^{-27} \text{ kg}} \right) \left( \frac{1 \text{ dimercaprol}}{124.23 \text{ amu}} \right) \left( \frac{1 \text{ As atom}}{1 \text{ dimercaprol}} \right)$$
$$= 1.2119 \times 10^{21} \text{ As atoms} = \mathbf{1.21 \times 10^{21} \text{ As atoms}}$$

$$\text{b) Mass \% Hg} = \frac{200.6 \text{ amu}}{(200.6 + 124.23) \text{ amu}} \times 100\% = 61.7554 = \mathbf{61.76\% \text{ Hg}}$$

$$\text{Mass \% Tl} = \frac{204.4 \text{ amu}}{(204.4 + 124.23) \text{ amu}} \times 100\% = 62.1976 = \mathbf{62.20\% \text{ Tl}}$$

$$\text{Mass \% Cr} = \frac{52.00 \text{ amu}}{(52.00 + 124.23) \text{ amu}} \times 100\% = 29.5069 = \mathbf{29.51\% \text{ Cr}}$$

2.100 Plan: Use Coulomb's Law which states that the energy of attraction in an ionic bond is directly proportional to the *product of charges* and inversely proportional to the *distance between charges*. The strongest ionic bonding occurs between ions with the largest ionic charges and the smallest radii.

Solution:

Of the cations, Mg<sup>2+</sup> and Ba<sup>2+</sup> have the largest ionic charges but Mg<sup>2+</sup> is significantly smaller (72 pm vs 135 pm); pairing Mg<sup>2+</sup> with the anion with the largest charge, O<sup>2-</sup>, would give the strongest ionic bond: **Mg<sup>2+</sup> and O<sup>2-</sup>**.

The weakest ionic bonding occurs between ions with the smallest ionic charges and the largest radii. Choose the largest +1 cation, Rb<sup>+</sup> (152 pm) and the largest -1 anion, I<sup>-</sup> (220 pm): **Rb<sup>+</sup> and I<sup>-</sup>**.

2.101 Plan: First, determine the fraction of each element in each mineral by dividing the total atomic mass of element by the total molecular mass of the mineral. The percent mass of each element in the rock can be found by multiplying the mass fraction of each element in each mineral by the mass fraction of that mineral in the rock and then multiplying by 100.

Solution:

Molecular mass of Fe<sub>2</sub>SiO<sub>4</sub> = 2(55.85 amu) + 28.09 amu + 4(16.00 amu) = 203.79 amu

$$\text{Mass fraction of Fe} = \frac{2(55.85 \text{ amu})}{203.79 \text{ amu}} = 0.5481$$

$$\text{Mass fraction of Si} = \frac{28.09 \text{ amu}}{203.79 \text{ amu}} = 0.1378$$

$$\text{Mass fraction of O} = \frac{4(16.00 \text{ amu})}{203.79 \text{ amu}} = 0.3140$$

$$\text{Molecular mass of Mg}_2\text{SiO}_4 = 2(24.31 \text{ amu}) + 28.09 \text{ amu} + 4(16.00 \text{ amu}) = 140.71 \text{ amu}$$

$$\text{Mass fraction of Mg} = \frac{2(24.31 \text{ amu})}{140.71 \text{ amu}} = 0.3455$$

$$\text{Mass fraction of Si} = \frac{28.09 \text{ amu}}{140.71 \text{ amu}} = 0.1996$$

$$\text{Mass fraction of O} = \frac{4(16.00 \text{ amu})}{140.71 \text{ amu}} = 0.4548$$

$$\text{Molecular mass of SiO}_2 = 28.09 \text{ amu} + 2(16.00 \text{ amu}) = 60.09 \text{ amu}$$

$$\text{Mass fraction of Si} = \frac{28.09 \text{ amu}}{60.09 \text{ amu}} = 0.4675$$

$$\text{Mass fraction of O} = \frac{2(16.00 \text{ amu})}{60.09 \text{ amu}} = 0.5325$$

$$\text{Mass percent Fe} = (0.050)(0.5481)(100\%) = \mathbf{2.7\% \text{ Fe}}$$

$$\text{Mass percent Mg} = (0.070)(0.3455)(100\%) = \mathbf{2.4\% \text{ Mg}}$$

$$\text{Mass percent Si} = [(0.050)(0.1378) + (0.070)(0.1996) + (0.880)(0.4675)](100\%) = \mathbf{43.2\% \text{ Si}}$$

$$\text{Mass percent O} = [(0.050)(0.3140) + (0.070)(0.4548) + (0.880)(0.5325)](100\%) = \mathbf{51.6\% \text{ O}}$$

- 2.102 Plan: To find the formula mass of potassium fluoride, add the atomic masses of potassium and fluorine. Fluorine has only one naturally occurring isotope, so the mass of this isotope equals the atomic mass of fluorine. The atomic mass of potassium is the weighted average of the two isotopic masses: (isotopic mass of isotope 1 x fractional abundance) + (isotopic mass of isotope 2 x fractional abundance).

Solution:

Average atomic mass of K =

$$(\text{isotopic mass of } ^{39}\text{K} \times \text{fractional abundance}) + (\text{isotopic mass of } ^{41}\text{K} \times \text{fractional abundance})$$

$$\text{Average atomic mass of K} = (38.9637 \text{ amu})\left(\frac{93.258\%}{100\%}\right) + (40.9618 \text{ amu})\left(\frac{6.730\%}{100\%}\right) = 39.093 \text{ amu}$$

The formula for potassium fluoride is KF, so its molecular mass is (39.093 + 18.9984) = **58.091 amu**

- 2.103 Plan: One molecule of NO is released per atom of N in the medicine. Divide the total mass of NO released by the molecular mass of the medicine and multiply by 100 for mass percent.

Solution:

$$\text{NO} = (14.01 + 16.00) \text{ amu} = 30.01 \text{ amu}$$

Nitroglycerin:

$$\text{C}_3\text{H}_5\text{N}_3\text{O}_9 = 3(12.01 \text{ amu C}) + 5(1.008 \text{ amu H}) + 3(14.01 \text{ amu N}) + 9(16.00 \text{ amu O}) = 227.10 \text{ amu}$$

In  $\text{C}_3\text{H}_5\text{N}_3\text{O}_9$  (molecular mass = 227.10 amu), there are 3 atoms of N; since 1 molecule of NO is released per atom of N, this medicine would release 3 molecules of NO. The molecular mass of NO = 30.01 amu.

$$\text{Mass percent of NO} = \frac{\text{total mass of NO}}{\text{mass of compound}}(100) = \frac{3(30.01 \text{ amu})}{227.10 \text{ amu}}(100) = 39.6433 = \mathbf{39.64\%}$$

Isoamyl nitrate:

$$\text{C}_5\text{H}_{11}\text{NO}_3 = 5(12.01 \text{ amu C}) + 11(1.008 \text{ amu H}) + 1(14.01 \text{ amu N}) + 3(16.00 \text{ amu O}) = 133.15 \text{ amu}$$

In  $(\text{CH}_3)_2\text{CHCH}_2\text{CH}_2\text{ONO}_2$  (molecular mass = 133.15 amu), there is one atom of N; since 1 molecule of NO is released per atom of N, this medicine would release 1 molecule of NO.

$$\text{Mass percent of NO} = \frac{\text{total mass of NO}}{\text{mass of compound}}(100) = \frac{1(30.01 \text{ amu})}{133.15 \text{ amu}}(100) = 22.5385 = \mathbf{22.54\%}$$

2.104 **Plan:** First, count each type of atom present to produce a molecular formula. Determine the mass fraction of each element. Mass fraction =  $\frac{\text{total mass of the element}}{\text{molecular mass of TNT}}$ . The mass of TNT multiplied by the mass fraction of each element gives the mass of that element.

**Solution:**

The molecular formula for TNT is  $C_7H_5O_6N_3$ . The molecular mass of TNT is:

$$\begin{array}{rclcl} C & = & 7(12.01 \text{ amu}) & = & 84.07 \text{ amu} \\ H & = & 5(1.008 \text{ amu}) & = & 5.040 \text{ amu} \\ O & = & 6(16.00 \text{ amu}) & = & 96.00 \text{ amu} \\ N & = & 3(14.01 \text{ amu}) & = & \underline{42.03 \text{ amu}} \\ & & & & 227.14 \text{ amu} \end{array}$$

The mass fraction of each element is:

$$C = \frac{84.07 \text{ amu}}{227.14 \text{ amu}} = 0.3701 \text{ C} \qquad H = \frac{5.040 \text{ amu}}{227.14 \text{ amu}} = 0.02219 \text{ H}$$

$$O = \frac{96.00 \text{ amu}}{227.14 \text{ amu}} = 0.4226 \text{ O} \qquad N = \frac{42.03 \text{ amu}}{227.14 \text{ amu}} = 0.1850 \text{ N}$$

Masses of each element in 1.00 lb of TNT = mass fraction of element x 1.00 lb.

$$\text{Mass (lb) C} = 0.3701 \times 1.00 \text{ lb} = \mathbf{0.370 \text{ lb C}}$$

$$\text{Mass (lb) H} = 0.02219 \times 1.00 \text{ lb} = \mathbf{0.0222 \text{ lb H}}$$

$$\text{Mass (lb) O} = 0.4226 \times 1.00 \text{ lb} = \mathbf{0.423 \text{ lb O}}$$

$$\text{Mass (lb) N} = 0.1850 \times 1.00 \text{ lb} = \mathbf{0.185 \text{ lb N}}$$

2.105 **Plan:** Determine the mass percent of platinum by dividing the mass of Pt in the compound by the molecular mass of the compound and multiplying by 100. For part b), divide the total amount of money available by the cost of Pt per gram to find the mass of Pt that can be purchased. Use the mass percent of Pt to convert from mass of Pt to mass of compound.

**Solution:**

a) The molecular formula for platinum is  $Pt(NH_3)_2Cl_2$ . Its molecular mass is:

$$\begin{array}{rclcl} Pt & = & 1(195.1 \text{ amu}) & = & 195.1 \text{ amu} \\ N & = & 2(14.01 \text{ amu}) & = & 28.02 \text{ amu} \\ H & = & 6(1.008 \text{ amu}) & = & 6.048 \text{ amu} \\ Cl & = & 2(35.45 \text{ amu}) & = & \underline{70.90 \text{ amu}} \\ & & & & 300.1 \text{ amu} \end{array}$$

$$\text{Mass \% Pt} = \frac{\text{mass of Pt}}{\text{molecular mass of compound}}(100) = \frac{195.1 \text{ amu}}{300.1 \text{ amu}}(100) = 65.012 = \mathbf{65.01\% \text{ Pt}}$$

$$\text{b) Mass (g) of Pt} = (\$1.00 \times 10^6) \left( \frac{1 \text{ g Pt}}{\$32} \right) = 31,250 \text{ g Pt}$$

$$\text{Mass (g) of platinum} = (31,250 \text{ g Pt}) \left( \frac{100 \text{ g platinum}}{65.01 \text{ g Pt}} \right) = 4.8070 \times 10^4 = \mathbf{4.8 \times 10^4 \text{ g platinum}}$$

2.106 **Plan:** A change is physical when there has been a change in physical form but not a change in composition. In a chemical change, a substance is converted into a different substance.

**Solution:**

1) Initially, all the molecules are present in blue-blue or red-red pairs. After the change, there are no red-red pairs, and there are now red-blue pairs. Changing some of the pairs means there has been a **chemical change**.

2) There are two blue-blue pairs and four red-blue pairs both before and after the change, thus no chemical change occurred. The different types of molecules are separated into different boxes. This is a **physical change**.

3) The identity of the box contents has changed from pairs to individuals. This requires a **chemical change**.

4) The contents have changed from all pairs to all triplets. This is a change in the identity of the particles, thus, this is a **chemical change**.

5) There are four red-blue pairs both before and after, thus there has been no change in the identity of the individual units. There has been a **physical change**.

# CHAPTER 3 STOICHIOMETRY OF FORMULAS AND EQUATIONS

## END-OF-CHAPTER PROBLEMS

- 3.1 Plan: The atomic mass of an element expressed in amu is numerically the same as the mass of 1 mole of the element expressed in grams. We know the moles of each element and have to find the mass (in g). To convert moles of element to grams of element, multiply the number of moles by the molar mass of the element.

Solution:

Al 26.98 amu  $\equiv$  26.98 g/mol Al

$$\text{Mass Al (g)} = (3 \text{ mol Al}) \left( \frac{26.98 \text{ g Al}}{1 \text{ mol Al}} \right) = \mathbf{80.94 \text{ g Al}}$$

Cl 35.45 amu  $\equiv$  35.45 g/mol Cl

$$\text{Mass Cl (g)} = (2 \text{ mol Cl}) \left( \frac{35.45 \text{ g Cl}}{1 \text{ mol Cl}} \right) = \mathbf{70.90 \text{ g Cl}}$$

- 3.2 Plan: The molecular formula of sucrose tells us that 1 mole of sucrose contains 12 moles of carbon atoms. Multiply the moles of sucrose by 12 to obtain moles of carbon atoms; multiply the moles of carbon atoms by Avogadro's number to convert from moles to atoms.

Solution:

$$\text{a) Moles of C atoms} = (1 \text{ mol C}_{12}\text{H}_{22}\text{O}_{11}) \left( \frac{12 \text{ mol C}}{1 \text{ mol C}_{12}\text{H}_{22}\text{O}_{11}} \right) = \mathbf{12 \text{ mol C}}$$

$$\text{b) C atoms} = (2 \text{ mol C}_{12}\text{H}_{22}\text{O}_{11}) \left( \frac{12 \text{ mol C}}{1 \text{ mol C}_{12}\text{H}_{22}\text{O}_{11}} \right) \left( \frac{6.022 \times 10^{23} \text{ C atoms}}{1 \text{ mol C}} \right) = \mathbf{1.445 \times 10^{25} \text{ C atoms}}$$

- 3.3 Plan: Review the list of elements that exist as diatomic or polyatomic molecules.

Solution:

"1 mol of chlorine" could be interpreted as a mole of chlorine atoms or a mole of chlorine molecules, Cl<sub>2</sub>. Specify which to avoid confusion. The same problem is possible with other diatomic or polyatomic molecules, e.g., F<sub>2</sub>, Br<sub>2</sub>, I<sub>2</sub>, H<sub>2</sub>, O<sub>2</sub>, N<sub>2</sub>, S<sub>8</sub>, and P<sub>4</sub>. For these elements, as for chlorine, it is not clear if atoms or molecules are being discussed.

- 3.4 The molecular mass is the sum of the atomic masses of the atoms or ions in a molecule. The molar mass is the mass of 1 mole of a chemical entity. Both will have the same numeric value for a given chemical substance but molecular mass will have the units of amu and molar mass will have the units of g/mol.
- 3.5 A mole of a particular substance represents a fixed number of chemical entities and has a fixed mass. Therefore the mole gives us an easy way to determine the number of particles (atoms, molecules, etc.) in a sample by weighing it. The mole maintains the same mass relationship between macroscopic samples as exist between individual chemical entities. It relates the number of chemical entities (atoms, molecules, ions, electrons) to the mass.
- 3.6 Plan: The relative atomic masses of each element can be found by counting the number of atoms of each element and comparing the overall masses of the two samples.

Solution:

a) Balance A: The element on the **left** (green) has the higher molar mass because only 5 green balls are necessary to counterbalance the mass of 6 yellow balls. Since the green ball is heavier, its atomic mass is larger, and therefore its molar mass is larger. Balance B: The element on the **right** (blue) has the higher molar mass since 3 blue balls are heavier than 6 red balls. Since the blue ball is heavier, its atomic mass is larger, and therefore its

molar mass is larger. Balance C: The element on the **left** (orange) has the higher molar mass because 5 orange balls are heavier than 5 purple balls. Since the orange ball is heavier, its atomic mass is larger, and therefore its molar mass is larger. Balance D: The element on the **left** (gray) has the higher molar mass because only 5 gray balls are necessary to counterbalance the mass of 7 red balls. Since the gray ball is heavier, its atomic mass is larger, and therefore its molar mass is larger.

b) The elements on the **right** in Balances A, C, and D have more atoms per gram. The element on the right in each of these balances is lighter. Because these elements are lighter, more atoms are required to make 1 g. In Balance B, the element on the **left** is lighter and would therefore require more atoms to make 1 g.

c) The elements on the **left** in Balances A, C, and D have fewer atoms per gram. Atoms of these elements are heavier, and it takes fewer balls to make 1 g. In Balance B, the element on the **right** is heavier and therefore has fewer atoms per gram.

d) **Neither** element on any of the balances has more atoms per mole. Both the left and right elements have the same number of atoms per mole. The number of atoms per mole ( $6.022 \times 10^{23}$ ) is constant and so is the same for every element.

3.7 Plan: Locate each of the elements on the periodic table and record its atomic mass. The atomic mass of the element multiplied by the number of atoms present in the formula gives the mass of that element in one mole of the substance. The molar mass is the sum of the masses of the elements in the substance expressed in g/mol.

Solution:

$$\begin{aligned} \text{a) } \mathcal{M} &= (1 \times \mathcal{M} \text{ of Sr}) + (2 \times \mathcal{M} \text{ of O}) + (2 \times \mathcal{M} \text{ of H}) \\ &= (1 \times 87.62 \text{ g/mol Sr}) + (2 \times 16.00 \text{ g/mol O}) + (2 \times 1.008 \text{ g/mol H}) \\ &= \mathbf{121.64 \text{ g/mol of Sr(OH)}_2} \end{aligned}$$

$$\begin{aligned} \text{b) } \mathcal{M} &= (2 \times \mathcal{M} \text{ of N}) + (3 \times \mathcal{M} \text{ of O}) \\ &= (2 \times 14.01 \text{ g/mol N}) + (3 \times 16.00 \text{ g/mol O}) \\ &= \mathbf{76.02 \text{ g/mol of N}_2\text{O}_3} \end{aligned}$$

$$\begin{aligned} \text{c) } \mathcal{M} &= (1 \times \mathcal{M} \text{ of Na}) + (1 \times \mathcal{M} \text{ of Cl}) + (3 \times \mathcal{M} \text{ of O}) \\ &= (1 \times 22.99 \text{ g/mol Na}) + (1 \times 35.45 \text{ g/mol Cl}) + (3 \times 16.00 \text{ g/mol O}) \\ &= \mathbf{106.44 \text{ g/mol of NaClO}_3} \end{aligned}$$

$$\begin{aligned} \text{d) } \mathcal{M} &= (2 \times \mathcal{M} \text{ of Cr}) + (3 \times \mathcal{M} \text{ of O}) \\ &= (2 \times 52.00 \text{ g/mol Cr}) + (3 \times 16.00 \text{ g/mol O}) \\ &= \mathbf{152.00 \text{ g/mol of Cr}_2\text{O}_3} \end{aligned}$$

3.8 Plan: Locate each of the elements on the periodic table and record its atomic mass. The atomic mass of the element multiplied by the number of atoms present in the formula gives the mass of that element in one mole of the substance. The molar mass is the sum of the masses of the elements in the substance expressed in g/mol.

Solution:

$$\begin{aligned} \text{a) } \mathcal{M} &= (3 \times \mathcal{M} \text{ of N}) + (12 \times \mathcal{M} \text{ of H}) + (1 \times \mathcal{M} \text{ of P}) + (4 \times \mathcal{M} \text{ of O}) \\ &= (3 \times 14.01 \text{ g/mol N}) + (12 \times 1.008 \text{ g/mol H}) + (1 \times 30.97 \text{ g/mol P}) + (4 \times 16.00 \text{ g/mol O}) \\ &= \mathbf{149.10 \text{ g/mol of (NH}_4)_3\text{PO}_4} \end{aligned}$$

$$\begin{aligned} \text{b) } \mathcal{M} &= (1 \times \mathcal{M} \text{ of C}) + (2 \times \mathcal{M} \text{ of H}) + (2 \times \mathcal{M} \text{ of Cl}) \\ &= (1 \times 12.01 \text{ g/mol C}) + (2 \times 1.008 \text{ g/mol H}) + (2 \times 35.45 \text{ g/mol Cl}) \\ &= \mathbf{84.93 \text{ g/mol of CH}_2\text{Cl}_2} \end{aligned}$$

$$\begin{aligned} \text{c) } \mathcal{M} &= (1 \times \mathcal{M} \text{ of Cu}) + (1 \times \mathcal{M} \text{ of S}) + (9 \times \mathcal{M} \text{ of O}) + (10 \times \mathcal{M} \text{ of H}) \\ &= (1 \times 63.55 \text{ g/mol Cu}) + (1 \times 32.07 \text{ g/mol S}) + (9 \times 16.00 \text{ g/mol O}) + (10 \times 1.008 \text{ g/mol H}) \\ &= \mathbf{249.70 \text{ g/mol of CuSO}_4 \cdot 5\text{H}_2\text{O}} \end{aligned}$$

$$\begin{aligned} \text{d) } \mathcal{M} &= (1 \times \mathcal{M} \text{ of Br}) + (3 \times \mathcal{M} \text{ of F}) \\ &= (1 \times 79.90 \text{ g/mol Br}) + (3 \times 19.00 \text{ g/mol F}) \\ &= \mathbf{136.90 \text{ g/mol of BrF}_3} \end{aligned}$$

3.9 Plan: Locate each of the elements on the periodic table and record its atomic mass. The atomic mass of the element multiplied by the number of atoms present in the formula gives the mass of that element in one mole of the substance. The molar mass is the sum of the masses of the elements in the substance expressed in g/mol.

Solution:

- a)  $\mathcal{M} = (1 \times \mathcal{M} \text{ of Sn}) + (1 \times \mathcal{M} \text{ of O})$   
 $= (1 \times 118.7 \text{ g/mol Sn}) + (1 \times 16.00 \text{ g/mol O})$   
 $= \mathbf{134.7 \text{ g/mol of SnO}}$
- b)  $\mathcal{M} = (1 \times \mathcal{M} \text{ of Ba}) + (2 \times \mathcal{M} \text{ of F})$   
 $= (1 \times 137.3 \text{ g/mol Ba}) + (2 \times 19.00 \text{ g/mol F})$   
 $= \mathbf{175.3 \text{ g/mol of BaF}_2}$
- c)  $\mathcal{M} = (2 \times \mathcal{M} \text{ of Al}) + (3 \times \mathcal{M} \text{ of S}) + (12 \times \mathcal{M} \text{ of O})$   
 $= (2 \times 26.98 \text{ g/mol Al}) + (3 \times 32.07 \text{ g/mol S}) + (12 \times 16.00 \text{ g/mol O})$   
 $= \mathbf{342.17 \text{ g/mol of Al}_2(\text{SO}_4)_3}$
- d)  $\mathcal{M} = (1 \times \mathcal{M} \text{ of Mn}) + (2 \times \mathcal{M} \text{ of Cl})$   
 $= (1 \times 54.94 \text{ g/mol Mn}) + (2 \times 35.45 \text{ g/mol Cl})$   
 $= \mathbf{125.84 \text{ g/mol of MnCl}_2}$

- 3.10 Plan: Locate each of the elements on the periodic table and record its atomic mass. The atomic mass of the element multiplied by the number of atoms present in the formula gives the mass of that element in one mole of the substance. The molar mass is the sum of the masses of the elements in the substance expressed in g/mol.

Solution:

- a)  $\mathcal{M} = (2 \times \mathcal{M} \text{ of N}) + (4 \times \mathcal{M} \text{ of O})$   
 $= (2 \times 14.01 \text{ g/mol N}) + (4 \times 16.00 \text{ g/mol O})$   
 $= \mathbf{92.02 \text{ g/mol of N}_2\text{O}_4}$
- b)  $\mathcal{M} = (4 \times \mathcal{M} \text{ of C}) + (10 \times \mathcal{M} \text{ of H}) + (1 \times \mathcal{M} \text{ of O})$   
 $= (4 \times 12.01 \text{ g/mol C}) + (10 \times 1.008 \text{ g/mol H}) + (1 \times 16.00 \text{ g/mol O})$   
 $= \mathbf{74.12 \text{ g/mol of C}_4\text{H}_{10}\text{O}}$
- c)  $\mathcal{M} = (1 \times \mathcal{M} \text{ of Mg}) + (1 \times \mathcal{M} \text{ of S}) + (11 \times \mathcal{M} \text{ of O}) + (14 \times \mathcal{M} \text{ of H})$   
 $= (1 \times 24.31 \text{ g/mol Mg}) + (1 \times 32.07 \text{ g/mol S}) + (11 \times 16.00 \text{ g/mol O}) + (14 \times 1.008 \text{ g/mol H})$   
 $= \mathbf{246.49 \text{ g/mol of MgSO}_4 \cdot 7\text{H}_2\text{O}}$
- d)  $\mathcal{M} = (1 \times \mathcal{M} \text{ of Ca}) + (4 \times \mathcal{M} \text{ of C}) + (6 \times \mathcal{M} \text{ of H}) + (4 \times \mathcal{M} \text{ of O})$   
 $= (1 \times 40.08 \text{ g/mol Ca}) + (4 \times 12.01 \text{ g/mol C}) + (6 \times 1.008 \text{ g/mol H}) + (4 \times 16.00 \text{ g/mol O})$   
 $= \mathbf{158.17 \text{ g/mol of Ca(C}_2\text{H}_3\text{O}_2)_2}$

- 3.11 Plan: Determine the molar mass of each substance, then perform the appropriate molar conversions. To find the mass in part a), multiply the number of moles by the molar mass of the substance. In part b), first convert mass of compound to moles of compound by dividing by the molar mass of the compound. The molecular formula of the compound tells us that 1 mole of compound contains 6 moles of oxygen atoms; use the 1:6 ratio to convert moles of compound to moles of oxygen atoms. In part c), convert mass of compound to moles of compound by dividing by the molar mass of the compound. Since 1 mole of compound contains 6 moles of oxygen atoms, multiply the moles of compound by 6 to obtain moles of oxygen atoms; then multiply by Avogadro's number to obtain the number of oxygen atoms.

Solution:

- a)  $\mathcal{M} \text{ of KMnO}_4 = (1 \times \mathcal{M} \text{ of K}) + (1 \times \mathcal{M} \text{ of Mn}) + (4 \times \mathcal{M} \text{ of O})$   
 $= (1 \times 39.10 \text{ g/mol K}) + (1 \times 54.94 \text{ g/mol Mn}) + (4 \times 16.00 \text{ g/mol O}) = 158.04 \text{ g/mol of KMnO}_4$   
 $\text{Mass of KMnO}_4 = (0.68 \text{ mol KMnO}_4) \left( \frac{158.04 \text{ g KMnO}_4}{1 \text{ mol KMnO}_4} \right) = 107.467 = \mathbf{1.1 \times 10^2 \text{ g KMnO}_4}$
- b)  $\mathcal{M} \text{ of Ba(NO}_3)_2 = (1 \times \mathcal{M} \text{ of Ba}) + (2 \times \mathcal{M} \text{ of N}) + (6 \times \mathcal{M} \text{ of O})$   
 $= (1 \times 137.3 \text{ g/mol Ba}) + (2 \times 14.01 \text{ g/mol N}) + (6 \times 16.00 \text{ g/mol O}) = 261.3 \text{ g/mol Ba(NO}_3)_2$   
 $\text{Moles of Ba(NO}_3)_2 = (8.18 \text{ g Ba(NO}_3)_2) \left( \frac{1 \text{ mol Ba(NO}_3)_2}{261.3 \text{ g Ba(NO}_3)_2} \right) = 0.031305 \text{ mol Ba(NO}_3)_2$   
 $\text{Moles of O atoms} = (0.031305 \text{ mol Ba(NO}_3)_2) \left( \frac{6 \text{ mol O atoms}}{1 \text{ mol Ba(NO}_3)_2} \right) = 0.18783 = \mathbf{0.188 \text{ mol O atoms}}$
- c)  $\mathcal{M} \text{ of CaSO}_4 \cdot 2\text{H}_2\text{O} = (1 \times \mathcal{M} \text{ of Ca}) + (1 \times \mathcal{M} \text{ of S}) + (6 \times \mathcal{M} \text{ of O}) + (4 \times \mathcal{M} \text{ of H})$   
 $= (1 \times 40.08 \text{ g/mol Ca}) + (1 \times 32.07 \text{ g/mol S}) + (6 \times 16.00 \text{ g/mol O}) + (4 \times 1.008 \text{ g/mol H})$   
 $= 172.18 \text{ g/mol}$

(Note that the waters of hydration are included in the molar mass.)

$$\text{Moles of CaSO}_4 \cdot 2\text{H}_2\text{O} = \left(7.3 \times 10^{-3} \text{ g CaSO}_4 \cdot 2\text{H}_2\text{O}\right) \left(\frac{1 \text{ mol CaSO}_4 \cdot 2\text{H}_2\text{O}}{172.18 \text{ g CaSO}_4 \cdot 2\text{H}_2\text{O}}\right) = 4.239749 \times 10^{-5} \text{ mol}$$

$$\begin{aligned} \text{Moles of O atoms} &= \left(4.239749 \times 10^{-5} \text{ mol CaSO}_4 \cdot 2\text{H}_2\text{O}\right) \left(\frac{6 \text{ mol O atoms}}{1 \text{ mol CaSO}_4 \cdot 2\text{H}_2\text{O}}\right) \\ &= 2.54385 \times 10^{-5} \text{ mol O atoms} \end{aligned}$$

$$\begin{aligned} \text{Number of O atoms} &= \left(2.54385 \times 10^{-5} \text{ mol O atoms}\right) \left(\frac{6.022 \times 10^{23} \text{ O atoms}}{1 \text{ mol O atoms}}\right) \\ &= 1.5319 \times 10^{20} = \mathbf{1.5 \times 10^{20} \text{ O atoms}} \end{aligned}$$

3.12 Plan: Determine the molar mass of each substance, then perform the appropriate molar conversions.

To find the mass in part a), divide the number of molecules by Avogadro's number to find moles of compound and then multiply the mole amount by the molar mass in grams; convert from mass in g to mass in kg. In part b), first convert mass of compound to moles of compound by dividing by the molar mass of the compound. The molecular formula of the compound tells us that 1 mole of compound contains 2 moles of chlorine atoms; use the 1:2 ratio to convert moles of compound to moles of chlorine atoms. In part c), convert mass of compound to moles of compound by dividing by the molar mass of the compound. Since 1 mole of compound contains 2 moles of  $\text{H}^-$  ions, multiply the moles of compound by 2 to obtain moles of  $\text{H}^-$  ions; then multiply by Avogadro's number to obtain the number of  $\text{H}^-$  ions.

Solution:

$$\begin{aligned} \text{a) } \mathcal{M} \text{ of NO}_2 &= (1 \times \mathcal{M} \text{ of N}) + (2 \times \mathcal{M} \text{ of O}) \\ &= (1 \times 14.01 \text{ g/mol N}) + (2 \times 16.00 \text{ g/mol O}) = 46.01 \text{ g/mol of NO}_2 \end{aligned}$$

$$\text{Moles of NO}_2 = \left(4.6 \times 10^{21} \text{ molecules NO}_2\right) \left(\frac{1 \text{ mol NO}_2}{6.022 \times 10^{23} \text{ molecules NO}_2}\right) = 7.63866 \times 10^{-3} \text{ mol NO}_2$$

$$\text{Mass (kg) of NO}_2 = \left(7.63866 \times 10^{-3} \text{ mol NO}_2\right) \left(\frac{46.01 \text{ g NO}_2}{1 \text{ mol NO}_2}\right) \left(\frac{1 \text{ kg}}{10^3 \text{ g}}\right) = 3.51455 \times 10^{-4} = \mathbf{3.5 \times 10^{-4} \text{ kg NO}_2}$$

$$\begin{aligned} \text{b) } \mathcal{M} \text{ of C}_2\text{H}_4\text{Cl}_2 &= (2 \times \mathcal{M} \text{ of C}) + (4 \times \mathcal{M} \text{ of H}) + (2 \times \mathcal{M} \text{ of Cl}) \\ &= (2 \times 12.01 \text{ g/mol C}) + (4 \times 1.008 \text{ g/mol H}) + (2 \times 35.45 \text{ g/mol Cl}) = 98.95 \text{ g/mol of C}_2\text{H}_4\text{Cl}_2 \end{aligned}$$

$$\text{Moles of C}_2\text{H}_4\text{Cl}_2 = \left(0.0615 \text{ g C}_2\text{H}_4\text{Cl}_2\right) \left(\frac{1 \text{ mol C}_2\text{H}_4\text{Cl}_2}{98.95 \text{ g C}_2\text{H}_4\text{Cl}_2}\right) = 6.21526 \times 10^{-4} \text{ mol C}_2\text{H}_4\text{Cl}_2$$

$$\begin{aligned} \text{Moles of Cl atoms} &= \left(6.21526 \times 10^{-4} \text{ mol C}_2\text{H}_4\text{Cl}_2\right) \left(\frac{2 \text{ mol Cl atoms}}{1 \text{ mol C}_2\text{H}_4\text{Cl}_2}\right) = 1.2431 \times 10^{-3} \\ &= \mathbf{1.24 \times 10^{-3} \text{ mol Cl atoms}} \end{aligned}$$

$$\text{c) } \mathcal{M} \text{ of SrH}_2 = (1 \times \mathcal{M} \text{ of Sr}) + (2 \times \mathcal{M} \text{ of H}) = (1 \times 87.62 \text{ g/mol Sr}) + (2 \times 1.008 \text{ g/mol H}) = 89.64 \text{ g/mol of SrH}_2$$

$$\text{Moles of SrH}_2 = \left(5.82 \text{ g SrH}_2\right) \left(\frac{1 \text{ mol SrH}_2}{89.64 \text{ g SrH}_2}\right) = 0.0649264 \text{ mol SrH}_2$$

$$\text{Moles of H}^- \text{ ions} = \left(0.0649264 \text{ mol SrH}_2\right) \left(\frac{2 \text{ mol H}^-}{1 \text{ mol SrH}_2}\right) = 0.1298528 \text{ mol H}^- \text{ ions}$$

$$\text{Number of H}^- \text{ ions} = \left(0.1298528 \text{ mol H}^- \text{ ions}\right) \left(\frac{6.022 \times 10^{23} \text{ H}^- \text{ ions}}{1 \text{ mol H}^-}\right) = 7.81974 \times 10^{22} = \mathbf{7.82 \times 10^{22} \text{ H}^- \text{ ions}}$$

3.13 Plan: Determine the molar mass of each substance, then perform the appropriate molar conversions. To find the mass in part a), multiply the number of moles by the molar mass of the substance. In part b), first convert the mass of compound in kg to mass in g and divide by the molar mass of the compound to find moles of compound. In part c), convert mass of compound in mg to mass in g and divide by the molar mass of the compound to find



moles of compound. Since 1 mole of compound contains 2 moles of nitrogen atoms, multiply the moles of compound by 2 to obtain moles of nitrogen atoms; then multiply by Avogadro's number to obtain the number of nitrogen atoms.

Solution:

$$\begin{aligned} \text{a) } \mathcal{M} \text{ of MnSO}_4 &= (1 \times \mathcal{M} \text{ of Mn}) + (1 \times \mathcal{M} \text{ of S}) + (4 \times \mathcal{M} \text{ of O}) \\ &= (1 \times 54.94 \text{ g/mol Mn}) + (1 \times 32.07 \text{ g/mol S}) + (4 \times 16.00 \text{ g/mol O}) = 151.01 \text{ g/mol of MnSO}_4 \end{aligned}$$

$$\text{Mass (g) of MnSO}_4 = \left( 6.44 \times 10^{-2} \text{ mol MnSO}_4 \right) \left( \frac{151.01 \text{ g MnSO}_4}{1 \text{ mol MnSO}_4} \right) = 9.725044 = \mathbf{9.73 \text{ g MnSO}_4}$$

$$\begin{aligned} \text{b) } \mathcal{M} \text{ of Fe(ClO}_4)_3 &= (1 \times \mathcal{M} \text{ of Fe}) + (3 \times \mathcal{M} \text{ of Cl}) + (12 \times \mathcal{M} \text{ of O}) \\ &= (1 \times 55.85 \text{ g/mol Fe}) + (3 \times 35.45 \text{ g/mol S}) + (12 \times 16.00 \text{ g/mol O}) \\ &= 354.20 \text{ g/mol of Fe(ClO}_4)_3 \end{aligned}$$

$$\text{Mass (g) of Fe(ClO}_4)_3 = \left( 15.8 \text{ kg Fe(ClO}_4)_3 \right) \left( \frac{10^3 \text{ g}}{1 \text{ kg}} \right) = 1.58 \times 10^4 \text{ kg Fe(ClO}_4)_3$$

$$\text{Moles of Fe(ClO}_4)_3 = \left( 1.58 \times 10^4 \text{ g Fe(ClO}_4)_3 \right) \left( \frac{1 \text{ mol Fe(ClO}_4)_3}{354.20 \text{ g Fe(ClO}_4)_3} \right) = 44.6076 = \mathbf{44.6 \text{ mol Fe(ClO}_4)_3}$$

$$\begin{aligned} \text{c) } \mathcal{M} \text{ of NH}_4\text{NO}_2 &= (2 \times \mathcal{M} \text{ of N}) + (4 \times \mathcal{M} \text{ of H}) + (2 \times \mathcal{M} \text{ of O}) \\ &= (2 \times 14.01 \text{ g/mol N}) + (4 \times 1.008 \text{ g/mol H}) + (2 \times 16.00 \text{ g/mol O}) = 64.05 \text{ g/mol NH}_4\text{NO}_2 \end{aligned}$$

$$\text{Mass (g) of NH}_4\text{NO}_2 = \left( 92.6 \text{ mg NH}_4\text{NO}_2 \right) \left( \frac{10^{-3} \text{ g}}{1 \text{ mg}} \right) = 0.0926 \text{ g NH}_4\text{NO}_2$$

$$\text{Moles of NH}_4\text{NO}_2 = \left( 0.0926 \text{ g NH}_4\text{NO}_2 \right) \left( \frac{1 \text{ mol NH}_4\text{NO}_2}{64.05 \text{ g NH}_4\text{NO}_2} \right) = 1.44575 \times 10^{-3} \text{ mol NH}_4\text{NO}_2$$

$$\text{Moles of N atoms} = \left( 1.44575 \times 10^{-3} \text{ mol NH}_4\text{NO}_2 \right) \left( \frac{2 \text{ mol N atoms}}{1 \text{ mol NH}_4\text{NO}_2} \right) = 2.8915 \times 10^{-3} \text{ mol N atoms}$$

$$\begin{aligned} \text{Number of N atoms} &= \left( 2.8915 \times 10^{-3} \text{ mol N atoms} \right) \left( \frac{6.022 \times 10^{23} \text{ N atoms}}{1 \text{ mol N atoms}} \right) \\ &= 1.74126 \times 10^{21} = \mathbf{1.74 \times 10^{21} \text{ N atoms}} \end{aligned}$$

- 3.14 Plan: Determine the molar mass of each substance, then perform the appropriate molar conversions. In part a), divide the mass by the molar mass of the compound to find moles of compound. Since 1 mole of compound contains 3 moles of ions (1 mole of  $\text{Sr}^{2+}$  and 2 moles of  $\text{F}^-$ ), multiply the moles of compound by 3 to obtain moles of ions and then multiply by Avogadro's number to obtain the number of ions. In part b), multiply the number of moles by the molar mass of the substance to find the mass in g and then convert to kg. In part c), divide the number of formula units by Avogadro's number to find moles; multiply the number of moles by the molar mass to obtain the mass in g and then convert to mg.

Solution:

$$\begin{aligned} \text{a) } \mathcal{M} \text{ of SrF}_2 &= (1 \times \mathcal{M} \text{ of Sr}) + (2 \times \mathcal{M} \text{ of F}) \\ &= (1 \times 87.62 \text{ g/mol Sr}) + (2 \times 19.00 \text{ g/mol F}) = 125.62 \text{ g/mol of SrF}_2 \end{aligned}$$

$$\text{Moles of SrF}_2 = \left( 38.1 \text{ g SrF}_2 \right) \left( \frac{1 \text{ mol SrF}_2}{125.62 \text{ g SrF}_2} \right) = 0.303296 \text{ mol SrF}_2$$

$$\text{Moles of ions} = \left( 0.303296 \text{ mol SrF}_2 \right) \left( \frac{3 \text{ mol ions}}{1 \text{ mol SrF}_2} \right) = 0.909888 \text{ mol ions}$$

$$\text{Number of ions} = \left( 0.909888 \text{ mol ions} \right) \left( \frac{6.022 \times 10^{23} \text{ ions}}{1 \text{ mol ions}} \right) = 5.47935 \times 10^{23} = \mathbf{5.48 \times 10^{23} \text{ ions}}$$

$$\begin{aligned} \text{b) } \mathcal{M} \text{ of CuCl}_2 \cdot 2\text{H}_2\text{O} &= (1 \times \mathcal{M} \text{ of Cu}) + (2 \times \mathcal{M} \text{ of Cl}) + (4 \times \mathcal{M} \text{ of H}) + (2 \times \mathcal{M} \text{ of O}) \\ &= (1 \times 63.55 \text{ g/mol Cu}) + (2 \times 35.45 \text{ g/mol Cl}) + (4 \times 1.008 \text{ g/mol H}) + (2 \times 16.00 \text{ g/mol O}) \\ &= 170.48 \text{ g/mol of CuCl}_2 \cdot 2\text{H}_2\text{O} \end{aligned}$$

(Note that the waters of hydration are included in the molar mass.)

$$\text{Mass (g) of CuCl}_2 \cdot 2\text{H}_2\text{O} = (3.58 \text{ mol CuCl}_2 \cdot 2\text{H}_2\text{O}) \left( \frac{170.48 \text{ g CuCl}_2 \cdot 2\text{H}_2\text{O}}{1 \text{ mol CuCl}_2 \cdot 2\text{H}_2\text{O}} \right) = 610.32 \text{ g CuCl}_2 \cdot 2\text{H}_2\text{O}$$

$$\text{Mass (kg) of CuCl}_2 \cdot 2\text{H}_2\text{O} = (610.32 \text{ g CuCl}_2 \cdot 2\text{H}_2\text{O}) \left( \frac{1 \text{ kg}}{10^3 \text{ g}} \right) = 0.61032 = \mathbf{0.610 \text{ kg CuCl}_2 \cdot 2\text{H}_2\text{O}}$$

$$\begin{aligned} \text{c) } \mathcal{M} \text{ of Bi(NO}_3)_3 \cdot 5\text{H}_2\text{O} &= (1 \times \mathcal{M} \text{ of Bi}) + (3 \times \mathcal{M} \text{ of N}) + (10 \times \mathcal{M} \text{ of H}) + (14 \times \mathcal{M} \text{ of O}) \\ &= (1 \times 209.0 \text{ g/mol Bi}) + (3 \times 14.01 \text{ g/mol N}) + (10 \times 1.008 \text{ g/mol H}) \\ &\quad + (14 \times 16.00 \text{ g/mol O}) = 485.11 \text{ g/mol of} \end{aligned}$$

Bi(NO<sub>3</sub>)<sub>3</sub>•5H<sub>2</sub>O

(Note that the waters of hydration are included in the molar mass.)

$$\text{Moles of Bi(NO}_3)_3 \cdot 5\text{H}_2\text{O} = (2.88 \times 10^{22} \text{ FU}) \left( \frac{1 \text{ mol}}{6.022 \times 10^{23} \text{ FU}} \right) = 0.047825 \text{ mol Bi(NO}_3)_3 \cdot 5\text{H}_2\text{O}$$

$$\text{Mass (g) of Bi(NO}_3)_3 \cdot 5\text{H}_2\text{O} = (0.047825 \text{ mol Bi(NO}_3)_3 \cdot 5\text{H}_2\text{O}) \left( \frac{485.1 \text{ g Bi(NO}_3)_3 \cdot 5\text{H}_2\text{O}}{1 \text{ mol Bi(NO}_3)_3 \cdot 5\text{H}_2\text{O}} \right) = 23.1999 \text{ g}$$

$$\begin{aligned} \text{Mass (mg) of Bi(NO}_3)_3 \cdot 5\text{H}_2\text{O} &= (23.1999 \text{ g Bi(NO}_3)_3 \cdot 5\text{H}_2\text{O}) \left( \frac{1 \text{ mg}}{10^{-3} \text{ g}} \right) \\ &= 23199.9 = \mathbf{2.32 \times 10^4 \text{ mg Bi(NO}_3)_3 \cdot 5\text{H}_2\text{O}} \end{aligned}$$

3.15

Plan: The formula of each compound must be determined from its name. The molar mass for each formula comes from the formula and atomic masses from the periodic table. Determine the molar mass of each substance, then perform the appropriate molar conversions. In part a), multiply the moles by the molar mass of the compound to find the mass of the sample. In part b), divide the number of molecules by Avogadro's number to find moles; multiply the number of moles by the molar mass to obtain the mass. In part c), divide the mass by the molar mass to find moles of compound and multiply moles by Avogadro's number to find the number of formula units. In part d), use the fact that each formula unit contains 1 Na ion, 1 perchlorate ion, 1 Cl atom, and 4 O atoms.

Solution:

a) Carbonate is a polyatomic anion with the formula, CO<sub>3</sub><sup>2-</sup>. Copper(I) indicates Cu<sup>+</sup>. The correct formula for this ionic compound is Cu<sub>2</sub>CO<sub>3</sub>.

$$\begin{aligned} \mathcal{M} \text{ of Cu}_2\text{CO}_3 &= (2 \times \mathcal{M} \text{ of Cu}) + (1 \times \mathcal{M} \text{ of C}) + (3 \times \mathcal{M} \text{ of O}) \\ &= (2 \times 63.55 \text{ g/mol Cu}) + (1 \times 12.01 \text{ g/mol C}) + (3 \times 16.00 \text{ g/mol O}) = 187.11 \text{ g/mol of Cu}_2\text{CO}_3 \end{aligned}$$

$$\text{Mass (g) of Cu}_2\text{CO}_3 = (8.35 \text{ mol Cu}_2\text{CO}_3) \left( \frac{187.11 \text{ g Cu}_2\text{CO}_3}{1 \text{ mol Cu}_2\text{CO}_3} \right) = 1562.4 = \mathbf{1.56 \times 10^3 \text{ g Cu}_2\text{CO}_3}$$

b) Dinitrogen pentoxide has the formula N<sub>2</sub>O<sub>5</sub>. Di- indicates 2 N atoms and penta- indicates 5 O atoms.

$$\begin{aligned} \mathcal{M} \text{ of N}_2\text{O}_5 &= (2 \times \mathcal{M} \text{ of N}) + (5 \times \mathcal{M} \text{ of O}) \\ &= (2 \times 14.01 \text{ g/mol N}) + (5 \times 16.00 \text{ g/mol O}) = 108.02 \text{ g/mol of N}_2\text{O}_5 \end{aligned}$$

$$\text{Moles of N}_2\text{O}_5 = (4.04 \times 10^{20} \text{ N}_2\text{O}_5 \text{ molecules}) \left( \frac{1 \text{ mol N}_2\text{O}_5}{6.022 \times 10^{23} \text{ N}_2\text{O}_5 \text{ molecules}} \right) = 6.7087 \times 10^{-4} \text{ mol N}_2\text{O}_5$$

$$\text{Mass (g) of N}_2\text{O}_5 = (6.7087 \times 10^{-4} \text{ mol N}_2\text{O}_5) \left( \frac{108.02 \text{ g N}_2\text{O}_5}{1 \text{ mol N}_2\text{O}_5} \right) = 0.072467 = \mathbf{0.0725 \text{ g N}_2\text{O}_5}$$

c) The correct formula for this ionic compound is NaClO<sub>4</sub>; Na has a charge of +1 (Group 1 ion) and the perchlorate ion is ClO<sub>4</sub><sup>-</sup>.

$$\begin{aligned} \mathcal{M} \text{ of NaClO}_4 &= (1 \times \mathcal{M} \text{ of Na}) + (1 \times \mathcal{M} \text{ of Cl}) + (4 \times \mathcal{M} \text{ of O}) \\ &= (1 \times 22.99 \text{ g/mol Na}) + (1 \times 35.45 \text{ g/mol Cl}) + (4 \times 16.00 \text{ g/mol O}) = 122.44 \text{ g/mol of NaClO}_4 \end{aligned}$$

$$\text{Moles of NaClO}_4 = (78.9 \text{ g NaClO}_4) \left( \frac{1 \text{ mol NaClO}_4}{122.44 \text{ g NaClO}_4} \right) = 0.644397 = \mathbf{0.644 \text{ mol NaClO}_4}$$

FU = formula units

$$\begin{aligned}\text{FU of NaClO}_4 &= (0.644397 \text{ mol NaClO}_4) \left( \frac{6.022 \times 10^{23} \text{ FU NaClO}_4}{1 \text{ mol NaClO}_4} \right) \\ &= 3.88056 \times 10^{23} = \mathbf{3.88 \times 10^{23} \text{ FU NaClO}_4}\end{aligned}$$

$$\text{d) Number of Na}^+ \text{ ions} = (3.88056 \times 10^{23} \text{ FU NaClO}_4) \left( \frac{1 \text{ Na}^+ \text{ ion}}{1 \text{ FU NaClO}_4} \right) = \mathbf{3.88 \times 10^{23} \text{ Na}^+ \text{ ions}}$$

$$\text{Number of ClO}_4^- \text{ ions} = (3.88056 \times 10^{23} \text{ FU NaClO}_4) \left( \frac{1 \text{ ClO}_4^- \text{ ion}}{1 \text{ FU NaClO}_4} \right) = \mathbf{3.88 \times 10^{23} \text{ ClO}_4^- \text{ ions}}$$

$$\text{Number of Cl atoms} = (3.88056 \times 10^{23} \text{ FU NaClO}_4) \left( \frac{1 \text{ Cl atom}}{1 \text{ FU NaClO}_4} \right) = \mathbf{3.88 \times 10^{23} \text{ Cl atoms}}$$

$$\text{Number of O atoms} = (3.88056 \times 10^{23} \text{ FU NaClO}_4) \left( \frac{4 \text{ O atoms}}{1 \text{ FU NaClO}_4} \right) = \mathbf{1.55 \times 10^{24} \text{ O atoms}}$$

- 3.16 Plan: The formula of each compound must be determined from its name. The molar mass for each formula comes from the formula and atomic masses from the periodic table. Determine the molar mass of each substance, then perform the appropriate molar conversions. In part a), multiply the moles by the molar mass of the compound to find the mass of the sample. In part b), divide the number of molecules by Avogadro's number to find moles; multiply the number of moles by the molar mass to obtain the mass. In part c), divide the mass by the molar mass to find moles of compound and multiply moles by Avogadro's number to find the number of formula units. In part d), use the fact that each formula unit contains 2 Li ions, 1 sulfate ion, 1 S atom, and 4 O atoms.

Solution:

a) Sulfate is a polyatomic anion with the formula,  $\text{SO}_4^{2-}$ . Chromium(III) indicates  $\text{Cr}^{3+}$ . Decahydrate indicates 10 water molecules ("waters of hydration"). The correct formula for this ionic compound is  $\text{Cr}_2(\text{SO}_4)_3 \cdot 10\text{H}_2\text{O}$ .

$$\begin{aligned}\mathcal{M} \text{ of } \text{Cr}_2(\text{SO}_4)_3 \cdot 10\text{H}_2\text{O} &= (2 \times \mathcal{M} \text{ of Cr}) + (3 \times \mathcal{M} \text{ of S}) + (22 \times \mathcal{M} \text{ of O}) + (20 \times \mathcal{M} \text{ of H}) \\ &= (2 \times 52.00 \text{ g/mol Cr}) + (3 \times 32.07 \text{ g/mol S}) + (22 \times 16.00 \text{ g/mol O}) + (20 \times 1.008 \text{ g/mol H}) \\ &= 572.4 \text{ g/mol of } \text{Cr}_2(\text{SO}_4)_3 \cdot 10\text{H}_2\text{O}\end{aligned}$$

$$\begin{aligned}\text{Mass (g) of } \text{Cr}_2(\text{SO}_4)_3 \cdot 10\text{H}_2\text{O} &= (8.42 \text{ mol } \text{Cr}_2(\text{SO}_4)_3 \cdot 10\text{H}_2\text{O}) \left( \frac{572.4 \text{ g}}{\text{mol}} \right) \\ &= 4819.608 = \mathbf{4.82 \times 10^3 \text{ g } \text{Cr}_2(\text{SO}_4)_3 \cdot 10\text{H}_2\text{O}}\end{aligned}$$

b) Dichlorine heptaoxide has the formula  $\text{Cl}_2\text{O}_7$ . Di- indicates 2 Cl atoms and hepta- indicates 7 O atoms.

$$\begin{aligned}\mathcal{M} \text{ of } \text{Cl}_2\text{O}_7 &= (2 \times \mathcal{M} \text{ of Cl}) + (7 \times \mathcal{M} \text{ of O}) \\ &= (2 \times 35.45 \text{ g/mol Cl}) + (7 \times 16.00 \text{ g/mol O}) = 182.9 \text{ g/mol of } \text{Cl}_2\text{O}_7\end{aligned}$$

$$\text{Moles of } \text{Cl}_2\text{O}_7 = (1.83 \times 10^{24} \text{ molecules } \text{Cl}_2\text{O}_7) \left( \frac{1 \text{ mol}}{6.022 \times 10^{23} \text{ molecules}} \right) = 3.038858 \text{ mol } \text{Cl}_2\text{O}_7$$

$$\text{Mass (g) of } \text{Cl}_2\text{O}_7 = (3.038858 \text{ mol } \text{Cl}_2\text{O}_7) \left( \frac{182.9 \text{ g } \text{Cl}_2\text{O}_7}{1 \text{ mol}} \right) = 555.807 = \mathbf{5.56 \times 10^2 \text{ g } \text{Cl}_2\text{O}_7}$$

c) The correct formula for this ionic compound is  $\text{Li}_2\text{SO}_4$ ; Li has a charge of +1 (Group 1 ion) and the sulfate ion is  $\text{SO}_4^{2-}$ .

$$\begin{aligned}\mathcal{M} \text{ of } \text{Li}_2\text{SO}_4 &= (2 \times \mathcal{M} \text{ of Li}) + (1 \times \mathcal{M} \text{ of S}) + (4 \times \mathcal{M} \text{ of O}) \\ &= (2 \times 6.941 \text{ g/mol Li}) + (1 \times 32.07 \text{ g/mol S}) + (4 \times 16.00 \text{ g/mol O}) = 109.95 \text{ g/mol of } \text{Li}_2\text{SO}_4\end{aligned}$$

$$\text{Moles of } \text{Li}_2\text{SO}_4 = (6.2 \text{ g } \text{Li}_2\text{SO}_4) \left( \frac{1 \text{ mol } \text{Li}_2\text{SO}_4}{109.95 \text{ g } \text{Li}_2\text{SO}_4} \right) = 0.056389 = \mathbf{0.056 \text{ mol } \text{Li}_2\text{SO}_4}$$

$$\text{FU of } \text{Li}_2\text{SO}_4 = (0.056389 \text{ mol } \text{Li}_2\text{SO}_4) \left( \frac{6.022 \times 10^{23} \text{ FU}}{1 \text{ mol } \text{Li}_2\text{SO}_4} \right) = 3.3957 \times 10^{22} = \mathbf{3.4 \times 10^{22} \text{ FU } \text{Li}_2\text{SO}_4}$$

$$\text{d) Number of Li}^+ \text{ ions} = \left( 3.3957 \times 10^{22} \text{ FU Li}_2\text{SO}_4 \right) \left( \frac{2 \text{ Li}^+ \text{ ions}}{1 \text{ FU Li}_2\text{SO}_4} \right) = 6.7914 \times 10^{22} = \mathbf{6.8 \times 10^{22} \text{ Li}^+ \text{ ions}}$$

$$\text{Number of SO}_4^{2-} \text{ ions} = \left( 3.3957 \times 10^{22} \text{ FU Li}_2\text{SO}_4 \right) \left( \frac{1 \text{ SO}_4^{2-} \text{ ion}}{1 \text{ FU Li}_2\text{SO}_4} \right) = 3.3957 \times 10^{22} = \mathbf{3.4 \times 10^{22} \text{ SO}_4^{2-} \text{ ions}}$$

$$\text{Number of S atoms} = \left( 3.3957 \times 10^{22} \text{ FU Li}_2\text{SO}_4 \right) \left( \frac{1 \text{ S atom}}{1 \text{ FU Li}_2\text{SO}_4} \right) = 3.3957 \times 10^{22} = \mathbf{3.4 \times 10^{22} \text{ S atoms}}$$

$$\text{Number of O atoms} = \left( 3.3957 \times 10^{22} \text{ FU Li}_2\text{SO}_4 \right) \left( \frac{4 \text{ O atoms}}{1 \text{ FU Li}_2\text{SO}_4} \right) = 1.3583 \times 10^{23} = \mathbf{1.4 \times 10^{23} \text{ O atoms}}$$

3.17 Plan: Determine the formula and the molar mass of each compound. The formula gives the relative number of moles of each element present. Multiply the number of moles of each element by its molar mass to find the total mass of element in 1 mole of compound. Mass percent =  $\frac{\text{total mass of element}}{\text{molar mass of compound}}(100)$ .

Solution:

a) Ammonium bicarbonate is an ionic compound consisting of ammonium ions,  $\text{NH}_4^+$  and bicarbonate ions,  $\text{HCO}_3^-$ . The formula of the compound is  $\text{NH}_4\text{HCO}_3$ .

$$\begin{aligned} \mathcal{M} \text{ of } \text{NH}_4\text{HCO}_3 &= (1 \times \mathcal{M} \text{ of N}) + (5 \times \mathcal{M} \text{ of H}) + (1 \times \mathcal{M} \text{ of C}) + (3 \times \mathcal{M} \text{ of O}) \\ &= (1 \times 14.01 \text{ g/mol N}) + (5 \times 1.008 \text{ g/mol H}) + (1 \times 12.01 \text{ g/mol C}) + (3 \times 16.00 \text{ g/mol O}) \\ &= 79.06 \text{ g/mol of } \text{NH}_4\text{HCO}_3 \end{aligned}$$

There are 5 moles of H in 1 mole of  $\text{NH}_4\text{HCO}_3$ .

$$\text{Mass (g) of H} = (5 \text{ mol H}) \left( \frac{1.008 \text{ g H}}{1 \text{ mol H}} \right) = 5.040 \text{ g H}$$

$$\text{Mass percent} = \frac{\text{total mass H}}{\text{molar mass of compound}}(100) = \frac{5.040 \text{ g H}}{79.06 \text{ g NH}_4\text{HCO}_3}(100) = 6.374905 = \mathbf{6.375\% \text{ H}}$$

b) Sodium dihydrogen phosphate heptahydrate is a salt that consists of sodium ions,  $\text{Na}^+$ , dihydrogen phosphate ions,  $\text{H}_2\text{PO}_4^-$ , and seven waters of hydration. The formula is  $\text{NaH}_2\text{PO}_4 \cdot 7\text{H}_2\text{O}$ . Note that the waters of hydration are included in the molar mass.

$$\begin{aligned} \mathcal{M} \text{ of } \text{NaH}_2\text{PO}_4 \cdot 7\text{H}_2\text{O} &= (1 \times \mathcal{M} \text{ of Na}) + (16 \times \mathcal{M} \text{ of H}) + (1 \times \mathcal{M} \text{ of P}) + (11 \times \mathcal{M} \text{ of O}) \\ &= (1 \times 22.99 \text{ g/mol Na}) + (16 \times 1.008 \text{ g/mol H}) + (1 \times 30.97 \text{ g/mol P}) + (11 \times 16.00 \text{ g/mol O}) \\ &= 246.09 \text{ g/mol NaH}_2\text{PO}_4 \cdot 7\text{H}_2\text{O} \end{aligned}$$

There are 11 moles of O in 1 mole of  $\text{NaH}_2\text{PO}_4 \cdot 7\text{H}_2\text{O}$ .

$$\text{Mass (g) of O} = (11 \text{ mol O}) \left( \frac{16.00 \text{ g O}}{1 \text{ mol O}} \right) = 176.00 \text{ g O}$$

$$\begin{aligned} \text{Mass percent} &= \frac{\text{total mass O}}{\text{molar mass of compound}}(100) = \frac{176.00 \text{ g O}}{246.09 \text{ g NaH}_2\text{PO}_4 \cdot 7\text{H}_2\text{O}}(100) \\ &= 71.51855 = \mathbf{71.52\% \text{ O}} \end{aligned}$$

3.18 Plan: Determine the formula and the molar mass of each compound. The formula gives the relative number of moles of each element present. Multiply the number of moles of each element by its molar mass to find the total mass of element in 1 mole of compound. Mass percent =  $\frac{\text{total mass of element}}{\text{molar mass of compound}}(100)$ .

Solution:

a) Strontium periodate is an ionic compound consisting of strontium ions,  $\text{Sr}^{2+}$  and periodate ions,  $\text{IO}_4^-$ . The formula of the compound is  $\text{Sr}(\text{IO}_4)_2$ .

$$\begin{aligned} \mathcal{M} \text{ of } \text{Sr}(\text{IO}_4)_2 &= (1 \times \mathcal{M} \text{ of Sr}) + (2 \times \mathcal{M} \text{ of I}) + (8 \times \mathcal{M} \text{ of O}) \\ &= (1 \times 87.62 \text{ g/mol Sr}) + (2 \times 126.9 \text{ g/mol I}) + (8 \times 16.00 \text{ g/mol O}) \\ &= 469.4 \text{ g/mol of } \text{Sr}(\text{IO}_4)_2 \end{aligned}$$

There are 2 moles of I in 1 mole of  $\text{Sr}(\text{IO}_4)_2$ .

$$\text{Mass (g) of I} = (2 \text{ mol I}) \left( \frac{126.9 \text{ g I}}{1 \text{ mol I}} \right) = 253.8 \text{ g I}$$

$$\text{Mass percent} = \frac{\text{total mass I}}{\text{molar mass of compound}} (100) = \frac{253.8 \text{ g I}}{469.4 \text{ g Sr(IO}_4)_2} (100) = 54.0690 = \mathbf{54.07\% \text{ I}}$$

b) Potassium permanganate is an ionic compound consisting of potassium ions,  $\text{K}^+$  and permanganate ions,  $\text{MnO}_4^-$ . The formula of the compound is  $\text{KMnO}_4$ .

$$\begin{aligned} \mathcal{M} \text{ of } \text{KMnO}_4 &= (1 \times \mathcal{M} \text{ of K}) + (1 \times \mathcal{M} \text{ of Mn}) + (4 \times \mathcal{M} \text{ of O}) \\ &= (1 \times 39.10 \text{ g/mol K}) + (1 \times 54.94 \text{ g/mol Mn}) + (4 \times 16.00 \text{ g/mol O}) \\ &= 158.04 \text{ g/mol of } \text{KMnO}_4 \end{aligned}$$

There is 1 mole of Mn in 1 mole of  $\text{KMnO}_4$ .

$$\text{Mass (g) of Mn} = (1 \text{ mol Mn}) \left( \frac{54.94 \text{ g Mn}}{1 \text{ mol Mn}} \right) = 54.94 \text{ g Mn}$$

$$\text{Mass percent} = \frac{\text{total mass Mn}}{\text{molar mass of compound}} (100) = \frac{54.94 \text{ g Mn}}{158.04 \text{ g KMnO}_4} (100) = 34.76335 = \mathbf{34.76\% \text{ Mn}}$$

- 3.19 **Plan:** Determine the formula of cisplatin from the figure, and then calculate the molar mass from the formula. Divide the mass given by the molar mass to find moles of cisplatin. Since 1 mole of cisplatin contains 6 moles of hydrogen atoms, multiply the moles given by 6 to obtain moles of hydrogen and then multiply by Avogadro's number to obtain the number of atoms.

**Solution:**

The formula for cisplatin is  $\text{Pt}(\text{Cl})_2(\text{NH}_3)_2$ .

$$\begin{aligned} \mathcal{M} \text{ of } \text{Pt}(\text{Cl})_2(\text{NH}_3)_2 &= (1 \times \mathcal{M} \text{ of Pt}) + (2 \times \mathcal{M} \text{ of Cl}) + (2 \times \mathcal{M} \text{ of N}) + (6 \times \mathcal{M} \text{ of H}) \\ &= (1 \times 195.1 \text{ g/mol Pt}) + (2 \times 35.45 \text{ g/mol Cl}) + (2 \times 14.01 \text{ g/mol N}) + (6 \times 1.008 \text{ g/mol H}) \\ &= 300.1 \text{ g/mol of } \text{Pt}(\text{Cl})_2(\text{NH}_3)_2 \end{aligned}$$

$$\text{a) Moles of cisplatin} = (285.3 \text{ g cisplatin}) \left( \frac{1 \text{ mol cisplatin}}{300.1 \text{ g cisplatin}} \right) = 0.9506831 = \mathbf{0.9507 \text{ mol cisplatin}}$$

$$\text{b) Moles of H atoms} = (0.98 \text{ mol cisplatin}) \left( \frac{6 \text{ mol H}}{1 \text{ mol cisplatin}} \right) = 5.88 \text{ mol H atoms}$$

$$\text{Number of H atoms} = (5.88 \text{ mol H atoms}) \left( \frac{6.022 \times 10^{23} \text{ H atoms}}{1 \text{ mol H atoms}} \right) = 3.540936 \times 10^{24} = \mathbf{3.5 \times 10^{24} \text{ H atoms}}$$

- 3.20 **Plan:** Determine the molar mass of propane. Divide the given mass by the molar mass to find the moles. Since each mole of propane contains 3 moles of carbon, multiply the moles of propane by 3 to obtain moles of C atoms. Multiply the moles of C by its molar mass to obtain mass of carbon.

**Solution:**

a) The formula of propane is  $\text{C}_3\text{H}_8$ .

$$\mathcal{M} \text{ of } \text{C}_3\text{H}_8 = (3 \times \mathcal{M} \text{ of C}) + (8 \times \mathcal{M} \text{ of H}) = (3 \times 12.01 \text{ g/mol C}) + (8 \times 1.008 \text{ g/mol H}) = 44.09 \text{ g/mol}$$

$$\text{Moles of } \text{C}_3\text{H}_8 = (85.5 \text{ g } \text{C}_3\text{H}_8) \left( \frac{1 \text{ mol } \text{C}_3\text{H}_8}{44.09 \text{ g } \text{C}_3\text{H}_8} \right) = 1.939215 = \mathbf{1.94 \text{ mol } \text{C}_3\text{H}_8}$$

$$\text{b) Moles of C} = (1.939215 \text{ mol } \text{C}_3\text{H}_8) \left( \frac{3 \text{ mol C}}{1 \text{ mol } \text{C}_3\text{H}_8} \right) = 5.817645 \text{ mol C}$$

$$\text{Mass (g) of C} = (5.817645 \text{ mol C}) \left( \frac{12.01 \text{ g C}}{1 \text{ mol C}} \right) = 69.86992 = \mathbf{69.9 \text{ g C}}$$

- 3.21 **Plan:** Determine the formula and the molar mass of each compound. The formula gives the relative number of moles of nitrogen present. Multiply the number of moles of nitrogen by its molar mass to find the total mass of nitrogen in 1 mole of compound. Divide the total mass of nitrogen by the molar mass of compound and multiply by 100 to determine mass percent.  $\text{Mass percent} = \frac{(\text{mol N}) \times (\text{molar mass N})}{\text{molar mass of compound}} (100)$ . Then rank the values in order of decreasing mass percent N.

**Solution:**

Name	Formula	Molar Mass (g/mol)
Potassium nitrate	$\text{KNO}_3$	101.11
Ammonium nitrate	$\text{NH}_4\text{NO}_3$	80.05
Ammonium sulfate	$(\text{NH}_4)_2\text{SO}_4$	132.15
Urea	$\text{CO}(\text{NH}_2)_2$	60.06

$$\text{Mass \% N in potassium nitrate} = \frac{(1 \text{ mol N})(14.01 \text{ g/mol N})}{101.11 \text{ g/mol}} \times 100 = 13.856196 = \mathbf{13.86\% \text{ N}}$$

$$\text{Mass \% N in ammonium nitrate} = \frac{(2 \text{ mol N})(14.01 \text{ g/mol N})}{80.05 \text{ g/mol}} \times 100 = 35.003123 = \mathbf{35.00\% \text{ N}}$$

$$\text{Mass \% N in ammonium sulfate} = \frac{(2 \text{ mol N})(14.01 \text{ g/mol N})}{132.15 \text{ g/mol}} \times 100 = 21.20318 = \mathbf{21.20\% \text{ N}}$$

$$\text{Mass \% N in urea} = \frac{(2 \text{ mol N})(14.01 \text{ g/mol N})}{60.06 \text{ g/mol}} \times 100 = 46.6533 = \mathbf{46.65\% \text{ N}}$$

Rank is  $\text{CO}(\text{NH}_2)_2 > \text{NH}_4\text{NO}_3 > (\text{NH}_4)_2\text{SO}_4 > \text{KNO}_3$

- 3.22 **Plan:** The volume must be converted from cubic feet to cubic centimeters. The volume and the density will give the mass of galena which is then divided by molar mass to obtain moles. Part b) requires a conversion from cubic decimeters to cubic centimeters. The density allows a change from volume in cubic centimeters to mass which is then divided by the molar mass to obtain moles; the amount in moles is multiplied by Avogadro's number to obtain formula units of PbS which is also the number of Pb atoms due to the 1:1 PbS:Pb mole ratio.

**Solution:**

Lead(II) sulfide is composed of  $\text{Pb}^{2+}$  and  $\text{S}^{2-}$  ions and has a formula of PbS.

$$\mathcal{M} \text{ of PbS} = (1 \times \mathcal{M} \text{ of Pb}) + (1 \times \mathcal{M} \text{ of S}) = (1 \times 207.2 \text{ g/mol Pb}) + (1 \times 32.07 \text{ g/mol S}) = 239.3 \text{ g/mol}$$

$$\text{a) Volume (cm}^3\text{)} = (1.00 \text{ ft}^3 \text{ PbS}) \left( \frac{(12 \text{ in})^3}{(1 \text{ ft})^3} \right) \left( \frac{(2.54 \text{ cm})^3}{(1 \text{ in})^3} \right) = 28316.85 \text{ cm}^3$$

$$\text{Mass (g) of PbS} = (28316.85 \text{ cm}^3 \text{ PbS}) \left( \frac{7.46 \text{ g PbS}}{1 \text{ cm}^3} \right) = 211243.7 \text{ g PbS}$$

$$\text{Moles of PbS} = (211243.7 \text{ g PbS}) \left( \frac{1 \text{ mol PbS}}{239.3 \text{ g PbS}} \right) = 882.7568 = \mathbf{883 \text{ mol PbS}}$$

$$\text{b) Volume (cm}^3\text{)} = (1.00 \text{ dm}^3 \text{ PbS}) \left( \frac{(0.1 \text{ m})^3}{(1 \text{ dm})^3} \right) \left( \frac{(1 \text{ cm})^3}{(10^{-2} \text{ m})^3} \right) = 1.00 \times 10^3 \text{ cm}^3$$

$$\text{Mass (g) of PbS} = (1.00 \times 10^3 \text{ cm}^3 \text{ PbS}) \left( \frac{7.46 \text{ g PbS}}{1 \text{ cm}^3} \right) = 7460 \text{ g PbS}$$

$$\text{Moles of PbS} = (7460 \text{ g PbS}) \left( \frac{1 \text{ mol PbS}}{239.3 \text{ g PbS}} \right) = 31.17426 \text{ mol PbS}$$

$$\text{Moles of Pb} = (31.17426 \text{ mol PbS}) \left( \frac{1 \text{ mol Pb}}{1 \text{ mol PbS}} \right) = 31.17426 \text{ mol Pb}$$

Number of lead atoms =

$$(31.17426 \text{ mol Pb}) \left( \frac{6.022 \times 10^{23} \text{ Pb atoms}}{1 \text{ mol Pb}} \right) = 1.87731 \times 10^{25} = \mathbf{1.88 \times 10^{25} \text{ Pb atoms}}$$

- 3.23 **Plan:** If the molecular formula for hemoglobin (Hb) were known, the number of  $\text{Fe}^{2+}$  ions in a molecule of hemoglobin could be calculated. It is possible to calculate the mass of iron from the percentage of iron and the molar mass of the compound. Assuming you have 1 mole of hemoglobin, take 0.33% of its molar mass as the mass of Fe in that 1 mole. Divide the mass of Fe by its molar mass to find moles of Fe in 1 mole of hemoglobin which is also the number of ions in 1 molecule.

**Solution:**

$$\text{Mass of Fe} = \left( \frac{0.33\% \text{ Fe}}{100\% \text{ Hb}} \right) \left( \frac{6.8 \times 10^4 \text{ g}}{\text{mol}} \right) = 224.4 \text{ g Fe}$$

$$\text{Moles of Fe} = (224.4 \text{ g Fe}) \left( \frac{1 \text{ mol Fe}}{55.85 \text{ g Fe}} \right) = 4.0179 = 4.0 \text{ mol Fe}^{2+}/\text{mol Hb}$$

Thus, there are **4  $\text{Fe}^{2+}$ /molecule Hb**.

- 3.24 **Plan:** Remember that the molecular formula tells the *actual* number of moles of each element in one mole of compound.

**Solution:**

a) No, this information does not allow you to obtain the molecular formula. You can obtain the empirical formula from the number of moles of each type of atom in a compound, but not the molecular formula.

b) Yes, you can obtain the molecular formula from the mass percentages and the total number of atoms.

**Plan:**

- 1) Assume a 100.0 g sample and convert masses (from the mass % of each element) to moles using molar mass.
- 2) Identify the element with the lowest number of moles and use this number to divide into the number of moles for each element. You now have at least one elemental mole ratio (the one with the smallest number of moles) equal to 1.00 and the remaining mole ratios that are larger than one.
- 3) Examine the numbers to determine if they are whole numbers. If not, multiply each number by a whole-number factor to get whole numbers for each element. You will have to use some judgment to decide when to round. Write the empirical formula using these whole numbers.
- 4) Check the total number of atoms in the empirical formula. If it equals the total number of atoms given then the empirical formula is also the molecular formula. If not, then divide the total number of atoms given by the total number of atoms in the empirical formula. This should give a whole number. Multiply the number of atoms of each element in the empirical formula by this whole number to get the molecular formula. If you do not get a whole number when you divide, return to step 3 and revise how you multiplied and rounded to get whole numbers for each element.

**Roadmap:**

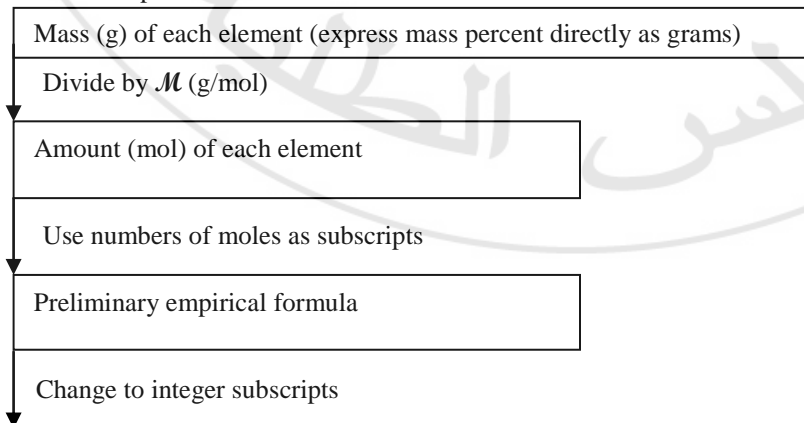

Empirical formula

Divide total number of atoms in molecule by the number of atoms in the empirical formula and multiply the empirical formula by that factor

Molecular formula

c) Yes, you can determine the molecular formula from the mass percent and the number of atoms of one element in a compound. Plan:

1) Follow steps 1–3 in part b).

2) Compare the number of atoms given for the one element to the number in the empirical formula. Determine the factor the number in the empirical formula must be multiplied by to obtain the given number of atoms for that element. Multiply the empirical formula by this number to get the molecular formula.

Roadmap:

(Same first three steps as in b).

Empirical formula

Divide the number of atoms of the one element in the molecule by the number of atoms of that element in the empirical formula and multiply the empirical formula by that factor

Molecular formula

d) No, the mass % will only lead to the empirical formula.

e) Yes, a structural formula shows all the atoms in the compound. Plan: Count the number of atoms of each type of element and record as the number for the molecular formula.

Roadmap:

Structural formula

Count the number of atoms of each element and use these numbers as subscripts

Molecular formula

3.25 Plan: Examine the number of atoms of each type in the compound. Divide all atom numbers by the common factor that results in the lowest whole-number values. Add the molar masses of the atoms to obtain the empirical formula mass.

Solution:

a)  $C_2H_4$  has a ratio of 2 carbon atoms to 4 hydrogen atoms, or 2:4. This ratio can be reduced to 1:2, so that the empirical formula is  **$CH_2$** . The empirical formula mass is  $12.01 \text{ g/mol C} + 2(1.008 \text{ g/mol H}) = \mathbf{14.03 \text{ g/mol}}$ .

b) The ratio of atoms is 2:6:2, or 1:3:1. The empirical formula is  **$CH_3O$**  and its empirical formula mass is  $12.01 \text{ g/mol C} + 3(1.008 \text{ g/mol H}) + 16.00 \text{ g/mol O} = \mathbf{31.03 \text{ g/mol}}$ .

c) Since, the ratio of elements cannot be further reduced, the molecular formula and empirical formula are the same,  **$N_2O_5$** . The formula mass is  $2(14.01 \text{ g/mol N}) + 5(16.00 \text{ g/mol O}) = \mathbf{108.02 \text{ g/mol}}$ .

d) The ratio of elements is 3 atoms of barium to 2 atoms of phosphorus to 8 atoms of oxygen, or 3:2:8. This ratio cannot be further reduced, so the empirical formula is also  **$Ba_3(PO_4)_2$** , with a formula mass of  $3(137.3 \text{ g/mol Ba}) + 2(30.97 \text{ g/mol P}) + 8(16.00 \text{ g/mol O}) = \mathbf{601.8 \text{ g/mol}}$ .

e) The ratio of atoms is 4:16, or 1:4. The empirical formula is  **$TeI_4$** , and the formula mass is  $127.6 \text{ g/mol Te} + 4(126.9 \text{ g/mol I}) = \mathbf{635.2 \text{ g/mol}}$ .



3.26 Plan: Examine the number of atoms of each type in the compound. Divide all atom numbers by the common factor that results in the lowest whole-number values. Add the molar masses of the atoms to obtain the empirical formula mass.

Solution:

- a)  $C_4H_8$  has a ratio of 4 carbon atoms to 8 hydrogen atoms, or 4:8. This ratio can be reduced to 1:2, so that the empirical formula is  $CH_2$ . The empirical formula mass is  $12.01 \text{ g/mol C} + 2(1.008 \text{ g/mol H}) = 14.03 \text{ g/mol}$ .
- b)  $C_3H_6O_3$  has a ratio of atoms of 3:6:3, or 1:2:1. The empirical formula is  $CH_2O$  and its empirical formula mass is  $12.01 \text{ g/mol C} + 2(1.008 \text{ g/mol H}) + 16.00 \text{ g/mol O} = 30.03 \text{ g/mol}$ .
- c)  $P_4O_{10}$  has a ratio of 4 P atoms to 10 O atoms, or 4:10. This ratio can be reduced to 2:5, so that the empirical formula is  $P_2O_5$ . The empirical formula mass is  $2(30.97 \text{ g/mol P}) + 5(16.00 \text{ g/mol O}) = 141.94 \text{ g/mol}$ .
- d)  $Ga_2(SO_4)_3$  has a ratio of 2 atoms of gallium to 3 atoms of sulfur to 12 atoms of oxygen, or 2:3:12. This ratio cannot be further reduced, so the empirical formula is also  $Ga_2(SO_4)_3$ , with a formula mass of  $2(69.72 \text{ g/mol Ga}) + 3(32.07 \text{ g/mol S}) + 12(16.00 \text{ g/mol O}) = 427.6 \text{ g/mol}$ .
- e)  $Al_2Br_6$  has a ratio of atoms of 2:6, or 1:3. The empirical formula is  $AlBr_3$ , and the formula mass is  $26.98 \text{ g/mol Al} + 3(79.90 \text{ g/mol Br}) = 266.7 \text{ g/mol}$ .

3.27 Plan: Determine the molar mass of each empirical formula. The subscripts in the molecular formula are whole-number multiples of the subscripts in the empirical formula. To find this whole number, divide the molar mass of the compound by its empirical formula mass. Multiply each subscript in the empirical formula by the whole number.

Solution:

Only approximate whole-number values are needed.

- a)  $CH_2$  has empirical mass equal to  $12.01 \text{ g/mol C} + 2(1.008 \text{ g/mol H}) = 14.03 \text{ g/mol}$

$$\text{Whole-number multiple} = \frac{\text{molar mass of compound}}{\text{empirical formula mass}} = \left( \frac{42.08 \text{ g/mol}}{14.03 \text{ g/mol}} \right) = 3$$

Multiplying the subscripts in  $CH_2$  by 3 gives  $C_3H_6$ .

- b)  $NH_2$  has empirical mass equal to  $14.01 \text{ g/mol N} + 2(1.008 \text{ g/mol H}) = 16.03 \text{ g/mol}$

$$\text{Whole-number multiple} = \frac{\text{molar mass of compound}}{\text{empirical formula mass}} = \left( \frac{32.05 \text{ g/mol}}{16.03 \text{ g/mol}} \right) = 2$$

Multiplying the subscripts in  $NH_2$  by 2 gives  $N_2H_4$ .

- c)  $NO_2$  has empirical mass equal to  $14.01 \text{ g/mol N} + 2(16.00 \text{ g/mol O}) = 46.01 \text{ g/mol}$

$$\text{Whole-number multiple} = \frac{\text{molar mass of compound}}{\text{empirical formula mass}} = \left( \frac{92.02 \text{ g/mol}}{46.01 \text{ g/mol}} \right) = 2$$

Multiplying the subscripts in  $NO_2$  by 2 gives  $N_2O_4$ .

- d)  $CHN$  has empirical mass equal to  $12.01 \text{ g/mol C} + 1.008 \text{ g/mol H} + 14.01 \text{ g/mol N} = 27.03 \text{ g/mol}$

$$\text{Whole-number multiple} = \frac{\text{molar mass of compound}}{\text{empirical formula mass}} = \left( \frac{135.14 \text{ g/mol}}{27.03 \text{ g/mol}} \right) = 5$$

Multiplying the subscripts in  $CHN$  by 5 gives  $C_5H_5N_5$ .

3.28 Plan: Determine the molar mass of each empirical formula. The subscripts in the molecular formula are whole-number multiples of the subscripts in the empirical formula. To find this whole number, divide the molar mass of the compound by its empirical formula mass. Multiply each subscript in the empirical formula by the whole number.

Solution:

Only approximate whole-number values are needed.

- a)  $CH$  has empirical mass equal to  $12.01 \text{ g/mol C} + 1.008 \text{ g/mol H} = 13.02 \text{ g/mol}$

$$\text{Whole-number multiple} = \frac{\text{molar mass of compound}}{\text{empirical formula mass}} = \left( \frac{78.11 \text{ g/mol}}{13.02 \text{ g/mol}} \right) = 6$$

Multiplying the subscripts in  $CH$  by 6 gives  $C_6H_6$ .

b)  $C_3H_6O_2$  has empirical mass equal to  $3(12.01 \text{ g/mol C}) + 6(1.008 \text{ g/mol H}) + 2(16.00 \text{ g/mol O}) = 74.08 \text{ g/mol}$

$$\text{Whole-number multiple} = \frac{\text{molar mass of compound}}{\text{empirical formula mass}} = \left( \frac{74.08 \text{ g/mol}}{74.08 \text{ g/mol}} \right) = 1$$

Multiplying the subscripts in  $C_3H_6O_2$  by 1 gives  $C_3H_6O_2$ .

c)  $HgCl$  has empirical mass equal to  $200.6 \text{ g/mol Hg} + 35.45 \text{ g/mol Cl} = 236.0 \text{ g/mol}$

$$\text{Whole-number multiple} = \frac{\text{molar mass of compound}}{\text{empirical formula mass}} = \left( \frac{472.1 \text{ g/mol}}{236.0 \text{ g/mol}} \right) = 2$$

Multiplying the subscripts in  $HgCl$  by 2 gives  $Hg_2Cl_2$ .

d)  $C_7H_4O_2$  has empirical mass equal to  $7(12.01 \text{ g/mol C}) + 4(1.008 \text{ g/mol H}) + 2(16.00 \text{ g/mol O}) = 120.10 \text{ g/mol}$

$$\text{Whole-number multiple} = \frac{\text{molar mass of compound}}{\text{empirical formula mass}} = \left( \frac{240.20 \text{ g/mol}}{120.10 \text{ g/mol}} \right) = 2$$

Multiplying the subscripts in  $C_7H_4O_2$  by 2 gives  $C_{14}H_8O_4$ .

3.29 **Plan:** The empirical formula is the smallest whole-number ratio of the atoms or moles in a formula. All data must be converted to moles of an element by dividing mass by the molar mass. Divide each mole number by the smallest mole number to convert the mole ratios to whole numbers.

**Solution:**

a) 0.063 mol Cl and 0.22 mol O: preliminary formula is  $Cl_{0.063}O_{0.22}$

Converting to integer subscripts (dividing all by the smallest subscript):

$$\frac{Cl_{0.063}O_{0.22}}{0.063 \quad 0.063} \rightarrow Cl_1O_{3.5}$$

The formula is  $Cl_1O_{3.5}$ , which in whole numbers (x 2) is  $Cl_2O_7$ .

b) Find moles of elements by dividing by molar mass:

$$\text{Moles of Si} = (2.45 \text{ g Si}) \left( \frac{1 \text{ mol Si}}{28.09 \text{ g Si}} \right) = 0.08722 \text{ mol Si}$$

$$\text{Moles of Cl} = (12.4 \text{ g Cl}) \left( \frac{1 \text{ mol Cl}}{35.45 \text{ g Cl}} \right) = 0.349788 \text{ mol Cl}$$

Preliminary formula is  $Si_{0.08722}Cl_{0.349788}$

Converting to integer subscripts (dividing all by the smallest subscript):

$$\frac{Si_{0.08722}Cl_{0.349788}}{0.08722 \quad 0.349788} \rightarrow Si_1Cl_4$$

The empirical formula is  $SiCl_4$ .

c) Assume a 100 g sample and convert the masses to moles by dividing by the molar mass:

$$\text{Moles of C} = (100 \text{ g}) \left( \frac{27.3 \text{ parts C by mass}}{100 \text{ parts by mass}} \right) \left( \frac{1 \text{ mol C}}{12.01 \text{ g C}} \right) = 2.2731 \text{ mol C}$$

$$\text{Moles of O} = (100 \text{ g}) \left( \frac{72.7 \text{ parts O by mass}}{100 \text{ parts by mass}} \right) \left( \frac{1 \text{ mol O}}{16.00 \text{ g O}} \right) = 4.5438 \text{ mol O}$$

Preliminary formula is  $C_{2.2731}O_{4.5438}$

Converting to integer subscripts (dividing all by the smallest subscript):

$$\frac{C_{2.2731}O_{4.5438}}{2.2731 \quad 2.2731} \rightarrow C_1O_2$$

The empirical formula is  $CO_2$ .

3.30 **Plan:** The empirical formula is the smallest whole-number ratio of the atoms or moles in a formula. All data must be converted to moles of an element by dividing mass by the molar mass. Divide each mole number by the smallest mole number to convert the mole ratios to whole numbers.

**Solution:**

a) 0.039 mol Fe and 0.052 mol O: preliminary formula is  $Fe_{0.039}O_{0.052}$

Converting to integer subscripts (dividing all by the smallest subscript):

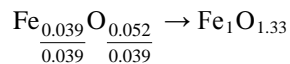

The formula is  $\text{Fe}_1\text{O}_{1.33}$ , which in whole numbers (x 3) is  **$\text{Fe}_3\text{O}_4$** .

b) Find moles of elements by dividing by molar mass:

$$\text{Moles of P} = (0.903 \text{ g P}) \left( \frac{1 \text{ mol P}}{30.97 \text{ g P}} \right) = 0.029157 \text{ mol P}$$

$$\text{Moles of Br} = (6.99 \text{ g Br}) \left( \frac{1 \text{ mol Br}}{79.90 \text{ g Br}} \right) = 0.087484 \text{ mol Br}$$

Preliminary formula is  $\text{P}_{0.029157}\text{Br}_{0.087484}$

Converting to integer subscripts (dividing all by the smallest subscript):

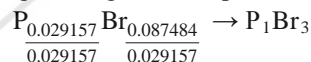

The empirical formula is  **$\text{PBr}_3$** .

c) Assume a 100 g sample and convert the masses to moles by dividing by the molar mass:

79.9% C and  $100 - 79.9 = 20.1\%$  H

$$\text{Moles of C} = (100 \text{ g}) \left( \frac{79.9 \text{ parts C by mass}}{100 \text{ parts by mass}} \right) \left( \frac{1 \text{ mol C}}{12.01 \text{ g C}} \right) = 6.6528 \text{ mol C}$$

$$\text{Moles of H} = (100 \text{ g}) \left( \frac{20.1 \text{ parts H by mass}}{100 \text{ parts by mass}} \right) \left( \frac{1 \text{ mol H}}{1.008 \text{ g H}} \right) = 19.940 \text{ mol H}$$

Preliminary formula is  $\text{C}_{6.6528}\text{H}_{19.940}$

Converting to integer subscripts (dividing all by the smallest subscript):

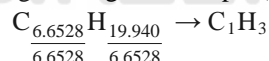

The empirical formula is  **$\text{CH}_3$** .

- 3.31 Plan: The moles of the metal are known, and the moles of fluorine atoms may be found in part a) from the M:F mole ratio in the compound formula. In part b), convert moles of F atoms to mass and subtract the mass of F from the mass of  $\text{MF}_2$  to find the mass of M. In part c), divide the mass of M by moles of M to determine the molar mass of M which can be used to identify the element.

Solution:

a) Determine the moles of fluorine.

$$\text{Moles of F} = (0.600 \text{ mol M}) \left( \frac{2 \text{ mol F}}{1 \text{ mol M}} \right) = \mathbf{1.20 \text{ mol F}}$$

b) Determine the mass of M.

$$\text{Mass of F} = (1.20 \text{ mol F}) \left( \frac{19.00 \text{ g F}}{1 \text{ mol F}} \right) = 22.8 \text{ g F}$$

$$\text{Mass (g) of M} = \text{MF}_2(\text{g}) - \text{F}(\text{g}) = 46.8 \text{ g} - 22.8 \text{ g} = \mathbf{24.0 \text{ g M}}$$

c) The molar mass is needed to identify the element.

$$\text{Molar mass of M} = \frac{24.0 \text{ g M}}{0.600 \text{ mol M}} = 40.0 \text{ g/mol}$$

The metal with the closest molar mass to 40.0 g/mol is **calcium**.

- 3.32 Plan: The moles of the metal oxide are known, and the moles of oxygen atoms may be found in part a) from the compound:oxygen mole ratio in the compound formula. In part b), convert moles of O atoms to mass and subtract the mass of O from the mass of  $\text{M}_2\text{O}_3$  to find the mass of M. In part c), find moles of M from the compound:M mole ratio and divide the mass of M by moles of M to determine the molar mass of M which can be used to identify the element.

Solution:

a) Determine the moles of oxygen.

$$\text{Moles of O} = (0.370 \text{ mol M}_2\text{O}_3) \left( \frac{3 \text{ mol O}}{1 \text{ mol M}_2\text{O}_3} \right) = \mathbf{1.11 \text{ mol O}}$$

b) Determine the mass of M.

$$\text{Mass of O} = (1.11 \text{ mol O}) \left( \frac{16.00 \text{ g O}}{1 \text{ mol O}} \right) = 17.76 \text{ g O}$$

$$\text{Mass(g) of M} = \text{M}_2\text{O}_3(\text{g}) - \text{O}(\text{g}) = 55.4 \text{ g (M + O)} - 17.76 = 37.64 = \mathbf{37.6 \text{ g M}}$$

c) First, the number of moles of M must be calculated.

$$\text{Moles M} = (0.370 \text{ mol M}_2\text{O}_3) \left( \frac{2 \text{ mol M}}{1 \text{ mol M}_2\text{O}_3} \right) = 0.740 \text{ mol M}$$

The molar mass is needed to identify the element.

$$\text{Molar mass of M} = \frac{37.6 \text{ g M}}{0.740 \text{ mol M}} = 50.86 \text{ g/mol}$$

The metal with the closest molar mass to 50.9 g/mol is **vanadium**.

- 3.33 Plan: The empirical formula is the smallest whole-number ratio of the atoms or moles in a formula. Assume 100 grams of cortisol so the percentages are numerically equivalent to the masses of each element. Convert each of the masses to moles by dividing by the molar mass of each element involved. Divide each mole number by the smallest mole number to convert the mole ratios to whole numbers. The subscripts in the molecular formula are whole-number multiples of the subscripts in the empirical formula. To find this whole number, divide the molar mass of the compound by its empirical formula mass. Multiply each subscript in the empirical formula by the whole number.

Solution:

$$\text{Moles of C} = (69.6 \text{ g C}) \left( \frac{1 \text{ mol C}}{12.01 \text{ g C}} \right) = 5.7952 \text{ mol C}$$

$$\text{Moles of H} = (8.34 \text{ g H}) \left( \frac{1 \text{ mol H}}{1.008 \text{ g H}} \right) = 8.2738 \text{ mol H}$$

$$\text{Moles of O} = (22.1 \text{ g O}) \left( \frac{1 \text{ mol O}}{16.00 \text{ g O}} \right) = 1.38125 \text{ mol O}$$

Preliminary formula is  $\text{C}_{5.7952}\text{H}_{8.2738}\text{O}_{1.38125}$

Converting to integer subscripts (dividing all by the smallest subscript):

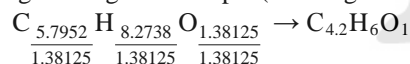

The carbon value is not close enough to a whole number to round the value. The smallest number that 4.20 may be multiplied by to get close to a whole number is 5. (You may wish to prove this to yourself.) All three ratios need to be multiplied by five:  $5(\text{C}_{4.2}\text{H}_6\text{O}_1) = \text{C}_{21}\text{H}_{30}\text{O}_5$ .

The empirical formula mass is  $= 21(12.01 \text{ g/mol C}) + 30(1.008 \text{ g/mol H}) + 5(16.00 \text{ g/mol O}) = 362.45 \text{ g/mol}$

$$\text{Whole-number multiple} = \frac{\text{molar mass of compound}}{\text{empirical formula mass}} = \left( \frac{362.47 \text{ g/mol}}{362.45 \text{ g/mol}} \right) = 1$$

The empirical formula mass and the molar mass given are the same, so the empirical and the molecular formulas are the same. The molecular formula is  $\text{C}_{21}\text{H}_{30}\text{O}_5$ .

- 3.34 Plan: In combustion analysis, finding the moles of carbon and hydrogen is relatively simple because all of the carbon present in the sample is found in the carbon of  $\text{CO}_2$ , and all of the hydrogen present in the sample is found in the hydrogen of  $\text{H}_2\text{O}$ . Convert the mass of  $\text{CO}_2$  to moles and use the ratio between  $\text{CO}_2$  and C to find the moles and mass of C present. Do the same to find the moles and mass of H from  $\text{H}_2\text{O}$ . The moles of oxygen are more difficult to find, because additional  $\text{O}_2$  was added to cause the combustion reaction. Subtracting the masses of C and H from the mass of the sample gives the mass of O. Convert the mass of O to moles of O. Take the moles of C, H, and O and divide by the smallest value to convert to whole numbers to get the empirical formula.

Determine the empirical formula mass and compare it to the molar mass given in the problem to see how the empirical and molecular formulas are related. Finally, determine the molecular formula.

Solution:

$$\text{Moles of C} = (0.449 \text{ g CO}_2) \left( \frac{1 \text{ mol CO}_2}{44.01 \text{ g CO}_2} \right) \left( \frac{1 \text{ mol C}}{1 \text{ mol CO}_2} \right) = 0.010202 \text{ mol C}$$

$$\text{Mass (g) of C} = (0.010202 \text{ mol C}) \left( \frac{12.01 \text{ g C}}{1 \text{ mol C}} \right) = 0.122526 \text{ g C}$$

$$\text{Moles of H} = (0.184 \text{ g H}_2\text{O}) \left( \frac{1 \text{ mol H}_2\text{O}}{18.02 \text{ g H}_2\text{O}} \right) \left( \frac{2 \text{ mol H}}{1 \text{ mol H}_2\text{O}} \right) = 0.020422 \text{ mol H}$$

$$\text{Mass (g) of H} = (0.020422 \text{ mol H}) \left( \frac{1.008 \text{ g H}}{1 \text{ mol H}} \right) = 0.020585 \text{ g H}$$

$$\begin{aligned} \text{Mass (g) of O} &= \text{Sample mass} - (\text{mass of C} + \text{mass of H}) \\ &= 0.1595 \text{ g} - (0.122526 \text{ g C} + 0.020585 \text{ g H}) = 0.016389 \text{ g O} \end{aligned}$$

$$\text{Moles of O} = (0.016389 \text{ g O}) \left( \frac{1 \text{ mol O}}{16.00 \text{ g O}} \right) = 0.0010243 \text{ mol O}$$

$$\text{Preliminary formula} = \text{C}_{0.010202}\text{H}_{0.020422}\text{O}_{0.0010243}$$

Converting to integer subscripts (dividing all by the smallest subscript):

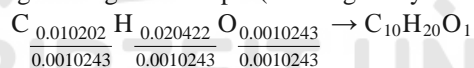

$$\text{Empirical formula} = \text{C}_{10}\text{H}_{20}\text{O}$$

$$\text{Empirical formula mass} = 10(12.01 \text{ g/mol C}) + 20(1.008 \text{ g/mol H}) + 1(16.00 \text{ g/mol O}) = 156.26 \text{ g/mol}$$

The empirical formula mass is the same as the given molar mass so the empirical and molecular formulas are the same. The molecular formula is **C<sub>10</sub>H<sub>20</sub>O**.

- 3.35 Students I and II are incorrect. Both students changed a given formula. Only coefficients should be changed when balancing; subscripts cannot be changed. Student I failed to identify the product correctly, writing AlCl<sub>2</sub> instead of AlCl<sub>3</sub>. Student II used atomic chlorine instead of molecular chlorine as a reactant. Student III followed the correct process, changing only coefficients.

- 3.36 Plan: Examine the diagram and label each formula. We will use A for red atoms and B for green atoms.

Solution:

The reaction shows A<sub>2</sub> and B<sub>2</sub> diatomic molecules forming AB molecules. Equal numbers of A<sub>2</sub> and B<sub>2</sub> combine to give twice as many molecules of AB. Thus, the reaction is A<sub>2</sub> + B<sub>2</sub> → 2 AB. This is the balanced equation in **b**.

- 3.37 Plan: Balancing is a trial-and-error procedure. Balance one element at a time, placing coefficients where needed to have the same number of atoms of a particular element on each side of the equation. The smallest whole-number coefficients should be used.

Solution:



Balance the S first, because there is an obvious deficiency of S on the right side of the equation. The 8 S atoms in S<sub>8</sub> require the coefficient 8 in front of Cu<sub>2</sub>S:



Then balance the Cu. The 16 Cu atoms in Cu<sub>2</sub>S require the coefficient 16 in front of Cu:

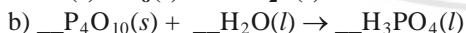
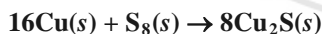

Balance the P first, because there is an obvious deficiency of P on the right side of the equation. The 4 P atoms in P<sub>4</sub>O<sub>10</sub> require a coefficient of 4 in front of H<sub>3</sub>PO<sub>4</sub>:



Balance the H next, because H is present in only one reactant and only one product. The 12 H atoms in 4H<sub>3</sub>PO<sub>4</sub> on the right require a coefficient of 6 in front of H<sub>2</sub>O:

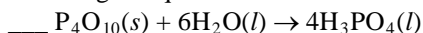

Balance the O last, because it appears in both reactants and is harder to balance. There are 16 O atoms on each side:

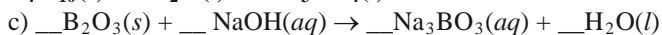

Balance oxygen last because it is present in more than one place on each side of the reaction. The 2 B atoms in  $B_2O_3$  on the left require a coefficient of 2 in front of  $Na_3BO_3$  on the right:

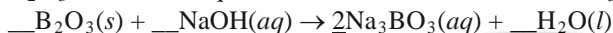

The 6 Na atoms in  $2Na_3BO_3$  on the right require a coefficient of 6 in front of NaOH on the left:

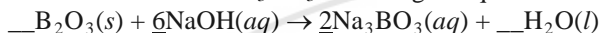

The 6 H atoms in  $6NaOH$  on the left require a coefficient of 3 in front of  $H_2O$  on the right:

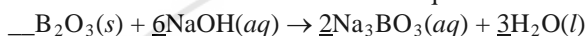

The oxygen is now balanced with 9 O atoms on each side:

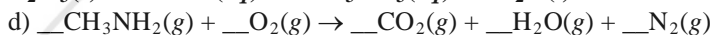
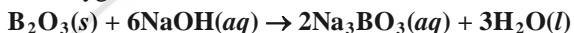

There are 2 N atoms on the right in  $N_2$  so a coefficient of 2 is required in front of  $CH_3NH_2$  on the left:

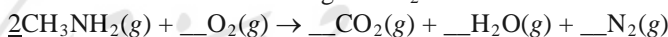

There are now 10 H atoms in  $2CH_3NH_2$  on the left so a coefficient of 5 is required in front of  $H_2O$  on the right:



The 2 C atoms on the left require a coefficient of 2 in front of  $CO_2$  on the right:

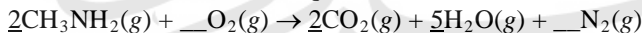

The 9 O atoms on the right (4 O atoms in  $2CO_2$  plus 5 in  $5H_2O$ ) require a coefficient of  $9/2$  in front of  $O_2$  on the left:



Multiply all coefficients by 2 to obtain whole numbers:



- 3.38 Plan: Balancing is a trial-and-error procedure. Balance one element at a time, placing coefficients where needed to have the same number of atoms of a particular element on each side of the equation. The smallest whole-number coefficients should be used.

Solution:

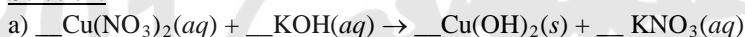

The 2 N atoms in  $Cu(NO_3)_2$  on the left require a coefficient of 2 in front of  $KNO_3$  on the right:

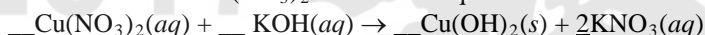

The 2 K atoms in  $2KNO_3$  on the right require a coefficient of 2 in front of KOH on the left:

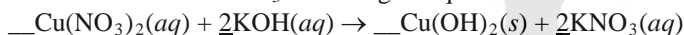

There are 8 O atoms and 2 H atoms on each side:

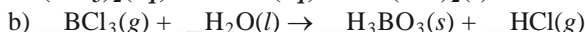
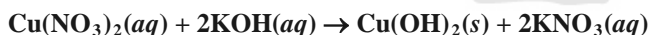

The 3 Cl atoms in  $BCl_3$  on the left require a coefficient of 3 in front of HCl on the right:

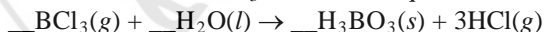

The 6 H atoms on the right (3 in  $H_3BO_3$  and 3 in HCl) require a coefficient of 3 in front of  $H_2O$  on the left:

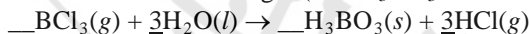

There are 3 O atoms and 1 B atom on each side:

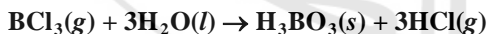

The 6 F atoms on the right (4 in  $SiF_4$  and 2 in  $CaF_2$ ) require a coefficient of 6 in front of HF on the left:



The 6 H atoms in  $6HF$  on the left require a coefficient of 3 in front of  $H_2O$  on the right:



There are 1 Ca atom, 1 Si atom, and 3 O atoms on each side:

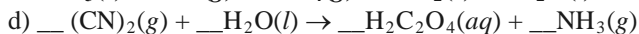

The 2 N atoms in  $(CN)_2$  on the left requires a coefficient of 2 in front of  $NH_3$  on the left:

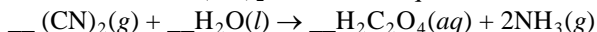

The 4 O atoms in  $\text{H}_2\text{C}_2\text{O}_4$  on the right requires a coefficient of 4 in front of  $\text{H}_2\text{O}$  on the right:

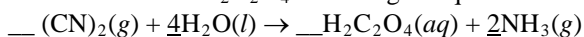

There are 2 C atoms and 8 H atoms on each side:



- 3.39 **Plan:** The names must first be converted to chemical formulas. Balancing is a trial-and-error procedure. Balance one element at a time, placing coefficients where needed to have the same number of atoms of a particular element on each side of the equation. The smallest whole-number coefficients should be used. Remember that oxygen is diatomic.

**Solution:**

a) Gallium (a solid) and oxygen (a gas) are reactants and solid gallium(III) oxide is the only product:

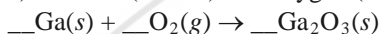

A coefficient of 2 in front of Ga on the left is needed to balance the 2 Ga atoms in  $\text{Ga}_2\text{O}_3$ :

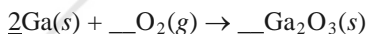

The 3 O atoms in  $\text{Ga}_2\text{O}_3$  on the right require a coefficient of 3/2 in front of  $\text{O}_2$  on the left:

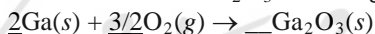

Multiply all coefficients by 2 to obtain whole numbers:

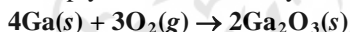

b) Liquid hexane and oxygen gas are the reactants while carbon dioxide gas and gaseous water are the products:



The 6 C atoms in  $\text{C}_6\text{H}_{14}$  on the left require a coefficient of 6 in front of  $\text{CO}_2$  on the right:

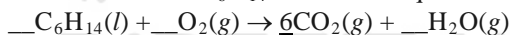

The 14 H atoms in  $\text{C}_6\text{H}_{14}$  on the left require a coefficient of 7 in front of  $\text{H}_2\text{O}$  on the right:

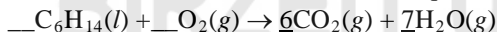

The 19 O atoms on the right (12 in  $6\text{CO}_2$  and 7 in  $7\text{H}_2\text{O}$ ) require a coefficient of 19/2 in front of  $\text{O}_2$  on the left:

Multiply all coefficients by 2 to obtain whole numbers:

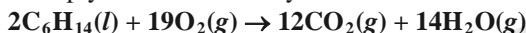

c) Aqueous solutions of calcium chloride and sodium phosphate are the reactants; solid calcium phosphate and an aqueous solution of sodium chloride are the products:

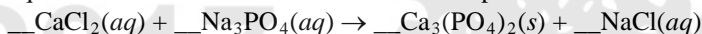

The 3 Ca atoms in  $\text{Ca}_3(\text{PO}_4)_2$  on the right require a coefficient of 3 in front of  $\text{CaCl}_2$  on the left:



The 6 Cl atoms in  $3\text{CaCl}_2$  on the left require a coefficient of 6 in front of  $\text{NaCl}$  on the right:

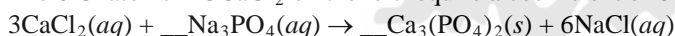

The 6 Na atoms in  $6\text{NaCl}$  on the right require a coefficient of 2 in front of  $\text{Na}_3\text{PO}_4$  on the left:

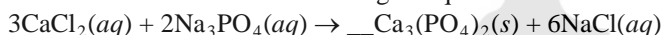

There are now 2 P atoms on each side:

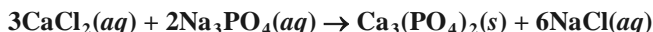

- 3.40 **Plan:** The names must first be converted to chemical formulas. Balancing is a trial-and-error procedure. Balance one element at a time, placing coefficients where needed to have the same number of atoms of a particular element on each side of the equation. The smallest whole-number coefficients should be used. Remember that oxygen is diatomic.

**Solution:**

a) Aqueous solutions of lead(II) nitrate and potassium iodide are the reactants; solid lead(II) iodide and an aqueous solution of potassium nitrate are the products:

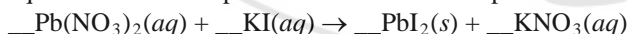

There are 2 N atoms in  $\text{Pb}(\text{NO}_3)_2$  on the left so a coefficient of 2 is required in front of  $\text{KNO}_3$  on the right:

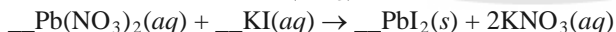

The 2 K atoms in  $2\text{KNO}_3$  and the 2 I atoms in  $\text{PbI}_2$  on the right require a coefficient of 2 in front of  $\text{KI}$  on the left:

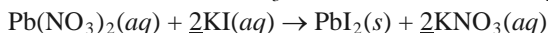

There are now 6 O atoms on each side:

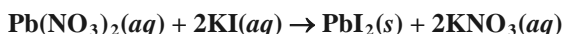

b) Liquid disilicon hexachloride and water are the reactants and solid silicon dioxide, hydrogen chloride gas and hydrogen gas are the products:



The 2 Si atoms in  $\text{Si}_2\text{Cl}_6$  on the left require a coefficient of 2 in front of  $\text{SiO}_2$  on the right:



The 6 Cl atoms in  $\text{Si}_2\text{Cl}_6$  on the left require a coefficient of 6 in front of HCl on the right:

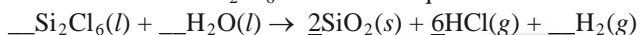

The 4 O atoms in  $2\text{SiO}_2$  on the right require a coefficient of 4 in front of  $\text{H}_2\text{O}$  on the left:

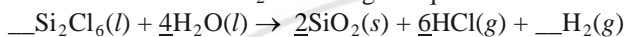

There are 8 H atoms in  $4\text{H}_2\text{O}$  on the left; there are 8 H atoms on the right (6 in  $6\text{HCl}$  and 2 in  $\text{H}_2$ ):

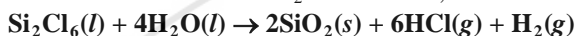

c) Nitrogen dioxide and water are the reactants and an aqueous solution of nitric acid and nitrogen monoxide gas are the products:

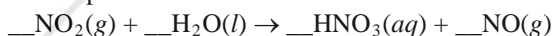

Start with hydrogen it occurs in only one reactant and one product:

The 2 H atoms in  $\text{H}_2\text{O}$  on the left require a coefficient of 2 in front of  $\text{HNO}_3$  on the right:

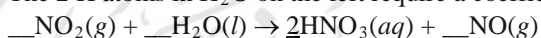

The 3 N atoms on the right (2 in  $2\text{HNO}_3$  and 1 in  $\text{NO}$ ) require a coefficient of 3 in front of  $\text{NO}_2$  on the left;

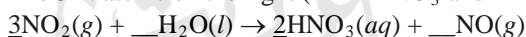

There are now 7 O atoms on each side:

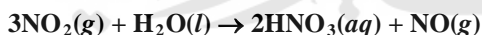

- 3.41 Plan: Write a balanced chemical reaction to obtain the mole ratio between the reactants. Compare the number of particles of each reactant with the mole ratio to find the limiting reactant. Use the limiting reactant to calculate the number of product molecules that will form.

Solution:

a) The reaction is  $\text{A}_2 + \text{B}_2 \rightarrow \text{AB}_3$  or  $\text{A}_2 + 3\text{B}_2 \rightarrow 2\text{AB}_3$ . The mole ratio between  $\text{A}_2$  and  $\text{B}_2$  is 1:3. Three times as many  $\text{B}_2$  molecules are required as you have of  $\text{A}_2$  molecules. With 3  $\text{A}_2$  molecules present,  $3 \times 3 = 9$   $\text{B}_2$  molecules would be required. Since you have only 6  $\text{B}_2$  molecules,  **$\text{B}_2$  is the limiting reagent.**

b) The balanced equation shows that  $2\text{AB}_3$  molecules are produced for every 3  $\text{B}_2$  molecules that react. Use the 3:2 mole ratio between the limiting reactant,  $\text{B}_2$ , and  $\text{AB}_3$ :

$$\text{Number of molecules of product} = (6 \text{ B}_2 \text{ molecules}) \left( \frac{2 \text{ AB}_3 \text{ molecules}}{3 \text{ B}_2 \text{ molecules}} \right) = \mathbf{4 \text{ AB}_3 \text{ molecules}}$$

- 3.42 Plan: Convert the kilograms of oxygen to grams of oxygen and then moles of oxygen by dividing by its molar mass. Use the moles of oxygen and the mole ratio from the balanced chemical equation to determine the moles of  $\text{KNO}_3$  required. Multiply the moles of  $\text{KNO}_3$  by its molar mass to obtain the mass in grams.

Solution:

$$\text{a) Mass (g) of O}_2 = (56.6 \text{ kg O}_2) \left( \frac{10^3 \text{ g}}{1 \text{ kg}} \right) = 5.66 \times 10^4 \text{ g O}_2$$

$$\text{Moles of O}_2 = (5.66 \times 10^4 \text{ g O}_2) \left( \frac{1 \text{ mol O}_2}{32.00 \text{ g O}_2} \right) = 1.76875 \times 10^3 \text{ mol O}_2$$

$$\text{Moles of KNO}_3 = (1.76875 \text{ mol O}_2) \left( \frac{4 \text{ mol KNO}_3}{5 \text{ mol O}_2} \right) = 1415 = \mathbf{1.42 \times 10^3 \text{ mol KNO}_3}$$

$$\text{b) Mass (g) of KNO}_3 = (1415 \text{ mol KNO}_3) \left( \frac{101.11 \text{ g KNO}_3}{1 \text{ mol KNO}_3} \right) = 143070.65 = \mathbf{1.43 \times 10^5 \text{ g KNO}_3}$$

Combining all steps gives:

$$\begin{aligned} \text{Mass (g) of KNO}_3 &= (56.6 \text{ kg O}_2) \left( \frac{10^3 \text{ g}}{1 \text{ kg}} \right) \left( \frac{1 \text{ mol O}_2}{32.00 \text{ g O}_2} \right) \left( \frac{4 \text{ mol KNO}_3}{5 \text{ mol O}_2} \right) \left( \frac{101.11 \text{ g KNO}_3}{1 \text{ mol KNO}_3} \right) \\ &= 143070.65 = \mathbf{1.43 \times 10^5 \text{ g KNO}_3} \end{aligned}$$



- 3.43 Plan: Convert mass of  $\text{Cr}_2\text{S}_3$  to moles by dividing by its molar mass. Use the mole ratio between  $\text{Cr}_2\text{S}_3$  and  $\text{Cr}_2\text{O}_3$  from the balanced chemical equation to determine the moles of  $\text{Cr}_2\text{O}_3$  required. Multiply the moles of  $\text{Cr}_2\text{O}_3$  by its molar mass to obtain the mass in grams.

Solution:

$$\text{a) Moles of } \text{Cr}_2\text{S}_3 = (421 \text{ g } \text{Cr}_2\text{S}_3) \left( \frac{1 \text{ mol } \text{Cr}_2\text{S}_3}{200.21 \text{ g } \text{Cr}_2\text{S}_3} \right) = 2.102792 \text{ mol } \text{Cr}_2\text{S}_3$$

$$\text{Moles of } \text{Cr}_2\text{O}_3 = (2.102792 \text{ mol } \text{Cr}_2\text{S}_3) \left( \frac{1 \text{ mol } \text{Cr}_2\text{O}_3}{1 \text{ mol } \text{Cr}_2\text{S}_3} \right) = 2.102792 = \mathbf{2.10 \text{ mol } \text{Cr}_2\text{O}_3}$$

$$\text{b) Mass (g) of } \text{Cr}_2\text{O}_3 = (2.102792 \text{ mol } \text{Cr}_2\text{O}_3) \left( \frac{152.00 \text{ g } \text{Cr}_2\text{O}_3}{1 \text{ mol } \text{Cr}_2\text{O}_3} \right) = 319.624 = \mathbf{3.20 \times 10^2 \text{ g } \text{Cr}_2\text{O}_3}$$

Combining all steps gives:

$$\begin{aligned} \text{Mass (g) of } \text{Cr}_2\text{O}_3 &= (421 \text{ g } \text{Cr}_2\text{S}_3) \left( \frac{1 \text{ mol } \text{Cr}_2\text{S}_3}{200.21 \text{ g } \text{Cr}_2\text{S}_3} \right) \left( \frac{1 \text{ mol } \text{Cr}_2\text{O}_3}{1 \text{ mol } \text{Cr}_2\text{S}_3} \right) \left( \frac{152.00 \text{ g } \text{Cr}_2\text{O}_3}{1 \text{ mol } \text{Cr}_2\text{O}_3} \right) \\ &= 319.624 = \mathbf{3.20 \times 10^2 \text{ g } \text{Cr}_2\text{O}_3} \end{aligned}$$

- 3.44 Plan: First, balance the equation. Convert the grams of diborane to moles of diborane by dividing by its molar mass. Use mole ratios from the balanced chemical equation to determine the moles of the products. Multiply the mole amount of each product by its molar mass to obtain mass in grams.

Solution:

The balanced equation is:  $\text{B}_2\text{H}_6(\text{g}) + 6\text{H}_2\text{O}(\text{l}) \rightarrow 2\text{H}_3\text{BO}_3(\text{s}) + 6\text{H}_2(\text{g})$ .

$$\text{Moles of } \text{B}_2\text{H}_6 = (43.82 \text{ g } \text{B}_2\text{H}_6) \left( \frac{1 \text{ mol } \text{B}_2\text{H}_6}{27.67 \text{ g } \text{B}_2\text{H}_6} \right) = 1.583665 \text{ mol } \text{B}_2\text{H}_6$$

$$\text{Moles of } \text{H}_3\text{BO}_3 = (1.583665 \text{ mol } \text{B}_2\text{H}_6) \left( \frac{2 \text{ mol } \text{H}_3\text{BO}_3}{1 \text{ mol } \text{B}_2\text{H}_6} \right) = 3.16733 \text{ mol } \text{H}_3\text{BO}_3$$

$$\text{Mass (g) of } \text{H}_3\text{BO}_3 = (3.16733 \text{ mol } \text{H}_3\text{BO}_3) \left( \frac{61.83 \text{ g } \text{H}_3\text{BO}_3}{1 \text{ mol } \text{H}_3\text{BO}_3} \right) = 195.83597 = \mathbf{195.8 \text{ g } \text{H}_3\text{BO}_3}$$

Combining all steps gives:

$$\begin{aligned} \text{Mass (g) of } \text{H}_3\text{BO}_3 &= (43.82 \text{ g } \text{B}_2\text{H}_6) \left( \frac{1 \text{ mol } \text{B}_2\text{H}_6}{27.67 \text{ g } \text{B}_2\text{H}_6} \right) \left( \frac{2 \text{ mol } \text{H}_3\text{BO}_3}{1 \text{ mol } \text{B}_2\text{H}_6} \right) \left( \frac{61.83 \text{ g } \text{H}_3\text{BO}_3}{1 \text{ mol } \text{H}_3\text{BO}_3} \right) \\ &= 195.83597 = \mathbf{195.8 \text{ g } \text{H}_3\text{BO}_3} \end{aligned}$$

$$\text{Moles of } \text{H}_2 = (1.583665 \text{ mol } \text{B}_2\text{H}_6) \left( \frac{6 \text{ mol } \text{H}_2}{1 \text{ mol } \text{B}_2\text{H}_6} \right) = 9.50199 \text{ mol } \text{H}_2$$

$$\text{Mass (g) of } \text{H}_2 = (9.50199 \text{ mol } \text{H}_2) \left( \frac{2.016 \text{ g } \text{H}_2}{1 \text{ mol } \text{H}_2} \right) = 19.15901 \text{ g } \text{H}_2 = \mathbf{19.16 \text{ g } \text{H}_2}$$

Combining all steps gives:

$$\text{Mass (g) of } \text{H}_2 = (43.82 \text{ g } \text{B}_2\text{H}_6) \left( \frac{1 \text{ mol } \text{B}_2\text{H}_6}{27.67 \text{ g } \text{B}_2\text{H}_6} \right) \left( \frac{6 \text{ mol } \text{H}_2}{1 \text{ mol } \text{B}_2\text{H}_6} \right) \left( \frac{2.016 \text{ g } \text{H}_2}{1 \text{ mol } \text{H}_2} \right) = 19.15601 = \mathbf{19.16 \text{ g } \text{H}_2}$$

- 3.45 Plan: First, balance the equation. Convert the grams of silver sulfide to moles of silver sulfide by dividing by its molar mass. Use mole ratios from the balanced chemical equation to determine the moles of the products. Multiply the mole amount of each product by its molar mass to obtain mass in grams.

Solution:

First, balance the equation:  $\text{Ag}_2\text{S}(\text{s}) + 2 \text{HCl}(\text{aq}) \rightarrow 2 \text{AgCl}(\text{s}) + \text{H}_2\text{S}(\text{g})$

$$\text{Moles of Ag}_2\text{S} = (174 \text{ g Ag}_2\text{S}) \left( \frac{1 \text{ mol Ag}_2\text{S}}{247.9 \text{ g Ag}_2\text{S}} \right) = 0.7018959 \text{ mol Ag}_2\text{S}$$

$$\text{Moles of AgCl} = (0.7018959 \text{ mol Ag}_2\text{S}) \left( \frac{2 \text{ mol AgCl}}{1 \text{ mol Ag}_2\text{S}} \right) = 1.403792 \text{ mol AgCl}$$

$$\text{Mass (g) of AgCl} = (1.403792 \text{ mol Ag}_2\text{S}) \left( \frac{143.4 \text{ g AgCl}}{1 \text{ mol AgCl}} \right) = 201.304 = \mathbf{201 \text{ g AgCl}}$$

Combining all steps gives:

$$\text{Mass (g) AgCl} = (174 \text{ g Ag}_2\text{S}) \left( \frac{1 \text{ mol Ag}_2\text{S}}{247.9 \text{ g Ag}_2\text{S}} \right) \left( \frac{2 \text{ mol AgCl}}{1 \text{ mol Ag}_2\text{S}} \right) \left( \frac{143.4 \text{ g AgCl}}{1 \text{ mol AgCl}} \right) = 201.304 = \mathbf{201 \text{ g AgCl}}$$

$$\text{Moles of H}_2\text{S} = (0.7018959 \text{ mol Ag}_2\text{S}) \left( \frac{1 \text{ mol H}_2\text{S}}{1 \text{ mol Ag}_2\text{S}} \right) = 0.7018959 \text{ mol H}_2\text{S}$$

$$\text{Mass (g) of H}_2\text{S} = 0.7018959 \text{ mol H}_2\text{S} \left( \frac{34.09 \text{ g H}_2\text{S}}{1 \text{ mol H}_2\text{S}} \right) = 23.9276 = \mathbf{23.9 \text{ g H}_2\text{S}}$$

Combining all steps gives:

$$\text{Mass (g) of H}_2\text{S} = 174 \text{ g Ag}_2\text{S} \left( \frac{1 \text{ mol Ag}_2\text{S}}{247.9 \text{ g Ag}_2\text{S}} \right) \left( \frac{1 \text{ mol H}_2\text{S}}{1 \text{ mol Ag}_2\text{S}} \right) \left( \frac{34.09 \text{ g H}_2\text{S}}{1 \text{ mol H}_2\text{S}} \right) = 23.9276 = \mathbf{23.9 \text{ g H}_2\text{S}}$$

- 3.46 **Plan:** Write the balanced equation by first writing the formulas for the reactants and products. Convert the mass of phosphorus to moles by dividing by the molar mass, use the mole ratio between phosphorus and chlorine from the balanced chemical equation to obtain moles of chlorine, and finally divide the moles of chlorine by its molar mass to obtain amount in grams.

**Solution:**

Reactants: formula for phosphorus is given as  $\text{P}_4$  and formula for chlorine gas is  $\text{Cl}_2$  (chlorine occurs as a diatomic molecule). Product: formula for phosphorus pentachloride (the name indicates one phosphorus atom and five chlorine atoms) is  $\text{PCl}_5$ .

Equation:  $\text{P}_4 + \text{Cl}_2 \rightarrow \text{PCl}_5$

Balancing the equation:  $\text{P}_4 + 10\text{Cl}_2 \rightarrow 4\text{PCl}_5$

$$\text{Moles of P}_4 = (455 \text{ g P}_4) \left( \frac{1 \text{ mol P}_4}{123.88 \text{ g P}_4} \right) = 3.67291 \text{ mol P}_4$$

$$\text{Moles of Cl}_2 = (3.67291 \text{ mol P}_4) \left( \frac{10 \text{ mol Cl}_2}{1 \text{ mol P}_4} \right) = 36.7291 \text{ mol Cl}_2$$

$$\text{Mass (g) of Cl}_2 = (36.7291 \text{ mol Cl}_2) \left( \frac{70.90 \text{ g Cl}_2}{1 \text{ mol Cl}_2} \right) = 2604.09 = \mathbf{2.60 \times 10^3 \text{ g Cl}_2}$$

Combining all steps gives:

$$\text{Mass (g) of Cl}_2 = (455 \text{ g P}_4) \left( \frac{1 \text{ mol P}_4}{123.88 \text{ g P}_4} \right) \left( \frac{10 \text{ mol Cl}_2}{1 \text{ mol P}_4} \right) \left( \frac{70.90 \text{ g Cl}_2}{1 \text{ mol Cl}_2} \right) = 2604.09267 = \mathbf{2.60 \times 10^3 \text{ g Cl}_2}$$

- 3.47 **Plan:** Write the balanced equation by first writing the formulas for the reactants and products. Convert the mass of sulfur to moles by dividing by the molar mass, use the mole ratio between sulfur and fluorine from the balanced chemical equation to obtain moles of fluorine, and finally divide the moles of fluorine by its molar mass to obtain amount in grams.

**Solution:**

Reactants: formula for sulfur is given as  $\text{S}_8$  and formula for fluorine gas is  $\text{F}_2$  (fluorine occurs as a diatomic molecule). Product: formula for sulfur hexafluoride (the name indicates one sulfur atom and six fluoride atoms) is  $\text{SF}_6$ .

Equation:  $\text{S}_8 + \text{F}_2 \rightarrow \text{SF}_6$

Balancing the equation:  $\text{S}_8(s) + 24\text{F}_2(g) \rightarrow 8\text{SF}_6(s)$

$$\text{Moles of S}_8 = (17.8 \text{ g S}_8) \left( \frac{1 \text{ mol S}_8}{256.56 \text{ g S}_8} \right) = 0.0693795 \text{ mol S}_8$$

$$\text{Moles of F}_2 = (0.0693795 \text{ mol S}_8) \left( \frac{24 \text{ mol F}_2}{1 \text{ mol S}_8} \right) = 1.665108 \text{ mol F}_2$$

$$\text{Mass (g) of F}_2 = (1.665108 \text{ mol F}_2) \left( \frac{38.00 \text{ g F}_2}{1 \text{ mol F}_2} \right) = 63.274 = \mathbf{63.3 \text{ g F}_2}$$

Combining all steps gives:

$$\text{Mass (g) of F}_2 = (17.8 \text{ g S}_8) \left( \frac{1 \text{ mol S}_8}{256.56 \text{ g S}_8} \right) \left( \frac{24 \text{ mol F}_2}{1 \text{ mol S}_8} \right) \left( \frac{38.00 \text{ g F}_2}{1 \text{ mol F}_2} \right) = 63.27409 = \mathbf{63.3 \text{ g F}_2}$$

- 3.48 Plan: Convert the given mass of each reactant to moles by dividing by the molar mass of that reactant. Use the mole ratio from the balanced chemical equation to find the moles of CaO formed from each reactant, assuming an excess of the other reactant. The reactant that produces fewer moles of CaO is the limiting reactant. Convert the moles of CaO obtained from the limiting reactant to grams using the molar mass.

Solution:

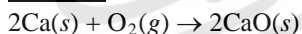

a) Moles of Ca =  $(4.20 \text{ g Ca}) \left( \frac{1 \text{ mol Ca}}{40.08 \text{ g Ca}} \right) = 0.104790 \text{ mol Ca}$

$$\text{Moles of CaO from Ca} = (0.104790 \text{ mol Ca}) \left( \frac{2 \text{ mol CaO}}{2 \text{ mol Ca}} \right) = 0.104790 = \mathbf{0.105 \text{ mol CaO}}$$

b) Moles of O<sub>2</sub> =  $(2.80 \text{ g O}_2) \left( \frac{1 \text{ mol O}_2}{32.00 \text{ g O}_2} \right) = 0.0875 \text{ mol O}_2$

$$\text{Moles of CaO from O}_2 = (0.0875 \text{ mol O}_2) \left( \frac{2 \text{ mol CaO}}{1 \text{ mol O}_2} \right) = 0.17500 = \mathbf{0.175 \text{ mol CaO}}$$

- c) **Calcium** is the limiting reactant since it will form less calcium oxide.  
d) The mass of CaO formed is determined by the limiting reactant, Ca.

$$\text{Mass (g) of CaO} = (0.104790 \text{ mol CaO}) \left( \frac{56.08 \text{ g CaO}}{1 \text{ mol CaO}} \right) = 5.8766 = \mathbf{5.88 \text{ g CaO}}$$

Combining all steps gives:

$$\text{Mass (g) of CaO} = (4.20 \text{ g Ca}) \left( \frac{1 \text{ mol Ca}}{40.08 \text{ g Ca}} \right) \left( \frac{2 \text{ mol CaO}}{2 \text{ mol Ca}} \right) \left( \frac{56.08 \text{ g CaO}}{1 \text{ mol CaO}} \right) = 5.8766 = \mathbf{5.88 \text{ g CaO}}$$

- 3.49 Plan: Convert the given mass of each reactant to moles by dividing by the molar mass of that reactant. Use the mole ratio from the balanced chemical equation to find the moles of H<sub>2</sub> formed from each reactant, assuming an excess of the other reactant. The reactant that produces fewer moles of H<sub>2</sub> is the limiting reactant. Convert the moles of H<sub>2</sub> obtained from the limiting reactant to grams using the molar mass.

Solution:

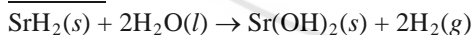

a) Moles of SrH<sub>2</sub> =  $(5.70 \text{ g SrH}_2) \left( \frac{1 \text{ mol SrH}_2}{89.64 \text{ g SrH}_2} \right) = 0.0635877 \text{ mol SrH}_2$

$$\text{Moles of H}_2 \text{ from SrH}_2 = (0.0635877 \text{ mol SrH}_2) \left( \frac{2 \text{ mol H}_2}{1 \text{ mol SrH}_2} \right) = 0.127175 = \mathbf{0.127 \text{ mol H}_2}$$

$$\text{b) Mass (g) of H}_2\text{O} = (4.75 \text{ g H}_2\text{O}) \left( \frac{1 \text{ mol H}_2\text{O}}{18.02 \text{ g H}_2\text{O}} \right) = 0.263596 \text{ mol H}_2\text{O}$$

$$\text{Moles of H}_2 \text{ from H}_2\text{O} = (0.263596 \text{ mol H}_2\text{O}) \left( \frac{2 \text{ mol H}_2}{2 \text{ mol H}_2\text{O}} \right) = 0.263596 = \mathbf{0.264 \text{ mol H}_2}$$

c) **SrH<sub>2</sub>** is the limiting reagent since it will yield fewer moles of hydrogen gas.

d) The mass of H<sub>2</sub> formed is determined by the limiting reactant, SrH<sub>2</sub>.

$$\text{Mass (g) of H}_2 = (0.127175 \text{ mol H}_2) \left( \frac{2.016 \text{ g H}_2}{1 \text{ mol H}_2} \right) = 0.256385 = \mathbf{0.256 \text{ g H}_2}$$

Combining all steps gives:

$$\text{Mass (g) of H}_2 = (5.70 \text{ g SrH}_2) \left( \frac{1 \text{ mol SrH}_2}{89.64 \text{ g SrH}_2} \right) \left( \frac{2 \text{ mol H}_2}{1 \text{ mol SrH}_2} \right) \left( \frac{2.016 \text{ g H}_2}{1 \text{ mol H}_2} \right) = 0.256385 = \mathbf{0.256 \text{ g H}_2}$$

- 3.50 Plan: First, balance the chemical equation. To determine which reactant is limiting, calculate the amount of HIO<sub>3</sub> formed from each reactant, assuming an excess of the other reactant. The reactant that produces less product is the limiting reagent. Use the limiting reagent and the mole ratio from the balanced chemical equation to determine the amount of HIO<sub>3</sub> formed and the amount of the excess reactant that reacts. The difference between the amount of excess reactant that reacts and the initial amount of reactant supplied gives the amount of excess reactant remaining.

Solution:

The balanced chemical equation for this reaction is:



*Hint:* Balance the equation by starting with oxygen. The other elements are in multiple reactants and/or products and are harder to balance initially.

Finding the moles of HIO<sub>3</sub> from the moles of ICl<sub>3</sub> (if H<sub>2</sub>O is limiting):

$$\text{Moles of ICl}_3 = (635 \text{ g ICl}_3) \left( \frac{1 \text{ mol ICl}_3}{233.2 \text{ g ICl}_3} \right) = 2.722985 \text{ mol ICl}_3$$

$$\text{Moles of HIO}_3 \text{ from ICl}_3 = (2.722985 \text{ mol ICl}_3) \left( \frac{1 \text{ mol HIO}_3}{2 \text{ mol ICl}_3} \right) = 1.361492 = \mathbf{1.36 \text{ mol HIO}_3}$$

Finding the moles of HIO<sub>3</sub> from the moles of H<sub>2</sub>O (if ICl<sub>3</sub> is limiting):

$$\text{Moles of H}_2\text{O} = (118.5 \text{ g H}_2\text{O}) \left( \frac{1 \text{ mol H}_2\text{O}}{18.02 \text{ g H}_2\text{O}} \right) = 6.57603 \text{ mol H}_2\text{O}$$

$$\text{Moles HIO}_3 \text{ from H}_2\text{O} = (6.57603 \text{ mol H}_2\text{O}) \left( \frac{1 \text{ mol HIO}_3}{3 \text{ mol H}_2\text{O}} \right) = 2.19201 = \mathbf{2.19 \text{ mol HIO}_3}$$

ICl<sub>3</sub> is the limiting reagent and will produce **1.36 mol HIO<sub>3</sub>**.

$$\text{Mass (g) of HIO}_3 = (1.361492 \text{ mol HIO}_3) \left( \frac{175.9 \text{ g HIO}_3}{1 \text{ mol HIO}_3} \right) = 239.486 = \mathbf{239 \text{ g HIO}_3}$$

Combining all steps gives:

$$\text{Mass (g) of HIO}_3 = (635 \text{ g ICl}_3) \left( \frac{1 \text{ mol ICl}_3}{233.2 \text{ g ICl}_3} \right) \left( \frac{1 \text{ mol HIO}_3}{2 \text{ mol ICl}_3} \right) \left( \frac{175.9 \text{ g HIO}_3}{1 \text{ mol HIO}_3} \right) = 239.486 = \mathbf{239 \text{ g HIO}_3}$$

The remaining mass of the excess reagent can be calculated from the amount of H<sub>2</sub>O combining with the limiting reagent.

$$\text{Moles of H}_2\text{O} \text{ required to react with } 635 \text{ g ICl}_3 = (2.722985 \text{ mol ICl}_3) \left( \frac{3 \text{ mol H}_2\text{O}}{2 \text{ mol ICl}_3} \right) = 4.0844775 \text{ mol H}_2\text{O}$$

$$\text{Mass (g) of H}_2\text{O required to react with 635 g ICl}_3 = (4.0844775 \text{ mol H}_2\text{O}) \left( \frac{18.02 \text{ g H}_2\text{O}}{1 \text{ mol H}_2\text{O}} \right) \\ = 73.6023 = 73.6 \text{ g H}_2\text{O reacted}$$

$$\text{Remaining H}_2\text{O} = 118.5 \text{ g} - 73.6 \text{ g} = \mathbf{44.9 \text{ g H}_2\text{O}}$$

- 3.51 **Plan:** First, balance the chemical equation. To determine which reactant is limiting, calculate the amount of H<sub>2</sub>S formed from each reactant, assuming an excess of the other reactant. The reactant that produces less product is the limiting reagent. Use the limiting reagent and the mole ratio from the balanced chemical equation to determine the amount of H<sub>2</sub>S formed and the amount of the excess reactant that reacts. The difference between the amount of excess reactant that reacts and the initial amount of reactant supplied gives the amount of excess reactant remaining.

**Solution:**

The balanced chemical equation for this reaction is:

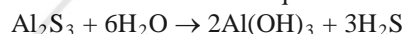

Finding the moles of H<sub>2</sub>S from the moles of Al<sub>2</sub>S<sub>3</sub> (if H<sub>2</sub>O is limiting):

$$\text{Moles of Al}_2\text{S}_3 = (158 \text{ g Al}_2\text{S}_3) \left( \frac{1 \text{ mol Al}_2\text{S}_3}{150.17 \text{ g Al}_2\text{S}_3} \right) = 1.05214 \text{ mol Al}_2\text{S}_3$$

$$\text{Moles of H}_2\text{S from Al}_2\text{S}_3 = (1.05214 \text{ mol Al}_2\text{S}_3) \left( \frac{3 \text{ mol H}_2\text{S}}{1 \text{ mol Al}_2\text{S}_3} \right) = 3.15642 = 3.16 \text{ mol H}_2\text{S}$$

Finding the moles of H<sub>2</sub>S from the moles of H<sub>2</sub>O (if Al<sub>2</sub>S<sub>3</sub> is limiting):

$$\text{Moles of H}_2\text{O} = (131 \text{ g H}_2\text{O}) \left( \frac{1 \text{ mol H}_2\text{O}}{18.02 \text{ g H}_2\text{O}} \right) = 7.26970 \text{ mol H}_2\text{O}$$

$$\text{Moles of H}_2\text{S from H}_2\text{O} = (7.26970 \text{ mol H}_2\text{O}) \left( \frac{3 \text{ mol H}_2\text{S}}{6 \text{ mol H}_2\text{O}} \right) = 3.63485 = 3.63 \text{ mol H}_2\text{S}$$

Al<sub>2</sub>S<sub>3</sub> is the limiting reagent and **3.16 mol of H<sub>2</sub>S** will form.

$$\text{Mass (g) of H}_2\text{S} = (3.15642 \text{ mol H}_2\text{S}) \left( \frac{34.09 \text{ g H}_2\text{S}}{1 \text{ mol H}_2\text{S}} \right) = 107.602 = \mathbf{108 \text{ g H}_2\text{S}}$$

Combining all steps gives:

$$\text{Grams H}_2\text{S} = (158 \text{ g Al}_2\text{S}_3) \left( \frac{1 \text{ mol Al}_2\text{S}_3}{150.17 \text{ g Al}_2\text{S}_3} \right) \left( \frac{3 \text{ mol H}_2\text{S}}{1 \text{ mol Al}_2\text{S}_3} \right) \left( \frac{34.09 \text{ g H}_2\text{S}}{1 \text{ mol H}_2\text{S}} \right) = 107.602 = \mathbf{108 \text{ g H}_2\text{S}}$$

The remaining mass of the excess reagent can be calculated from the amount of H<sub>2</sub>O combining with the limiting reagent.

$$\text{Moles of H}_2\text{O required to react with 158 g of Al}_2\text{S}_3 = (1.05214 \text{ mol Al}_2\text{S}_3) \left( \frac{6 \text{ mol H}_2\text{O}}{1 \text{ mol Al}_2\text{S}_3} \right) = 6.31284 \text{ mol H}_2\text{O}$$

$$\text{Mass (g) of H}_2\text{O required to react with 158 g of Al}_2\text{S}_3 = (6.31284 \text{ mol H}_2\text{O}) \left( \frac{18.02 \text{ g H}_2\text{O}}{1 \text{ mol H}_2\text{O}} \right) = 113.757 \text{ g H}_2\text{O}$$

$$\text{Remaining H}_2\text{O} = 131 \text{ g H}_2\text{O} - 113.757 \text{ g H}_2\text{O} = 17.243 = \mathbf{17 \text{ g H}_2\text{O}}$$

- 3.52 **Plan:** Write the balanced equation; the formula for carbon is C, the formula for oxygen is O<sub>2</sub>, and the formula for carbon dioxide is CO<sub>2</sub>. To determine which reactant is limiting, calculate the amount of CO<sub>2</sub> formed from each reactant, assuming an excess of the other reactant. The reactant that produces less product is the limiting reagent. Use the limiting reagent and the mole ratio from the balanced chemical equation to determine the amount of CO<sub>2</sub> formed and the amount of the excess reactant that reacts. The difference between the amount of excess reactant that reacts and the initial amount of reactant supplied gives the amount of excess reactant remaining.

**Solution:**

The balanced equation is: C(s) + O<sub>2</sub>(g) → CO<sub>2</sub>(g)

Finding the moles of CO<sub>2</sub> from the moles of carbon (if O<sub>2</sub> is limiting):

$$\text{Moles of CO}_2 \text{ from C} = (0.100 \text{ mol C}) \left( \frac{1 \text{ mol CO}_2}{1 \text{ mol C}} \right) = 0.100 \text{ mol CO}_2$$

Finding the moles of CO<sub>2</sub> from the moles of oxygen (if C is limiting):

$$\text{Moles of O}_2 = (8.00 \text{ g O}_2) \left( \frac{1 \text{ mol O}_2}{32.00 \text{ g O}_2} \right) = 0.250 \text{ mol O}_2$$

$$\text{Moles of CO}_2 \text{ from O}_2 = (0.250 \text{ mol O}_2) \left( \frac{1 \text{ mol CO}_2}{1 \text{ mol O}_2} \right) = 0.25000 = 0.250 \text{ mol CO}_2$$

Carbon is the limiting reactant and will be used to determine the amount of CO<sub>2</sub> that will form.

$$\text{Mass (g) of CO}_2 = (0.100 \text{ mol CO}_2) \left( \frac{44.01 \text{ g CO}_2}{1 \text{ mol CO}_2} \right) = 4.401 = \mathbf{4.40 \text{ g CO}_2}$$

Since carbon is limiting, the **O<sub>2</sub> is in excess**. The amount remaining depends on how much combines with the limiting reagent.

$$\text{Moles of O}_2 \text{ required to react with 0.100 mol of C} = (0.100 \text{ mol C}) \left( \frac{1 \text{ mol O}_2}{1 \text{ mol C}} \right) = 0.100 \text{ mol O}_2$$

$$\text{Mass (g) of O}_2 \text{ required to react with 0.100 mol of C} = (0.100 \text{ mol O}_2) \left( \frac{32.00 \text{ g O}_2}{1 \text{ mol O}_2} \right) = 3.20 \text{ g O}_2$$

$$\text{Remaining O}_2 = 8.00 \text{ g} - 3.20 \text{ g} = \mathbf{4.80 \text{ g O}_2}$$

- 3.53 Plan: Write the balanced equation; the formula for hydrogen is H<sub>2</sub>, the formula for oxygen is O<sub>2</sub>, and the formula for water is H<sub>2</sub>O. To determine which reactant is limiting, calculate the amount of H<sub>2</sub>O formed from each reactant, assuming an excess of the other reactant. The reactant that produces less product is the limiting reagent. Use the limiting reagent and the mole ratio from the balanced chemical equation to determine the amount of H<sub>2</sub>O formed and the amount of the excess reactant that reacts. The difference between the amount of excess reactant that reacts and the initial amount of reactant supplied gives the amount of excess reactant remaining.

Solution:

The balanced equation is:  $2\text{H}_2(\text{g}) + \text{O}_2(\text{g}) \rightarrow 2\text{H}_2\text{O}(\text{l})$

Finding the moles of H<sub>2</sub>O from the moles of hydrogen (if O<sub>2</sub> is limiting):

$$\text{Moles of H}_2 = (0.0375 \text{ g H}_2) \left( \frac{1 \text{ mol H}_2}{2.016 \text{ g H}_2} \right) = 0.01860 \text{ mol H}_2$$

$$\text{Moles of H}_2\text{O from H}_2 = (0.01860 \text{ mol H}_2) \left( \frac{2 \text{ mol H}_2\text{O}}{2 \text{ mol H}_2} \right) = 0.01860 = 0.0186 \text{ mol H}_2\text{O}$$

Finding the moles of H<sub>2</sub>O from the moles of oxygen (if H<sub>2</sub> is limiting):

$$\text{Mole of H}_2\text{O from O}_2 = (0.0185 \text{ mol O}_2) \left( \frac{2 \text{ mol H}_2\text{O}}{1 \text{ mol O}_2} \right) = 0.0370 \text{ mol H}_2\text{O}$$

The hydrogen is the limiting reactant, and will be used to determine the amount of water that will form.

$$\text{Mass (g) of H}_2\text{O} = (0.01860 \text{ mol H}_2\text{O}) \left( \frac{18.02 \text{ g H}_2\text{O}}{1 \text{ mol H}_2\text{O}} \right) = 0.335172 = \mathbf{0.335 \text{ g H}_2\text{O}}$$

Since the hydrogen is limiting; the **oxygen must be the excess reactant**. The amount of excess reactant is determined from the limiting reactant.

$$\text{Moles of O}_2 \text{ required to react with 0.0375 g of H}_2 = (0.01860 \text{ mol H}_2) \left( \frac{1 \text{ mol O}_2}{2 \text{ mol H}_2} \right) = 0.00930 \text{ mol O}_2$$

$$\text{Mass (g) of O}_2 \text{ required to react with 0.0375 g of H}_2 = (0.00930 \text{ mol O}_2) \left( \frac{32.00 \text{ g O}_2}{1 \text{ mol O}_2} \right) = 0.2976 \text{ g O}_2$$

$$\text{Mass of O}_2 \text{ supplied} = (0.0185 \text{ mol O}_2) \left( \frac{32.00 \text{ mol O}_2}{1 \text{ mol O}_2} \right) = 0.5920 \text{ g O}_2$$

$$\text{Remaining O}_2 = 0.5920 \text{ g} - 0.2976 \text{ g} = 0.2944 = \mathbf{0.294 \text{ g O}_2}$$

3.54 Plan: The question asks for the mass of each substance present at the end of the reaction. "Substance" refers to both reactants and products. Solve this problem using multiple steps. Recognizing that this is a limiting reactant problem, first write a balanced chemical equation. To determine which reactant is limiting, calculate the amount of any product formed from each reactant, assuming an excess of the other reactant. The reactant that produces less product is the limiting reagent. Any product can be used to predict the limiting reactant; in this case,  $\text{AlCl}_3$  is used. Use the limiting reagent and the mole ratio from the balanced chemical equation to determine the amount of both products formed and the amount of the excess reactant that reacts. The difference between the amount of excess reactant that reacts and the initial amount of reactant supplied gives the amount of excess reactant remaining.

Solution:

The balanced chemical equation is:

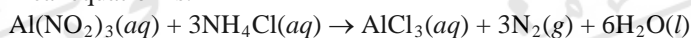

Now determine the limiting reagent. We will use the moles of  $\text{AlCl}_3$  produced to determine which is limiting. Finding the moles of  $\text{AlCl}_3$  from the moles of  $\text{Al}(\text{NO}_2)_3$  (if  $\text{NH}_4\text{Cl}$  is limiting):

$$\text{Moles of Al}(\text{NO}_2)_3 = (72.5 \text{ g Al}(\text{NO}_2)_3) \left( \frac{1 \text{ mol Al}(\text{NO}_2)_3}{165.01 \text{ g Al}(\text{NO}_2)_3} \right) = 0.439367 \text{ mol Al}(\text{NO}_2)_3$$

$$\text{Moles of AlCl}_3 \text{ from Al}(\text{NO}_2)_3 = (0.439367 \text{ mol Al}(\text{NO}_2)_3) \left( \frac{1 \text{ mol AlCl}_3}{1 \text{ mol Al}(\text{NO}_2)_3} \right) = 0.439367 = 0.439 \text{ mol AlCl}_3$$

Finding the moles of  $\text{AlCl}_3$  from the moles of  $\text{NH}_4\text{Cl}$  (if  $\text{Al}(\text{NO}_2)_3$  is limiting):

$$\text{Moles of NH}_4\text{Cl} = (58.6 \text{ g NH}_4\text{Cl}) \left( \frac{1 \text{ mol NH}_4\text{Cl}}{53.49 \text{ g NH}_4\text{Cl}} \right) = 1.09553 \text{ mol NH}_4\text{Cl}$$

$$\text{Moles of AlCl}_3 \text{ from NH}_4\text{Cl} = (1.09553 \text{ mol NH}_4\text{Cl}) \left( \frac{1 \text{ mol AlCl}_3}{3 \text{ mol NH}_4\text{Cl}} \right) = 0.365177 = 0.365 \text{ mol AlCl}_3$$

Ammonium chloride is the limiting reactant, and it is used for all subsequent calculations.

Mass of substances after the reaction:

$\text{Al}(\text{NO}_2)_3$ :

Mass (g) of  $\text{Al}(\text{NO}_2)_3$  (the excess reactant) required to react with 58.6 g of  $\text{NH}_4\text{Cl}$  =

$$(1.09553 \text{ mol NH}_4\text{Cl}) \left( \frac{1 \text{ mol Al}(\text{NO}_2)_3}{3 \text{ mol NH}_4\text{Cl}} \right) \left( \frac{165.01 \text{ g Al}(\text{NO}_2)_3}{1 \text{ mol Al}(\text{NO}_2)_3} \right) = 60.2579 = 60.3 \text{ g Al}(\text{NO}_2)_3$$

$\text{Al}(\text{NO}_2)_3$  remaining:  $72.5 \text{ g} - 60.3 \text{ g} = \mathbf{12.2 \text{ g Al}(\text{NO}_2)_3}$

$\text{NH}_4\text{Cl}$ : **None left** since it is the limiting reagent.

$\text{AlCl}_3$ :

$$\text{Mass (g) of AlCl}_3 = (0.365177 \text{ mol AlCl}_3) \left( \frac{133.33 \text{ g AlCl}_3}{1 \text{ mol AlCl}_3} \right) = 48.689 = \mathbf{48.7 \text{ g AlCl}_3}$$

$\text{N}_2$ :

$$\text{Mass (g) of N}_2 = (1.09553 \text{ mol NH}_4\text{Cl}) \left( \frac{3 \text{ mol N}_2}{3 \text{ mol NH}_4\text{Cl}} \right) \left( \frac{28.02 \text{ g N}_2}{1 \text{ mol N}_2} \right) = 30.697 = \mathbf{30.7 \text{ g N}_2}$$

$\text{H}_2\text{O}$ :

$$\text{Mass (g) of H}_2\text{O} = (1.09553 \text{ mol NH}_4\text{Cl}) \left( \frac{6 \text{ mol H}_2\text{O}}{3 \text{ mol NH}_4\text{Cl}} \right) \left( \frac{18.02 \text{ g H}_2\text{O}}{1 \text{ mol H}_2\text{O}} \right) = 39.483 = \mathbf{39.5 \text{ g H}_2\text{O}}$$

- 3.55 **Plan:** The question asks for the mass of each substance present at the end of the reaction. "Substance" refers to both reactants and products. Solve this problem using multiple steps. Recognizing that this is a limiting reactant problem, first write a balanced chemical equation. To determine which reactant is limiting, calculate the amount of any product formed from each reactant, assuming an excess of the other reactant. The reactant that produces less product is the limiting reagent. Any product can be used to predict the limiting reactant; in this case,  $\text{CaF}_2$  is used. Use the limiting reagent and the mole ratio from the balanced chemical equation to determine the amount of both products formed and the amount of the excess reactant that reacts. The difference between the amount of excess reactant that reacts and the initial amount of reactant supplied gives the amount of excess reactant remaining.

**Solution:**

The balanced chemical equation is:



Now determine the limiting reagent. We will use the moles of  $\text{CaF}_2$  produced to determine which is limiting.

Finding the moles of  $\text{CaF}_2$  from the moles of  $\text{Ca}(\text{NO}_3)_2$  (if  $\text{NH}_4\text{F}$  is limiting):

$$\text{Moles of Ca}(\text{NO}_3)_2 = (16.8 \text{ g Ca}(\text{NO}_3)_2) \left( \frac{1 \text{ mol Ca}(\text{NO}_3)_2}{164.10 \text{ g Ca}(\text{NO}_3)_2} \right) = 0.1023766 \text{ mol Ca}(\text{NO}_3)_2$$

$$\begin{aligned} \text{Moles of CaF}_2 \text{ from Ca}(\text{NO}_3)_2 &= (0.1023766 \text{ mol Ca}(\text{NO}_3)_2) \left( \frac{1 \text{ mol CaF}_2}{1 \text{ mol Ca}(\text{NO}_3)_2} \right) \\ &= 0.1023766 = 0.102 \text{ mol CaF}_2 \end{aligned}$$

Finding the moles of  $\text{CaF}_2$  from the moles of  $\text{NH}_4\text{F}$  (if  $\text{Ca}(\text{NO}_3)_2$  is limiting):

$$\text{Moles of NH}_4\text{F} = (17.50 \text{ g NH}_4\text{F}) \left( \frac{1 \text{ mol NH}_4\text{F}}{37.04 \text{ g NH}_4\text{F}} \right) = 0.47246 \text{ mol NH}_4\text{F}$$

$$\text{Moles of CaF}_2 \text{ from NH}_4\text{F} = (0.47246 \text{ mol NH}_4\text{F}) \left( \frac{1 \text{ mol CaF}_2}{2 \text{ mol NH}_4\text{F}} \right) = 0.23623 = 0.236 \text{ mol CaF}_2$$

Calcium nitrate is the limiting reactant, and it is used for all subsequent calculations

Mass of substances after the reaction:

$\text{Ca}(\text{NO}_3)_2$ : **None** (It is the limiting reactant.)

$\text{NH}_4\text{F}$ :

Mass (g) of  $\text{NH}_4\text{F}$  (the excess reactant) required to react with 16.8 g of  $\text{Ca}(\text{NO}_3)_2$  =

$$(0.1023766 \text{ mol Ca}(\text{NO}_3)_2) \left( \frac{2 \text{ mol NH}_4\text{F}}{1 \text{ mol Ca}(\text{NO}_3)_2} \right) \left( \frac{37.04 \text{ g NH}_4\text{F}}{1 \text{ mol NH}_4\text{F}} \right) = 7.58406 \text{ g Ca}(\text{NO}_3)_2$$

$\text{NH}_4\text{F}$  remaining:  $17.50 \text{ g} - 7.58 \text{ g} = 9.9159 = \mathbf{9.92 \text{ g NH}_4\text{F}}$

$\text{CaF}_2$ :

$$\text{Mass (g) of CaF}_2 = (0.1023766 \text{ mol Ca}(\text{NO}_3)_2) \left( \frac{1 \text{ mol CaF}_2}{1 \text{ mol Ca}(\text{NO}_3)_2} \right) \left( \frac{78.08 \text{ g CaF}_2}{1 \text{ mol CaF}_2} \right) = 7.99356 = \mathbf{7.99 \text{ g CaF}_2}$$

$\text{N}_2\text{O}$ :

$$\text{Mass (g) of N}_2\text{O} = (0.1023766 \text{ mol Ca}(\text{NO}_3)_2) \left( \frac{2 \text{ mol N}_2\text{O}}{1 \text{ mol Ca}(\text{NO}_3)_2} \right) \left( \frac{44.02 \text{ g N}_2\text{O}}{1 \text{ mol N}_2\text{O}} \right) = 9.0132 = \mathbf{9.01 \text{ g N}_2\text{O}}$$

$\text{H}_2\text{O}$ :

$$\text{Mass (g) of H}_2\text{O} = (0.1023766 \text{ mol Ca}(\text{NO}_3)_2) \left( \frac{4 \text{ mol H}_2\text{O}}{1 \text{ mol Ca}(\text{NO}_3)_2} \right) \left( \frac{18.02 \text{ g H}_2\text{O}}{1 \text{ mol H}_2\text{O}} \right) = 7.3793 = \mathbf{7.38 \text{ g H}_2\text{O}}$$

- 3.56 **Plan:** Express the yield of each step as a fraction of 1.00; multiply the fraction of the first step by that of the second step and then multiply by 100 to get the overall percent yield.

**Solution:**

$$73\% = 0.73; 68\% = 0.68$$

$$(0.73 \times 0.68) \times 100 = 49.64 = \mathbf{50.0\%}$$



- 3.57 **Plan:** Express the yield of each step as a fraction of 1.00; multiply the fraction of the first step by that of the second step and then multiply by 100 to get the overall percent yield.

**Solution:**

$$48\% = 0.48; 73\% = 0.73$$

$$(0.48 \times 0.73) \times 100 = 35.04 = \mathbf{35\%}$$

- 3.58 **Plan:** Write and balance the chemical equation using the formulas of the substances. Determine the theoretical yield of the reaction from the mass of tungsten(VI) oxide. To do that, convert the mass of tungsten(VI) oxide to moles by dividing by its molar mass and then use the mole ratio between tungsten(VI) oxide and water to determine the moles and then mass of water that should be produced. Use the density of water to determine the actual yield of water in grams. The actual yield divided by the theoretical yield just calculated (with the result multiplied by 100%) gives the percent yield.

**Solution:**

The balanced chemical equation is:

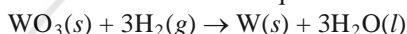

Determining the theoretical yield of  $\text{H}_2\text{O}$ :

$$\text{Moles of } \text{WO}_3 = (45.5 \text{ g } \text{WO}_3) \left( \frac{1 \text{ mol } \text{WO}_3}{231.9 \text{ g } \text{WO}_3} \right) = 0.1962053 \text{ mol } \text{WO}_3$$

$$\text{Mass (g) of } \text{H}_2\text{O (theoretical yield)} = (0.1962053 \text{ mol } \text{WO}_3) \left( \frac{3 \text{ mol } \text{H}_2\text{O}}{1 \text{ mol } \text{WO}_3} \right) \left( \frac{18.02 \text{ g } \text{H}_2\text{O}}{1 \text{ mol } \text{H}_2\text{O}} \right) = 10.60686 \text{ g } \text{H}_2\text{O}$$

Determining the actual yield of  $\text{H}_2\text{O}$ :

$$\text{Mass (g) of } \text{H}_2\text{O (actual yield)} = (9.60 \text{ mL } \text{H}_2\text{O}) \left( \frac{1.00 \text{ g } \text{H}_2\text{O}}{1 \text{ mL } \text{H}_2\text{O}} \right) = 9.60 \text{ g } \text{H}_2\text{O}$$

$$\% \text{ yield} = \left( \frac{\text{actual Yield}}{\text{theoretical Yield}} \right) \times 100\% = \left( \frac{9.60 \text{ g } \text{H}_2\text{O}}{10.60686 \text{ g } \text{H}_2\text{O}} \right) \times 100\% = 90.5075 = \mathbf{90.5\%}$$

- 3.59 **Plan:** Write and balance the chemical equation using the formulas of the substances. Determine the theoretical yield of the reaction from the mass of phosphorus trichloride. To do that, convert the mass of phosphorus trichloride to moles by dividing by its molar mass and then use the mole ratio between phosphorus trichloride and HCl to determine the moles and then mass of HCl that should be produced. The actual yield of the HCl is given. The actual yield divided by the theoretical yield just calculated (with the result multiplied by 100%) gives the percent yield.

**Solution:**

The balanced chemical equation is:

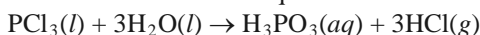

Determining the theoretical yield of HCl:

$$\text{Moles of } \text{PCl}_3 = (200. \text{ g } \text{PCl}_3) \left( \frac{1 \text{ mol } \text{PCl}_3}{137.32 \text{ g } \text{PCl}_3} \right) = 1.456452 \text{ mol } \text{PCl}_3$$

$$\text{Mass (g) of } \text{HCl (theoretical yield)} = (1.456452 \text{ mol } \text{PCl}_3) \left( \frac{3 \text{ mol } \text{HCl}}{1 \text{ mol } \text{PCl}_3} \right) \left( \frac{36.46 \text{ g } \text{HCl}}{1 \text{ mol } \text{HCl}} \right) = 159.3067 \text{ g } \text{HCl}$$

Actual yield (g) of HCl is given as 128 g HCl.

Calculate the percent yield:

$$\% \text{ yield} = \left( \frac{\text{actual Yield}}{\text{theoretical Yield}} \right) \times 100\% = \left( \frac{128 \text{ g } \text{HCl}}{159.3067 \text{ g } \text{HCl}} \right) \times 100\% = 80.3481586 = \mathbf{80.3\%}$$

- 3.60 Plan: Write the balanced chemical equation. Since quantities of two reactants are given, we must determine which is the limiting reactant. To determine which reactant is limiting, calculate the amount of any product formed from each reactant, assuming an excess of the other reactant. The reactant that produces less product is the limiting reagent. Any product can be used to predict the limiting reactant; in this case, CH<sub>3</sub>Cl is used. Only 75.0% of the calculated amounts of products actually form, so the actual yield is 75% of the theoretical yield.

Solution:

The balanced equation is:  $\text{CH}_4(g) + \text{Cl}_2(g) \rightarrow \text{CH}_3\text{Cl}(g) + \text{HCl}(g)$

Determining the limiting reactant:

Finding the moles of CH<sub>3</sub>Cl from the moles of CH<sub>4</sub> (if Cl<sub>2</sub> is limiting):

$$\text{Moles of CH}_4 = (20.5 \text{ g CH}_4) \left( \frac{1 \text{ mol CH}_4}{16.04 \text{ g CH}_4} \right) = 1.278055 \text{ mol CH}_4$$

$$\text{Moles of CH}_3\text{Cl from CH}_4 = (1.278055 \text{ mol CH}_4) \left( \frac{1 \text{ mol CH}_3\text{Cl}}{1 \text{ mol CH}_4} \right) = 1.278055 \text{ mol CH}_3\text{Cl}$$

Finding the moles of CH<sub>3</sub>Cl from the moles of Cl<sub>2</sub> (if CH<sub>4</sub> is limiting):

$$\text{Moles of Cl}_2 = (45.0 \text{ g Cl}_2) \left( \frac{1 \text{ mol Cl}_2}{70.90 \text{ g Cl}_2} \right) = 0.634697 \text{ mol Cl}_2$$

$$\text{Moles of CH}_3\text{Cl from Cl}_2 = (0.634697 \text{ mol Cl}_2) \left( \frac{1 \text{ mol CH}_3\text{Cl}}{1 \text{ mol Cl}_2} \right) = 0.634697 \text{ mol CH}_3\text{Cl}$$

Chlorine is the limiting reactant and is used to determine the theoretical yield of CH<sub>3</sub>Cl:

$$\text{Mass (g) of CH}_3\text{Cl (theoretical yield)} = (0.634697 \text{ mol CH}_3\text{Cl}) \left( \frac{50.48 \text{ g CH}_3\text{Cl}}{1 \text{ mol CH}_3\text{Cl}} \right) = 32.0395 \text{ g CH}_3\text{Cl}$$

$$\% \text{ yield} = \left( \frac{\text{actual Yield}}{\text{theoretical Yield}} \right) \times 100\%$$

$$\text{Actual yield (g) of CH}_3\text{Cl} = \frac{\% \text{ yield}}{100\%} (\text{theoretical yield}) = \frac{75\%}{100\%} (32.0395 \text{ g CH}_3\text{Cl}) = 24.02962 = \mathbf{24.0 \text{ g CH}_3\text{Cl}}$$

- 3.61 Plan: Write the balanced chemical equation. Since quantities of two reactants are given, we must determine which is the limiting reactant. To determine which reactant is limiting, calculate the amount of product formed from each reactant, assuming an excess of the other reactant. Only 93.0% of the calculated amount of product actually forms, so the actual yield is 93.0% of the theoretical yield.

Solution:

The balanced equation is:  $3\text{Ca}(s) + \text{N}_2(g) \rightarrow \text{Ca}_3\text{N}_2(s)$

Determining the limiting reactant:

Finding the moles of Ca<sub>3</sub>N<sub>2</sub> from the moles of Ca (if N<sub>2</sub> is limiting):

$$\text{Moles of Ca} = (56.6 \text{ g Ca}) \left( \frac{1 \text{ mol Ca}}{40.08 \text{ g Ca}} \right) = 1.412176 \text{ mol Ca}$$

$$\text{Moles of Ca}_3\text{N}_2 \text{ from Ca} = (1.412176 \text{ mol Ca}) \left( \frac{1 \text{ mol Ca}_3\text{N}_2}{3 \text{ mol Ca}} \right) = 0.470725 \text{ mol Ca}_3\text{N}_2$$

Finding the moles of Ca<sub>3</sub>N<sub>2</sub> from the moles of N<sub>2</sub> (if Ca is limiting):

$$\text{Moles of N}_2 = (30.5 \text{ g N}_2) \left( \frac{1 \text{ mol N}_2}{28.02 \text{ g N}_2} \right) = 1.08851 \text{ mol N}_2$$

$$\text{Moles of Ca}_3\text{N}_2 \text{ from N}_2 = (1.08851 \text{ mol N}_2) \left( \frac{1 \text{ mol Ca}_3\text{N}_2}{1 \text{ mol N}_2} \right) = 1.08851 \text{ mol Ca}_3\text{N}_2$$

Ca is the limiting reactant and is used to determine the theoretical yield of Ca<sub>3</sub>N<sub>2</sub>.

$$\text{Mass (g) of Ca}_3\text{N}_2 \text{ (theoretical yield)} = (0.470725 \text{ mol Ca}_3\text{N}_2) \left( \frac{148.26 \text{ g Ca}_3\text{N}_2}{1 \text{ mol Ca}_3\text{N}_2} \right) = 69.7897 \text{ g Ca}_3\text{N}_2$$

$$\% \text{ yield} = \left( \frac{\text{actual Yield}}{\text{theoretical Yield}} \right) \times 100\%$$

$$\text{Actual yield (g) of Ca}_3\text{N}_2 = \frac{\% \text{ yield}}{100\%} (\text{theoretical yield}) = \frac{93\%}{100\%} (69.7897 \text{ g Ca}_3\text{N}_2) = 64.9044 = \mathbf{64.9 \text{ g Ca}_3\text{N}_2}$$

- 3.62 Plan: Write the balanced equation; the formula for fluorine is  $\text{F}_2$ , the formula for carbon tetrafluoride is  $\text{CF}_4$ , and the formula for nitrogen trifluoride is  $\text{NF}_3$ . To determine which reactant is limiting, calculate the amount of  $\text{CF}_4$  formed from each reactant, assuming an excess of the other reactant. The reactant that produces less product is the limiting reagent. Use the limiting reagent and the mole ratio from the balanced chemical equation to determine the mass of  $\text{CF}_4$  formed.

Solution:

The balanced chemical equation is:

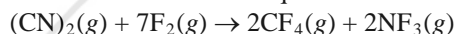

Determining the limiting reactant:

Finding the moles of  $\text{CF}_4$  from the moles of  $(\text{CN})_2$  (if  $\text{F}_2$  is limiting):

$$\text{Moles of CF}_4 \text{ from } (\text{CN})_2 = (60.0 \text{ g } (\text{CN})_2) \left( \frac{1 \text{ mol } (\text{CN})_2}{52.04 \text{ g } (\text{CN})_2} \right) \left( \frac{2 \text{ mol CF}_4}{1 \text{ mol } (\text{CN})_2} \right) = 2.30592 \text{ mol CF}_4$$

Finding the moles of  $\text{CF}_4$  from the moles of  $\text{F}_2$  (if  $(\text{CN})_2$  is limiting):

$$\text{Moles of CF}_4 \text{ from F}_2 = (60.0 \text{ g F}_2) \left( \frac{1 \text{ mol F}_2}{38.00 \text{ g F}_2} \right) \left( \frac{2 \text{ mol CF}_4}{7 \text{ mol F}_2} \right) = 0.4511278 \text{ mol CF}_4$$

$\text{F}_2$  is the limiting reactant, and will be used to calculate the amount of  $\text{CF}_4$  produced.

$$\text{Mass (g) of CF}_4 = (60.0 \text{ g F}_2) \left( \frac{1 \text{ mol F}_2}{38.00 \text{ g F}_2} \right) \left( \frac{2 \text{ mol CF}_4}{7 \text{ mol F}_2} \right) \left( \frac{88.01 \text{ g CF}_4}{1 \text{ mol CF}_4} \right) = 39.70376 = \mathbf{39.7 \text{ g CF}_4}$$

- 3.63 Plan: Write and balance the chemical reaction. Remember that both chlorine and oxygen exist as diatomic molecules. Use the mole ratio between oxygen and dichlorine monoxide to find the moles of dichlorine monoxide that reacted. Multiply the amount in moles by Avogadro's number to convert to number of molecules.

Solution:

a) Both oxygen and chlorine are diatomic. **Scene A** best represents the product mixture as there are  $\text{O}_2$  and  $\text{Cl}_2$  molecules in Scene A. Scene B shows oxygen and chlorine atoms and Scene C shows atoms and molecules.

Oxygen and chlorine atoms are NOT products of this reaction.

b) The balanced reaction is  $2\text{Cl}_2\text{O}(\text{g}) \rightarrow 2\text{Cl}_2(\text{g}) + \text{O}_2(\text{g})$ .

c) There is a 2:1 mole ratio between  $\text{Cl}_2$  and  $\text{O}_2$ . In Scene A, there are 6 green molecules and 3 red molecules. Since twice as many  $\text{Cl}_2$  molecules are produced as there are  $\text{O}_2$  molecules produced, the red molecules are the  $\text{O}_2$  molecules.

$$\begin{aligned} \text{Moles of Cl}_2\text{O} &= (3 \text{ O}_2 \text{ molecules}) \left( \frac{2 \text{ O atoms}}{1 \text{ O}_2 \text{ molecule}} \right) \left( \frac{0.050 \text{ mol O atoms}}{1 \text{ O atom}} \right) \left( \frac{1 \text{ mol O}_2 \text{ molecules}}{2 \text{ mol O atoms}} \right) \left( \frac{2 \text{ mol Cl}_2\text{O}}{1 \text{ mol O}_2} \right) \\ &= 0.30 \text{ mol Cl}_2\text{O} \end{aligned}$$

$$\begin{aligned} \text{Molecules of Cl}_2\text{O} &= (0.30 \text{ mol Cl}_2\text{O}) \left( \frac{6.022 \times 10^{23} \text{ Cl}_2\text{O molecules}}{1 \text{ mol Cl}_2\text{O}} \right) \\ &= 1.8066 \times 10^{23} = \mathbf{1.8 \times 10^{23} \text{ Cl}_2\text{O molecules}} \end{aligned}$$

- 3.64 Plan: Write a balanced equation. Use the density of butane to convert the given volume of butane to mass and divide by the molar mass of butane to convert mass to moles. Use the mole ratio between butane and oxygen to find the moles and then mass of oxygen required for the reaction. The mole ratio between butane and water is used to find the moles of water produced and the mole ratio between butane and carbon dioxide is used to find the moles of carbon dioxide produced. The total moles of product are multiplied by Avogadro's number to find the number of product molecules.

Solution:

The balanced chemical equation is:

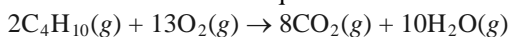

$$\text{a) Moles of C}_4\text{H}_{10} = (5.50 \text{ mL C}_4\text{H}_{10}) \left( \frac{0.579 \text{ g C}_4\text{H}_{10}}{1 \text{ mL C}_4\text{H}_{10}} \right) \left( \frac{1 \text{ mol C}_4\text{H}_{10}}{58.12 \text{ g C}_4\text{H}_{10}} \right) = 0.054792 \text{ mol C}_4\text{H}_{10}$$

$$\text{Mass (g) of O}_2 = (0.054792 \text{ mol C}_4\text{H}_{10}) \left( \frac{13 \text{ mol O}_2}{2 \text{ mol C}_4\text{H}_{10}} \right) \left( \frac{32.00 \text{ g O}_2}{1 \text{ mol O}_2} \right) = 11.3967 = \mathbf{11.4 \text{ g O}_2}$$

$$\text{b) Moles of H}_2\text{O} = (0.054792 \text{ mol C}_4\text{H}_{10}) \left( \frac{10 \text{ mol H}_2\text{O}}{2 \text{ mol C}_4\text{H}_{10}} \right) = 0.27396 = \mathbf{0.274 \text{ mol H}_2\text{O}}$$

$$\text{c) Moles of CO}_2 = (0.054792 \text{ mol C}_4\text{H}_{10}) \left( \frac{8 \text{ mol CO}_2}{2 \text{ mol C}_4\text{H}_{10}} \right) = 0.219168 \text{ mol CO}_2$$

$$\text{Total moles} = 0.27396 \text{ mol H}_2\text{O} + 0.219168 \text{ mol CO}_2 = 0.493128 \text{ mol}$$

$$\text{Total molecules} = (0.493128 \text{ mol}) \left( \frac{6.022 \times 10^{23} \text{ molecules}}{1 \text{ mol}} \right) = 2.96962 \times 10^{23} = \mathbf{2.97 \times 10^{23} \text{ molecules}}$$

- 3.65 Plan: Write a balanced equation for the reaction. Convert the given mass of each reactant to moles by dividing by the molar mass of that reactant. Use the mole ratio from the balanced chemical equation to find the moles of NaBH<sub>4</sub> formed from each reactant, assuming an excess of the other reactant. The reactant that produces fewer moles of product is the limiting reactant. Convert the moles of NaBH<sub>4</sub> obtained from the limiting reactant to grams using the molar mass. This is the theoretical yield of NaBH<sub>4</sub>. Since there is a yield of 88.5%, the amount of NaBH<sub>4</sub> actually obtained will be 88.5% of the theoretical yield.

Solution:

The balanced chemical equation is:

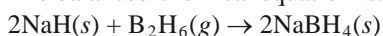

Determining the limiting reactant:

Finding the moles of NaBH<sub>4</sub> from the amount of NaH (if B<sub>2</sub>H<sub>6</sub> is limiting):

$$\text{Moles of NaBH}_4 \text{ from NaH} = (7.98 \text{ g NaH}) \left( \frac{1 \text{ mol NaH}}{24.00 \text{ g NaH}} \right) \left( \frac{2 \text{ mol NaBH}_4}{2 \text{ mol NaH}} \right) = 0.3325 \text{ mol NaBH}_4$$

Finding the moles of NaBH<sub>4</sub> from the amount of B<sub>2</sub>H<sub>6</sub> (if NaH is limiting):

$$\text{Moles of NaBH}_4 \text{ from B}_2\text{H}_6 = (8.16 \text{ g B}_2\text{H}_6) \left( \frac{1 \text{ mol B}_2\text{H}_6}{27.67 \text{ g B}_2\text{H}_6} \right) \left( \frac{2 \text{ mol NaBH}_4}{1 \text{ mol B}_2\text{H}_6} \right) = 0.58981 \text{ mol NaBH}_4$$

NaH is the limiting reactant, and will be used to calculate the theoretical yield of NaBH<sub>4</sub>.

$$\text{Mass (g) of NaBH}_4 = (0.3325 \text{ mol NaBH}_4) \left( \frac{37.83 \text{ g NaBH}_4}{1 \text{ mol NaBH}_4} \right) = 12.5785 \text{ g NaBH}_4$$

$$\% \text{ yield} = \left( \frac{\text{actual Yield}}{\text{theoretical Yield}} \right) \times 100\%$$

$$\text{Mass (g) of NaBH}_4 = \left( \frac{\% \text{ yield}}{100\%} \right) (\text{theoretical yield}) = \left( \frac{88.5\%}{100\%} \right) (12.5785 \text{ g NaBH}_4) = 11.13197 = \mathbf{11.1 \text{ g NaBH}_4}$$

Combining all steps gives:

$$\begin{aligned} \text{Mass (g) of NaBH}_4 &= (7.98 \text{ g NaH}) \left( \frac{1 \text{ mol NaH}}{24.00 \text{ g NaH}} \right) \left( \frac{2 \text{ mol NaBH}_4}{2 \text{ mol NaH}} \right) \left( \frac{37.83 \text{ g NaBH}_4}{1 \text{ mol NaBH}_4} \right) \left( \frac{88.5\%}{100\%} \right) \\ &= 11.13197 = \mathbf{11.1 \text{ g NaBH}_4} \end{aligned}$$

- 3.66 Plan: Recall that molarity = moles of solute/volume (L) of solution. Here you can use the number of particles in place of moles of solute.  
Solution:  
 a) **Solution B** has the highest molarity as it has the largest number of particles, 12, in a volume of 50 mL.  
 b) **Solutions A and F** both have 8 particles in a volume of 50 mL and thus the same molarity. **Solutions C, D, and E** all have 4 particles in a volume of 50 mL and thus have the same molarity.  
 c) Mixing Solutions A and C results in  $8 + 4 = 12$  particles in a volume of 100 mL. That is a **lower molarity** than that of Solution B which has 12 particles in a volume of 50 mL or 24 particles in a volume of 100 mL.  
 d) Adding 50 mL to Solution D would result in 4 particles in a total volume of 100 mL; adding 75 mL to Solution F would result in 4 particles in a volume of 100 mL. The molarity of each solution would be the **same**.  
 e) Solution A has 8 particles in a volume of 50 mL while Solution E has the equivalent of 4 particles in a volume of 50 mL. The molarity of Solution E is half that of Solution A. Therefore **half of the volume, 12.5 mL**, of Solution E must be evaporated. When 12.5 mL of solvent is evaporated from Solution E, the result will be 2 particles in 12.5 mL or 8 particles in 50 mL as in Solution A.

- 3.67 Plan: The spheres represent particles of solute and the amount of *solute* per given volume of *solution* determines its concentration. Molarity = moles of solute/volume (L) of solution.

Solution:

- a) **Box C** has more solute added because it contains 2 more spheres than Box A contains.  
 b) **Box B** has more solvent because solvent molecules have displaced two solute molecules.  
 c) **Box C** has a higher molarity, because it has more moles of solute per volume of solution.  
 d) **Box B** has a lower concentration (and molarity), because it has fewer moles of solute per volume of solution.

- 3.68 Plan: In all cases, use the known quantities and the definition of molarity  $\left( M = \frac{\text{moles solute}}{\text{L of solution}} \right)$  to find the

unknown quantity. Volume must be expressed in liters. The molar mass is used to convert moles to grams. The chemical formulas must be written to determine the molar mass. (a) You will need to convert milliliters to liters, multiply by the molarity to find moles, and convert moles to mass in grams. (b) Convert mass of solute to moles and volume from mL to liters. Divide the moles by the volume. (c) Multiply the molarity by the volume.

Solution:

- a) Calculating moles of solute in solution:

$$\text{Moles of Ca(C}_2\text{H}_3\text{O}_2)_2 = (185.8 \text{ mL}) \left( \frac{10^{-3} \text{ L}}{1 \text{ mL}} \right) \left( \frac{0.267 \text{ mol Ca(C}_2\text{H}_3\text{O}_2)_2}{1 \text{ L}} \right) = 0.0496086 \text{ mol Ca(C}_2\text{H}_3\text{O}_2)_2$$

Converting from moles of solute to grams:

$$\begin{aligned} \text{Mass (g) of Ca(C}_2\text{H}_3\text{O}_2)_2 &= (0.0496086 \text{ mol Ca(C}_2\text{H}_3\text{O}_2)_2) \left( \frac{158.17 \text{ g Ca(C}_2\text{H}_3\text{O}_2)_2}{1 \text{ mol Ca(C}_2\text{H}_3\text{O}_2)_2} \right) \\ &= 7.84659 = \mathbf{7.85 \text{ g Ca(C}_2\text{H}_3\text{O}_2)_2} \end{aligned}$$

- b) Converting grams of solute to moles:

$$\text{Moles of KI} = (21.1 \text{ g KI}) \left( \frac{1 \text{ mol KI}}{166.0 \text{ g KI}} \right) = 0.127108 \text{ moles KI}$$

$$\text{Volume (L)} = (500. \text{ mL}) \left( \frac{10^{-3} \text{ L}}{1 \text{ mL}} \right) = 0.500 \text{ L}$$

$$\text{Molarity of KI} = \frac{0.127108 \text{ mol KI}}{0.500 \text{ L}} = 0.254216 = \mathbf{0.254 \text{ M KI}}$$

c) Moles of NaCN =  $(145.6 \text{ L}) \left( \frac{0.850 \text{ mol NaCN}}{1 \text{ L}} \right) = 123.76 = \mathbf{124 \text{ mol NaCN}}$

3.69 Plan: In all cases, use the known quantities and the definition of molarity  $\left( M = \frac{\text{moles solute}}{\text{L of solution}} \right)$  to find the

unknown quantity. Volume must be expressed in liters. The molar mass is used to convert moles to grams. The chemical formulas must be written to determine the molar mass. (a) You will need to convert mass of solute to moles and divide by the molarity to obtain volume in liters, which is then converted to milliliters. (b) Multiply the volume by the molarity to obtain moles of solute. Use Avogadro's number to determine the number of ions present. (c) Divide mmoles by milliliters; molarity may not only be expressed as moles/L, but also as mmoles/mL.

Solution:

a) Converting mass of solute to moles:

$$\text{Moles of KOH} = (8.42 \text{ g KOH}) \left( \frac{1 \text{ mol KOH}}{56.11 \text{ g KOH}} \right) = 0.15006 \text{ mol KOH}$$

$$\text{Volume (L) of KOH solution} = (0.15006 \text{ mol KOH}) \left( \frac{1 \text{ L}}{2.26 \text{ mol}} \right) = 0.066398 \text{ L KOH solution}$$

$$\text{Volume (mL) of KOH solution} = (0.066398 \text{ L KOH}) \left( \frac{1 \text{ L}}{10^{-3} \text{ mL}} \right) = 66.39823 = \mathbf{66.4 \text{ mL KOH solution}}$$

$$\text{b) Moles of CuCl}_2 = (52 \text{ L}) \left( \frac{2.3 \text{ mol CuCl}_2}{\text{L}} \right) = 119.6 \text{ mol CuCl}_2$$

$$\text{Moles of Cu}^{2+} \text{ ions} = (119.6 \text{ mol CuCl}_2) \left( \frac{1 \text{ mol Cu}^{2+}}{1 \text{ mol CuCl}_2} \right) = 119.6 \text{ mol Cu}^{2+} \text{ ions}$$

Converting moles of ions to number of ions:

$$\text{Number of Cu}^{2+} \text{ ions} = (119.6 \text{ mol Cu}^{2+} \text{ ions}) \left( \frac{6.022 \times 10^{23} \text{ Cu}^{2+} \text{ ions}}{1 \text{ mol Cu}^{2+} \text{ ions}} \right) = 7.2023 \times 10^{25} = \mathbf{7.2 \times 10^{25} \text{ Cu}^{2+} \text{ ions}}$$

$$\text{c) } M \text{ glucose} = \left( \frac{135 \text{ mmol glucose}}{275 \text{ mL}} \right) = 0.490909 = \mathbf{0.491 \text{ M glucose}}$$

Note: Since 1 mmol is  $10^{-3}$  mol and 1 mL is  $10^{-3}$  L, we can use these units instead of converting to mol and L since molarity is a ratio of mol/L. Molarity may not only be expressed as moles/L, but also as mmoles/mL.

3.70 Plan: These are dilution problems. Dilution problems can be solved by converting to moles and using the new volume; however, it is much easier to use  $M_1V_1 = M_2V_2$ . The dilution equation does not require a volume in liters; it only requires that the volume units match. In part c), it is necessary to find the moles of sodium ions in each separate solution, add these two mole amounts, and divide by the total volume of the two solutions.

Solution:

$$\text{a) } M_1 = 0.250 \text{ M KCl} \quad V_1 = 37.00 \text{ mL} \quad M_2 = ? \quad V_2 = 150.00 \text{ mL}$$

$$M_1V_1 = M_2V_2$$

$$M_2 = \frac{M_1 \times V_1}{V_2} = \frac{(0.250 \text{ M})(37.00 \text{ mL})}{150.0 \text{ mL}} = 0.061667 = \mathbf{0.0617 \text{ M KCl}}$$

$$\text{b) } M_1 = 0.0706 \text{ M (NH}_4)_2\text{SO}_4 \quad V_1 = 25.71 \text{ mL} \quad M_2 = ? \quad V_2 = 500.00 \text{ mL}$$

$$M_1V_1 = M_2V_2$$

$$M_2 = \frac{M_1 \times V_1}{V_2} = \frac{(0.0706 \text{ M})(25.71 \text{ mL})}{500.0 \text{ mL}} = 0.003630 = \mathbf{0.00363 \text{ M (NH}_4)_2\text{SO}_4}$$

$$\text{c) Moles of Na}^+ \text{ from NaCl solution} = (3.58 \text{ mL}) \left( \frac{10^{-3} \text{ L}}{1 \text{ mL}} \right) \left( \frac{0.348 \text{ mol NaCl}}{1 \text{ L}} \right) \left( \frac{1 \text{ mol Na}^+}{1 \text{ mol NaCl}} \right)$$

$$= 0.00124584 \text{ mol Na}^+$$

$$\begin{aligned} \text{Moles of Na}^+ \text{ from Na}_2\text{SO}_4 \text{ solution} &= (500. \text{ mL}) \left( \frac{10^{-3} \text{ L}}{1 \text{ mL}} \right) \left( \frac{6.81 \times 10^{-2} \text{ mol Na}_2\text{SO}_4}{1 \text{ L}} \right) \left( \frac{2 \text{ mol Na}^+}{1 \text{ mol Na}_2\text{SO}_4} \right) \\ &= 0.0681 \text{ mol Na}^+ \end{aligned}$$

$$\text{Total moles of Na}^+ \text{ ions} = 0.00124584 \text{ mol Na}^+ \text{ ions} + 0.0681 \text{ mol Na}^+ \text{ ions} = 0.06934584 \text{ mol Na}^+ \text{ ions}$$

$$\text{Total volume} = 3.58 \text{ mL} + 500. \text{ mL} = 503.58 \text{ mL} = 0.50358 \text{ L}$$

$$\text{Molarity of Na}^+ = \frac{\text{total moles Na}^+ \text{ ions}}{\text{total volume}} = \frac{0.06934584 \text{ mol Na}^+ \text{ ions}}{0.50358 \text{ L}} = 0.1377057 = \mathbf{0.138 \text{ M Na}^+ \text{ ions}}$$

- 3.71 Plan: These are dilution problems. Dilution problems can be solved by converting to moles and using the new volume; however, it is much easier to use  $M_1V_1 = M_2V_2$ . The dilution equation does not require a volume in liters; it only requires that the volume units match.

Solution:

$$\text{a) } M_1 = 2.050 \text{ M Cu(NO}_3)_2 \quad V_1 = ? \quad M_2 = 0.8543 \text{ M Cu(NO}_3)_2 \quad V_2 = 750.0 \text{ mL}$$

$$M_1V_1 = M_2V_2$$

$$V_1 = \frac{M_2 \times V_2}{M_1} = \frac{(0.8543 \text{ M})(750.0 \text{ mL})}{2.050 \text{ M}} = 312.5488 = \mathbf{312.5 \text{ mL}}$$

$$\text{b) } M_1 = 1.63 \text{ M CaCl}_2 \quad M_1 \text{ Cl}^- = \left( \frac{1.63 \text{ mol CaCl}_2}{1 \text{ L}} \right) \left( \frac{2 \text{ mol Cl}^-}{1 \text{ mol CaCl}_2} \right) = 3.26 \text{ M Cl}^- \text{ ions}$$

$$M_1 = 3.26 \text{ M Cl}^- \quad V_1 = ? \quad M_2 = 2.86 \times 10^{-2} \text{ M Cl}^- \text{ ions} \quad V_2 = 350. \text{ mL}$$

$$M_1V_1 = M_2V_2$$

$$V_1 = \frac{M_2 \times V_2}{M_1} = \frac{(2.86 \times 10^{-2} \text{ M})(350. \text{ mL})}{3.26 \text{ M}} = 3.07055 = \mathbf{3.07 \text{ mL}}$$

$$\text{c) } M_1 = 0.155 \text{ M Li}_2\text{CO}_3 \quad V_1 = 18.0 \text{ mL} \quad M_2 = 0.0700 \text{ M Li}_2\text{CO}_3 \quad V_2 = ?$$

$$M_1V_1 = M_2V_2$$

$$V_2 = \frac{M_1 \times V_1}{M_2} = \frac{(0.155 \text{ M})(18.0 \text{ mL})}{(0.0700 \text{ M})} = 39.8571 = \mathbf{39.9 \text{ mL}}$$

- 3.72 Plan: Use the density of the solution to find the mass of 1 L of solution. Volume in liters must be converted to volume in mL. The 70.0% by mass translates to 70.0 g solute/100 g solution and is used to find the mass of  $\text{HNO}_3$  in 1 L of solution. Convert mass of  $\text{HNO}_3$  to moles to obtain moles/L, molarity.

Solution:

$$\text{a) Mass (g) of 1 L of solution} = (1 \text{ L solution}) \left( \frac{1 \text{ mL}}{10^{-3} \text{ L}} \right) \left( \frac{1.41 \text{ g solution}}{1 \text{ mL}} \right) = 1410 \text{ g solution}$$

$$\text{Mass (g) of HNO}_3 \text{ in 1 L of solution} = (1410 \text{ g solution}) \left( \frac{70.0 \text{ g HNO}_3}{100 \text{ g solution}} \right) = \mathbf{987 \text{ g HNO}_3/\text{L}}$$

$$\text{b) Moles of HNO}_3 = (987 \text{ g HNO}_3) \left( \frac{1 \text{ mol HNO}_3}{63.02 \text{ g HNO}_3} \right) = 15.6617 \text{ mol HNO}_3$$

$$\text{Molarity of HNO}_3 = \left( \frac{15.6617 \text{ mol HNO}_3}{1 \text{ L solution}} \right) = 15.6617 = \mathbf{15.7 \text{ M HNO}_3}$$

- 3.73 Plan: Use the molarity of the solution to find the moles of  $\text{H}_2\text{SO}_4$  in 1 mL. Convert moles of  $\text{H}_2\text{SO}_4$  to mass of  $\text{H}_2\text{SO}_4$ , divide that mass by the mass of 1 mL of solution, and multiply by 100 for mass percent. Use the density of the solution to find the mass of 1 mL of solution.

Solution:

$$\text{a) Moles of H}_2\text{SO}_4 \text{ in 1 mL} = \left( \frac{18.3 \text{ mol H}_2\text{SO}_4}{1 \text{ L}} \right) \left( \frac{10^{-3} \text{ L}}{1 \text{ mL}} \right) = \mathbf{1.83 \times 10^{-2} \text{ mol H}_2\text{SO}_4/\text{mL}}$$

$$\text{b) Mass of H}_2\text{SO}_4 \text{ in 1 mL} = (1.83 \times 10^{-2} \text{ mol H}_2\text{SO}_4) \left( \frac{98.09 \text{ g H}_2\text{SO}_4}{1 \text{ mol H}_2\text{SO}_4} \right) = 1.79505 \text{ g H}_2\text{SO}_4$$

$$\text{Mass of 1 mL of solution} = (1 \text{ mL}) \left( \frac{1.84 \text{ g}}{1 \text{ mL}} \right) = 1.84 \text{ g solution}$$

$$\text{Mass percent} = \frac{\text{mass of H}_2\text{SO}_4}{\text{mass of solution}} (100) = \frac{1.79505 \text{ g H}_2\text{SO}_4}{1.84 \text{ g solution}} (100) = 97.5571 = \mathbf{97.6\% \text{ H}_2\text{SO}_4 \text{ by mass}}$$

- 3.74 Plan: Convert the mass of calcium carbonate to moles, and use the mole ratio in the balanced chemical equation to find the moles of hydrochloric acid required to react with these moles of calcium carbonate. Use the molarity of HCl to find the volume that contains this number of moles.

Solution:



Converting from grams of CaCO<sub>3</sub> to moles:

$$\text{Moles of CaCO}_3 = (16.2 \text{ g CaCO}_3) \left( \frac{1 \text{ mol CaCO}_3}{100.09 \text{ g CaCO}_3} \right) = 0.161854 \text{ mol CaCO}_3$$

Converting from moles of CaCO<sub>3</sub> to moles of HCl:

$$\text{Moles of HCl} = (0.161854 \text{ mol CaCO}_3) \left( \frac{2 \text{ mol HCl}}{1 \text{ mol CaCO}_3} \right) = 0.323708 \text{ mol HCl}$$

Converting from moles of HCl to volume:

$$\text{Volume (mL) of HCl} = (0.323708 \text{ mol HCl}) \left( \frac{1 \text{ L}}{0.383 \text{ mol HCl}} \right) \left( \frac{1 \text{ mL}}{10^{-3} \text{ L}} \right) = 845.1906 = \mathbf{845 \text{ mL HCl solution}}$$

- 3.75 Plan: Convert the volume of NaOH solution to liters and multiply by the molarity of the solution to obtain moles of NaOH. Use the mole ratio in the balanced chemical equation to find the moles of NaH<sub>2</sub>PO<sub>4</sub> required to react with these moles of NaOH. Finally, convert moles of NaH<sub>2</sub>PO<sub>4</sub> to moles.

Solution:

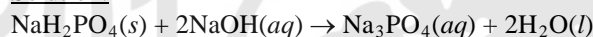

$$\text{Volume (L)} = (43.74 \text{ mL}) \left( \frac{10^{-3} \text{ L}}{1 \text{ mL}} \right) = 0.04374 \text{ mL}$$

Finding moles of NaOH:

$$\text{Moles of NaOH} = (0.04374 \text{ L}) \left( \frac{0.285 \text{ mol NaOH}}{1 \text{ L}} \right) = 0.0124659 \text{ mol NaOH}$$

Converting from moles of NaOH to moles of NaH<sub>2</sub>PO<sub>4</sub>:

$$\text{Moles of NaH}_2\text{PO}_4 = (0.0124659 \text{ mol NaOH}) \left( \frac{1 \text{ mol NaH}_2\text{PO}_4}{2 \text{ mol NaOH}} \right) = 0.00623295 \text{ mol NaH}_2\text{PO}_4$$

Converting from moles of NaH<sub>2</sub>PO<sub>4</sub> to mass:

$$\text{Mass (g) of NaH}_2\text{PO}_4 = (0.00623295 \text{ mol NaH}_2\text{PO}_4) \left( \frac{119.98 \text{ g NaH}_2\text{PO}_4}{1 \text{ mol NaH}_2\text{PO}_4} \right) = 0.747829 = \mathbf{0.748 \text{ g NaH}_2\text{PO}_4}$$

- 3.76 Plan: The first step is to write and balance the chemical equation for the reaction. Multiply the molarity and volume of each of the reactants to determine the moles of each. To determine which reactant is limiting, calculate the amount of barium sulfate formed from each reactant, assuming an excess of the other reactant. The reactant that produces less product is the limiting reagent. Use the limiting reagent and the mole ratio from the balanced chemical equation to determine the mass of barium sulfate formed.

Solution:

The balanced chemical equation is:

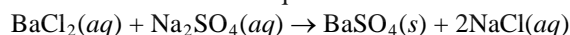



$$\text{Moles of BaCl}_2 = (35.0 \text{ mL}) \left( \frac{10^{-3} \text{ L}}{1 \text{ mL}} \right) \left( \frac{0.160 \text{ mol BaCl}_2}{1 \text{ L}} \right) = 0.00560 \text{ mol BaCl}_2$$

Finding the moles of BaSO<sub>4</sub> from the moles of BaCl<sub>2</sub> (if Na<sub>2</sub>SO<sub>4</sub> is limiting):

$$\text{Moles of BaSO}_4 \text{ from BaCl}_2 = (0.00560 \text{ mol BaCl}_2) \left( \frac{1 \text{ mol BaSO}_4}{1 \text{ mol BaCl}_2} \right) = 0.00560 \text{ mol BaSO}_4$$

$$\text{Moles of Na}_2\text{SO}_4 = (58.0 \text{ mL}) \left( \frac{10^{-3} \text{ L}}{1 \text{ mL}} \right) \left( \frac{0.065 \text{ mol Na}_2\text{SO}_4}{1 \text{ L}} \right) = 0.00377 \text{ mol Na}_2\text{SO}_4$$

Finding the moles of BaSO<sub>4</sub> from the moles of Na<sub>2</sub>SO<sub>4</sub> (if BaCl<sub>2</sub> is limiting):

$$\text{Moles BaSO}_4 \text{ from Na}_2\text{SO}_4 = (0.00377 \text{ mol Na}_2\text{SO}_4) \left( \frac{1 \text{ mol BaSO}_4}{1 \text{ mol Na}_2\text{SO}_4} \right) = 0.00377 \text{ mol BaSO}_4$$

Sodium sulfate is the limiting reactant.

Converting from moles of BaSO<sub>4</sub> to mass:

$$\text{Mass (g) of BaSO}_4 = (0.00377 \text{ mol BaSO}_4) \left( \frac{233.4 \text{ g BaSO}_4}{1 \text{ mol BaSO}_4} \right) = 0.879918 = \mathbf{0.88 \text{ g BaSO}_4}$$

- 3.77 Plan: The first step is to write and balance the chemical equation for the reaction. Use the molarity and volume of each of the reactants to determine the moles of each. To determine which reactant is limiting, calculate the amount of either product formed from each reactant, assuming an excess of the other reactant. The reactant that produces less product is the limiting reagent. Use the limiting reagent and the mole ratio from the balanced chemical equation to determine the amount of the excess reactant that reacts. The difference between the amount of excess reactant that reacts and the initial amount of reactant supplied gives the amount of excess reactant remaining.

Solution:

The balanced chemical equation is:

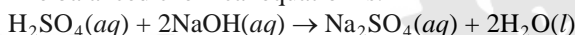

We can use either product to determine the limiting reactant. We will use sodium sulfate.

$$\text{Moles of H}_2\text{SO}_4 = (350.0 \text{ mL}) \left( \frac{10^{-3} \text{ L}}{1 \text{ mL}} \right) \left( \frac{0.210 \text{ mol H}_2\text{SO}_4}{1 \text{ L}} \right) = 0.0735 \text{ mol H}_2\text{SO}_4$$

Finding the moles of Na<sub>2</sub>SO<sub>4</sub> from the moles of H<sub>2</sub>SO<sub>4</sub> (if NaOH is limiting):

$$\text{Moles of Na}_2\text{SO}_4 \text{ from H}_2\text{SO}_4 = (0.0735 \text{ mol H}_2\text{SO}_4) \left( \frac{1 \text{ mol Na}_2\text{SO}_4}{1 \text{ mol H}_2\text{SO}_4} \right) = 0.0735 \text{ mol Na}_2\text{SO}_4$$

$$\text{Moles of NaOH} = (0.500 \text{ L}) \left( \frac{0.196 \text{ mol NaOH}}{1 \text{ L}} \right) = 0.0980 \text{ mol NaOH}$$

Finding the moles of Na<sub>2</sub>SO<sub>4</sub> from the moles of NaOH (if H<sub>2</sub>SO<sub>4</sub> is limiting):

$$\text{Moles of Na}_2\text{SO}_4 \text{ from NaOH} = (0.0980 \text{ mol NaOH}) \left( \frac{1 \text{ mol Na}_2\text{SO}_4}{2 \text{ mol NaOH}} \right) = 0.0490 \text{ mol Na}_2\text{SO}_4$$

NaOH is the limiting reactant and will be used in the remainder of the calculations.

$$\text{Moles of H}_2\text{SO}_4 \text{ that react with NaOH} = (0.0980 \text{ mol NaOH}) \left( \frac{1 \text{ mol H}_2\text{SO}_4}{2 \text{ mol NaOH}} \right) = 0.0490 \text{ mol H}_2\text{SO}_4$$

$$\begin{aligned} \text{Moles of H}_2\text{SO}_4 \text{ remaining} &= \text{initial moles} - \text{moles reacting with NaOH} \\ &= 0.0735 \text{ mol} - 0.0490 \text{ mol} = \mathbf{0.0245 \text{ mol H}_2\text{SO}_4} \end{aligned}$$

- 3.78 Plan: The first part of the problem is a simple dilution problem ( $M_1V_1 = M_2V_2$ ). The volume in units of gallons can be used. In part b), convert mass of HCl to moles and use the molarity to find the volume that contains that number of moles.

Solution:

$$a) M_1 = 11.7 M \quad V_1 = ? \quad M_2 = 3.5 M \quad V_2 = 3.0 \text{ gal}$$

$$V_1 = \frac{M_2 \times V_2}{M_1} = \frac{(3.5 M)(3.0 \text{ gal})}{11.7 M} = 0.897436 \text{ gal}$$

Instructions: Be sure to wear goggles to protect your eyes! Pour approximately 2.0 gal of water into the container. Add slowly and with mixing 0.90 gal of 11.7 M HCl into the water. Dilute to 3.0 gal with water.

b) Converting from mass of HCl to moles of HCl:

$$\text{Moles of HCl} = (9.66 \text{ g HCl}) \left( \frac{1 \text{ mol HCl}}{36.46 \text{ g HCl}} \right) = 0.264948 \text{ mol HCl}$$

Converting from moles of HCl to volume:

$$\begin{aligned} \text{Volume (mL) of solution} &= (0.264948 \text{ mol HCl}) \left( \frac{1 \text{ L}}{11.7 \text{ mol HCl}} \right) \left( \frac{1 \text{ mL}}{10^{-3} \text{ L}} \right) \\ &= 22.64513 = \mathbf{22.6 \text{ mL muriatic acid solution}} \end{aligned}$$

- 3.79 Plan: The moles of narceine and the moles of water are required. We can assume any mass of narceine hydrate (we will use 100 g), and use this mass to determine the moles of hydrate. The moles of water in the hydrate is obtained by taking 10.8% of the 100 g mass of hydrate and converting the mass to moles of water. Divide the moles of water by the moles of hydrate to find the value of x.

Solution:

Assuming a 100 g sample of narceine hydrate:

$$\begin{aligned} \text{Moles of narceine hydrate} &= (100 \text{ g narceine hydrate}) \left( \frac{1 \text{ mol narceine hydrate}}{499.52 \text{ g narceine hydrate}} \right) \\ &= 0.20019 \text{ mol narceine hydrate} \end{aligned}$$

$$\text{Mass (g) of H}_2\text{O} = (100 \text{ g narceine hydrate}) \left( \frac{10.8\% \text{ H}_2\text{O}}{100\% \text{ narceine hydrate}} \right) = 10.8 \text{ g H}_2\text{O}$$

$$\text{Moles of H}_2\text{O} = (10.8 \text{ g H}_2\text{O}) \left( \frac{1 \text{ mol H}_2\text{O}}{18.02 \text{ g H}_2\text{O}} \right) = 0.59933 \text{ mol H}_2\text{O}$$

$$x = \frac{\text{moles of H}_2\text{O}}{\text{moles of hydrate}} = \frac{0.59933 \text{ mol}}{0.20019 \text{ mol}} = \mathbf{3}$$

Thus, there are three water molecules per mole of hydrate. The formula for narceine hydrate is **narceine•3H<sub>2</sub>O**.

- 3.80 Plan: Determine the formula and the molar mass of each compound. The formula gives the relative numbers of moles of each element present. Multiply the number of moles of each element by its molar mass to find the total mass of element in 1 mole of compound. Mass percent =  $\frac{\text{total mass of element}}{\text{molar mass of compound}}(100)$ . List the compounds from the highest %H to the lowest.

Solution:

Name	Chemical formula	Molar mass (g/mol)	Mass percent H = $\frac{\text{moles of H} \times \text{molar mass}}{\text{molar mass of compound}}(100)$
Ethane	C <sub>2</sub> H <sub>6</sub>	30.07	$\frac{6 \text{ mol}(1.008 \text{ g/mol})}{30.07 \text{ g}}(100) = 20.11\% \text{ H}$
Propane	C <sub>3</sub> H <sub>8</sub>	44.09	$\frac{8 \text{ mol}(1.008 \text{ g/mol})}{44.09 \text{ g}}(100) = 18.29\% \text{ H}$
Benzene	C <sub>6</sub> H <sub>6</sub>	78.11	$\frac{6 \text{ mol}(1.008 \text{ g/mol})}{78.11 \text{ g}}(100) = 7.743\% \text{ H}$

Ethanol	$C_2H_5OH$	46.07	$\frac{6 \text{ mol}(1.008 \text{ g/mol})}{46.07 \text{ g}}(100) = 13.13\% \text{ H}$
Cetyl palmitate	$C_{32}H_{64}O_2$	480.83	$\frac{64 \text{ mol}(1.008 \text{ g/mol})}{480.83 \text{ g}}(100) = 13.42\% \text{ H}$

The hydrogen percentage decreases in the following order:

**Ethane > Propane > Cetyl palmitate > Ethanol > Benzene**

- 3.81 Plan: The names must first be converted to chemical formulas. Balancing is a trial-and-error procedure. Balance one element at a time, placing coefficients where needed to have the same number of atoms of a particular element on each side of the equation. The smallest whole-number coefficients should be used. Remember that oxygen, chlorine, and hydrogen are diatomic.

Solution:

a) All of the substances are gases.

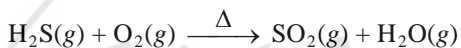

There are 2 O atoms in  $O_2$  on the left and 3 O atoms in  $SO_2$  and  $H_2O$  on the right; place a coefficient of 2 in front of  $H_2O$  on the right and a coefficient of 2 in front of  $O_2$  on the left for a total of 4 oxygen atoms on each side:

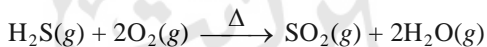

Now the 4 H atoms in  $2H_2O$  on the right require a coefficient of 2 in front of  $H_2S$  on the left:

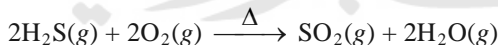

The 2 S atoms in  $2H_2S$  on the left require a coefficient of 2 in front of  $SO_2$  on the right:

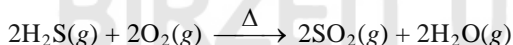

Now the O atoms are no longer balanced; the 6 O atoms on the right (4 in  $2SO_2$  and 2 in  $2H_2O$ ) require a coefficient of 6 in front of  $O_2$  on the left:

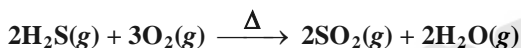

b) All of the substances are solid (crystalline).

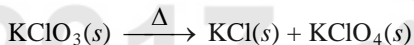

There are 3 O atoms in  $KClO_3$  on the left and 4 O atoms in  $KClO_4$  on the right. Place a coefficient of 4 in front of  $KClO_3$  and a coefficient of 3 in front of  $KClO_4$  for a total of 12 O atoms on each side. The K and Cl atoms are balanced with 4 K atoms and 4 Cl atoms on each side:



c) Hydrogen and water vapor are gases; iron and iron(III) oxide are solids.

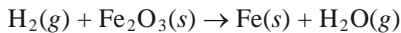

The 2 Fe atoms in  $Fe_2O_3$  on the left require a coefficient of 2 in front of Fe on the right:

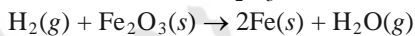

The 3 O atoms in  $Fe_2O_3$  on the left require a coefficient of 3 in front of  $H_2O$  on the right:

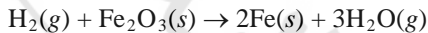

The 6 H atoms in  $3H_2O$  on the right require a coefficient of 3 in front of  $H_2$  on the left:

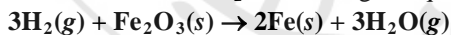

d) All of the substances are gases; combustion required oxygen as a reactant.



The 2 C atoms in  $C_2H_6$  on the left require a coefficient of 2 in front of  $CO_2$  on the right:

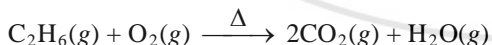

The 6 H atoms in  $C_2H_6$  on the left require a coefficient of 3 in front of  $H_2O$  on the right:

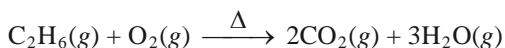

The 7 O atoms on the right (4 in  $2CO_2$  and 3 in  $3H_2O$ ) require a coefficient of  $7/2$  in front of  $O_2$  on the left:

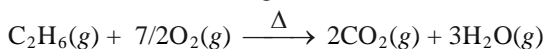

Double all coefficients to get whole number coefficients:

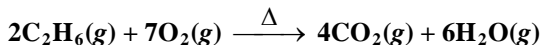

e) Iron(II) chloride and iron(III) fluoride are solids and the other substances are gases.

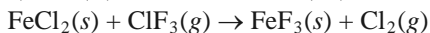

There are 3 Cl atoms on the left (2 in  $\text{FeCl}_2$  and 1 in  $\text{ClF}_3$ ) and 2 Cl atoms in  $\text{Cl}_2$  on the right. Place a coefficient of 2 in front of  $\text{Cl}_2$  and a coefficient of 2 in front of  $\text{ClF}_3$  on the left for a total of 4 Cl atoms on each side:

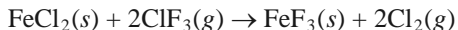

The 6 F atoms in  $2\text{ClF}_3$  require a coefficient of 2 in front of  $\text{FeF}_3$  on the right:

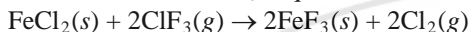

The 2 Fe atoms in  $\text{FeF}_3$  on the right require a coefficient of 2 in front of  $\text{FeCl}_2$  on the left:

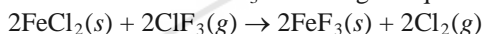

Now the Cl atoms are not balanced with 6 on the left (4 in  $2\text{FeCl}_2$  and 2 in  $2\text{ClF}_3$ ) and 4 in  $2\text{Cl}_2$  on the right;

place

a coefficient of 3 in front of  $\text{Cl}_2$  on the right:

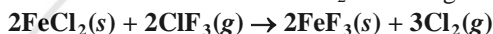

- 3.82 Plan: In combustion analysis, finding the moles of carbon and hydrogen is relatively simple because all of the carbon present in the sample is found in the carbon of  $\text{CO}_2$ , and all of the hydrogen present in the sample is found in the hydrogen of  $\text{H}_2\text{O}$ . Convert the mass of  $\text{CO}_2$  to moles and use the ratio between  $\text{CO}_2$  and C to find the moles and mass of C present. Do the same to find the moles and mass of H from  $\text{H}_2\text{O}$ . Divide the moles of C and H by the smaller value to convert to whole numbers to get the empirical formula.

Solution:

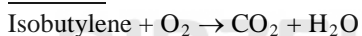

$$\text{Moles of C} = (2.657 \text{ g CO}_2) \left( \frac{1 \text{ mol CO}_2}{44.01 \text{ g CO}_2} \right) \left( \frac{1 \text{ mol C}}{1 \text{ mol CO}_2} \right) = 0.06037 \text{ mol C}$$

$$\text{Moles of H} = (1.089 \text{ g H}_2\text{O}) \left( \frac{1 \text{ mol H}_2\text{O}}{18.02 \text{ g H}_2\text{O}} \right) \left( \frac{2 \text{ mol H}}{1 \text{ mol H}_2\text{O}} \right) = 0.1209 \text{ mol H}$$

$$\text{Preliminary formula} = \text{C}_{0.06037}\text{H}_{0.1209}$$

Converting to integer subscripts (dividing all by the smallest subscript):

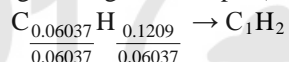

This gives an empirical formula of  $\text{CH}_2$ .

- 3.83 Plan: Write a balanced equation. Use the density of toluene to convert the given volume of toluene to mass and divide by the molar mass of toluene to convert mass to moles. Use the mole ratio between toluene and oxygen to find the moles and then mass of oxygen required for the reaction. The mole ratio between toluene and the gaseous products are used to find the moles of product produced. The moles of water are multiplied by Avogadro's number to find the number of water molecules.

Solution:

The balanced chemical equation is:

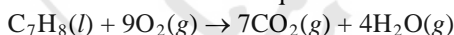

$$\text{a) Moles of C}_7\text{H}_8 = (20.0 \text{ mL C}_7\text{H}_8) \left( \frac{0.867 \text{ g C}_7\text{H}_8}{1 \text{ mL C}_7\text{H}_8} \right) \left( \frac{1 \text{ mol C}_7\text{H}_8}{92.13 \text{ g C}_7\text{H}_8} \right) = 0.1882123 \text{ mol C}_7\text{H}_8$$

$$\text{Mass (g) oxygen} = (0.1882123 \text{ mol C}_7\text{H}_8) \left( \frac{9 \text{ mol O}_2}{1 \text{ mol C}_7\text{H}_8} \right) \left( \frac{32.00 \text{ g O}_2}{1 \text{ mol O}_2} \right) = 54.20514 = \mathbf{54.2 \text{ g O}_2}$$

$$\text{b) Total moles of gas} = (0.1882123 \text{ mol C}_7\text{H}_8) \left( \frac{11 \text{ mol product gas}}{1 \text{ mol C}_7\text{H}_8} \right) = 2.07034 = \mathbf{2.07 \text{ mol of gas}}$$

The 11 mol of gas is an exact, not measured, number, so it does not affect the significant figures.

$$\text{c) Moles of H}_2\text{O} = (0.1882123 \text{ mol C}_7\text{H}_8) \left( \frac{4 \text{ mol H}_2\text{O}}{1 \text{ mol C}_7\text{H}_8} \right) = 0.7528492 \text{ mol H}_2\text{O}$$

$$\begin{aligned} \text{Molecules of H}_2\text{O} &= (0.7528492 \text{ mol H}_2\text{O}) \left( \frac{6.022 \times 10^{23} \text{ H}_2\text{O molecules}}{1 \text{ mol H}_2\text{O}} \right) \\ &= 4.53366 \times 10^{23} = \mathbf{4.53 \times 10^{23} \text{ molecules H}_2\text{O}} \end{aligned}$$

- 3.84 **Plan:** If 100.0 g of dinitrogen tetroxide reacts with 100.0 g of hydrazine ( $\text{N}_2\text{H}_4$ ), what is the theoretical yield of nitrogen if no side reaction takes place? First, we need to identify the limiting reactant. To determine which reactant is limiting, calculate the amount of nitrogen formed from each reactant, assuming an excess of the other reactant. The reactant that produces less product is the limiting reagent. Use the limiting reagent and the mole ratio from the balanced chemical equation to determine the theoretical yield of nitrogen. Then determine the amount of limiting reactant required to produce 10.0 grams of NO. Reduce the amount of limiting reactant by the amount used to produce NO. The reduced amount of limiting reactant is then used to calculate an “actual yield.” The “actual” and theoretical yields will give the maximum percent yield.

**Solution:**

The balanced reaction is  $2\text{N}_2\text{H}_4(l) + \text{N}_2\text{O}_4(l) \rightarrow 3\text{N}_2(g) + 4\text{H}_2\text{O}(g)$

Determining the limiting reactant:

Finding the moles of  $\text{N}_2$  from the amount of  $\text{N}_2\text{O}_4$  (if  $\text{N}_2\text{H}_4$  is limiting):

$$\text{Moles of N}_2 \text{ from N}_2\text{O}_4 = (100.0 \text{ g N}_2\text{O}_4) \left( \frac{1 \text{ mol N}_2\text{O}_4}{92.02 \text{ g N}_2\text{O}_4} \right) \left( \frac{3 \text{ mol N}_2}{1 \text{ mol N}_2\text{O}_4} \right) = 3.26016 \text{ mol N}_2$$

Finding the moles of  $\text{N}_2$  from the amount of  $\text{N}_2\text{H}_4$  (if  $\text{N}_2\text{O}_4$  is limiting):

$$\text{N}_2 \text{ from N}_2\text{H}_4 = (100.0 \text{ g N}_2\text{H}_4) \left( \frac{1 \text{ mol N}_2\text{H}_4}{32.05 \text{ g N}_2\text{H}_4} \right) \left( \frac{3 \text{ mol N}_2}{2 \text{ mol N}_2\text{H}_4} \right) = 4.68019 \text{ mol N}_2$$

$\text{N}_2\text{O}_4$  is the limiting reactant.

$$\text{Theoretical yield of N}_2 = (100.0 \text{ g N}_2\text{O}_4) \left( \frac{1 \text{ mol N}_2\text{O}_4}{92.02 \text{ g N}_2\text{O}_4} \right) \left( \frac{3 \text{ mol N}_2}{1 \text{ mol N}_2\text{O}_4} \right) \left( \frac{28.02 \text{ g N}_2}{1 \text{ mol N}_2} \right) = 91.3497 \text{ g N}_2$$

How much of the limiting reactant is used to produce 10.0 g NO?

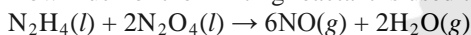

$$\begin{aligned} \text{Mass (g) of N}_2\text{O}_4 \text{ used} &= (10.0 \text{ g NO}) \left( \frac{1 \text{ mol NO}}{30.01 \text{ g NO}} \right) \left( \frac{2 \text{ mol N}_2\text{O}_4}{6 \text{ mol NO}} \right) \left( \frac{92.02 \text{ g N}_2\text{O}_4}{1 \text{ mol N}_2\text{O}_4} \right) \\ &= 10.221 \text{ g N}_2\text{O}_4 \end{aligned}$$

$$\begin{aligned} \text{Amount of N}_2\text{O}_4 \text{ available to produce N}_2 &= 100.0 \text{ g N}_2\text{O}_4 - \text{mass of N}_2\text{O}_4 \text{ required to produce 10.0 g NO} \\ &= 100.0 \text{ g} - 10.221 \text{ g} = 89.779 \text{ g N}_2\text{O}_4 \end{aligned}$$

Determine the “actual yield” of  $\text{N}_2$  from 89.779 g  $\text{N}_2\text{O}_4$ :

$$\begin{aligned} \text{“Actual yield” of N}_2 &= (89.779 \text{ g N}_2\text{O}_4) \left( \frac{1 \text{ mol N}_2\text{O}_4}{92.02 \text{ g N}_2\text{O}_4} \right) \left( \frac{3 \text{ mol N}_2}{1 \text{ mol N}_2\text{O}_4} \right) \left( \frac{28.02 \text{ g N}_2}{1 \text{ mol N}_2} \right) \\ &= 82.01285 \text{ g N}_2 \end{aligned}$$

$$\text{Theoretical yield} = \left( \frac{\text{actual yield}}{\text{theoretical yield}} \right) (100) = \left( \frac{82.01285}{91.3497} \right) (100) = 89.7790 = \mathbf{89.8\%}$$

- 3.85 **Plan:** Identify the product molecules and write the balanced equation. To determine the limiting reactant for part b), examine the product circle to see which reactant remains in excess and which reactant was totally consumed. For part c), use the mole ratios in the balanced equation to determine the number of moles of product formed by each reactant, assuming the other reactant is in excess. The reactant that produces fewer moles of product is the limiting reactant. Use the mole ratio between the two reactants to determine the moles of excess reactant required to react with the limiting reactant. The difference between the initial moles of excess reactant and the moles required for reaction is the moles of excess reactant that remain.

**Solution:**

a) The contents of the circles give:

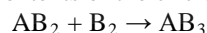

Balancing the reaction gives:

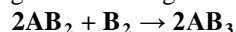

b) Two  $\text{B}_2$  molecules remain after reaction so  $\text{B}_2$  is in excess. All of the  $\text{AB}_2$  molecules have reacted so  $\text{AB}_2$  is the limiting reactant.

c) Finding the moles of  $\text{AB}_3$  from the moles of  $\text{AB}_2$  (if  $\text{B}_2$  is limiting):

$$\text{Moles of } \text{AB}_3 \text{ from } \text{AB}_2 = (5.0 \text{ mol } \text{AB}_2) \left( \frac{2 \text{ mol } \text{AB}_3}{2 \text{ mol } \text{AB}_2} \right) = 5.0 \text{ mol } \text{AB}_3$$

Finding the moles of  $\text{AB}_3$  from the moles of  $\text{B}_2$  (if  $\text{AB}_2$  is limiting):

$$\text{Moles of } \text{AB}_3 \text{ from } \text{B}_2 = (3.0 \text{ mol } \text{B}_2) \left( \frac{2 \text{ mol } \text{AB}_3}{1 \text{ mol } \text{B}_2} \right) = 6.0 \text{ mol } \text{AB}_3$$

$\text{AB}_2$  is the limiting reagent and **5.0 mol of  $\text{AB}_3$**  is formed.

$$\text{d) Moles of } \text{B}_2 \text{ that react with } 5.0 \text{ mol } \text{AB}_2 = (5.0 \text{ mol } \text{AB}_2) \left( \frac{1 \text{ mol } \text{B}_2}{2 \text{ mol } \text{AB}_2} \right) = 2.5 \text{ mol } \text{B}_2$$

The unreacted  $\text{B}_2$  is  $3.0 \text{ mol} - 2.5 \text{ mol} = \mathbf{0.5 \text{ mol } \text{B}_2}$ .

- 3.86 Plan: Since 85% of ions in seawater are from NaCl, take 85% of the mass percent of dissolved ions (4.0%) to find the mass % of NaCl in part a). To find the mass % of  $\text{Na}^+$  and  $\text{Cl}^-$  individually in part b), use the ratio of the mass of the two ions to the mass of NaCl. To find the molarity in part c), use the mass of NaCl in 100 g of seawater; convert mass of NaCl to moles and mass of seawater to volume in liters, using the density. Molarity = moles of NaCl/L of seawater.

Solution:

$$\text{a) } (4.0\% \text{ ions}) \left( \frac{85\% \text{ NaCl}}{100\% \text{ ions}} \right) = \mathbf{3.4\% \text{ NaCl}}$$

$$\text{b) } \% \text{ Na}^+ \text{ ions} = (3.4\% \text{ NaCl}) \left( \frac{22.99 \text{ g Na}^+}{58.44 \text{ g NaCl}} \right) = 1.3375 = \mathbf{1.3\% \text{ Na}^+ \text{ ions}}$$

$$\% \text{ Cl}^- \text{ ions} = (3.4\% \text{ NaCl}) \left( \frac{35.45 \text{ g Cl}^-}{58.44 \text{ g NaCl}} \right) = 2.062 = \mathbf{2.1\% \text{ Cl}^- \text{ ions}}$$

c) Since the mass % of NaCl is 3.4%, there are 3.4 g of NaCl in 100 g of seawater.

$$\text{Moles of NaCl} = (3.4 \text{ g NaCl}) \left( \frac{1 \text{ mol NaCl}}{58.44 \text{ g NaCl}} \right) = 0.0581793 \text{ mol NaCl}$$

$$\text{Volume (L) of 100 g of seawater} = (100 \text{ g seawater}) \left( \frac{1 \text{ mL}}{1.025 \text{ g seawater}} \right) \left( \frac{10^{-3} \text{ L}}{1 \text{ mL}} \right) = 0.097561 \text{ L}$$

$$M \text{ NaCl} = \frac{\text{moles NaCl}}{\text{L seawater}} = \frac{0.0581793 \text{ mol}}{0.097561 \text{ L}} = 0.596338 = \mathbf{0.60 \text{ M NaCl}}$$

- 3.87 a) **False**, a mole of one substance has the same number of units as a mole of any other substance.  
b) **True**  
c) **False**, a limiting-reactant problem is present when the quantity of available material is given for more than one reactant.  
d) **True**

- 3.88 Plan: Count the total number of spheres in each box. The number in box A divided by the volume change in each part will give the number we are looking for and allow us to match boxes.

Solution:

The number in each box is: A = 12, B = 6, C = 4, and D = 3.

- a) When the volume is tripled, there should be  $12/3 = 4$  spheres in a box. This is box **C**.  
b) When the volume is doubled, there should be  $12/2 = 6$  spheres in a box. This is box **B**.  
c) When the volume is quadrupled, there should be  $12/4 = 3$  spheres in a box. This is box **D**.

3.89 **Plan:** To convert mass to moles, divide the mass by the molar mass of the substance. To convert moles to mass, divide by the molar mass. To obtain number of particles, multiply moles by Avogadro's number. Divide a number of particles by Avogadro's number to obtain moles.

**Solution:**

a) Since 1 mole of any substance contains Avogadro's number of entities, equal amounts of moles of various substances contain equal numbers of entities. The number of entities ( $O_3$  molecules) in 0.4 mol of  $O_3$  is **equal** to the number of entities (O atoms) in 0.4 mol of O atoms.

b)  $O_3$  has a molar mass of  $3(16.0 \text{ g/mol O}) = 48.0 \text{ g/mol}$ ; O has a molar mass of  $1(16.0 \text{ g/mol O}) = 16.0 \text{ g/mol}$ . Since  $O_3$  has a larger molar mass than O, **0.4 mol of  $O_3$**  has a greater mass than 0.4 mol of O.

$$\text{c) Moles of } N_2O_4 = (4.0 \text{ g } N_2O_4) \left( \frac{1 \text{ mol } N_2O_4}{92.02 \text{ g } N_2O_4} \right) = 0.043 \text{ mol } N_2O_4$$

$$\text{Moles of } SO_2 = (3.3 \text{ g } SO_2) \left( \frac{1 \text{ mol } SO_2}{64.07 \text{ g } SO_2} \right) = 0.052 \text{ mol } SO_2$$

**$SO_2$**  is the larger quantity in terms of moles.

$$\text{d) Mass (g) of } C_2H_4 = (0.6 \text{ mol } C_2H_4) \left( \frac{28.05 \text{ g } C_2H_4}{1 \text{ mol } C_2H_4} \right) = 17 \text{ g } C_2H_4$$

$$\text{Mass (g) of } F_2 = (0.6 \text{ mol } F_2) \left( \frac{38.00 \text{ g } F_2}{1 \text{ mol } F_2} \right) = 23 \text{ g } F_2$$

**$F_2$**  is the greater quantity in terms of mass.

Note that if each of these values is properly rounded to one significant figure, the answers are identical.

$$\text{e) Total moles of ions in } 2.3 \text{ mol } NaClO_3 = (2.3 \text{ mol } NaClO_3) \left( \frac{2 \text{ mol ions}}{1 \text{ mol } NaClO_3} \right) = 4.6 \text{ mol ions}$$

$$\text{Total moles of ions in } 2.2 \text{ mol } MgCl_2 = (2.2 \text{ mol } MgCl_2) \left( \frac{3 \text{ mol ions}}{1 \text{ mol } MgCl_2} \right) = 6.6 \text{ mol ions}$$

**$MgCl_2$**  is the greater quantity in terms of total moles of ions.

f) The compound with the lower molar mass will have more molecules in a given mass.  $H_2O$  (18.02 g/mol) has a lower molar mass than  $H_2O_2$  (34.02 g/mol). **1.0 g  $H_2O$**  has more molecules than 1.0 g  $H_2O_2$ .

$$\text{g) Moles of } NaBr = (0.500 \text{ L } NaBr) \left( \frac{0.500 \text{ mol}}{1 \text{ L}} \right) = 0.250 \text{ mol } NaBr$$

$$\text{Moles of } Na^+ = (0.250 \text{ mol } NaBr) \left( \frac{1 \text{ mol } Na^+}{1 \text{ mol } NaBr} \right) = 0.250 \text{ mol } Na^+$$

$$\text{Moles of } NaCl = (0.0146 \text{ kg } NaCl) \left( \frac{10^3 \text{ g}}{1 \text{ kg}} \right) \left( \frac{1 \text{ mol } NaCl}{58.44 \text{ g } NaCl} \right) = 0.250 \text{ mol } NaCl$$

$$\text{Moles of } Na^+ = (0.250 \text{ mol } NaCl) \left( \frac{2 \text{ mol ions}}{1 \text{ mol } NaCl} \right) = 0.250 \text{ mol } Na^+$$

The two quantities are **equal**.

h) The heavier atoms,  $^{238}\text{U}$ , will give a greater total mass since there is an equal number of particles of both.

3.90 **Plan:** Write a balanced equation. The coefficients in the balanced equation give the number of molecules or moles of each reactant and product. Moles are converted to amount in grams by multiplying by the molar masses.

**Solution:**

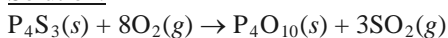

a) 1 molecule of  $P_4S_3$  reacts with 8 molecules of  $O_2$  to produce 1 molecule of  $P_4O_{10}$  and 3 molecules of  $SO_2$ .

b) 1 mol of  $P_4S_3$  reacts with 8 mol of  $O_2$  to produce 1 mol of  $P_4O_{10}$  and 3 mol of  $SO_2$ .

c) 220.09 g of  $P_4S_3$  react with  $8(32.00 \text{ g/mol O}) = 256.00 \text{ g}$  of  $O_2$  to produce 283.88 g of  $P_4O_{10}$  and  $3(64.07 \text{ g/mol } SO_2) = 192.21 \text{ g}$  of  $SO_2$ .

- 3.91 **Plan:** Write a balanced equation. Use the actual yield (105 kg) and the percent yield (98.8%) to find the theoretical yield of hydrogen. Use the mole ratio between hydrogen and water in the balanced equation to obtain the amount of hydrogen required to produce that theoretical yield of water.

**Solution:**

The balanced equation is  $2\text{H}_2(\text{g}) + \text{O}_2(\text{g}) \rightarrow 2\text{H}_2\text{O}(\text{g})$

$$\% \text{ yield} = \left( \frac{\text{actual yield}}{\text{theoretical yield}} \right) \times 100\%$$

$$\text{Theoretical yield (g) of H}_2\text{O} = \frac{\text{actual yield}}{\% \text{ yield}}(100) = \frac{105 \text{ kg}}{98.8\%}(100) = 106.2753 \text{ kg H}_2\text{O}$$

$$\begin{aligned} \text{Mass (g) of H}_2 &= (106.2753 \text{ kg H}_2\text{O}) \left( \frac{10^3 \text{ g}}{1 \text{ kg}} \right) \left( \frac{1 \text{ mol H}_2\text{O}}{18.02 \text{ g H}_2\text{O}} \right) \left( \frac{2 \text{ mol H}_2}{2 \text{ mol H}_2\text{O}} \right) \left( \frac{2.016 \text{ g H}_2}{1 \text{ mol H}_2} \right) \\ &= 1.18896 \times 10^4 = \mathbf{1.19 \times 10^4 \text{ g H}_2} \end{aligned}$$

- 3.92 **Plan:** This problem may be done as two dilution problems with the two final molarities added, or, as done here, it may be done by calculating, then adding the moles and dividing by the total volume.

**Solution:**

$$M \text{ KBr} = \frac{\text{total moles KBr}}{\text{total volume}} = \frac{\text{moles KBr from solution 1} + \text{moles KBr from solution 2}}{\text{volume solution 1} + \text{volume solution 2}}$$

$$M \text{ KBr} = \frac{\left( \frac{0.053 \text{ mol KBr}}{1 \text{ L}} \right) (0.200 \text{ L}) + \left( \frac{0.078 \text{ mol KBr}}{1 \text{ L}} \right) (0.550 \text{ L})}{0.200 \text{ L} + 0.550 \text{ L}} = 0.071333 = \mathbf{0.071 \text{ M KBr}}$$

- 3.93 **Plan:** Divide the given mass of a substance by its molar mass to obtain moles; multiply the given moles of a substance by its molar mass to obtain mass in grams. Number of particles is obtained by multiplying an amount in moles by Avogadro's number. Density is used to convert mass to volume.

**Solution:**

$$\text{a) Moles of NH}_4\text{Br} = (0.588 \text{ g NH}_4\text{Br}) \left( \frac{1 \text{ mol NH}_4\text{Br}}{97.94 \text{ g NH}_4\text{Br}} \right) = 0.0060037 = \mathbf{0.00600 \text{ mol NH}_4\text{Br}}$$

$$\text{b) Moles of KNO}_3 = (88.5 \text{ g KNO}_3) \left( \frac{1 \text{ mol KNO}_3}{101.11 \text{ g KNO}_3} \right) = 0.875284 \text{ mol KNO}_3$$

$$\begin{aligned} \text{Number of K}^+ \text{ ions} &= (0.875284 \text{ mol KNO}_3) \left( \frac{1 \text{ mol K}^+}{1 \text{ mol KNO}_3} \right) \left( \frac{6.022 \times 10^{23} \text{ K}^+ \text{ ions}}{1 \text{ mol K}^+} \right) \\ &= 5.27096 \times 10^{23} = \mathbf{5.27 \times 10^{23} \text{ K}^+ \text{ ions}} \end{aligned}$$

$$\text{c) Mass (g) of C}_3\text{H}_8\text{O}_3 = (5.85 \text{ mol C}_3\text{H}_8\text{O}_3) \left( \frac{92.09 \text{ g C}_3\text{H}_8\text{O}_3}{1 \text{ mol C}_3\text{H}_8\text{O}_3} \right) = 538.7265 = \mathbf{539 \text{ g C}_3\text{H}_8\text{O}_3}$$

$$\text{d) Mass (g) of CHCl}_3 = (2.85 \text{ mol CHCl}_3) \left( \frac{119.37 \text{ g CHCl}_3}{1 \text{ mol CHCl}_3} \right) = 340.2045 \text{ g CHCl}_3$$

$$\text{Volume (mL) of CHCl}_3 = (340.2045 \text{ g CHCl}_3) \left( \frac{\text{mL}}{1.48 \text{ g CHCl}_3} \right) = 229.868 = \mathbf{230. \text{ mL CHCl}_3}$$

$$\text{e) Moles of Na}^+ = (2.11 \text{ mol Na}_2\text{CO}_3) \left( \frac{2 \text{ mol Na}^+}{1 \text{ mol Na}_2\text{CO}_3} \right) = 4.22 \text{ mol Na}^+$$

$$\text{Number of Na}^+ = (4.22 \text{ mol Na}^+) \left( \frac{6.022 \times 10^{23} \text{ Na}^+ \text{ ions}}{1 \text{ mol Na}^+} \right) = 2.54128 \times 10^{24} = \mathbf{2.54 \times 10^{24} \text{ Na}^+ \text{ ions}}$$



$$\text{f) Moles of Cd atoms} = (25.0\mu\text{g Cd}) \left( \frac{10^{-6}\text{ g}}{1\mu\text{g}} \right) \left( \frac{1\text{ mol Cd}}{112.4\text{ g Cd}} \right) = 2.224199 \times 10^{-7}\text{ mol Cd atoms}$$

$$\begin{aligned} \text{Number of Cd atoms} &= (2.224199 \times 10^{-7}\text{ mol Cd}) \left( \frac{6.022 \times 10^{23}\text{ Cd atoms}}{1\text{ mol Cd}} \right) \\ &= 1.3394126 \times 10^{17} = \mathbf{1.34 \times 10^{17}\text{ Cd atoms}} \end{aligned}$$

$$\begin{aligned} \text{g) Number of F atoms} &= (0.0015\text{ mol F}_2) \left( \frac{2\text{ mol F}}{1\text{ mol F}_2} \right) \left( \frac{6.022 \times 10^{23}\text{ F atoms}}{1\text{ mol F}} \right) \\ &= 1.8066 \times 10^{21} = \mathbf{1.8 \times 10^{21}\text{ F atoms}} \end{aligned}$$

3.94 Neither A nor B has any  $\text{XY}_3$  molecules. Both C and D have  $\text{XY}_3$  molecules. D shows both  $\text{XY}_3$  and  $\text{XY}$  molecules. Only C has a single  $\text{XY}_3$  product, thus the answer is **C**.

3.95 Plan: Deal with the methane and propane separately, and combine the results. Balanced equations are needed for each hydrocarbon. The total mass and the percentages will give the mass of each hydrocarbon. The mass of each hydrocarbon is changed to moles, and through the balanced chemical equation the amount of  $\text{CO}_2$  produced by each gas may be found. Summing the amounts of  $\text{CO}_2$  gives the total from the mixture. For part b), let  $x$  and  $252 - x$  represent the masses of  $\text{CH}_4$  and  $\text{C}_3\text{H}_8$ , respectively.

Solution:

a) The balanced chemical equations are:

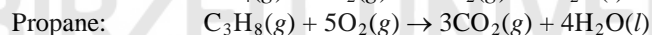
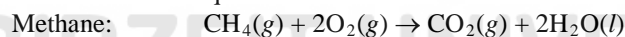

Mass (g) of  $\text{CO}_2$  from each:

$$\text{Methane: } (200.\text{g Mixture}) \left( \frac{25.0\%}{100\%} \right) \left( \frac{1\text{ mol CH}_4}{16.04\text{ g CH}_4} \right) \left( \frac{1\text{ mol CO}_2}{1\text{ mol CH}_4} \right) \left( \frac{44.01\text{ g CO}_2}{1\text{ mol CO}_2} \right) = 137.188\text{ g CO}_2$$

$$\text{Propane: } (200.\text{g Mixture}) \left( \frac{75.0\%}{100\%} \right) \left( \frac{1\text{ mol C}_3\text{H}_8}{44.09\text{ g C}_3\text{H}_8} \right) \left( \frac{3\text{ mol CO}_2}{1\text{ mol C}_3\text{H}_8} \right) \left( \frac{44.01\text{ g CO}_2}{1\text{ mol CO}_2} \right) = 449.183\text{ g CO}_2$$

Total  $\text{CO}_2 = 137.188\text{ g} + 449.183\text{ g} = 586.371 = \mathbf{586\text{ g CO}_2}$

b) Since the mass of  $\text{CH}_4$  + the mass of  $\text{C}_3\text{H}_8 = 252\text{ g}$ , let  $x = \text{mass of CH}_4$  in the mixture and  $252 - x = \text{mass of C}_3\text{H}_8$  in the mixture. Use mole ratios to calculate the amount of  $\text{CO}_2$  formed from  $x$  amount of  $\text{CH}_4$  and the amount of  $\text{CO}_2$  formed from  $252 - x$  amount of  $\text{C}_3\text{H}_8$ .

The total mass of  $\text{CO}_2$  produced = 748 g.

$$\text{The total moles of CO}_2 \text{ produced} = (748\text{ g CO}_2) \left( \frac{1\text{ mol CO}_2}{44.01\text{ g CO}_2} \right) = 16.996\text{ mol CO}_2$$

16.996 mol  $\text{CO}_2 =$

$$(x\text{ g CH}_4) \left( \frac{1\text{ mol CH}_4}{16.04\text{ g CH}_4} \right) \left( \frac{1\text{ mol CO}_2}{1\text{ mol CH}_4} \right) + (252 - x\text{ g C}_3\text{H}_8) \left( \frac{1\text{ mol C}_3\text{H}_8}{44.09\text{ g C}_3\text{H}_8} \right) \left( \frac{3\text{ mol CO}_2}{1\text{ mol C}_3\text{H}_8} \right)$$

$$16.996\text{ mol CO}_2 = \frac{x}{16.04}\text{ mol CO}_2 + \frac{3(252 - x)}{44.09}\text{ mol CO}_2$$

$$16.996\text{ mol CO}_2 = \frac{x}{16.04}\text{ mol CO}_2 + \frac{756 - 3x}{44.09}\text{ mol CO}_2$$

$$16.996\text{ mol CO}_2 = 0.06234x\text{ mol CO}_2 + (17.147 - 0.06804x)\text{ mol CO}_2$$

$$16.996 = 17.147 - 0.0057x$$

$$x = 26.49\text{ g CH}_4 \quad 252 - x = 252\text{ g} - 26.49\text{ g} = 225.51\text{ g C}_3\text{H}_8$$

$$\text{Mass \% CH}_4 = \frac{\text{mass of CH}_4}{\text{mass of mixture}} (100) = \frac{26.49\text{ g CH}_4}{252\text{ g mixture}} (100) = \mathbf{10.5\% \text{ CH}_4}$$

$$\text{Mass \% C}_3\text{H}_8 = \frac{\text{mass of C}_3\text{H}_8}{\text{mass of mixture}}(100) = \frac{225.51 \text{ g C}_3\text{H}_8}{252 \text{ g mixture}}(100) = \mathbf{89.5\% \text{ C}_3\text{H}_8}$$

- 3.96 Plan: If we assume a 100-gram sample of fertilizer, then the 30:10:10 percentages become the masses, in grams, of N, P<sub>2</sub>O<sub>5</sub>, and K<sub>2</sub>O. These masses may be changed to moles of substance, and then to moles of each element. To get the desired x:y:1.0 ratio, divide the moles of each element by the moles of potassium.

Solution:

A 100-gram sample of 30:10:10 fertilizer contains 30 g N, 10 g P<sub>2</sub>O<sub>5</sub>, and 10 g K<sub>2</sub>O.

$$\text{Moles of N} = (30 \text{ g N}) \left( \frac{1 \text{ mol N}}{14.01 \text{ g N}} \right) = 2.1413 \text{ mol N}$$

$$\text{Moles of P} = (10 \text{ g P}_2\text{O}_5) \left( \frac{1 \text{ mol P}_2\text{O}_5}{141.94 \text{ g P}_2\text{O}_5} \right) \left( \frac{2 \text{ mol P}}{1 \text{ mol P}_2\text{O}_5} \right) = 0.14090 \text{ mol P}$$

$$\text{Moles of K} = (10 \text{ g K}_2\text{O}) \left( \frac{1 \text{ mol K}_2\text{O}}{94.20 \text{ g K}_2\text{O}} \right) \left( \frac{2 \text{ mol K}}{1 \text{ mol K}_2\text{O}} \right) = 0.21231 \text{ mol K}$$

This gives a N:P:K ratio of 2.1413:0.14090:0.21231

The ratio must be divided by the moles of K and rounded.

$$\frac{2.1413 \text{ mol N}}{0.21231} = 10.086 \quad \frac{0.14090 \text{ mol P}}{0.21231} = 0.66365 \quad \frac{0.21231 \text{ mol K}}{0.21231} = 1$$

$$10.086:0.66365:1.000 \quad \text{or} \quad \mathbf{10:0.66:1.0}$$

- 3.97 Plan: If we assume a 100-gram sample of fertilizer, then the 10:10:10 percentages become the masses, in grams, of N, P<sub>2</sub>O<sub>5</sub>, and K<sub>2</sub>O. These masses may be changed to moles of substance, and then to moles of each element. Use the mole ratio between N and ammonium sulfate, P and ammonium hydrogen phosphate, and K and potassium chloride to find the mass of each compound required to provide the needed amount of the respective element. Divide the mass of each compound by the total mass of sample, 100 g, and multiply by 100 for mass %.

Solution:

Assume a 100 g sample. 10:10:10 indicates 10 g N, 10 g P<sub>2</sub>O<sub>5</sub> and 10 g K<sub>2</sub>O.

$$\text{Moles of N} = (10 \text{ g N}) \left( \frac{1 \text{ mol N}}{14.01 \text{ g N}} \right) = 0.713776 \text{ mol N}$$

$$\text{Moles of P} = (10 \text{ g P}_2\text{O}_5) \left( \frac{1 \text{ mol P}_2\text{O}_5}{141.94 \text{ g P}_2\text{O}_5} \right) \left( \frac{2 \text{ mol P}}{1 \text{ mol P}_2\text{O}_5} \right) = 0.14090 \text{ mol P}$$

$$\text{Moles of K} = (10 \text{ g K}_2\text{O}) \left( \frac{1 \text{ mol K}_2\text{O}}{94.20 \text{ g K}_2\text{O}} \right) \left( \frac{2 \text{ mol K}}{1 \text{ mol K}_2\text{O}} \right) = 0.21231 \text{ mol K}$$

To obtain 0.713776 mol N from (NH<sub>4</sub>)<sub>2</sub>SO<sub>4</sub>:

$$(0.713776 \text{ mol N}) \left( \frac{1 \text{ mol (NH}_4)_2\text{SO}_4}{2 \text{ mol N}} \right) \left( \frac{132.15 \text{ g (NH}_4)_2\text{SO}_4}{1 \text{ mol (NH}_4)_2\text{SO}_4} \right) = 47.1627 \text{ g (NH}_4)_2\text{SO}_4$$

$$\text{Mass \% (NH}_4)_2\text{SO}_4 = \frac{\text{mass of (NH}_4)_2\text{SO}_4}{\text{mass of mixture}}(100) = \frac{47.1627 \text{ g (NH}_4)_2\text{SO}_4}{100 \text{ g mixture}}(100)$$

$$= 47.1627\% = \mathbf{47.2\% \text{ (NH}_4)_2\text{SO}_4}$$

To obtain 0.14090 mol P from (NH<sub>4</sub>)<sub>2</sub>HPO<sub>4</sub>:

$$(0.14090 \text{ mol P}) \left( \frac{1 \text{ mol (NH}_4)_2\text{HPO}_4}{1 \text{ mol P}} \right) \left( \frac{132.06 \text{ g (NH}_4)_2\text{HPO}_4}{1 \text{ mol (NH}_4)_2\text{HPO}_4} \right) = 18.6073 \text{ g (NH}_4)_2\text{HPO}_4$$

$$\text{Mass \% (NH}_4)_2\text{HPO}_4 = \frac{\text{mass of (NH}_4)_2\text{HPO}_4}{\text{mass of mixture}}(100) = \frac{18.6073 \text{ g (NH}_4)_2\text{HPO}_4}{100 \text{ g mixture}}(100)$$

$$= 18.6073\% = \mathbf{18.6\% \text{ (NH}_4)_2\text{HPO}_4}$$

To obtain 0.21231 mol K from KCl:

$$(0.21231 \text{ mol K}) \left( \frac{1 \text{ mol KCl}}{1 \text{ mol K}} \right) \left( \frac{74.55 \text{ g KCl}}{1 \text{ mol KCl}} \right) = 15.8277 \text{ g KCl}$$

$$\text{Mass \% KCl} = \frac{\text{mass of KCl}}{\text{mass of mixture}} (100) = \frac{15.8277 \text{ g KCl}}{100 \text{ g mixture}} (100) = 15.8277\% = \mathbf{15.8\% \text{ KCl}}$$

- 3.98 Plan: Write a balanced equation. Convert the mass of strontium sulfate produced to moles and use the mole ratio in the balanced equation to find the moles of strontium halide required to produce that amount of product. Divide the given mass of strontium halide by the moles of strontium halide to obtain its molar mass. Subtracting the molar mass of strontium from the molar mass of compound gives the molar mass of the halogen in the formula. The molar mass of the halogen is used to identify the halogen.

Solution:

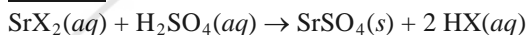

$$0.652 \text{ g} \qquad \qquad \qquad 0.755 \text{ g}$$

$$\text{Moles SrX}_2 = (0.755 \text{ g SrSO}_4) \left( \frac{1 \text{ mol SrSO}_4}{183.69 \text{ g SrSO}_4} \right) \left( \frac{1 \text{ mol SrX}_2}{1 \text{ mol SrSO}_4} \right) = 0.004110186 \text{ mol SrX}_2$$

The 0.652 g sample of  $\text{SrX}_2 = 0.004110186 \text{ mol}$

$$\text{SrX}_2 = \frac{0.652 \text{ g}}{0.004110186 \text{ mol}} = 158.630 \text{ g/mol} = \text{molar mass}$$

Molar mass of  $\text{X}_2 = 158.630 \text{ g} - \text{molar mass of Sr}$

Molar mass of  $\text{X}_2 = 158.630 \text{ g} - 87.62 \text{ g} = 71.01 \text{ g} = \text{X}_2$

Molar mass of  $\text{X} = 71.01 \text{ g}/2 = 35.505 = 35.5 \text{ g/mol} = \text{Cl}$  The original halide formula is  **$\text{SrCl}_2$** .

- 3.99 Plan: Assume 100 grams of mixture. This means the mass of each compound, in grams, is the same as its percentage. Find the mass of C from CO and from  $\text{CO}_2$  and add these masses together. For mass %, divide the total mass of C by the mass of the mixture (100 g) and multiply by 100.

Solution:

100 g of mixture = 35 g CO and 65 g  $\text{CO}_2$ .

$$\text{Mass (g) of C from CO} = (35.0 \text{ g CO}) \left( \frac{1 \text{ mol CO}}{28.01 \text{ g CO}} \right) \left( \frac{1 \text{ mol C}}{1 \text{ mol CO}} \right) \left( \frac{12.01 \text{ g C}}{1 \text{ mol C}} \right) = 15.007 \text{ g C}$$

$$\text{Mass (g) of C from CO}_2 = (65.0 \text{ g CO}_2) \left( \frac{1 \text{ mol CO}_2}{44.01 \text{ g CO}_2} \right) \left( \frac{1 \text{ mol C}}{1 \text{ mol CO}_2} \right) \left( \frac{12.01 \text{ g C}}{1 \text{ mol C}} \right) = 17.738 \text{ g C}$$

Total mass (g) of C = 15.007 g + 17.738 g = 32.745 g C

$$\text{Mass \% C} = \frac{\text{mass of C}}{\text{mass of mixture}} (100) = \frac{32.745 \text{ g C}}{100 \text{ g mixture}} (100) = 32.745 = \mathbf{32.7\% \text{ C}}$$

- 3.100 Plan: Write a balanced equation for the reaction. Count the molecules of each reactant to obtain the moles of each reactant present. Use the mole ratios in the equation to calculate the amount of product formed. Only 87.0% of the calculated amount of product actually forms, so the actual yield is 87.0% of the theoretical yield.

Solution:

The balanced equation is  $\text{SiH}_4 + \text{N}_2\text{F}_4 \rightarrow \text{SiF}_4 + \text{N}_2 + 2\text{H}_2$ .

$$\text{Moles of SiH}_4 = (3 \text{ SiH}_4 \text{ molecules}) \left( \frac{1.25 \times 10^{-2} \text{ mol}}{1 \text{ molecule}} \right) = 0.0375 \text{ mol SiH}_4$$

$$\text{Moles of N}_2\text{F}_4 = (3 \text{ N}_2\text{F}_4 \text{ molecules}) \left( \frac{1.25 \times 10^{-2} \text{ mol}}{1 \text{ molecule}} \right) = 0.0375 \text{ mol N}_2\text{F}_4$$

Since there is an equal amount of each reactant and the ratio between each reactant and  $\text{SiF}_4$  is 1:1, neither reactant is in excess and either may be used to calculate the amount of  $\text{SiF}_4$  produced.

$$\text{Mass (g) of SiF}_4 = (0.0375 \text{ mol SiH}_4) \left( \frac{1 \text{ mol SiF}_4}{1 \text{ mol SiH}_4} \right) \left( \frac{104.09 \text{ g SiF}_4}{1 \text{ mol SiF}_4} \right) = 3.903375 \text{ g SiF}_4$$

$$\% \text{ yield} = \left( \frac{\text{actual Yield}}{\text{theoretical Yield}} \right) \times 100\%$$

$$\text{Actual yield (g) of SiF}_4 = \frac{\% \text{ yield}}{100\%} (\text{theoretical yield}) = \frac{87\%}{100\%} (3.903375 \text{ g SiF}_4) = 3.3959 = \mathbf{3.4 \text{ g SiF}_4}$$

- 3.101 Plan: In combustion analysis, finding the moles of carbon and hydrogen is relatively simple because all of the carbon present in the sample is found in the carbon of  $\text{CO}_2$ , and all of the hydrogen present in the sample is found in the hydrogen of  $\text{H}_2\text{O}$ . Convert the mass of  $\text{CO}_2$  to moles and use the ratio between  $\text{CO}_2$  and C to find the moles and mass of C present. Do the same to find the moles and mass of H from  $\text{H}_2\text{O}$ . Subtracting the masses of C and H from the mass of the sample gives the mass of Fe. Convert the mass of Fe to moles of Fe. Take the moles of C, H, and Fe and divide by the smallest value to convert to whole numbers to get the empirical formula.

Solution:

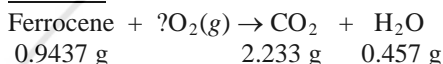

$$\text{Moles of C} = (2.233 \text{ g CO}_2) \left( \frac{1 \text{ mol CO}_2}{44.01 \text{ g CO}_2} \right) \left( \frac{1 \text{ mol C}}{1 \text{ mol CO}_2} \right) = 0.050738 \text{ mol C}$$

$$\text{Mass (g) of C} = (0.050738 \text{ mol C}) \left( \frac{12.01 \text{ g C}}{1 \text{ mol C}} \right) = 0.60936 \text{ g C}$$

$$\text{Moles of H} = (0.457 \text{ g H}_2\text{O}) \left( \frac{1 \text{ mol H}_2\text{O}}{18.02 \text{ g H}_2\text{O}} \right) \left( \frac{2 \text{ mol H}}{1 \text{ mol H}_2\text{O}} \right) = 0.050721 \text{ mol H}$$

$$\text{Mass (g) of H} = (0.050721 \text{ mol H}) \left( \frac{1.008 \text{ g H}}{1 \text{ mol H}} \right) = 0.051127 \text{ g H}$$

$$\text{Mass (g) of Fe} = \text{Sample mass} - (\text{mass of C} + \text{mass of H})$$

$$= 0.9437 \text{ g} - (0.60936 \text{ g C} + 0.052217 \text{ g H}) = 0.283213 \text{ g Fe}$$

$$\text{Moles of Fe} = (0.283213 \text{ g Fe}) \left( \frac{1 \text{ mol Fe}}{55.85 \text{ g Fe}} \right) = 0.005071 \text{ mol Fe}$$

$$\text{Preliminary formula} = \text{C}_{0.050738} \text{H}_{0.050721} \text{Fe}_{0.005071}$$

Converting to integer subscripts (dividing all by the smallest subscript):

$$\frac{\text{C}_{0.050738}}{0.005071} \frac{\text{H}_{0.050721}}{0.005071} \frac{\text{Fe}_{0.005071}}{0.005071} \rightarrow \text{C}_{10} \text{H}_{10} \text{Fe}_1$$

**Empirical formula =  $\text{C}_{10}\text{H}_{10}\text{Fe}$**

- 3.102 Plan: Determine the molecular formula from the figure. Once the molecular formula is known, use the periodic table to determine the molar mass. Convert the volume of lemon juice in part b) from qt to mL and use the density to convert from mL to mass in g. Take 6.82% of that mass to find the mass of citric acid and use the molar mass to convert to moles.

Solution:

a) The formula of citric acid obtained by counting the number of carbon atoms, oxygen atoms, and hydrogen atoms is  **$\text{C}_6\text{H}_8\text{O}_7$** .

$$\text{Molar mass} = (6 \times 12.01 \text{ g/mol C}) + (8 \times 1.008 \text{ g/mol H}) + (7 \times 16.00 \text{ g/mol O}) = \mathbf{192.12 \text{ g/mol}}$$

b) Converting volume of lemon juice in qt to mL:

$$\text{Volume (mL) of lemon juice} = (1.50 \text{ qt}) \left( \frac{1 \text{ L}}{1.057 \text{ qt}} \right) \left( \frac{1 \text{ mL}}{10^{-3} \text{ L}} \right) = 1419.111 \text{ mL}$$

Converting volume to mass in grams:

$$\text{Mass (g) of lemon juice} = (1419.111 \text{ mL}) \left( \frac{1.09 \text{ g}}{\text{mL}} \right) = 1546.831 \text{ g lemon juice}$$

$$\text{Mass (g) of C}_6\text{H}_8\text{O}_7 = (1546.831 \text{ g lemon juice}) \left( \frac{6.82\% \text{ C}_6\text{H}_8\text{O}_7}{100\% \text{ lemon juice}} \right) = 105.494 \text{ g C}_6\text{H}_8\text{O}_7$$

$$\text{Moles of C}_6\text{H}_8\text{O}_7 = (105.494 \text{ g C}_6\text{H}_8\text{O}_7) \left( \frac{1 \text{ mol C}_6\text{H}_8\text{O}_7}{192.12 \text{ g C}_6\text{H}_8\text{O}_7} \right) = 0.549104 = \mathbf{0.549 \text{ mol C}_6\text{H}_8\text{O}_7}$$

3.103 Plan: For parts a) and b), convert the masses to moles. Take the moles and divide by the smallest value to convert to whole numbers to get the empirical formula. For part c), write the two balanced equations and use two equations as shown.

Solution:

$$\text{a) Moles of Pt} = (0.327 \text{ g Pt}) \left( \frac{1 \text{ mol Pt}}{195.1 \text{ g Pt}} \right) = 0.001676 \text{ mol Pt}$$

$$\text{Mass (g) of F} = \text{mass of product} - \text{mass of Pt} = 0.519 \text{ g} - 0.327 \text{ g} = 0.192 \text{ g F}$$

$$\text{Moles of F} = (0.192 \text{ g F}) \left( \frac{1 \text{ mol F}}{19.00 \text{ g F}} \right) = 0.010105 \text{ mol F}$$

$$\text{Preliminary formula} = \text{Pt}_{0.001676}\text{F}_{0.010105}$$

Converting to integer subscripts (dividing all by the smallest subscript):

$$\frac{\text{Pt}_{0.001676}\text{F}_{0.010105}}{0.001676} \rightarrow \text{Pt}_1\text{F}_6$$

$$\text{Empirical formula} = \mathbf{PtF_6}$$

$$\text{b) Moles of PtF}_6 = (0.265 \text{ g PtF}_6) \left( \frac{1 \text{ mol PtF}_6}{309.1 \text{ g PtF}_6} \right) = 0.0008576 \text{ mol PtF}_6$$

$$\text{Mass of Xe} = \text{mass of product} - \text{mass of PtF}_6 = 0.378 \text{ g} - 0.265 \text{ g} = 0.113 \text{ g Xe}$$

$$\text{Moles of Xe} = (0.113 \text{ g Xe}) \left( \frac{1 \text{ mol Xe}}{131.3 \text{ g Xe}} \right) = 0.0008606 \text{ mol Xe}$$

$$\text{Preliminary formula} = \text{Xe}_{0.0008606}(\text{PtF}_6)_{0.0008576}$$

Converting to integer subscripts (dividing all by the smallest subscript):

$$\frac{\text{Xe}_{0.0008606}(\text{PtF}_6)_{0.0008576}}{0.0008576} \rightarrow \text{Xe}_1(\text{PtF}_6)_1$$

$$\text{Empirical formula} = \mathbf{XePtF_6}$$

c) This problem can be solved as a system of two equations and two unknowns.

The two equations are:

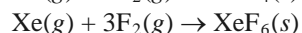
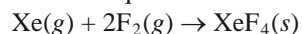

$$\text{Moles of Xe consumed} = 1.85 \times 10^{-4} \text{ mol present} - 9.00 \times 10^{-6} \text{ mol excess} = 1.76 \times 10^{-4} \text{ mol Xe}$$

$$\text{Then } x + y = 1.76 \times 10^{-4} \text{ mol Xe consumed}$$

$$2x + 3y = 5.00 \times 10^{-4} \text{ mol F}_2 \text{ consumed}$$

Solve for x using the first equation and substitute the value of x into the second equation:

$$x = 1.76 \times 10^{-4} - y$$

$$2(1.76 \times 10^{-4} - y) + 3y = 5.00 \times 10^{-4}$$

$$(3.52 \times 10^{-4}) - 2y + 3y = 5.00 \times 10^{-4}$$

$$y = (5.00 \times 10^{-4}) - (3.52 \times 10^{-4}) = 1.48 \times 10^{-4} \text{ mol XeF}_6$$

$$x = (1.76 \times 10^{-4}) - (1.48 \times 10^{-4}) = 2.8 \times 10^{-5} \text{ mol XeF}_4$$

Converting moles of each product to grams using the molar masses:

$$\text{Mass (g) of XeF}_4 = (2.8 \times 10^{-5} \text{ mol XeF}_4) \left( \frac{207.3 \text{ g XeF}_4}{1 \text{ mol XeF}_4} \right) = 5.8044 \times 10^{-3} \text{ g XeF}_4$$

$$\text{Mass (g) of XeF}_6 = (1.48 \times 10^{-4} \text{ mol XeF}_6) \left( \frac{245.3 \text{ g XeF}_6}{1 \text{ mol XeF}_6} \right) = 3.63044 \times 10^{-2} \text{ g XeF}_6$$

Calculate the percent of each compound using the total weight of the products:

$$(5.8044 \times 10^{-3} + 3.63044 \times 10^{-2}) \text{ g} = 0.0421088 \text{ g}$$

$$\text{Mass \% XeF}_4 = \frac{\text{mass of XeF}_4}{\text{total mass}}(100) = \frac{5.8044 \times 10^{-3} \text{ g XeF}_4}{0.0421088 \text{ g}}(100) = 13.784 = \mathbf{14\% XeF}_4$$

$$\text{Mass \% XeF}_6 = \frac{\text{mass of XeF}_6}{\text{total mass}}(100) = \frac{3.63044 \times 10^{-2} \text{ g XeF}_6}{0.0421088 \text{ g}}(100) = 86.2157 = \mathbf{86.2\% XeF}_6$$

- 3.104 Plan: Use the mass percent to find the mass of heme in the sample; use the molar mass to convert the mass of heme to moles. Then find the mass of Fe in the sample by using the mole ratio between heme and iron. The mass of hemin is found by using the mole ratio between heme and hemoglobin.

Solution:

$$\text{a) Mass (g) of heme} = (0.65 \text{ g hemoglobin}) \left( \frac{6.0\% \text{ heme}}{100\% \text{ hemoglobin}} \right) = \mathbf{0.039 \text{ g heme}}$$

$$\text{b) Moles of heme} = (0.039 \text{ g heme}) \left( \frac{1 \text{ mol heme}}{616.49 \text{ g heme}} \right) = 6.32614 \times 10^{-5} = \mathbf{6.3 \times 10^{-5} \text{ mol heme}}$$

$$\text{c) Mass (g) of Fe} = (6.32614 \times 10^{-5} \text{ mol heme}) \left( \frac{1 \text{ mol Fe}}{1 \text{ mol heme}} \right) \left( \frac{55.85 \text{ g Fe}}{1 \text{ mol Fe}} \right) \\ = 3.5331 \times 10^{-3} = \mathbf{3.5 \times 10^{-3} \text{ g Fe}}$$

$$\text{d) Mass (g) of hemin} = (6.32614 \times 10^{-5} \text{ mol heme}) \left( \frac{1 \text{ mol hemin}}{1 \text{ mol heme}} \right) \left( \frac{651.94 \text{ g hemin}}{1 \text{ mol hemin}} \right) \\ = 4.1243 \times 10^{-2} = \mathbf{4.1 \times 10^{-2} \text{ g hemin}}$$

- 3.105 Plan: Find the Mn:O ratio in the two oxides. Write two equations to solve simultaneously; one equation shows that the sum of the ratio of Mn in the two oxides will equal the ratio of Mn in the sample and the other equation shows that the total amount of oxide in the sample is the sum of the amounts of the two oxides. The two equations will give the mole ratio of the two oxides. Convert moles of each oxide to mass to obtain the mass ratio of the two oxides from which the mass % of each can be calculated. Use that mass % of each to find the mass of each in the sample. For part b), the moles of  $\text{Mn}^{3+}$  come from the  $\text{Mn}_2\text{O}_3$  and the moles of  $\text{Mn}^{2+}$  come from the  $\text{MnO}$ .

Solution:

Mn:O ratio:

In sample:	1.00:1.42	or	0.704
In braunite:	2.00:3.00	or	0.667
In manganosite:	1.00:1.00	or	1.00

- a) The total amount of ore is equal to the amount of braunite (B) + the amount of manganosite (M).

$$B + M = 1.00$$

$$M = 1.00 - B$$

The amount of Mn is dependent on the sample's composition.

$$M(1.00) + B(0.667) = 0.704$$

$$(1.00 - B)(1.00) + B(0.667) = 0.704$$

$$1.00 - 1.00B + 0.667B = 0.704$$

$$0.296 = 0.333B$$

$$B = 0.888889 \text{ mol braunite}$$

$$M = 1.00 - B = 1.00 - 0.888889 = 0.111111 \text{ mol manganosite}$$

$$\text{Mass (g) of braunite} = (0.888889 \text{ mol}) \left( \frac{157.88 \text{ g}}{1 \text{ mol}} \right) = 140.338 \text{ g braunite}$$

$$\text{Mass (g) of manganosite} = (0.111111 \text{ mol}) \left( \frac{70.94 \text{ g}}{1 \text{ mol}} \right) = 7.88221 \text{ g manganosite}$$

There are 140.338 g of braunite for every 7.88221 g of manganosite. Finding mass % of each:

$$\text{Mass \% braunite} = \frac{\text{mass of braunite}}{\text{mass of braunite} + \text{manganosite}}(100) = \frac{140.338 \text{ g}}{140.338 + 7.88221 \text{ g}}(100) = 94.6821\%$$

$$\begin{aligned}\text{Mass \% manganosite} &= \frac{\text{mass of manganosite}}{\text{mass of braunite} + \text{manganosite}}(100) = \frac{7.88221 \text{ g}}{140.338 + 7.88221 \text{ g}}(100) \\ &= 5.3179\%\end{aligned}$$

In the 542.3 g sample:

$$\text{Mass (g) of braunite} = (542.3 \text{ g sample}) \left( \frac{94.6821 \text{ braunite}}{100\% \text{ sample}} \right) = 513.461 = \mathbf{513 \text{ g braunite}}$$

$$\text{Mass (g) of manganosite} = (542.3 \text{ g sample}) \left( \frac{5.3179\% \text{ manganosite}}{100\% \text{ sample}} \right) = 28.839 = \mathbf{28.8 \text{ g manganosite}}$$

b) Each mole of braunite,  $\text{Mn}_2\text{O}_3$ , contains 2 moles of  $\text{Mn}^{3+}$  while each mole of manganosite,  $\text{MnO}$ , contains 1 mole of  $\text{Mn}^{2+}$ .

$$\text{Moles of Mn}^{3+} = 2(0.888889 \text{ mol braunite}) = 1.777778 \text{ mol Mn}^{3+}$$

$$\text{Moles of Mn}^{2+} = 1(0.111111 \text{ mol manganosite}) = 0.111111 \text{ mol Mn}^{2+}$$

$$\text{Mn}^{3+}:\text{Mn}^{2+} = \frac{1.777778 \text{ mol Mn}^{3+}}{0.111111 \text{ mol Mn}^{2+}} = 16.000 = \mathbf{16.0}$$

- 3.106 Plan: First, balance the chemical equation. To determine which reactant is limiting, calculate the amount of hydroxyapatite formed from each reactant, assuming an excess of the other reactant. The reactant that produces less product is the limiting reagent. Use the limiting reagent and the mole ratio from the balanced chemical equation to determine the amount of hydroxyapatite formed.

Solution:

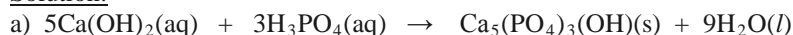

b) Find the limiting reagent.

$$\begin{aligned}\text{Moles of Ca}_5(\text{PO}_4)_3(\text{OH}) \text{ from Ca(OH)}_2 &= (100. \text{ g Ca(OH)}_2) \left( \frac{1 \text{ mol Ca(OH)}_2}{74.10 \text{ g Ca(OH)}_2} \right) \left( \frac{1 \text{ mol Ca}_5(\text{PO}_4)_3(\text{OH})}{5 \text{ mol Ca(OH)}_2} \right) \\ &= 0.2699055 \text{ mol Ca}_5(\text{PO}_4)_3(\text{OH})\end{aligned}$$

Moles of  $\text{Ca}_5(\text{PO}_4)_3(\text{OH})$  from  $\text{H}_3\text{PO}_4$  =

$$\begin{aligned}(100. \text{ g H}_3\text{PO}_4 \text{ solution}) \left( \frac{85 \text{ g H}_3\text{PO}_4}{100. \text{ g H}_3\text{PO}_4 \text{ solution}} \right) \left( \frac{1 \text{ mol H}_3\text{PO}_4}{97.99 \text{ g H}_3\text{PO}_4} \right) \left( \frac{1 \text{ mol Ca}_5(\text{PO}_4)_3(\text{OH})}{3 \text{ mol H}_3\text{PO}_4} \right) \\ = 0.2891452 \text{ mol Ca}_5(\text{PO}_4)_3(\text{OH})\end{aligned}$$

$\text{Ca(OH)}_2$  is the limiting reactant, and will be used to calculate the yield.

$$\begin{aligned}(100. \text{ g Ca(OH)}_2) \left( \frac{1 \text{ mol Ca(OH)}_2}{74.10 \text{ g Ca(OH)}_2} \right) \left( \frac{1 \text{ mol Ca}_5(\text{PO}_4)_3(\text{OH})}{5 \text{ mol Ca(OH)}_2} \right) \left( \frac{502.32 \text{ g Ca}_5(\text{PO}_4)_3(\text{OH})}{1 \text{ mol Ca}_5(\text{PO}_4)_3(\text{OH})} \right) \\ = 135.57893 = \mathbf{140 \text{ g Ca}_5(\text{PO}_4)_3(\text{OH})}\end{aligned}$$

- 3.107 Plan: To determine which reactant is limiting, calculate the amount of aspirin formed from each reactant, assuming an excess of the other reactant. Use the density of acetic anhydride to determine the amount of this reactant in grams. The reactant that produces less product is the limiting reagent. Use the limiting reagent and the mole ratio from the balanced chemical equation to determine the theoretical yield of aspirin. The actual yield divided by the theoretical yield just calculated (with the result multiplied by 100%) gives the percent yield. Use the formula for percent atom economy to determine that quantity.

Solution:

a) Finding the moles of aspirin from the moles of  $\text{C}_7\text{H}_6\text{O}_3$  (if  $(\text{CH}_3\text{CO})_2\text{O}$  is limiting):

$$\begin{aligned}\text{Moles of aspirin from C}_7\text{H}_6\text{O}_3 &= (3.077 \text{ g C}_7\text{H}_6\text{O}_3) \left( \frac{1 \text{ mol C}_7\text{H}_6\text{O}_3}{138.12 \text{ g C}_7\text{H}_6\text{O}_3} \right) \left( \frac{1 \text{ mol C}_9\text{H}_8\text{O}_4}{1 \text{ mol C}_7\text{H}_6\text{O}_3} \right) \\ &= 0.0222777 \text{ mol C}_9\text{H}_8\text{O}_4\end{aligned}$$

Finding the moles of aspirin from the moles of  $C_4H_6O_3$  (if  $C_7H_6O_3$  is limiting):

$$\text{Mass (g) of } (CH_3CO)_2O = (5.50 \text{ mL } (CH_3CO)_2O) \left( \frac{1.080 \text{ g}}{1 \text{ mL}} \right) = 5.94 \text{ g } (CH_3CO)_2O$$

$$\begin{aligned} \text{Moles of aspirin from } (CH_3CO)_2O &= (5.94 \text{ g } (CH_3CO)_2O) \left( \frac{1 \text{ mol } (CH_3CO)_2O}{102.09 \text{ g } (CH_3CO)_2O} \right) \left( \frac{1 \text{ mol } C_9H_8O_4}{1 \text{ mol } (CH_3CO)_2O} \right) \\ &= 0.058183955 \text{ mol } C_9H_8O_4 \end{aligned}$$

The limiting reactant is  $C_7H_6O_3$ .

b) First, calculate the theoretical yield from the limiting reagent:

$$\begin{aligned} \text{Mass (g) of } C_9H_8O_4 &= (3.077 \text{ g } C_7H_6O_3) \left( \frac{1 \text{ mol } C_7H_6O_3}{138.12 \text{ g } C_7H_6O_3} \right) \left( \frac{1 \text{ mol } C_9H_8O_4}{1 \text{ mol } C_7H_6O_3} \right) \left( \frac{180.15 \text{ g } C_9H_8O_4}{1 \text{ mol } C_9H_8O_4} \right) \\ &= 4.01333 \text{ g } C_9H_8O_4 \end{aligned}$$

$$\text{Percent yield} = \left( \frac{\text{actual yield}}{\text{theoretical yield}} \right) \times 100\% = \left( \frac{3.281 \text{ g}}{4.01333 \text{ g}} \right) \times 100\% = 81.7526 = \mathbf{81.75\% \text{ yield}}$$

- 3.108 Plan: Determine the formula and the molar mass of each compound. The formula gives the relative number of moles of nitrogen present. Multiply the number of moles of nitrogen by its molar mass to find the total mass of nitrogen in 1 mole of compound. Mass percent =  $\frac{\text{total mass of element}}{\text{molar mass of compound}} (100)$ . For part b), convert mass of

ornithine to moles, use the mole ratio between ornithine and urea to find the moles of urea, and then use the ratio between moles of urea and nitrogen to find the moles and mass of nitrogen produced.

Solution:

a) Urea:  $CH_4N_2O$ ,  $\mathcal{M} = 60.06 \text{ g/mol}$

There are 2 moles of N in 1 mole of  $CH_4N_2O$ .

$$\text{Mass (g) of N} = (2 \text{ mol N}) \left( \frac{14.01 \text{ g N}}{1 \text{ mol N}} \right) = 28.02 \text{ g N}$$

$$\text{Mass percent} = \frac{\text{total mass N}}{\text{molar mass of compound}} (100) = \frac{28.02 \text{ g N}}{60.06 \text{ g } CH_4N_2O} (100) = 46.6533 = \mathbf{46.65\% \text{ N in urea}}$$

Arginine:  $C_6H_{15}N_4O_2$ ,  $\mathcal{M} = 175.22 \text{ g/mol}$

There are 4 moles of N in 1 mole of  $C_6H_{15}N_4O_2$ .

$$\text{Mass (g) of N} = (4 \text{ mol N}) \left( \frac{14.01 \text{ g N}}{1 \text{ mol N}} \right) = 56.04 \text{ g N}$$

$$\begin{aligned} \text{Mass percent} &= \frac{\text{total mass N}}{\text{molar mass of compound}} (100) = \frac{56.04 \text{ g N}}{175.22 \text{ g } C_6H_{15}N_4O_2} (100) \\ &= 31.98265 = \mathbf{31.98\% \text{ N in arginine}} \end{aligned}$$

Ornithine:  $C_5H_{13}N_2O_2$ ,  $\mathcal{M} = 133.17 \text{ g/mol}$

There are 2 moles of N in 1 mole of  $C_5H_{13}N_2O_2$ .

$$\text{Mass (g) of N} = (2 \text{ mol N}) \left( \frac{14.01 \text{ g N}}{1 \text{ mol N}} \right) = 28.02 \text{ g N}$$

$$\begin{aligned} \text{Mass percent} &= \frac{\text{total mass N}}{\text{molar mass of compound}} (100) = \frac{28.02 \text{ g N}}{133.17 \text{ g } C_5H_{13}N_2O_2} (100) \\ &= 21.04077 = \mathbf{21.04\% \text{ N in ornithine}} \end{aligned}$$

$$\text{b) Moles of urea} = (135.2 \text{ g } C_5H_{13}N_2O_2) \left( \frac{1 \text{ mol } C_5H_{13}N_2O_2}{133.17 \text{ g } C_5H_{13}N_2O_2} \right) \left( \frac{1 \text{ mol } CH_4N_2O}{1 \text{ mol } C_5H_{13}N_2O_2} \right) = 1.015244 \text{ mol urea}$$

$$\text{Mass (g) of nitrogen} = (1.015244 \text{ mol } CH_4N_2O) \left( \frac{2 \text{ mol N}}{1 \text{ mol } CH_4N_2O} \right) \left( \frac{14.01 \text{ g N}}{1 \text{ mol N}} \right) = 28.447 = \mathbf{28.45 \text{ g N}}$$



- 3.109 Plan: Write and balance the chemical reaction. Use the mole ratio to find the amount of product that should be produced and take 66% of that amount to obtain the actual yield.

Solution:

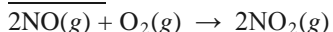

With 6 molecules of NO and 3 molecules of O<sub>2</sub> reacting, 6 molecules of NO<sub>2</sub> can be produced.

If the reaction only has a 66% yield, then (0.66)(6) = 4 molecules of NO<sub>2</sub> will be produced. **Circle A** shows the formation of 4 molecules of NO<sub>2</sub>. Circle B also shows the formation of 4 molecules of NO<sub>2</sub> but also has 2 unreacted molecules of NO and 1 unreacted molecule of O<sub>2</sub>. Since neither reactant is limiting, there will be no unreacted reactant remaining after the reaction is over.

- 3.110 Plan: First balance the given chemical equation. To determine which reactant is limiting, calculate the amount of ZnS formed from each reactant, assuming an excess of the other reactant. The reactant that produces less product is the limiting reagent. Use the limiting reagent and the mole ratio from the balanced chemical equation to determine the theoretical yield of ZnS. The actual yield divided by the theoretical yield just calculated (with the result multiplied by 100%) gives the percent yield. For part b), determine the mass of Zn that does not produce ZnS; use that amount of zinc and the mole ratio between Zn and ZnO in that reaction to determine the mass of ZnO produced. Find the moles of S<sub>8</sub> in the reactant and the moles of S<sub>8</sub> in the product ZnS. The difference between these two amounts is the moles of S<sub>8</sub> in SO<sub>2</sub>.

Solution:

a) The balanced equation is  $8\text{Zn}(s) + \text{S}_8(s) \rightarrow 8\text{ZnS}(s)$ .

Finding the limiting reagent:

Finding the moles of ZnS from the moles of Zn (if S<sub>8</sub> is limiting):

$$\text{Moles of ZnS from Zn} = (83.2 \text{ g Zn}) \left( \frac{1 \text{ mol Zn}}{65.41 \text{ g Zn}} \right) \left( \frac{8 \text{ mol ZnS}}{8 \text{ mol Zn}} \right) = 1.27198 \text{ mol ZnS}$$

Finding the moles of ZnS from the moles of S<sub>8</sub> (if Zn is limiting):

$$\text{Moles of ZnS from S}_8 = (52.4 \text{ g S}_8) \left( \frac{1 \text{ mol S}_8}{256.56 \text{ g S}_8} \right) \left( \frac{8 \text{ mol ZnS}}{1 \text{ mol S}_8} \right) = 1.6339 \text{ mol ZnS}$$

The zinc will produce less zinc sulfide, thus, zinc is the limiting reactant and will first be used to determine the theoretical yield and then the percent yield.

$$\begin{aligned} \text{Theoretical yield (g) of ZnS} &= (83.2 \text{ g Zn}) \left( \frac{1 \text{ mol Zn}}{65.41 \text{ g Zn}} \right) \left( \frac{8 \text{ mol ZnS}}{8 \text{ mol Zn}} \right) \left( \frac{97.48 \text{ g ZnS}}{1 \text{ mol ZnS}} \right) \\ &= 123.9923 \text{ g ZnS (unrounded)} \end{aligned}$$

$$\text{Percent yield} = \left( \frac{\text{actual Yield}}{\text{theoretical Yield}} \right) \times 100\% = \left( \frac{104.4 \text{ g}}{123.9923 \text{ g}} \right) \times 100\% = 84.1988 = \mathbf{84.2\% \text{ yield}}$$

b) The reactions with oxygen are:

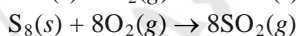
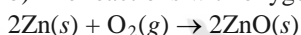

The theoretical yield indicates that 84.2% of the zinc produced zinc sulfide so (100 – 84.2)% = 15.8% of the zinc became zinc oxide. This allows the calculation of the amount of zinc oxide formed.

$$\text{Mass (g) of Zn that does not produce ZnS} = (83.2 \text{ g Zn}) \left( \frac{15.8\%}{100\%} \right) = 13.1456 \text{ g ZnS}$$

$$\text{Mass (g) of ZnO} = (13.1456 \text{ g Zn}) \left( \frac{1 \text{ mol Zn}}{65.41 \text{ g Zn}} \right) \left( \frac{2 \text{ mol ZnO}}{2 \text{ mol Zn}} \right) \left( \frac{81.41 \text{ g ZnO}}{1 \text{ mol ZnO}} \right) = 16.3612 = \mathbf{16.4 \text{ g ZnO}}$$

The calculation is slightly different for the sulfur. We need to determine the amount of sulfur not in zinc sulfide. The sulfur not in the zinc sulfide must be in sulfur dioxide. The amount of sulfur not in zinc sulfide will be converted to the mass of sulfur dioxide.

$$\text{Moles of S}_8 \text{ in original S}_8 \text{ reactant} = (52.4 \text{ g S}_8) \left( \frac{1 \text{ mol S}_8}{256.56 \text{ g S}_8} \right) = 0.204241 \text{ mol S}_8$$

$$\text{Moles of S}_8 \text{ in ZnS product} = (104.4 \text{ g ZnS}) \left( \frac{1 \text{ mol ZnS}}{97.48 \text{ g ZnS}} \right) \left( \frac{1 \text{ mol S}_8}{8 \text{ mol ZnS}} \right) = 0.133874 \text{ mol S}_8$$

$$\text{Moles of S}_8 \text{ in SO}_2 = 0.204241 - 0.133874 \text{ mol} = 0.070367 \text{ mol S}_8$$

$$\text{Mass (g) of SO}_2 = (0.070367 \text{ mol S}_8) \left( \frac{8 \text{ mol SO}_2}{1 \text{ mol S}_8} \right) \left( \frac{64.07 \text{ g SO}_2}{1 \text{ mol SO}_2} \right) = 36.0673 = \mathbf{36.1 \text{ g SO}_2}$$

3.111 Plan: Use the given values of x to find the molar mass of each compound. . To determine which reactant is limiting, calculate the amount of either product formed from each reactant, assuming an excess of the other reactants. The reactant that produces the smallest amount of product is the limiting reagent. To find the mass of excess reactants, find the mass of each excess reactant that is required to react with the limiting reagent and subtract that mass from the starting mass.

a) x = 0

$$\text{La}_2\text{Sr}_0\text{CuO}_4 = 2(138.9 \text{ g/mol La}) + 0(87.62 \text{ g/mol Sr}) + 1(63.55 \text{ g/mol Cu}) + 4(16.00 \text{ g/mol O}) = \mathbf{405.4 \text{ g/mol}}$$

x = 1

$$\text{La}_1\text{Sr}_1\text{CuO}_4 = 1(138.9 \text{ g/mol La}) + 1(87.62 \text{ g/mol Sr}) + 1(63.55 \text{ g/mol Cu}) + 4(16.00 \text{ g/mol O}) = \mathbf{354.1 \text{ g/mol}}$$

x = 0.163

$$\begin{aligned} \text{La}_{(2-0.163)}\text{Sr}_{0.163}\text{CuO}_4 &= \text{La}_{1.837}\text{Sr}_{0.163}\text{CuO}_4 \\ &= 1.837(138.9 \text{ g/mol La}) + 0.163(87.62 \text{ g/mol Sr}) + 1(63.55 \text{ g/mol Cu}) + 4(16.00 \text{ g/mol O}) \\ &= \mathbf{397.0 \text{ g/mol}} \end{aligned}$$

b) Assuming x grams to be the "equal" mass leads to:

$$\begin{aligned} \text{Moles of product from BaCO}_3 &= (x \text{ g BaCO}_3) \left( \frac{1 \text{ mol BaCO}_3}{197.3 \text{ g BaCO}_3} \right) \left( \frac{2 \text{ mol YBa}_2\text{Cu}_3\text{O}_7}{4 \text{ mol BaCO}_3} \right) \\ &= 0.002534x \text{ mol product} \end{aligned}$$

$$\text{Moles of product from CuO} = (x \text{ g CuO}) \left( \frac{1 \text{ mol CuO}}{79.55 \text{ g CuO}} \right) \left( \frac{2 \text{ mol YBa}_2\text{Cu}_3\text{O}_7}{6 \text{ mol CuO}} \right) = 0.004190x \text{ mol product}$$

$$\text{Moles of product from Y}_2\text{O}_3 = (x \text{ g Y}_2\text{O}_3) \left( \frac{1 \text{ mol Y}_2\text{O}_3}{225.82 \text{ g Y}_2\text{O}_3} \right) \left( \frac{2 \text{ mol YBa}_2\text{Cu}_3\text{O}_7}{1 \text{ mol Y}_2\text{O}_3} \right) = 0.008857x \text{ mol product}$$

**BaCO<sub>3</sub>** is the limiting reactant.

c) These calculations are based on the limiting reactant.

BaCO<sub>3</sub> remaining = 0% (limiting reagent)

$$\begin{aligned} \text{CuO remaining} &= x \text{ g CuO} - (x \text{ g BaCO}_3) \left( \frac{1 \text{ mol BaCO}_3}{197.3 \text{ g BaCO}_3} \right) \left( \frac{6 \text{ mol CuO}}{4 \text{ mol BaCO}_3} \right) \left( \frac{79.55 \text{ g CuO}}{1 \text{ mol CuO}} \right) \\ &= 0.39521x \text{ g CuO} \end{aligned}$$

$$\text{Percent CuO} = \left( \frac{0.39521 x \text{ g}}{x \text{ g}} \right) \times 100\% = 39.521 = \mathbf{39.52\% \text{ CuO remaining}}$$

$$\begin{aligned} \text{Y}_2\text{O}_3 \text{ remaining} &= x \text{ g Y}_2\text{O}_3 - (x \text{ g BaCO}_3) \left( \frac{1 \text{ mol BaCO}_3}{197.3 \text{ g BaCO}_3} \right) \left( \frac{1 \text{ mol Y}_2\text{O}_3}{4 \text{ mol BaCO}_3} \right) \left( \frac{225.82 \text{ g Y}_2\text{O}_3}{1 \text{ mol Y}_2\text{O}_3} \right) \\ &= 0.713862x \text{ g Y}_2\text{O}_3 \end{aligned}$$

$$\text{Percent Y}_2\text{O}_3 = \left( \frac{0.713862 x \text{ g}}{x \text{ g}} \right) \times 100\% = 71.3862 = \mathbf{71.39\% \text{ Y}_2\text{O}_3 \text{ remaining}}$$

# CHAPTER 4 THREE MAJOR CLASSES OF CHEMICAL REACTIONS

---

## END-OF-CHAPTER PROBLEMS

- 4.1 Plan: Review the discussion on the polar nature of water.  
Solution:  
Water is polar because the distribution of its bonding electrons is unequal, resulting in polar bonds, and the shape of the molecule (bent) is unsymmetrical.
- 4.2 Plan: Solutions that conduct an electric current contain electrolytes.  
Solution:  
Ions must be present in an aqueous solution for it to conduct an electric current. Ions come from ionic compounds or from other electrolytes such as acids and bases.
- 4.3 Plan: Review the discussion on ionic compounds in water.  
Solution:  
The ions on the surface of the solid attract the water molecules (cations attract the “negative” ends and anions attract the “positive” ends of the water molecules). The interaction of the solvent with the ions overcomes the attraction of the oppositely charged ions for one another, and they are released into the solution.
- 4.4 Plan: Recall that ionic compounds dissociate into their ions when dissolved in water. Examine the charges of the ions in each scene and the ratio of cations to anions.  
Solution:  
a)  $\text{CaCl}_2$  dissociates to produce one  $\text{Ca}^{2+}$  ion for every two  $\text{Cl}^-$  ions. **Scene B** contains four  $2+$  ions and twice that number of  $1-$  ions.  
b)  $\text{Li}_2\text{SO}_4$  dissociates to produce two  $\text{Li}^+$  ions for every one  $\text{SO}_4^{2-}$  ion. **Scene C** contains eight  $1+$  ions and half as many  $2-$  ions.  
c)  $\text{NH}_4\text{Br}$  dissociates to produce one  $\text{NH}_4^+$  ion for every one  $\text{Br}^-$  ion. **Scene A** contains equal numbers of  $1+$  and  $1-$  ions.
- 4.5 Plan: Write the formula for magnesium nitrate and note the ratio of magnesium ions to nitrate ions.  
Solution:  
Upon dissolving the salt in water, magnesium nitrate,  $\text{Mg}(\text{NO}_3)_2$ , would dissociate to form one  $\text{Mg}^{2+}$  ion for every two  $\text{NO}_3^-$  ions, thus forming twice as many nitrate ions. **Scene B** best represents a volume of magnesium nitrate solution. Only Scene B has twice as many nitrate ions (red circles) as magnesium ions (blue circles).
- 4.6 Plan: Review the discussion of ionic compounds in water.  
Solution:  
In some ionic compounds, the force of the attraction between the ions is so strong that it cannot be overcome by the interaction of the ions with the water molecules. These compounds will be insoluble in water.
- 4.7 Plan: Review the discussion of covalent compounds in water.  
Solution:  
Some covalent compounds that contain the **hydrogen atom** dissociate into ions when dissolved in water. These compounds form **acidic** solutions in water; three examples are **HCl**, **HNO<sub>3</sub>**, and **HBr**.
- 4.8 Plan: Compounds that are soluble in water tend to be ionic compounds or covalent compounds that have polar bonds. Many ionic compounds are soluble in water because the attractive force between the oppositely charged ions in an ionic compound are replaced with an attractive force between the polar water molecule and the ions when the compound is dissolved in water. Covalent compounds with polar bonds are often soluble in water since the polar bonds of the covalent compound interact with those in water.

Solution:

- Benzene, a covalent compound, is likely to be **insoluble** in water because it is nonpolar and water is polar.
- Sodium hydroxide (NaOH) is an ionic compound and is therefore likely to be **soluble** in water.
- Ethanol (CH<sub>3</sub>CH<sub>2</sub>OH) will likely be **soluble** in water because it contains a polar –OH bond like water.
- Potassium acetate (KC<sub>2</sub>H<sub>3</sub>O<sub>2</sub>) is an ionic compound and will likely be **soluble** in water.

- 4.9 Plan: Compounds that are soluble in water tend to be ionic compounds or covalent compounds that have polar bonds. Many ionic compounds are soluble in water because the attractive force between the oppositely charged ions in an ionic compound are replaced with an attractive force between the polar water molecule and the ions when the compound is dissolved in water. Covalent compounds with polar bonds are often soluble in water since the polar bonds of the covalent compound interact with those in water.

Solution:

- Lithium nitrate is an ionic compound and is expected to be **soluble** in water.
- Glycine (H<sub>2</sub>NCH<sub>2</sub>COOH) is a covalent compound, but it contains polar N–H and O–H bonds. This would make the molecule interact well with polar water molecules, and make it likely that it would be **soluble**.
- Pentane (C<sub>5</sub>H<sub>12</sub>) has no bonds of significant polarity, so it would be expected to be **insoluble** in the polar solvent water.
- Ethylene glycol (HOCH<sub>2</sub>CH<sub>2</sub>OH) molecules contain polar O–H bonds, similar to water, so it would be expected to be **soluble**.

- 4.10 Plan: Substances whose aqueous solutions conduct an electric current are electrolytes such as ionic compounds, acids, and bases.

Solution:

- Cesium bromide, CsBr, is a soluble ionic compound, and a solution of this salt in water contains Cs<sup>+</sup> and Br<sup>–</sup> ions. Its solution **conducts** an electric current.
  - HI is a strong acid that dissociates completely in water. Its aqueous solution contains H<sup>+</sup> and I<sup>–</sup> ions, so it **conducts** an electric current.
- 4.11 Plan: Substances whose aqueous solutions conduct an electric current are electrolytes such as ionic compounds, acids, and bases.
- Solution:
- Potassium sulfate, K<sub>2</sub>SO<sub>4</sub>, is an ionic compound that is soluble in water, producing K<sup>+</sup> and SO<sub>4</sub><sup>2–</sup> ions. Its solution **conducts** an electric current.
  - Sucrose is neither an ionic compound, an acid, nor a base, so it would be a nonelectrolyte (even though it's soluble in water). Its solution does **not conduct** an electric current.

- 4.12 Plan: To determine the total moles of ions released, write an equation that shows the compound dissociating into ions with the correct molar ratios. Convert mass and formula units to moles of compound and use the molar ratio to convert moles of compound to moles of ions.

Solution:

- Each mole of K<sub>3</sub>PO<sub>4</sub> forms 3 moles of K<sup>+</sup> ions and 1 mole of PO<sub>4</sub><sup>3–</sup> ions, or a total of 4 moles of ions:

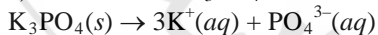

$$\text{Moles of ions} = (0.75 \text{ mol K}_3\text{PO}_4) \left( \frac{4 \text{ mol ions}}{1 \text{ mol K}_3\text{PO}_4} \right) = \mathbf{3.0 \text{ mol of ions}}$$

- Each mole of NiBr<sub>2</sub>•3H<sub>2</sub>O forms 1 mole of Ni<sup>2+</sup> ions and 2 moles of Br<sup>–</sup> ions, or a total of 3 moles of ions: NiBr<sub>2</sub>•3H<sub>2</sub>O(s) → Ni<sup>2+</sup>(aq) + 2Br<sup>–</sup>(aq). The waters of hydration become part of the larger bulk of water. Convert mass to moles using the molar mass.

$$\begin{aligned} \text{Moles of ions} &= (6.88 \times 10^{-3} \text{ g NiBr}_2 \cdot 3\text{H}_2\text{O}) \left( \frac{1 \text{ mol NiBr}_2 \cdot 3\text{H}_2\text{O}}{272.54 \text{ g NiBr}_2 \cdot 3\text{H}_2\text{O}} \right) \left( \frac{3 \text{ mol ions}}{1 \text{ mol NiBr}_2 \cdot 3\text{H}_2\text{O}} \right) \\ &= 7.5732 \times 10^{-5} = \mathbf{7.57 \times 10^{-5} \text{ mol of ions}} \end{aligned}$$

c) Each mole of  $\text{FeCl}_3$  forms 1 mole of  $\text{Fe}^{3+}$  ions and 3 moles of  $\text{Cl}^-$  ions, or a total of 4 moles of ions:  
 $\text{FeCl}_3(s) \rightarrow \text{Fe}^{3+}(aq) + 3\text{Cl}^-(aq)$ . Recall that a mole contains  $6.022 \times 10^{23}$  entities, so a mole of  $\text{FeCl}_3$  contains  $6.022 \times 10^{23}$  units of  $\text{FeCl}_3$ , more easily expressed as formula units.

$$\begin{aligned} \text{Moles of ions} &= \left(2.23 \times 10^{22} \text{ FU FeCl}_3\right) \left(\frac{1 \text{ mol FeCl}_3}{6.022 \times 10^{23} \text{ FU FeCl}_3}\right) \left(\frac{4 \text{ mol ions}}{1 \text{ mol FeCl}_3}\right) \\ &= 0.148124 = \mathbf{0.148 \text{ mol of ions}} \end{aligned}$$

4.13 Plan: To determine the total moles of ions released, write an equation that shows the compound dissociating into ions with the correct molar ratios. Convert mass and formula units to moles of compound and use the molar ratio to convert moles of compound to moles of ions.

Solution:

a) Each mole of  $\text{Na}_2\text{HPO}_4$  forms 2 moles of  $\text{Na}^+$  ions and 1 mole of  $\text{HPO}_4^{2-}$  ions, or a total of 3 moles of ions:  
 $\text{Na}_2\text{HPO}_4(s) \rightarrow 2\text{Na}^+(aq) + \text{HPO}_4^{2-}(aq)$ .

$$\text{Moles of ions} = (0.734 \text{ mol Na}_2\text{HPO}_4) \left(\frac{3 \text{ mol ions}}{1 \text{ mol Na}_2\text{HPO}_4}\right) = 2.202 = \mathbf{2.20 \text{ mol of ions}}$$

b) Each mole of  $\text{CuSO}_4 \cdot 5\text{H}_2\text{O}$  forms 1 mole of  $\text{Cu}^{2+}$  ions and 1 mole of  $\text{SO}_4^{2-}$  ions, or a total of 2 moles of ions:  
 $\text{CuSO}_4 \cdot 5\text{H}_2\text{O}(s) \rightarrow \text{Cu}^{2+}(aq) + \text{SO}_4^{2-}(aq)$ . The waters of hydration become part of the larger bulk of water. Convert mass to moles using the molar mass.

$$\begin{aligned} \text{Moles of ions} &= (3.86 \text{ g CuSO}_4 \cdot 5\text{H}_2\text{O}) \left(\frac{1 \text{ mol CuSO}_4 \cdot 5\text{H}_2\text{O}}{249.70 \text{ g CuSO}_4 \cdot 5\text{H}_2\text{O}}\right) \left(\frac{2 \text{ mol ions}}{1 \text{ mol CuSO}_4 \cdot 5\text{H}_2\text{O}}\right) \\ &= 3.0907 \times 10^{-2} = \mathbf{3.09 \times 10^{-2} \text{ mol of ions}} \end{aligned}$$

c) Each mole of  $\text{NiCl}_2$  forms 1 mole of  $\text{Ni}^{2+}$  ions and 2 moles of  $\text{Cl}^-$  ions, or a total of 3 moles of ions:  
 $\text{NiCl}_2(s) \rightarrow \text{Ni}^{2+}(aq) + 2\text{Cl}^-(aq)$ . Recall that a mole contains  $6.022 \times 10^{23}$  entities, so a mole of  $\text{NiCl}_2$  contains  $6.022 \times 10^{23}$  units of  $\text{NiCl}_2$ , more easily expressed as formula units.

$$\begin{aligned} \text{Moles of ions} &= \left(8.66 \times 10^{20} \text{ FU NiCl}_2\right) \left(\frac{1 \text{ mol NiCl}_2}{6.022 \times 10^{23} \text{ FU NiCl}_2}\right) \left(\frac{3 \text{ mol ions}}{1 \text{ mol NiCl}_2}\right) \\ &= 4.31418 \times 10^{-3} = \mathbf{4.31 \times 10^{-3} \text{ mol of ions}} \end{aligned}$$

4.14 Plan: To determine the total moles of ions released, write an equation that shows the compound dissociating into ions with the correct molar ratios. Convert the information given to moles of compound and use the molar ratio to convert moles of compound to moles of ions. Avogadro's number is used to convert moles of ions to numbers of ions.

Solution:

a) Each mole of  $\text{AlCl}_3$  forms 1 mole of  $\text{Al}^{3+}$  ions and 3 moles of  $\text{Cl}^-$  ions:  $\text{AlCl}_3(s) \rightarrow \text{Al}^{3+}(aq) + 3\text{Cl}^-(aq)$ . Molarity and volume must be converted to moles of  $\text{AlCl}_3$ .

$$\text{Moles of AlCl}_3 = (130. \text{ mL}) \left(\frac{10^{-3} \text{ L}}{1 \text{ mL}}\right) \left(\frac{0.45 \text{ mol AlCl}_3}{\text{L}}\right) = 0.0585 \text{ mol AlCl}_3$$

$$\text{Moles of Al}^{3+} = (0.0585 \text{ mol AlCl}_3) \left(\frac{1 \text{ mol Al}^{3+}}{1 \text{ mol AlCl}_3}\right) = 0.0585 = \mathbf{0.058 \text{ mol Al}^{3+}}$$

$$\text{Number of Al}^{3+} \text{ ions} = (0.0585 \text{ mol Al}^{3+}) \left(\frac{6.022 \times 10^{23} \text{ Al}^{3+}}{1 \text{ mol Al}^{3+}}\right) = 3.52287 \times 10^{22} = \mathbf{3.5 \times 10^{22} \text{ Al}^{3+} \text{ ions}}$$

$$\text{Moles of Cl}^- = (0.0585 \text{ mol AlCl}_3) \left(\frac{3 \text{ mol Cl}^-}{1 \text{ mol AlCl}_3}\right) = 0.1755 = \mathbf{0.18 \text{ mol Cl}^-}$$

$$\text{Number of Cl}^- \text{ ions} = (0.1755 \text{ mol Cl}^-) \left(\frac{6.022 \times 10^{23} \text{ Cl}^-}{1 \text{ mol Cl}^-}\right) = 1.05686 \times 10^{23} = \mathbf{1.1 \times 10^{23} \text{ Cl}^- \text{ ions}}$$

b) Each mole of  $\text{Li}_2\text{SO}_4$  forms 2 moles of  $\text{Li}^+$  ions and 1 mole of  $\text{SO}_4^{2-}$  ions:  $\text{Li}_2\text{SO}_4(s) \rightarrow 2\text{Li}^+(aq) + \text{SO}_4^{2-}(aq)$ .

$$\text{Moles of Li}_2\text{SO}_4 = (9.80 \text{ mL}) \left( \frac{10^{-3} \text{ L}}{1 \text{ mL}} \right) \left( \frac{2.59 \text{ g Li}_2\text{SO}_4}{1 \text{ L}} \right) \left( \frac{1 \text{ mol Li}_2\text{SO}_4}{109.95 \text{ g Li}_2\text{SO}_4} \right) = 2.3085 \times 10^{-4} \text{ mol Li}_2\text{SO}_4$$

$$\text{Moles of Li}^+ = (2.3085 \times 10^{-4} \text{ mol Li}_2\text{SO}_4) \left( \frac{2 \text{ mol Li}^+}{1 \text{ mol Li}_2\text{SO}_4} \right) = 4.6170 \times 10^{-4} = \mathbf{4.62 \times 10^{-4} \text{ mol Li}^+}$$

$$\text{Number of Li}^+ \text{ ions} = (4.6170 \times 10^{-4} \text{ mol Li}^+) \left( \frac{6.022 \times 10^{23} \text{ Li}^+}{1 \text{ mol Li}^+} \right) = 2.7804 \times 10^{20} = \mathbf{2.78 \times 10^{20} \text{ Li}^+ \text{ ions}}$$

$$\text{Moles of SO}_4^{2-} = (2.3085 \times 10^{-4} \text{ mol Li}_2\text{SO}_4) \left( \frac{1 \text{ mol SO}_4^{2-}}{1 \text{ mol Li}_2\text{SO}_4} \right) = 2.3085 \times 10^{-4} = \mathbf{2.31 \times 10^{-4} \text{ mol SO}_4^{2-}}$$

$$\begin{aligned} \text{Number of SO}_4^{2-} \text{ ions} &= (2.3085 \times 10^{-4} \text{ mol SO}_4^{2-}) \left( \frac{6.022 \times 10^{23} \text{ SO}_4^{2-}}{1 \text{ mol SO}_4^{2-}} \right) \\ &= 1.39018 \times 10^{20} = \mathbf{1.39 \times 10^{20} \text{ SO}_4^{2-} \text{ ions}} \end{aligned}$$

c) Each mole of  $\text{KBr}$  forms 1 mole of  $\text{K}^+$  ions and 1 mole of  $\text{Br}^-$  ions:  $\text{KBr}(s) \rightarrow \text{K}^+(aq) + \text{Br}^-(aq)$ .

$$\text{Moles of KBr} = (245 \text{ mL}) \left( \frac{10^{-3} \text{ L}}{1 \text{ mL}} \right) \left( \frac{3.68 \times 10^{22} \text{ FU KBr}}{\text{L}} \right) \left( \frac{1 \text{ mol KBr}}{6.022 \times 10^{23} \text{ FU KBr}} \right) = 0.01497 \text{ mol KBr}$$

$$\text{Moles of K}^+ = (0.01497 \text{ mol KBr}) \left( \frac{1 \text{ mol K}^+}{1 \text{ mol KBr}} \right) = 0.01497 = \mathbf{1.50 \times 10^{-2} \text{ mol K}^+}$$

$$\text{Number of K}^+ \text{ ions} = (0.01497 \text{ mol K}^+) \left( \frac{6.022 \times 10^{23} \text{ K}^+}{1 \text{ mol K}^+} \right) = 9.016 \times 10^{21} = \mathbf{9.02 \times 10^{21} \text{ K}^+ \text{ ions}}$$

$$\text{Moles of Br}^- = (0.01497 \text{ mol KBr}) \left( \frac{1 \text{ mol Br}^-}{1 \text{ mol KBr}} \right) = 0.01497 = \mathbf{1.50 \times 10^{-2} \text{ mol Br}^-}$$

$$\text{Number of Br}^- \text{ ions} = (0.01497 \text{ mol Br}^-) \left( \frac{6.022 \times 10^{23} \text{ Br}^-}{1 \text{ mol Br}^-} \right) = 9.016 \times 10^{21} = \mathbf{9.02 \times 10^{21} \text{ Br}^- \text{ ions}}$$

4.15 Plan: To determine the total moles of ions released, write an equation that shows the compound dissociating into ions with the correct molar ratios. Convert the information given to moles of compound and use the molar ratio to convert moles of compound to moles of ions. Avogadro's number is used to convert moles of ions to numbers of ions.

Solution:

a) Each mole of  $\text{MgCl}_2$  forms 1 mole of  $\text{Mg}^{2+}$  ions and 2 moles of  $\text{Cl}^-$  ions:  $\text{MgCl}_2(s) \rightarrow \text{Mg}^{2+}(aq) + 2\text{Cl}^-(aq)$ .

$$\text{Moles of MgCl}_2 = (88. \text{ mL}) \left( \frac{10^{-3} \text{ L}}{1 \text{ mL}} \right) \left( \frac{1.75 \text{ mol MgCl}_2}{\text{L}} \right) = 0.154 \text{ mol MgCl}_2$$

$$\text{Moles of Mg}^{2+} = (0.154 \text{ mol MgCl}_2) \left( \frac{1 \text{ mol Mg}^{2+}}{1 \text{ mol MgCl}_2} \right) = 0.154 = \mathbf{0.15 \text{ mol Mg}^{2+}}$$

$$\text{Number of Mg}^{2+} \text{ ions} = (0.154 \text{ mol Mg}^{2+}) \left( \frac{6.022 \times 10^{23} \text{ Mg}^{2+}}{1 \text{ mol Mg}^{2+}} \right) = 9.27388 \times 10^{22} = \mathbf{9.3 \times 10^{22} \text{ Mg}^{2+} \text{ ions}}$$

$$\text{Moles of Cl}^- = (0.154 \text{ mol MgCl}_2) \left( \frac{2 \text{ mol Cl}^-}{1 \text{ mol MgCl}_2} \right) = 0.308 = \mathbf{0.31 \text{ mol Cl}^-}$$

$$\text{Number of Cl}^- \text{ ions} = (0.308 \text{ mol Cl}^-) \left( \frac{6.022 \times 10^{23} \text{ Cl}^-}{1 \text{ mol Cl}^-} \right) = 1.854776 \times 10^{23} = \mathbf{1.9 \times 10^{23} \text{ Cl}^- \text{ ions}}$$

b) Each mole of  $\text{Al}_2(\text{SO}_4)_3$  forms 2 moles of  $\text{Al}^{3+}$  ions and 3 moles of  $\text{SO}_4^{2-}$  ions:  
 $\text{Al}_2(\text{SO}_4)_3(s) \rightarrow 2\text{Al}^{3+}(aq) + 3\text{SO}_4^{2-}(aq)$ .

$$\begin{aligned} \text{Moles of Al}_2(\text{SO}_4)_3 &= (321 \text{ mL}) \left( \frac{10^{-3} \text{ L}}{1 \text{ mL}} \right) \left( \frac{0.22 \text{ g Al}_2(\text{SO}_4)_3}{1 \text{ L}} \right) \left( \frac{1 \text{ mol Al}_2(\text{SO}_4)_3}{342.17 \text{ g Al}_2(\text{SO}_4)_3} \right) \\ &= 2.06389 \times 10^{-4} \text{ mol Al}_2(\text{SO}_4)_3 \end{aligned}$$

$$\text{Moles of Al}^{3+} = (2.06389 \times 10^{-4} \text{ mol Al}_2(\text{SO}_4)_3) \left( \frac{2 \text{ mol Al}^{3+}}{1 \text{ mol Al}_2(\text{SO}_4)_3} \right) = 4.12777 \times 10^{-4} = \mathbf{4.1 \times 10^{-4} \text{ mol Al}^{3+}}$$

$$\text{Number of Al}^{3+} \text{ ions} = (4.12777 \times 10^{-4} \text{ mol Al}^{3+}) \left( \frac{6.022 \times 10^{23} \text{ Al}^{3+}}{1 \text{ mol Al}^{3+}} \right) = 2.4857 \times 10^{20} = \mathbf{2.5 \times 10^{20} \text{ Al}^{3+} \text{ ions}}$$

$$\text{Moles of SO}_4^{2-} = (2.06389 \times 10^{-4} \text{ mol Al}_2(\text{SO}_4)_3) \left( \frac{3 \text{ mol SO}_4^{2-}}{1 \text{ mol Al}_2(\text{SO}_4)_3} \right) = 6.191659 \times 10^{-4} = \mathbf{6.2 \times 10^{-4} \text{ mol SO}_4^{2-}}$$

$$\begin{aligned} \text{Number of SO}_4^{2-} \text{ ions} &= (6.191659 \times 10^{-4} \text{ mol SO}_4^{2-}) \left( \frac{6.022 \times 10^{23} \text{ SO}_4^{2-}}{1 \text{ mol SO}_4^{2-}} \right) \\ &= 3.7286 \times 10^{20} = \mathbf{3.7 \times 10^{20} \text{ SO}_4^{2-} \text{ ions}} \end{aligned}$$

c) Each mole of  $\text{CsNO}_3$  forms 1 mole of  $\text{Cs}^+$  ions and 1 mole of  $\text{NO}_3^-$  ions:  $\text{CsNO}_3(s) \rightarrow \text{Cs}^+(aq) + \text{NO}_3^-(aq)$

$$\text{Moles of CsNO}_3 = (1.65 \text{ L}) \left( \frac{8.83 \times 10^{21} \text{ FU CsNO}_3}{\text{L}} \right) \left( \frac{1 \text{ mol CsNO}_3}{6.022 \times 10^{23} \text{ FU CsNO}_3} \right) = 0.024194 \text{ mol CsNO}_3$$

$$\text{Moles of Cs}^+ = (0.024194 \text{ mol CsNO}_3) \left( \frac{1 \text{ mol Cs}^+}{1 \text{ mol CsNO}_3} \right) = 0.024194 = \mathbf{0.0242 \text{ mol Cs}^+}$$

$$\text{Number of Cs}^+ \text{ ions} = (0.024194 \text{ mol Cs}^+) \left( \frac{6.022 \times 10^{23} \text{ Cs}^+}{1 \text{ mol Cs}^+} \right) = 1.45695 \times 10^{22} = \mathbf{1.46 \times 10^{22} \text{ Cs}^+ \text{ ions}}$$

$$\text{Moles of NO}_3^- = (0.024194 \text{ mol CsNO}_3) \left( \frac{1 \text{ mol NO}_3^-}{1 \text{ mol CsNO}_3} \right) = 0.024194 = \mathbf{0.0242 \text{ mol NO}_3^-}$$

$$\text{Number of NO}_3^- \text{ ions} = (0.024194 \text{ mol NO}_3^-) \left( \frac{6.022 \times 10^{23} \text{ NO}_3^-}{1 \text{ mol NO}_3^-} \right) = 1.45695 \times 10^{22} = \mathbf{1.46 \times 10^{22} \text{ NO}_3^- \text{ ions}}$$

4.16 Plan: The acids in this problem are all strong acids, so you can assume that all acid molecules dissociate completely to yield  $\text{H}^+$  ions and associated anions. One mole of  $\text{HClO}_4$ ,  $\text{HNO}_3$ , and  $\text{HCl}$  each produce one mole of  $\text{H}^+$  upon dissociation, so moles  $\text{H}^+$  = moles acid. Calculate the moles of acid by multiplying the molarity (moles/L) by the volume in liters.

Solution:



$$\text{Moles H}^+ = \text{mol HClO}_4 = (1.40 \text{ L}) \left( \frac{0.25 \text{ mol}}{1 \text{ L}} \right) = \mathbf{0.35 \text{ mol H}^+}$$



$$\text{Moles H}^+ = \text{mol HNO}_3 = (6.8 \text{ mL}) \left( \frac{10^{-3} \text{ L}}{1 \text{ mL}} \right) \left( \frac{0.92 \text{ mol}}{1 \text{ L}} \right) = 6.256 \times 10^{-3} = \mathbf{6.3 \times 10^{-3} \text{ mol H}^+}$$



$$\text{Moles H}^+ = \text{mol HCl} = (2.6 \text{ L}) \left( \frac{0.085 \text{ mol}}{1 \text{ L}} \right) = 0.221 = \mathbf{0.22 \text{ mol H}^+}$$

- 4.17 **Plan:** The acids in this problem are all strong acids, so you can assume that all acid molecules dissociate completely to yield  $\text{H}^+$  ions and associated anions. One mole of  $\text{HBr}$ ,  $\text{HI}$ , and  $\text{HNO}_3$  each produce one mole of  $\text{H}^+$  upon dissociation, so moles  $\text{H}^+$  = moles acid. Calculate the moles of acid by multiplying the molarity (moles/L) by the volume in liters.

**Solution:**



$$\text{Moles H}^+ = \text{mol HBr} = (1.4 \text{ mL}) \left( \frac{10^{-3} \text{ L}}{1 \text{ mL}} \right) \left( \frac{0.75 \text{ mol}}{1 \text{ L}} \right) = 1.05 \times 10^{-3} = \mathbf{1.0 \times 10^{-3} \text{ mol H}^+}$$



$$\text{Moles H}^+ = \text{mol HI} = (2.47 \text{ mL}) \left( \frac{10^{-3} \text{ L}}{1 \text{ mL}} \right) \left( \frac{1.98 \text{ mol}}{1 \text{ L}} \right) = 4.8906 \times 10^{-3} = \mathbf{4.89 \times 10^{-3} \text{ mol H}^+}$$



$$\text{Moles H}^+ = \text{mol HNO}_3 = (395 \text{ mL}) \left( \frac{10^{-3} \text{ L}}{1 \text{ mL}} \right) \left( \frac{0.270 \text{ mol}}{1 \text{ L}} \right) = 0.10665 = \mathbf{0.107 \text{ mol H}^+}$$

- 4.18 **Plan:** Convert the mass of the seawater in kg to g and use the density to convert the mass of the seawater to volume in L. Convert mass of each compound to moles of compound and then use the molar ratio in the dissociation of the compound to find the moles of each ion. The molarity of each ion is the moles of ion divided by the volume of the seawater. To find the total molarity of the alkali metal ions [Group 1A(1)], add the moles of the alkali metal ions and divide by the volume of the seawater. Perform the same calculation to find the total molarity of the alkaline earth metal ions [Group 2A(2)] and the anions (the negatively charged ions).

**Solution:**

a) The volume of the seawater is needed.

$$\text{Volume (L) of seawater} = (1.00 \text{ kg}) \left( \frac{10^3 \text{ g}}{1 \text{ kg}} \right) \left( \frac{\text{cm}^3}{1.025 \text{ g}} \right) \left( \frac{1 \text{ mL}}{1 \text{ cm}^3} \right) \left( \frac{10^{-3} \text{ L}}{1 \text{ mL}} \right) = 0.97560976 \text{ L}$$

The moles of each ion are needed. If an ion comes from more than one source, the total moles are needed.

**NaCl:**

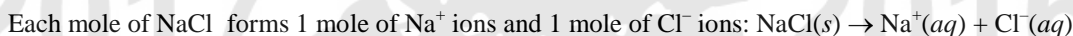

$$\text{Moles of NaCl} = (26.5 \text{ g NaCl}) \left( \frac{1 \text{ mol NaCl}}{58.44 \text{ g NaCl}} \right) = 0.4534565 \text{ mol NaCl}$$

$$\text{Moles of Na}^+ = (0.4534565 \text{ mol NaCl}) \left( \frac{1 \text{ mol Na}^+}{1 \text{ mol NaCl}} \right) = 0.4534565 \text{ mol Na}^+$$

$$\text{Moles of Cl}^- = (0.4534565 \text{ mol NaCl}) \left( \frac{1 \text{ mol Cl}^-}{1 \text{ mol NaCl}} \right) = 0.4534565 \text{ mol Cl}^-$$

**MgCl<sub>2</sub>:**

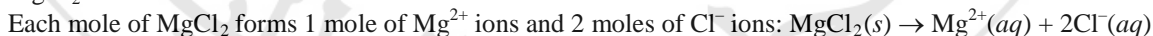

$$\text{Moles of MgCl}_2 = (2.40 \text{ g MgCl}_2) \left( \frac{1 \text{ mol MgCl}_2}{95.21 \text{ g MgCl}_2} \right) = 0.025207 \text{ mol MgCl}_2$$

$$\text{Moles of Mg}^{2+} = (0.025207 \text{ mol MgCl}_2) \left( \frac{1 \text{ mol Mg}^{2+}}{1 \text{ mol MgCl}_2} \right) = 0.025207 \text{ mol Mg}^{2+}$$

$$\text{Moles of Cl}^- = (0.025207 \text{ mol MgCl}_2) \left( \frac{2 \text{ mol Cl}^-}{1 \text{ mol MgCl}_2} \right) = 0.050415 \text{ mol Cl}^-$$

**MgSO<sub>4</sub>:**

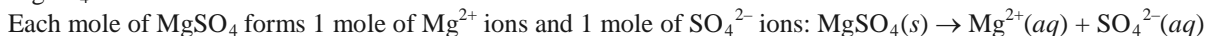



$$\text{Moles of MgSO}_4 = (3.35 \text{ g MgSO}_4) \left( \frac{1 \text{ mol MgSO}_4}{120.38 \text{ g MgSO}_4} \right) = 0.0278285 \text{ mol MgSO}_4$$

$$\text{Moles of Mg}^{2+} = (0.0278285 \text{ mol MgSO}_4) \left( \frac{1 \text{ mol Mg}^{2+}}{1 \text{ mol MgSO}_4} \right) = 0.0278285 \text{ mol Mg}^{2+}$$

$$\text{Moles of SO}_4^{2-} = (0.0278285 \text{ mol MgSO}_4) \left( \frac{1 \text{ mol SO}_4^{2-}}{1 \text{ mol MgSO}_4} \right) = 0.0278285 \text{ mol SO}_4^{2-}$$

CaCl<sub>2</sub>:

Each mole of CaCl<sub>2</sub> forms 1 mole of Ca<sup>2+</sup> ions and 2 moles of Cl<sup>-</sup> ions: CaCl<sub>2</sub>(s) → Ca<sup>2+</sup>(aq) + 2Cl<sup>-</sup>(aq)

$$\text{Moles of CaCl}_2 = (1.20 \text{ g CaCl}_2) \left( \frac{1 \text{ mol CaCl}_2}{110.98 \text{ g CaCl}_2} \right) \left( \frac{1 \text{ mol Ca}^{2+}}{1 \text{ mol CaCl}_2} \right) = 0.0108128 \text{ mol CaCl}_2$$

$$\text{Moles of Ca}^{2+} = (0.0108128 \text{ mol CaCl}_2) \left( \frac{1 \text{ mol Ca}^{2+}}{1 \text{ mol CaCl}_2} \right) = 0.0108128 \text{ mol Ca}^{2+}$$

$$\text{Moles of Cl}^- = (0.0108128 \text{ mol CaCl}_2) \left( \frac{2 \text{ mol Cl}^-}{1 \text{ mol CaCl}_2} \right) = 0.0216255 \text{ mol Cl}^-$$

KCl:

Each mole of KCl forms 1 mole of K<sup>+</sup> ions and 1 mole of Cl<sup>-</sup> ions: KCl(s) → K<sup>+</sup>(aq) + Cl<sup>-</sup>(aq)

$$\text{Moles of KCl} = (1.05 \text{ g KCl}) \left( \frac{1 \text{ mol KCl}}{74.55 \text{ g KCl}} \right) = 0.0140845 \text{ mol KCl}$$

$$\text{Moles of K}^+ = (0.0140845 \text{ mol KCl}) \left( \frac{1 \text{ mol K}^+}{1 \text{ mol KCl}} \right) = 0.0140845 \text{ mol K}^+$$

$$\text{Moles of Cl}^- = (0.0140845 \text{ mol KCl}) \left( \frac{1 \text{ mol Cl}^-}{1 \text{ mol KCl}} \right) = 0.0140845 \text{ mol Cl}^-$$

NaHCO<sub>3</sub>:

Each mole of NaHCO<sub>3</sub> forms 1 mole of Na<sup>+</sup> ions and 1 mole of HCO<sub>3</sub><sup>-</sup> ions: NaHCO<sub>3</sub>(s) → Na<sup>+</sup>(aq) + HCO<sub>3</sub><sup>-</sup>(aq)

$$\text{Moles of NaHCO}_3 = (0.315 \text{ g NaHCO}_3) \left( \frac{1 \text{ mol NaHCO}_3}{84.01 \text{ g NaHCO}_3} \right) = 0.00374955 \text{ mol NaHCO}_3$$

$$\text{Moles of Na}^+ = (0.00374955 \text{ mol NaHCO}_3) \left( \frac{1 \text{ mol Na}^+}{1 \text{ mol NaHCO}_3} \right) = 0.00374955 \text{ mol Na}^+$$

$$\text{Moles of HCO}_3^- = (0.00374955 \text{ mol NaHCO}_3) \left( \frac{1 \text{ mol HCO}_3^-}{1 \text{ mol NaHCO}_3} \right) = 0.00374955 \text{ mol HCO}_3^-$$

NaBr

Each mole of NaBr forms 1 mole of Na<sup>+</sup> ions and 1 mole of Br<sup>-</sup> ions: NaBr(s) → Na<sup>+</sup>(aq) + Br<sup>-</sup>(aq)

$$\text{Moles of NaBr} = (0.098 \text{ g NaBr}) \left( \frac{1 \text{ mol NaBr}}{102.89 \text{ g NaBr}} \right) = 0.0009524735 \text{ mol NaBr}$$

$$\text{Moles of Na}^+ = (0.0009524735 \text{ mol NaBr}) \left( \frac{1 \text{ mol Na}^+}{1 \text{ mol NaBr}} \right) = 0.0009524735 \text{ mol Na}^+$$

$$\text{Moles of Br}^- = (0.0009524735 \text{ mol NaBr}) \left( \frac{1 \text{ mol Br}^-}{1 \text{ mol NaBr}} \right) = 0.0009524735 \text{ mol Br}^-$$

Total moles of each ion:

$$\begin{aligned}\text{Cl}^-: & 0.4534565 + 0.050415 + 0.0216255 + 0.0140845 = 0.5395815 \text{ mol Cl}^- \\ \text{Na}^+: & 0.4534565 + 0.00374955 + 0.0009524735 = 0.458158523 \text{ mol Na}^+ \\ \text{Mg}^{2+}: & 0.025207 + 0.0278285 = 0.0530355 \text{ mol Mg}^{2+} \\ \text{SO}_4^{2-}: & 0.0278285 \text{ mol SO}_4^{2-} \\ \text{Ca}^{2+}: & 0.0108128 \text{ mol Ca}^{2+} \\ \text{K}^+: & 0.0140845 \text{ mol K}^+ \\ \text{HCO}_3^-: & 0.00374955 \text{ mol HCO}_3^- \\ \text{Br}^-: & 0.0009524735 \text{ mol Br}^-\end{aligned}$$

Dividing each of the numbers of moles by the volume (0.97560976 L) and rounding to the proper number of significant figures gives the molarities.

$$M = \frac{\text{mol}}{\text{L}}$$

$$M \text{ Cl}^- = \frac{0.5395815 \text{ mol Cl}^-}{0.97560976 \text{ L}} = 0.55307 = \mathbf{0.553 M \text{ Cl}^-}$$

$$M \text{ Na}^+ = \frac{0.45815823 \text{ mol Na}^+}{0.97560976 \text{ L}} = 0.469612 = \mathbf{0.470 M \text{ Na}^+}$$

$$M \text{ Mg}^{2+} = \frac{0.0530355 \text{ mol Mg}^{2+}}{0.97560976 \text{ L}} = 0.054361 = \mathbf{0.0544 M \text{ Mg}^{2+}}$$

$$M \text{ SO}_4^{2-} = \frac{0.0278285 \text{ mol SO}_4^{2-}}{0.97560976 \text{ L}} = 0.028524 = \mathbf{0.0285 M \text{ SO}_4^{2-}}$$

$$M \text{ Ca}^{2+} = \frac{0.0108128 \text{ mol Ca}^{2+}}{0.97560976 \text{ L}} = 0.011083 = \mathbf{0.0111 M \text{ Ca}^{2+}}$$

$$M \text{ K}^+ = \frac{0.0140845 \text{ mol K}^+}{0.97560976 \text{ L}} = 0.014437 = \mathbf{0.0144 M \text{ K}^+}$$

$$M \text{ HCO}_3^- = \frac{0.00374955 \text{ mol HCO}_3^-}{0.97560976 \text{ L}} = 0.003843 = \mathbf{0.00384 M \text{ HCO}_3^-}$$

$$M \text{ Br}^- = \frac{0.0009524735 \text{ mol Br}^-}{0.97560976 \text{ L}} = 0.0009763 = \mathbf{0.00098 M \text{ Br}^-}$$

b) The alkali metal cations are  $\text{Na}^+$  and  $\text{K}^+$ . Add the molarities of the individual ions.

$$0.469612 M \text{ Na}^+ + 0.014437 M \text{ K}^+ = 0.484049 = \mathbf{0.484 M} \text{ total for alkali metal cations}$$

c) The alkaline earth metal cations are  $\text{Mg}^{2+}$  and  $\text{Ca}^{2+}$ . Add the molarities of the individual ions.

$$0.054361 M \text{ Mg}^{2+} + 0.011083 M \text{ Ca}^{2+} = 0.065444 = \mathbf{0.0654 M} \text{ total for alkaline earth cations}$$

d) The anions are  $\text{Cl}^-$ ,  $\text{SO}_4^{2-}$ ,  $\text{HCO}_3^-$ , and  $\text{Br}^-$ . Add the molarities of the individual ions.

$$0.55307 M \text{ Cl}^- + 0.028524 M \text{ SO}_4^{2-} + 0.003843 M \text{ HCO}_3^- + 0.0009763 M \text{ Br}^- \\ = 0.5864133 = \mathbf{0.586 M} \text{ total for anions}$$

4.19 Plan: Use the molarity and volume of the ions to find the moles of each ion. Multiply the moles of each ion by that ion's charge to find the total moles of charge. Since sodium ions have a +1 charge, the total moles of charge equals the moles of sodium ions.

Solution:

$$\text{Moles of Ca}^{2+} = (1.0 \times 10^3 \text{ L}) \left( \frac{0.015 \text{ mol Ca}^{2+}}{\text{L}} \right) = 15 \text{ mol Ca}^{2+}$$

$$\text{Moles of charge from Ca}^{2+} = (15 \text{ mol Ca}^{2+}) \left( \frac{2 \text{ mol charge}}{1 \text{ mol Ca}^{2+}} \right) = 30. \text{ mol charge from Ca}^{2+}$$

$$\text{Moles of Fe}^{3+} = (1.0 \times 10^3 \text{ L}) \left( \frac{0.0010 \text{ mol Fe}^{3+}}{\text{L}} \right) = 1.0 \text{ mol Fe}^{3+}$$

$$\text{Moles of charge from Fe}^{3+} = \left(1.0 \text{ mol Fe}^{3+}\right) \left(\frac{3 \text{ mol charge}}{1 \text{ mol Fe}^{3+}}\right) = 3.0 \text{ mol charge from Fe}^{3+}$$

Total moles of charge = 30. mol + 3.0 mol = 33 mol charge

$$\text{Moles Na}^+ = (33 \text{ mol charge}) \left(\frac{1 \text{ mol Na}^+}{1 \text{ mol charge}}\right) = \mathbf{33 \text{ mol Na}^+}$$

- 4.20 Plan: Write the total ionic and net ionic equations for the reaction given. The total ionic equation shows all soluble ionic substances dissociated into ions. The net ionic equation eliminates the spectator ions. New equations may be written by replacing the spectator ions in the given equation by other spectator ions.

Solution:

The reaction given has the following total ionic and net ionic equations:

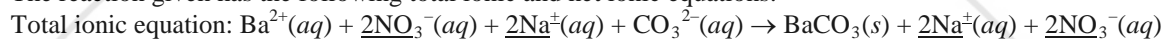

The spectator ions are underlined and are omitted:

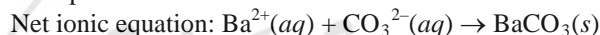

New equations will contain a soluble barium compound and a soluble carbonate compound.

The “new” equations are:

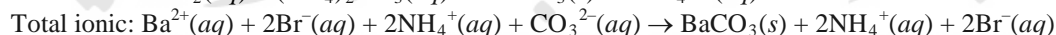
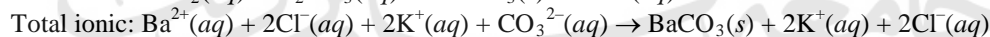

- 4.21 If the electrostatic attraction between the ions is greater than the attraction of the ions for water molecules, the ions will form a precipitate. This is the basis for the solubility rules.

- 4.22 Plan: Write the new cation-anion combinations as the products of the reaction and use the solubility rules to determine if any of the new combinations are insoluble. The spectator ions are the ions that are present in the soluble ionic compound.

Solution:

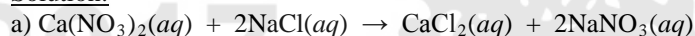

Since the possible products (CaCl<sub>2</sub> and NaNO<sub>3</sub>) are both soluble, no reaction would take place.

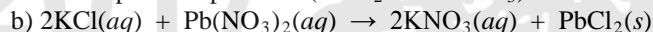

According to the solubility rules, KNO<sub>3</sub> is soluble but PbCl<sub>2</sub> is insoluble so a precipitation reaction takes place. The K<sup>+</sup> and NO<sub>3</sub><sup>-</sup> would be spectator ions, because their salt is soluble.

- 4.23 Plan: Use the solubility rules to predict the products of this reaction. Ions not involved in the precipitate are spectator ions and are not included in the net ionic equation.

Solution:

Assuming that the left beaker is AgNO<sub>3</sub> (because it has gray Ag<sup>+</sup> ions) and the right must be NaCl, then the NO<sub>3</sub><sup>-</sup> is blue, the Na<sup>+</sup> is brown, and the Cl<sup>-</sup> is green. (Cl<sup>-</sup> must be green since it is present with Ag<sup>+</sup> in the precipitate in the beaker on the right.)

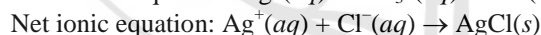
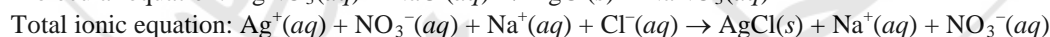
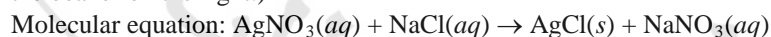

- 4.24 Plan: Write the new cation-anion combinations as the products of the reaction and use the solubility rules to determine if any of the new combinations are insoluble. The total ionic equation shows all soluble ionic substances dissociated into ions. The spectator ions are the ions that are present in the soluble ionic compound. The spectator ions are omitted from the net ionic equation.

Solution:

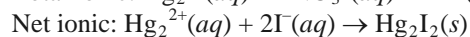
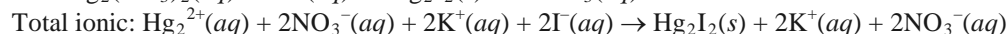

Spectator ions are K<sup>+</sup> and NO<sub>3</sub><sup>-</sup>.

- b) Molecular:  $\text{FeSO}_4(aq) + \text{Sr}(\text{OH})_2(aq) \rightarrow \text{Fe}(\text{OH})_2(s) + \text{SrSO}_4(s)$   
 Total ionic:  $\text{Fe}^{2+}(aq) + \text{SO}_4^{2-}(aq) + \text{Sr}^{2+}(aq) + 2\text{OH}^-(aq) \rightarrow \text{Fe}(\text{OH})_2(s) + \text{SrSO}_4(s)$   
 Net ionic: This is the same as the total ionic equation because there are no spectator ions.
- 4.25 **Plan:** Write the new cation-anion combinations as the products of the reaction and use the solubility rules to determine if any of the new combinations are insoluble. The total ionic equation shows all soluble ionic substances dissociated into ions. The spectator ions are the ions that are present in the soluble ionic compound. The spectator ions are omitted from the net ionic equation.  
**Solution:**  
 a) Molecular:  $3\text{CaCl}_2(aq) + 2\text{Cs}_3\text{PO}_4(aq) \rightarrow \text{Ca}_3(\text{PO}_4)_2(s) + 6\text{CsCl}(aq)$   
 Total ionic:  $3\text{Ca}^{2+}(aq) + 6\text{Cl}^-(aq) + 6\text{Cs}^+(aq) + 2\text{PO}_4^{3-}(aq) \rightarrow \text{Ca}_3(\text{PO}_4)_2(s) + 6\text{Cs}^+(aq) + 6\text{Cl}^-(aq)$   
 Net ionic:  $3\text{Ca}^{2+}(aq) + 2\text{PO}_4^{3-}(aq) \rightarrow \text{Ca}_3(\text{PO}_4)_2(s)$   
 Spectator ions are  $\text{Cs}^+$  and  $\text{Cl}^-$ .  
 b) Molecular:  $\text{Na}_2\text{S}(aq) + \text{ZnSO}_4(aq) \rightarrow \text{ZnS}(s) + \text{Na}_2\text{SO}_4(aq)$   
 Total ionic:  $2\text{Na}^+(aq) + \text{S}^{2-}(aq) + \text{Zn}^{2+}(aq) + \text{SO}_4^{2-}(aq) \rightarrow \text{ZnS}(s) + 2\text{Na}^+(aq) + \text{SO}_4^{2-}(aq)$   
 Net ionic:  $\text{Zn}^{2+}(aq) + \text{S}^{2-}(aq) \rightarrow \text{ZnS}(s)$   
 Spectator ions are  $\text{Na}^+$  and  $\text{SO}_4^{2-}$ .
- 4.26 **Plan:** A precipitate forms if reactant ions can form combinations that are insoluble, as determined by the solubility rules in Table 4.1. Create cation-anion combinations other than the original reactants and determine if they are insoluble. Any ions not involved in a precipitate are spectator ions and are omitted from the net ionic equation.  
**Solution:**  
 a)  $\text{NaNO}_3(aq) + \text{CuSO}_4(aq) \rightarrow \text{Na}_2\text{SO}_4(aq) + \text{Cu}(\text{NO}_3)_2(aq)$   
 No precipitate will form. The ions  $\text{Na}^+$  and  $\text{SO}_4^{2-}$  will not form an insoluble salt according to the first solubility rule which states that all common compounds of Group 1A ions are soluble. The ions  $\text{Cu}^{2+}$  and  $\text{NO}_3^-$  will not form an insoluble salt according to the solubility rule #2: All common nitrates are soluble. There is no reaction.  
 b) A precipitate will form because silver ions,  $\text{Ag}^+$ , and bromide ions,  $\text{Br}^-$ , will combine to form a solid salt, silver bromide,  $\text{AgBr}$ . The ammonium and nitrate ions do not form a precipitate.  
 Molecular:  $\text{NH}_4\text{Br}(aq) + \text{AgNO}_3(aq) \rightarrow \text{AgBr}(s) + \text{NH}_4\text{NO}_3(aq)$   
 Total ionic:  $\text{NH}_4^+(aq) + \text{Br}^-(aq) + \text{Ag}^+(aq) + \text{NO}_3^-(aq) \rightarrow \text{AgBr}(s) + \text{NH}_4^+(aq) + \text{NO}_3^-(aq)$   
 Net ionic:  $\text{Ag}^+(aq) + \text{Br}^-(aq) \rightarrow \text{AgBr}(s)$
- 4.27 **Plan:** A precipitate forms if reactant ions can form combinations that are insoluble, as determined by the solubility rules in Table 4.1. Create cation-anion combinations other than the original reactants and determine if they are insoluble. Any ions not involved in a precipitate are spectator ions and are omitted from the net ionic equation.  
**Solution:**  
 a) Barium carbonate ( $\text{BaCO}_3$ ) precipitates since the solubility rules state that all common carbonates are insoluble.  
 Molecular:  $\text{K}_2\text{CO}_3(aq) + \text{Ba}(\text{OH})_2(aq) \rightarrow \text{BaCO}_3(s) + 2\text{KOH}(aq)$   
 Total ionic:  $2\text{K}^+(aq) + \text{CO}_3^{2-}(aq) + \text{Ba}^{2+}(aq) + 2\text{OH}^-(aq) \rightarrow \text{BaCO}_3(s) + 2\text{K}^+(aq) + 2\text{OH}^-(aq)$   
 Net ionic:  $\text{Ba}^{2+}(aq) + \text{CO}_3^{2-}(aq) \rightarrow \text{BaCO}_3(s)$   
 b) Aluminum phosphate ( $\text{AlPO}_4$ ) precipitates since most common phosphates are insoluble; the sodium nitrate is soluble.  
 Molecular:  $\text{Al}(\text{NO}_3)_3(aq) + \text{Na}_3\text{PO}_4(aq) \rightarrow \text{AlPO}_4(s) + 3\text{NaNO}_3(aq)$   
 Total ionic:  $\text{Al}^{3+}(aq) + 3\text{NO}_3^-(aq) + 3\text{Na}^+(aq) + \text{PO}_4^{3-}(aq) \rightarrow \text{AlPO}_4(s) + 3\text{Na}^+(aq) + 3\text{NO}_3^-(aq)$   
 Net ionic:  $\text{Al}^{3+}(aq) + \text{PO}_4^{3-}(aq) \rightarrow \text{AlPO}_4(s)$
- 4.28 **Plan:** Write a balanced equation for the chemical reaction described in the problem. By applying the solubility rules to the two possible products ( $\text{NaNO}_3$  and  $\text{PbI}_2$ ), determine that  $\text{PbI}_2$  is the precipitate. By using molar relationships, determine how many moles of  $\text{Pb}(\text{NO}_3)_2$  are required to produce 0.628 g of  $\text{PbI}_2$ . The molarity is calculated by dividing moles of  $\text{Pb}(\text{NO}_3)_2$  by its volume in liters.  
**Solution:**  
 The reaction is:  $\text{Pb}(\text{NO}_3)_2(aq) + 2\text{NaI}(aq) \rightarrow \text{PbI}_2(s) + 2\text{NaNO}_3(aq)$ .

$$\text{Moles of Pb(NO}_3)_2 = (0.628 \text{ g PbI}_2) \left( \frac{1 \text{ mol PbI}_2}{461.0 \text{ g PbI}_2} \right) \left( \frac{1 \text{ mol Pb(NO}_3)_2}{1 \text{ mol PbI}_2} \right) = 0.001362256 \text{ mol Pb(NO}_3)_2$$

$$\text{Moles of Pb}^{2+} = \text{moles of Pb(NO}_3)_2 = 0.001362256 \text{ mol Pb}^{2+}$$

$$\text{Molarity of Pb}^{2+} = \frac{\text{moles Pb}^{2+}}{\text{volume of Pb}^{2+}} = \frac{0.001362256 \text{ mol}}{38.5 \text{ mL}} \left( \frac{1 \text{ mL}}{10^{-3} \text{ L}} \right) = 0.035383 = \mathbf{0.0354 \text{ M Pb}^{2+}}$$

- 4.29 Plan: Write a balanced equation for the chemical reaction described in the problem. By applying the solubility rules to the two possible products (KNO<sub>3</sub> and AgCl), determine that AgCl is the precipitate. By using molar relationships, determine how many moles of AgNO<sub>3</sub> are required to produce 0.842 g of AgCl. The molarity is calculated by dividing moles of AgNO<sub>3</sub> by its volume in liters.

Solution:

The reaction is  $\text{AgNO}_3(aq) + \text{KCl}(aq) \rightarrow \text{AgCl}(s) + \text{KNO}_3(aq)$ .

$$\text{Moles of AgNO}_3 = (0.842 \text{ g AgCl}) \left( \frac{1 \text{ mol AgCl}}{143.4 \text{ g AgCl}} \right) \left( \frac{1 \text{ mol AgNO}_3}{1 \text{ mol AgCl}} \right) = 0.0058717 \text{ mol AgNO}_3$$

$$\text{Moles of Ag}^+ = \text{moles of AgNO}_3 = 0.0058717 \text{ mol Ag}^+$$

$$\text{Molarity of Ag}^+ = \frac{\text{moles Ag}^+}{\text{volume of Ag}^+} = \frac{0.0058717 \text{ mol}}{25.0 \text{ mL}} \left( \frac{1 \text{ mL}}{10^{-3} \text{ L}} \right) = 0.2348675 = \mathbf{0.235 \text{ M Ag}^+}$$

- 4.30 Plan: A precipitate forms if reactant ions can form combinations that are insoluble, as determined by the solubility rules in Table 4.1. Create cation-anion combinations other than the original reactants and determine if they are insoluble. Any ions not involved in a precipitate are spectator ions and are omitted from the net ionic equation. Use the molar ratio in the balanced net ionic equation to calculate the mass of product.

Solution:

a) The yellow spheres cannot be ClO<sub>4</sub><sup>-</sup> or NO<sub>3</sub><sup>-</sup> as these ions form only soluble compounds. So the yellow sphere must be SO<sub>4</sub><sup>2-</sup>. The only sulfate compounds possible that would be insoluble are Ag<sub>2</sub>SO<sub>4</sub> and PbSO<sub>4</sub>. The precipitate has a 1:1 ratio between its ions. Ag<sub>2</sub>SO<sub>4</sub> has a 2:1 ratio between its ions. Therefore the blue spheres are Pb<sup>2+</sup> and the yellow spheres are SO<sub>4</sub><sup>2-</sup>. The precipitate is thus **PbSO<sub>4</sub>**.

b) The net ionic equation is  $\text{Pb}^{2+}(aq) + \text{SO}_4^{2-}(aq) \rightarrow \text{PbSO}_4(s)$ .

$$\begin{aligned} \text{c) Mass (g) of PbSO}_4 &= (10 \text{ Pb}^{2+} \text{ spheres}) \left( \frac{5.0 \times 10^{-4} \text{ mol Pb}^{2+}}{1 \text{ Pb}^{2+} \text{ sphere}} \right) \left( \frac{1 \text{ mol PbSO}_4}{1 \text{ mol Pb}^{2+}} \right) \left( \frac{303.3 \text{ g PbSO}_4}{1 \text{ mol PbSO}_4} \right) \\ &= 1.5165 = \mathbf{1.5 \text{ g PbSO}_4} \end{aligned}$$

- 4.31 Plan: A precipitate forms if reactant ions can form combinations that are insoluble, as determined by the solubility rules in Table 4.1. Create cation-anion combinations other than the original reactants and determine if they are insoluble. Any ions not involved in a precipitate are spectator ions and are omitted from the net ionic equation. Use the molar ratio in the balanced net ionic equation to calculate the mass of product.

Solution:

a) There are 9 purple spheres representing cations and 7 green spheres representing anions. In the precipitate, there are 8 purple spheres (cations) and 4 green spheres (anions), indicating a 2:1 ratio between cation and anion in the compound. Only Reaction 3 produces a precipitate (Ag<sub>2</sub>SO<sub>4</sub>) fitting this description:

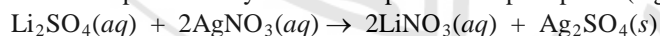

Reaction 1 does not produce a precipitate since all common nitrate and chloride compounds are soluble. Reaction 2 does not produce a precipitate since all common perchlorate and chloride compounds are soluble. Reaction 4 produces a precipitate, PbBr<sub>2</sub>, but it has a cation:anion ratio of 1:2, instead of 2:1.

Total ionic equation for Reaction 3 =

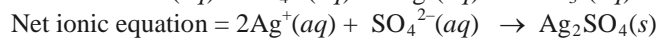
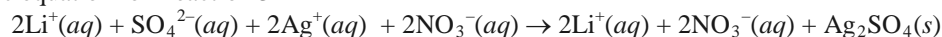

b) There are 4 unreacted spheres of ions.

$$\text{Number of ions} = (4 \text{ spheres}) \left( \frac{2.5 \times 10^{-3} \text{ mol ions}}{1 \text{ sphere}} \right) \left( \frac{6.022 \times 10^{23} \text{ ions}}{1 \text{ mol ions}} \right) = 6.022 \times 10^{21} = \mathbf{6.0 \times 10^{21} \text{ ions}}$$

c) Mass (g) of solid =

$$\begin{aligned} & \left(4 \text{ spheres of } \text{SO}_4^{2-} \text{ ions}\right) \left(\frac{2.5 \times 10^{-3} \text{ mol } \text{SO}_4^{2-} \text{ ions}}{1 \text{ sphere}}\right) \left(\frac{1 \text{ mol } \text{Ag}_2\text{SO}_4}{1 \text{ mol } \text{SO}_4^{2-}}\right) \left(\frac{311.9 \text{ g } \text{Ag}_2\text{SO}_4}{1 \text{ mol } \text{Ag}_2\text{SO}_4}\right) \\ & = 3.119 = \mathbf{3.1 \text{ g solid}} \end{aligned}$$

4.32 Plan: Write a balanced equation for the reaction. Find the moles of  $\text{AgNO}_3$  by multiplying the molarity and volume of the  $\text{AgNO}_3$  solution; use the molar ratio in the balanced equation to find the moles of  $\text{Cl}^-$  present in the 25.00 mL sample. Then, convert moles of  $\text{Cl}^-$  into grams, and convert the sample volume into grams using the given density. The mass percent of  $\text{Cl}^-$  is found by dividing the mass of  $\text{Cl}^-$  by the mass of the sample volume and multiplying by 100.

Solution:

The balanced equation is  $\text{AgNO}_3(aq) + \text{Cl}^-(aq) \rightarrow \text{AgCl}(s) + \text{NO}_3^-(aq)$ .

$$\text{Moles of } \text{AgNO}_3 = (53.63 \text{ mL}) \left(\frac{10^{-3} \text{ L}}{1 \text{ mL}}\right) \left(\frac{0.2970 \text{ mol } \text{AgNO}_3}{\text{L}}\right) = 0.01592811 \text{ mol } \text{AgNO}_3$$

$$\text{Mass (g) of } \text{Cl}^- = (0.01592811 \text{ mol } \text{AgNO}_3) \left(\frac{1 \text{ mol } \text{Cl}^-}{1 \text{ mol } \text{AgNO}_3}\right) \left(\frac{35.45 \text{ g } \text{Cl}}{1 \text{ mol } \text{Cl}^-}\right) = 0.56465 \text{ g } \text{Cl}^-$$

$$\text{Mass (g) of seawater sample} = (25.00 \text{ mL}) \left(\frac{1.024 \text{ g}}{\text{mL}}\right) = 25.60 \text{ g sample}$$

$$\text{Mass \% } \text{Cl}^- = \frac{\text{mass } \text{Cl}^-}{\text{mass sample}} \times 100\% = \frac{0.56465 \text{ g } \text{Cl}^-}{25.60 \text{ g sample}} \times 100\% = 2.20566 = \mathbf{2.206\% \text{ Cl}^-}$$

4.33 Plan: Write the reaction between aluminum sulfate and sodium hydroxide and check the solubility rules to determine the precipitate. Spectator ions are omitted from the net ionic equation. Find the moles of sodium hydroxide by multiplying its molarity by its volume in liters; find the moles of aluminum sulfate by converting grams per liter to moles per liter and multiplying by the volume of that solution. To determine which reactant is limiting, calculate the amount of precipitate formed from each reactant, assuming an excess of the other reactant, using the molar ratio from the balanced equation. The smaller amount of precipitate is the answer.

Solution:

a) According to the solubility rules, most common sulfate compounds are soluble, but most common hydroxides are insoluble. Aluminum hydroxide is the precipitate.

Total ionic equation:  $\text{Al}_2(\text{SO}_4)_3(aq) + 6\text{NaOH}(aq) \rightarrow 3\text{Na}_2\text{SO}_4(aq) + 2\text{Al}(\text{OH})_3(s)$

Net ionic equation:  $\text{Al}^{3+}(aq) + 3\text{OH}^-(aq) \rightarrow \text{Al}(\text{OH})_3(s)$

$$\begin{aligned} \text{b) Moles of } \text{Al}_2(\text{SO}_4)_3 &= (627 \text{ mL}) \left(\frac{10^{-3} \text{ L}}{1 \text{ mL}}\right) \left(\frac{15.8 \text{ g } \text{Al}_2(\text{SO}_4)_3}{\text{L}}\right) \left(\frac{1 \text{ mol } \text{Al}_2(\text{SO}_4)_3}{342.17 \text{ g } \text{Al}_2(\text{SO}_4)_3}\right) \\ &= 0.028952 \text{ mol } \text{Al}_2(\text{SO}_4)_3 \end{aligned}$$

$$\begin{aligned} \text{Mass (g) of } \text{Al}(\text{OH})_3 \text{ from } \text{Al}_2(\text{SO}_4)_3 &= (0.028952 \text{ mol } \text{Al}_2(\text{SO}_4)_3) \left(\frac{2 \text{ mol } \text{Al}(\text{OH})_3}{1 \text{ mol } \text{Al}_2(\text{SO}_4)_3}\right) \left(\frac{78.00 \text{ g } \text{Al}(\text{OH})_3}{1 \text{ mol } \text{Al}(\text{OH})_3}\right) \\ &= 4.5166 \text{ g } \text{Al}(\text{OH})_3 \end{aligned}$$

$$\text{Moles of } \text{NaOH} = (185.5 \text{ mL}) \left(\frac{10^{-3} \text{ L}}{1 \text{ mL}}\right) \left(\frac{0.533 \text{ mol } \text{NaOH}}{\text{L}}\right) = 0.0988715 \text{ mol } \text{NaOH}$$

$$\begin{aligned} \text{Mass (g) of } \text{Al}(\text{OH})_3 \text{ from } \text{NaOH} &= (0.0988715 \text{ mol } \text{NaOH}) \left(\frac{2 \text{ mol } \text{Al}(\text{OH})_3}{6 \text{ mol } \text{NaOH}}\right) \left(\frac{78.00 \text{ g } \text{Al}(\text{OH})_3}{1 \text{ mol } \text{Al}(\text{OH})_3}\right) \\ &= 2.570659 = \mathbf{2.57 \text{ g } \text{Al}(\text{OH})_3} \end{aligned}$$

$\text{NaOH}$  is the limiting reagent.

4.34 Plan: Write the chemical reaction between the two reactants. Then write the total ionic equation in which all soluble ionic substances are dissociated into ions. Omit spectator ions in the net ionic equation.

**Solution:**

The molecular equation is  $\text{H}_2\text{SO}_4(aq) + \text{Sr}(\text{OH})_2(aq) \rightarrow \text{SrSO}_4(s) + 2\text{H}_2\text{O}(l)$

The total ionic equation is:

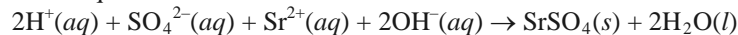

According to the solubility rules,  $\text{SrSO}_4$  is insoluble and therefore does not dissociate into ions.

Since there are no spectator ions, the total and net ionic equations are the same.

4.35 **Plan:** Review the section on acid-base reactions.

**Solution:**

a) Any three of  $\text{HCl}$ ,  $\text{HBr}$ ,  $\text{HI}$ ,  $\text{HNO}_3$ ,  $\text{H}_2\text{SO}_4$ , or  $\text{HClO}_4$

b) Any three of  $\text{NaOH}$ ,  $\text{KOH}$ ,  $\text{Ca}(\text{OH})_2$ ,  $\text{Sr}(\text{OH})_2$ ,  $\text{Ba}(\text{OH})_2$

c) Strong acids and bases dissociate 100% into ions in aqueous solution.

4.36 **Plan:** Review the section on acid-base reactions.

**Solution:**

a) There are many possibilities including: acetic acid ( $\text{HC}_2\text{H}_3\text{O}_2$ ), chlorous acid ( $\text{HClO}_2$ ), and nitrous acid ( $\text{HNO}_2$ ). All acids are weak except for the six strong acids listed in the text.

b)  $\text{NH}_3$

c) Strong acids and bases dissociate 100% into ions and are therefore strong electrolytes; weak acids and bases dissociate much less than this (typically less than 10%) in aqueous solution and are therefore weak electrolytes. The electrical conductivity of a solution of a strong acid or base would be much higher than that of a weak acid or base of equal concentration.

4.37 **Plan:** Since strong acids and bases dissociate completely in water, these substances can be written as ions in a total ionic equation; since weak acids and bases dissociate into ions only to a small extent, these substances appear undissociated in total ionic equations.

**Solution:**

a) Acetic acid is a weak acid and sodium hydroxide is a strong base:

Molecular equation:  $\text{CH}_3\text{COOH}(aq) + \text{NaOH}(aq) \rightarrow \text{CH}_3\text{COONa}(aq) + \text{H}_2\text{O}(l)$

Total ionic equation:  $\text{CH}_3\text{COOH}(aq) + \text{Na}^+(aq) + \text{OH}^-(aq) \rightarrow \text{Na}^+(aq) + \text{CH}_3\text{COO}^-(aq) + \text{H}_2\text{O}(l)$

Net ionic equation (remove the spectator ion  $\text{Na}^+$ ):  $\text{CH}_3\text{COOH}(aq) + \text{OH}^-(aq) \rightarrow \text{CH}_3\text{COO}^-(aq) + \text{H}_2\text{O}(l)$

Hydrochloric acid is a strong acid:

Molecular equation:  $\text{HCl}(aq) + \text{NaOH}(aq) \rightarrow \text{NaCl}(aq) + \text{H}_2\text{O}(l)$

Total ionic equation:  $\text{H}^+(aq) + \text{Cl}^-(aq) + \text{Na}^+(aq) + \text{OH}^-(aq) \rightarrow \text{Na}^+(aq) + \text{Cl}^-(aq) + \text{H}_2\text{O}(l)$

Net ionic equation (remove the spectator ions  $\text{Na}^+$  and  $\text{Cl}^-$ ):  $\text{H}^+(aq) + \text{OH}^-(aq) \rightarrow \text{H}_2\text{O}(l)$

The difference in the net ionic equation is due to the fact that  $\text{CH}_3\text{COOH}$  is a weak acid and dissociates very little while  $\text{HCl}$  is a strong acid and dissociates completely.

b) When acetic acid dissociates in water, most of the species in the solution is un-ionized acid,  $\text{CH}_3\text{COOH}(aq)$ ; the amounts of its ions,  $\text{H}^+$  and  $\text{CH}_3\text{COO}^-$ , are equal but very small:  $[\text{CH}_3\text{COOH}] \gg [\text{H}^+] = [\text{CH}_3\text{COO}^-]$ .

4.38 **Plan:** Remember that strong acids and bases can be written as ions in the total ionic equation but weak acids and bases cannot be written as ions. Omit spectator ions from the net ionic equation.

**Solution:**

a)  $\text{KOH}$  is a strong base and  $\text{HBr}$  is a strong acid; both may be written in dissociated form.  $\text{KBr}$  is a soluble compound since all Group 1A(1) compounds are soluble.

Molecular equation:  $\text{KOH}(aq) + \text{HBr}(aq) \rightarrow \text{KBr}(aq) + \text{H}_2\text{O}(l)$

Total ionic equation:  $\text{K}^+(aq) + \text{OH}^-(aq) + \text{H}^+(aq) + \text{Br}^-(aq) \rightarrow \text{K}^+(aq) + \text{Br}^-(aq) + \text{H}_2\text{O}(l)$

Net ionic equation:  $\text{OH}^-(aq) + \text{H}^+(aq) \rightarrow \text{H}_2\text{O}(l)$

The spectator ions are  $\text{K}^+(aq)$  and  $\text{Br}^-(aq)$ .

b)  $\text{NH}_3$  is a weak base and is written in the molecular form.  $\text{HCl}$  is a strong acid and is written in the dissociated form (as ions).  $\text{NH}_4\text{Cl}$  is a soluble compound, because all ammonium compounds are soluble.

Molecular equation:  $\text{NH}_3(aq) + \text{HCl}(aq) \rightarrow \text{NH}_4\text{Cl}(aq)$

Total ionic equation:  $\text{NH}_3(aq) + \text{H}^+(aq) + \text{Cl}^-(aq) \rightarrow \text{NH}_4^+(aq) + \text{Cl}^-(aq)$

Net ionic equation:  $\text{NH}_3(aq) + \text{H}^+(aq) \rightarrow \text{NH}_4^+(aq)$

$\text{Cl}^-$  is the only spectator ion.

- 4.39 Plan: Remember that strong acids and bases can be written as ions in the total ionic equation but weak acids and bases cannot be written as ions. Omit spectator ions from the net ionic equation.  
Solution:  
 a) CsOH is a strong base and HNO<sub>3</sub> is a strong acid; both may be written in dissociated form. CsNO<sub>3</sub> is a soluble compound since all nitrate compounds are soluble.  
 Molecular equation:  $\text{CsOH}(aq) + \text{HNO}_3(aq) \rightarrow \text{CsNO}_3(aq) + \text{H}_2\text{O}(l)$   
 Total ionic equation:  $\text{Cs}^+(aq) + \text{OH}^-(aq) + \text{H}^+(aq) + \text{NO}_3^-(aq) \rightarrow \text{Cs}^+(aq) + \text{NO}_3^-(aq) + \text{H}_2\text{O}(l)$   
 Net ionic equation:  $\text{OH}^-(aq) + \text{H}^+(aq) \rightarrow \text{H}_2\text{O}(l)$   
 Spectator ions are Cs<sup>+</sup> and NO<sub>3</sub><sup>-</sup>.  
 b) HC<sub>2</sub>H<sub>3</sub>O<sub>2</sub> is a weak acid and is written in the molecular form. Ca(OH)<sub>2</sub> is a strong base and is written in the dissociated form (as ions). Ca(C<sub>2</sub>H<sub>3</sub>O<sub>2</sub>)<sub>2</sub> is a soluble compound, because all acetate compounds are soluble.  
 Molecular equation:  $\text{Ca}(\text{OH})_2(aq) + 2\text{HC}_2\text{H}_3\text{O}_2(aq) \rightarrow \text{Ca}(\text{C}_2\text{H}_3\text{O}_2)_2(aq) + 2\text{H}_2\text{O}(l)$   
 Total ionic equation:  $\text{Ca}^{2+}(aq) + 2\text{OH}^-(aq) + 2\text{HC}_2\text{H}_3\text{O}_2(aq) \rightarrow \text{Ca}^{2+}(aq) + 2\text{C}_2\text{H}_3\text{O}_2^-(aq) + 2\text{H}_2\text{O}(l)$   
 Net ionic equation:  $\text{OH}^-(aq) + \text{HC}_2\text{H}_3\text{O}_2(aq) \rightarrow \text{C}_2\text{H}_3\text{O}_2^-(aq) + \text{H}_2\text{O}(l)$   
 Spectator ion is Ca<sup>2+</sup>.
- 4.40 Plan: Write an acid-base reaction between CaCO<sub>3</sub> and HCl. Remember that HCl is a strong acid.  
Solution:  
 Calcium carbonate dissolves in HCl(aq) because the carbonate ion, a base, reacts with the acid to form H<sub>2</sub>CO<sub>3</sub> which decomposes into CO<sub>2</sub>(g) and H<sub>2</sub>O(l).  
 $\text{CaCO}_3(s) + 2\text{HCl}(aq) \rightarrow \text{CaCl}_2(aq) + \text{H}_2\text{CO}_3(aq)$   
 Total ionic equation:  
 $\text{CaCO}_3(s) + 2\text{H}^+(aq) + 2\text{Cl}^-(aq) \rightarrow \text{Ca}^{2+}(aq) + 2\text{Cl}^-(aq) + \text{H}_2\text{O}(l) + \text{CO}_2(g)$   
 Net ionic equation:  
 $\text{CaCO}_3(s) + 2\text{H}^+(aq) \rightarrow \text{Ca}^{2+}(aq) + \text{H}_2\text{O}(l) + \text{CO}_2(g)$
- 4.41 Plan: Write an acid-base reaction between Zn(OH)<sub>2</sub> and HNO<sub>3</sub>. Remember that HNO<sub>3</sub> is a strong acid.  
Solution:  
 Zinc hydroxide dissolves in HCl(aq) because the hydroxide ion, a base, reacts with the acid to form soluble zinc nitrate and water.  
 $\text{Zn}(\text{OH})_2(s) + 2\text{HNO}_3(aq) \rightarrow \text{Zn}(\text{NO}_3)_2(aq) + 2\text{H}_2\text{O}(aq)$   
 Total ionic equation:  
 $\text{Zn}(\text{OH})_2(s) + 2\text{H}^+(aq) + 2\text{NO}_3^-(aq) \rightarrow \text{Zn}^{2+}(aq) + 2\text{NO}_3^-(aq) + 2\text{H}_2\text{O}(l)$   
 Net ionic equation:  
 $\text{Zn}(\text{OH})_2(s) + 2\text{H}^+(aq) \rightarrow \text{Zn}^{2+}(aq) + 2\text{H}_2\text{O}(l)$
- 4.42 Plan: Write a balanced equation. Find the moles of KOH from the molarity and volume information and use the molar ratio in the balanced equation to find the moles of acid present. Divide the moles of acid by its volume to determine the molarity.  
Solution:  
 The reaction is:  $\text{KOH}(aq) + \text{CH}_3\text{COOH}(aq) \rightarrow \text{CH}_3\text{COOK}(aq) + \text{H}_2\text{O}(l)$   
 Moles of KOH =  $(25.98 \text{ mL}) \left( \frac{10^{-3} \text{ L}}{1 \text{ mL}} \right) \left( \frac{0.1180 \text{ mol KOH}}{\text{L}} \right) = 0.00306564 \text{ mol KOH}$   
 Moles of CH<sub>3</sub>COOH =  $(0.00306564 \text{ mol KOH}) \left( \frac{1 \text{ mol CH}_3\text{COOH}}{1 \text{ mol KOH}} \right) = 0.00306564 \text{ mol CH}_3\text{COOH}$   
 Molarity of CH<sub>3</sub>COOH =  $\left( \frac{0.00306564 \text{ mol CH}_3\text{COOH}}{52.50 \text{ mL}} \right) \left( \frac{1 \text{ mL}}{10^{-3} \text{ L}} \right) = 0.05839314 = \mathbf{0.05839 \text{ M CH}_3\text{COOH}}$
- 4.43 Plan: Write a balanced equation. Find the moles of NaOH from the molarity and volume information and use the molar ratio in the balanced equation to find the moles of acid present. Divide the moles of acid by its volume to determine the molarity.



Solution:

The reaction is:  $2\text{NaOH}(aq) + \text{H}_2\text{SO}_4(aq) \rightarrow \text{Na}_2\text{SO}_4(aq) + 2\text{H}_2\text{O}(l)$

$$\text{Moles of NaOH} = (26.25 \text{ mL}) \left( \frac{10^{-3} \text{ L}}{1 \text{ mL}} \right) \left( \frac{0.1850 \text{ mol NaOH}}{\text{L}} \right) = 0.00485625 \text{ mol NaOH}$$

$$\text{Moles of H}_2\text{SO}_4 = (0.00485625 \text{ mol NaOH}) \left( \frac{1 \text{ mol H}_2\text{SO}_4}{2 \text{ mol NaOH}} \right) = 0.002428125 \text{ mol H}_2\text{SO}_4$$

$$\text{Molarity of H}_2\text{SO}_4 = \left( \frac{0.002428125 \text{ mol H}_2\text{SO}_4}{25.00 \text{ mL}} \right) \left( \frac{1 \text{ mL}}{10^{-3} \text{ L}} \right) = 0.097125 = \mathbf{0.09712 \text{ M H}_2\text{SO}_4}$$

- 4.44 Plan: Write a balanced equation. Find the moles of  $\text{H}_2\text{SO}_4$  from the molarity and volume information and use the molar ratio in the balanced equation to find the moles of  $\text{NaHCO}_3$  required to react with that amount of  $\text{H}_2\text{SO}_4$ . Divide the moles of  $\text{NaHCO}_3$  by its molarity to find the volume.

Solution:

The reaction is:  $2\text{NaHCO}_3(aq) + \text{H}_2\text{SO}_4(aq) \rightarrow \text{Na}_2\text{SO}_4(aq) + 2 \text{H}_2\text{O}(l) + 2\text{CO}_2(g)$

$$\text{Moles of H}_2\text{SO}_4 = (88 \text{ mL}) \left( \frac{10^{-3} \text{ L}}{1 \text{ mL}} \right) \left( \frac{2.6 \text{ mol H}_2\text{SO}_4}{\text{L}} \right) = 0.2288 \text{ mol H}_2\text{SO}_4$$

$$\text{Moles of NaHCO}_3 = (0.2288 \text{ mol H}_2\text{SO}_4) \left( \frac{2 \text{ mol NaHCO}_3}{1 \text{ mol H}_2\text{SO}_4} \right) = 0.4576 \text{ mol NaHCO}_3$$

$$\begin{aligned} \text{Volume (mL) of NaHCO}_3 &= (0.4576 \text{ mol NaHCO}_3) \left( \frac{1 \text{ L}}{1.6 \text{ mol NaHCO}_3} \right) \left( \frac{1 \text{ mL}}{10^{-3} \text{ L}} \right) \\ &= 286 = \mathbf{2.9 \times 10^2 \text{ mL NaHCO}_3} \end{aligned}$$

- 4.45 Plan: Balance the reaction. Convert the amount of  $\text{UO}_2$  from kg to g to moles; use the molar ratio in the balanced reaction to find the moles of HF required to react with the moles of  $\text{UO}_2$ . Divide moles of HF by its molarity to calculate the volume.

Solution:

The reaction is:  $\text{UO}_2(s) + 4\text{HF}(aq) \rightarrow \text{UF}_4(s) + 2\text{H}_2\text{O}(l)$

$$\text{Moles of UO}_2 = (2.15 \text{ kg UO}_2) \left( \frac{10^3 \text{ g}}{1 \text{ kg}} \right) \left( \frac{1 \text{ mol UO}_2}{270.0 \text{ g UO}_2} \right) = 7.96296 \text{ mol UO}_2$$

$$\text{Moles of HF} = (7.96296 \text{ mol UO}_2) \left( \frac{4 \text{ mol HF}}{1 \text{ mol UO}_2} \right) = 31.85184 \text{ mol HF}$$

$$\text{Volume (L) of HF} = (31.85184 \text{ mol HF}) \left( \frac{1 \text{ L}}{2.40 \text{ mol HF}} \right) = 13.2716 = \mathbf{13.3 \text{ L HF}}$$

- 4.46 Plan: Write balanced equations for the reaction of NaOH with oxalic acid, benzoic acid, and HCl. Find the moles of added NaOH from the molarity and volume information; then use the molarity and volume information for HCl to find the moles of HCl required to react with the excess NaOH. Use the molar ratio in the NaOH/HCl reaction to find the moles of excess NaOH. The moles of NaOH required to titrate the acid samples is the difference of the added NaOH and the excess NaOH. Let  $x$  = mass of benzoic acid and  $0.3471 - x$  = mass of oxalic acid. Convert the mass of each acid to moles using the molar mass and use the molar ratios in the balanced reactions to find the amounts of each acid. Mass percent is calculated by dividing the mass of benzoic acid by the mass of the sample and multiplying by 100.

Solution:

Oxalic acid is  $\text{H}_2\text{C}_2\text{O}_4$  and benzoic acid is  $\text{HC}_7\text{H}_5\text{O}_2$ .

The reactions are:  $\text{NaOH}(aq) + \text{HCl}(aq) \rightarrow \text{NaCl}(aq) + \text{H}_2\text{O}(l)$

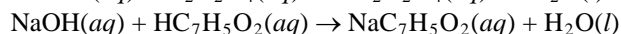
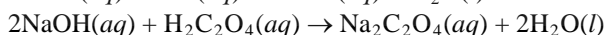

$$\text{Moles of NaOH added} = (100.0 \text{ mL}) \left( \frac{10^{-3} \text{ L}}{1 \text{ mL}} \right) \left( \frac{0.1000 \text{ mol NaOH}}{1 \text{ L}} \right) = 0.01000 \text{ mol NaOH}$$

$$\text{Moles of added HCl} = (20.00 \text{ mL}) \left( \frac{10^{-3} \text{ L}}{1 \text{ mL}} \right) \left( \frac{0.2000 \text{ mol HCl}}{1 \text{ L}} \right) = 0.004000 \text{ mol HCl}$$

$$\text{Moles of excess NaOH} = (0.004000 \text{ mol HCl}) \left( \frac{1 \text{ mol NaOH}}{1 \text{ mol HCl}} \right) = 0.004000 \text{ mol NaOH}$$

$$\begin{aligned} \text{Moles of NaOH required to titrate sample} &= \text{moles NaOH added} - \text{moles excess NaOH} \\ &= 0.01000 \text{ mol} - 0.004000 \text{ mol} = 0.006000 \text{ mol NaOH} \end{aligned}$$

Let  $x$  = mass of  $\text{HC}_7\text{H}_5\text{O}_2$  and  $0.3471 - x$  = mass of  $\text{H}_2\text{C}_2\text{O}_4$

Moles of NaOH required to titrate  $\text{HC}_7\text{H}_5\text{O}_2$  =

$$(x \text{ g HC}_7\text{H}_5\text{O}_2) \left( \frac{1 \text{ mol HC}_7\text{H}_5\text{O}_2}{122.12 \text{ g HC}_7\text{H}_5\text{O}_2} \right) \left( \frac{1 \text{ mol NaOH}}{1 \text{ mol HC}_7\text{H}_5\text{O}_2} \right) = 0.008189x$$

$$\begin{aligned} \text{Moles of NaOH required to titrate H}_2\text{C}_2\text{O}_4 &= ((0.3471 - x) \text{ g H}_2\text{C}_2\text{O}_4) \left( \frac{1 \text{ mol H}_2\text{C}_2\text{O}_4}{90.04 \text{ g H}_2\text{C}_2\text{O}_4} \right) \left( \frac{2 \text{ mol NaOH}}{1 \text{ mol H}_2\text{C}_2\text{O}_4} \right) \\ &= 0.007710 - 0.02221x \end{aligned}$$

$$\begin{aligned} \text{Moles of NaOH required to titrate sample} &= 0.006000 \text{ mol} = 0.008189x + (0.007710 - 0.02221x) \\ 0.006000 &= 0.007710 - 0.014021x \\ -0.001710 &= -0.014021x \\ 0.12196 &= x = \text{mass of HC}_7\text{H}_5\text{O}_2 \end{aligned}$$

$$\text{Mass \% of HC}_7\text{H}_5\text{O}_2 = \frac{\text{mass of HC}_7\text{H}_5\text{O}_2}{\text{mass of sample}} (100) = \frac{0.12196 \text{ g}}{0.3471 \text{ g}} (100) = 35.1368 = \mathbf{35.14\%}$$

- 4.47 Plan: Write balanced reactions between  $\text{HNO}_3$  and each of the bases. Find the moles of  $\text{HNO}_3$  from its molarity and volume. Let  $x$  = mass of  $\text{Al}(\text{OH})_3$  and  $0.4826 - x$  = mass of  $\text{Mg}(\text{OH})_2$ . Convert the mass of each base to moles using the molar mass and use the molar ratios in the balanced reactions to find the amounts of each base. Mass percent is calculated by dividing the mass of  $\text{Al}(\text{OH})_3$  by the mass of the sample and multiplying by 100.

Solution:

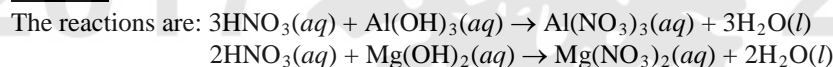

$$\text{Moles of HNO}_3 = (17.30 \text{ mL}) \left( \frac{10^{-3} \text{ L}}{1 \text{ mL}} \right) \left( \frac{1.000 \text{ mol HNO}_3}{1 \text{ L}} \right) = 0.0173 \text{ mol HNO}_3$$

Let  $x$  = mass of  $\text{Al}(\text{OH})_3$  and  $0.4826 - x$  = mass of  $\text{Mg}(\text{OH})_2$

Moles of  $\text{HNO}_3$  required to titrate  $\text{Al}(\text{OH})_3$  =

$$(x \text{ g Al}(\text{OH})_3) \left( \frac{1 \text{ mol Al}(\text{OH})_3}{78.00 \text{ g Al}(\text{OH})_3} \right) \left( \frac{3 \text{ mol HNO}_3}{1 \text{ mol Al}(\text{OH})_3} \right) = 0.038462x$$

Moles of  $\text{HNO}_3$  required to titrate  $\text{Mg}(\text{OH})_2$  =

$$\begin{aligned} ((0.4826 - x) \text{ g Mg}(\text{OH})_2) \left( \frac{1 \text{ mol Mg}(\text{OH})_2}{58.33 \text{ g Mg}(\text{OH})_2} \right) \left( \frac{2 \text{ mol HNO}_3}{1 \text{ mol Mg}(\text{OH})_2} \right) \\ = 0.01655 - 0.03429x \end{aligned}$$

$$\begin{aligned} \text{Moles of HNO}_3 \text{ required to titrate sample} &= 0.0173 \text{ mol} = 0.038462x + (0.01655 - 0.03429x) \\ 0.0173 &= 0.004172x + 0.01655 \\ 0.17977 \text{ g} &= x = \text{mass of Al}(\text{OH})_3 \end{aligned}$$

$$\text{Mass \% of Al}(\text{OH})_3 = \frac{\text{mass of Al}(\text{OH})_3}{\text{mass of sample}} (100) = \frac{0.17977 \text{ g}}{0.4826 \text{ g}} (100) = 37.2503 = \mathbf{37.25\%}$$

- 4.48 Plan: Recall that oxidation is the loss of electrons and reduction is the gain of electrons.  
Solution:  
 The electrons that a substance gains during reduction must come from somewhere. So there must be an oxidation in which electrons are lost, to provide the electrons gained during reduction.
- 4.49 Plan: An oxidizing agent gains electrons and therefore has an atom whose oxidation number decreases during the reaction. Use the Rules for Assigning an Oxidation Number to assign S in  $\text{H}_2\text{SO}_4$  an O.N. and see if this oxidation number changes during the reaction. An acid transfers a proton during reaction.  
Solution:  
 a) In  $\text{H}_2\text{SO}_4$ , hydrogen has an O.N. of +1, for a total of +2; oxygen has an O.N. of -2 for a total of -8. The S has an O.N. of +6. In  $\text{SO}_2$ , the O.N. of oxygen is -2 for a total of -4 and S has an O.N. of +4. So the S has been reduced from +6 to +4 and is an **oxidizing agent**. Iodine is oxidized during the reaction.  
 b) The oxidation number of S is +6 in  $\text{H}_2\text{SO}_4$ ; in  $\text{BaSO}_4$ , Ba has an O.N. of +2, the four oxygen atoms have a total O.N. of -8, and S is again +6. Since the oxidation number of S (or any of the other atoms) did not change, this is not a redox reaction.  $\text{H}_2\text{SO}_4$  transfers a proton to  $\text{F}^-$  to produce HF, so it acts as an **acid**.
- 4.50 Plan: Consult the Rules for Assigning an Oxidation Number. The sum of the O.N. values for the atoms in a molecule equals zero, while the sum of the O.N. values for the atoms in an ion equals the ion's charge.  
Solution:  
 a)  $\text{NH}_2\text{OH}$ . Hydrogen has an O.N. of +1, for a total of +3 for the three hydrogen atoms. Oxygen has an O.N. of -2. The O.N. of N must be -1 since  $[(-1) + (+3) + (-2)] = 0$ . **N = -1**  
 b)  $\text{N}_2\text{F}_4$ . The O.N. of each fluorine is -1 for a total of -4; the sum of the O.N.s for the two N atoms must be +4, so each N has an O.N. of +2. **N = +2**  
 c)  $\text{NH}_4^+$ . The O.N. of each hydrogen is +1 for a total of +4; the O.N. of nitrogen must be -3 since the overall sum of the O.N.s must be +1:  $[(-3) + (+4)] = +1$  **N = -3**  
 d)  $\text{HNO}_2$ . The O.N. of hydrogen is +1 and that of each oxygen is -2 for a total of -4 from the oxygens. The O.N. of nitrogen must be +3 since  $[(+1) + (+3) + (-4)] = 0$ . **N = +3**
- 4.51 Plan: Consult the Rules for Assigning an Oxidation Number. The sum of the O.N. values for the atoms in a molecule equals zero.  
Solution:  
 a)  $\text{SOCl}_2$ . The O.N. of oxygen is -2 and that of each chlorine is -1 for a total of -2 for the two chlorine atoms. The O.N. of sulfur must be +4 since  $[(+4) + (-2) + (-2)] = 0$ . **S = +4**  
 b)  $\text{H}_2\text{S}_2$ . The O.N. of each hydrogen is +1, for a total of +2. The sum of the O.N.s of the two sulfur atoms must equal -2, so the O.N. of each S atom is -1. **S = -1**  
 c)  $\text{H}_2\text{SO}_3$ . The O.N. of each hydrogen atom is +1 for a total of +2; the O.N. of each oxygen atom is -2 for a total of -6. The O.N. of the sulfur must be +4 since  $[(+2) + (+4) + (-6)] = 0$ . **S = +4**  
 d)  $\text{Na}_2\text{S}$ . The O.N. of each sodium [Group 1A(1)] is +1, for a total of +2. The O.N. of sulfur is -2. **S = -2**
- 4.52 Plan: Consult the Rules for Assigning an Oxidation Number. The sum of the O.N. values for the atoms in a molecule equals zero, while the sum of the O.N. values for the atoms in an ion equals the ion's charge.  
Solution:  
 a)  $\text{AsH}_3$ . H is combined with a nonmetal, so its O.N. is +1 (Rule 3). Three H atoms have a sum of +3. To have a sum of 0 for the molecule, As has an O.N. of -3. **As = -3**  
 b)  $\text{H}_2\text{AsO}_4^-$ . The O.N. of H in this compound is +1, for a total of +2. The O.N. of each oxygen is -2, for a total of -8. As has an O.N. of +5 since  $[(+2) + (+5) + (-8)] = -1$ , the charge of the ion. **As = +5**  
 c)  $\text{AsCl}_3$ . Each chlorine has an O.N. of -1, for a total of -3. The O.N. of As is +3. **As = +3**
- 4.53 Plan: Consult the Rules for Assigning an Oxidation Number. The sum of the O.N. values for the atoms in a molecule equals zero, while the sum of the O.N. values for the atoms in an ion equals the ion's charge.  
Solution:  
 a)  $\text{H}_2\text{P}_2\text{O}_7^{2-}$ . The O.N. of each hydrogen is +1, for a total of +2; the O.N. of each oxygen is -2, for a total of -14. The sum of the O.N.s of the two phosphorus atoms must be +10 since  $[(+2) + (+10) + (-14)] = -2$ , the charge of the ion. Each of the two phosphorus atoms has an O.N. of +5. **P = +5**  
 b)  $\text{PH}_4^+$ . The O.N. of each hydrogen is +1, for a total of +4. The O.N. of P is -3 since  $[(-3) + (+4)] = +1$ , the charge of the ion. **P = -3**

- c)  $\text{PCl}_5$ . The O.N. of each Cl is  $-1$ , for a total of  $-5$ . The O.N. of P is therefore  $+5$ . **P = +5**
- 4.54 **Plan:** Consult the Rules for Assigning an Oxidation Number. The sum of the O.N. values for the atoms in a molecule equals zero, while the sum of the O.N. values for the atoms in an ion equals the ion's charge.  
**Solution:**  
a)  $\text{MnO}_4^{2-}$ . The O.N. of each oxygen is  $-2$ , for a total of  $-8$ ; the O.N. of Mn must be  $+6$  since  $[(+6) + (-8)] = -2$ , the charge of the ion. **Mn = +6**  
b)  $\text{Mn}_2\text{O}_3$ . The O.N. of each oxygen is  $-2$ , for a total of  $-6$ ; the sum of the O.N.s of the two Mn atoms must be  $+6$ . The O.N. of each manganese is  $+3$ . **Mn = +3**  
c)  $\text{KMnO}_4$ . The O.N. of potassium is  $+1$  and the O.N. of each oxygen is  $-2$ , for a total of  $-8$ . The O.N. of Mn is  $+7$  since  $[(+1) + (+7) + (-8)] = 0$ . **Mn = +7**
- 4.55 **Plan:** Consult the Rules for Assigning an Oxidation Number. The sum of the O.N. values for the atoms in a molecule equals zero, while the sum of the O.N. values for the atoms in an ion equals the ion's charge.  
**Solution:**  
a)  $\text{CrO}_3$ . The O.N. of each oxygen atom is  $-2$ , for a total of  $-6$ . The O.N. of chromium must be  $+6$ . **Cr = +6**  
b)  $\text{Cr}_2\text{O}_7^{2-}$ . The O.N. of each oxygen is  $-2$ , for a total of  $-14$ . The sum of the O.N.s of the two chromium atoms must be  $+12$  since  $[(+12) + (-14)] = -2$ , the charge of the ion. Each of the two chromium atoms has an O.N. of  $+6$ . **Cr = +6**  
c)  $\text{Cr}_2(\text{SO}_4)_3$ . It is convenient to treat the polyatomic ion  $\text{SO}_4^{2-}$  as a unit with a  $-2$  charge, for a total of  $-6$  for the three sulfate ions. The sum of the two chromium atoms must be  $+6$  and the O.N. of each chromium atom is  $+3$ . **Cr = +3**
- 4.56 **Plan:** First, assign oxidation numbers to all atoms following the rules. The reactant that is the reducing agent contains an atom that is oxidized (O.N. increases from the left side to the right side of the equation). The reactant that is the oxidizing agent contains an atom that is reduced (O.N. decreases from the left side to the right side of the equation). Recognize that the agent is the compound that contains the atom that is oxidized or reduced, not just the atom itself.  
**Solution:**  
a) 
$$\begin{array}{cccccccccccc} +2 & +6 & -8 & & -8 & & & -4 & +2 & & & \\ +1 & +3 & -2 & & +7 & -2 & +1 & +2 & +4 & -2 & +1 & -2 \\ \hline 5\text{H}_2\text{C}_2\text{O}_4(\text{aq}) & + & 2\text{MnO}_4^-(\text{aq}) & + & 6\text{H}^+(\text{aq}) & \rightarrow & 2\text{Mn}^{2+}(\text{aq}) & + & 10\text{CO}_2(\text{g}) & + & 8\text{H}_2\text{O}(\text{l}) \end{array}$$
Mn in  $\text{MnO}_4^-$  changes from  $+7$  to  $+2$  (reduction). Therefore,  **$\text{MnO}_4^-$  is the oxidizing agent.** C in  $\text{H}_2\text{C}_2\text{O}_4$  changes from  $+3$  to  $+4$  (oxidation), so  **$\text{H}_2\text{C}_2\text{O}_4$  is the reducing agent.**  
b) 
$$\begin{array}{cccccccccccc} & & & & -6 & & & +2 & & & & \\ 0 & +1 & +5 & -2 & +2 & +2 & -2 & +1 & -2 & & & \\ \hline 3\text{Cu}(\text{s}) & + & 8\text{H}^+(\text{aq}) & + & 2\text{NO}_3^-(\text{aq}) & \rightarrow & 3\text{Cu}^{2+}(\text{aq}) & + & 2\text{NO}(\text{g}) & + & 4\text{H}_2\text{O}(\text{l}) \end{array}$$
Cu changes from  $0$  to  $+2$  (is oxidized) and **Cu is the reducing agent.** N changes from  $+5$  (in  $\text{NO}_3^-$ ) to  $+2$  (in  $\text{NO}$ ) and is reduced, so  **$\text{NO}_3^-$  is the oxidizing agent.**
- 4.57 **Plan:** First, assign oxidation numbers to all atoms following the rules. The reactant that is the reducing agent contains an atom that is oxidized (O.N. increases from the left side to the right side of the equation). The reactant that is the oxidizing agent contains an atom that is reduced (O.N. decreases from the left side to the right side of the equation). Recognize that the agent is the compound that contains the atom that is oxidized or reduced, not just the atom itself.  
**Solution:**  

$$\begin{array}{cccc} 0 & +1 & +2 & 0 \\ \hline \text{Sn}(\text{s}) & + & 2\text{H}^+(\text{aq}) & \rightarrow & \text{Sn}^{2+}(\text{aq}) & + & \text{H}_2(\text{g}) \end{array}$$
Sn changes from  $0$  to  $+2$  (is oxidized) so **Sn is the reducing agent.** H changes from  $+1$  to  $0$  (is reduced) so  **$\text{H}^+$  is the oxidizing agent.**  
b) 
$$\begin{array}{cccccccc} +2 & -2 & & & & & +2 & \\ +1 & +1 & -1 & +2 & +3 & +1 & -2 & \\ \hline 2\text{H}^+(\text{aq}) & + & \text{H}_2\text{O}_2(\text{aq}) & + & 2\text{Fe}^{2+}(\text{aq}) & \rightarrow & 2\text{Fe}^{3+}(\text{aq}) & + & 2\text{H}_2\text{O}(\text{l}) \end{array}$$
Oxygen changes from  $-1$  in  $\text{H}_2\text{O}_2$  to  $-2$  in  $\text{H}_2\text{O}$  (is reduced) so  **$\text{H}_2\text{O}_2$  is the oxidizing agent.** Fe changes from  $+2$  to  $+3$  (is oxidized) so  **$\text{Fe}^{2+}$  is the reducing agent.**

- 4.58 **Plan:** First, assign oxidation numbers to all atoms following the rules. The reactant that is the reducing agent contains an atom that is oxidized (O.N. increases from the left side to the right side of the equation). The reactant that is the oxidizing agent contains an atom that is reduced (O.N. decreases from the left side to the right side of the equation). Recognize that the agent is the compound that contains the atom that is oxidized or reduced, not just the atom itself.

**Solution:**

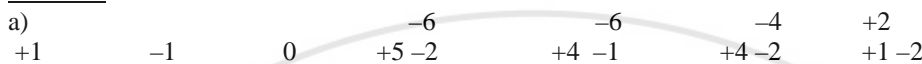

Nitrogen changes from an O.N. of +5 in  $\text{NO}_3^-$  to +4 in  $\text{NO}_2$  (is reduced) so  $\text{NO}_3^-$  is the oxidizing agent. Sn changes from an O.N. of 0 to an O.N. of +4 in  $\text{SnCl}_6^{2-}$  (is oxidized) so Sn is the reducing agent.



Manganese changes from an O.N. of +7 in  $\text{MnO}_4^-$  to an O.N. of +2 in  $\text{Mn}^{2+}$  (is reduced) so  $\text{MnO}_4^-$  is the oxidizing agent. Chlorine changes its O.N. from -1 in  $\text{Cl}^-$  to 0 as the element  $\text{Cl}_2$  (is oxidized) so  $\text{Cl}^-$  is the reducing agent.

- 4.59 **Plan:** First, assign oxidation numbers to all atoms following the rules. The reactant that is the reducing agent contains an atom that is oxidized (O.N. increases from the left side to the right side of the equation). The reactant that is the oxidizing agent contains an atom that is reduced (O.N. decreases from the left side to the right side of the equation). Recognize that the agent is the compound that contains the atom that is oxidized or reduced, not just the atom itself.

**Solution:**



Chromium changes from an O.N. of +6 in  $\text{Cr}_2\text{O}_7^{2-}$  to +3 in  $\text{Cr}^{3+}$  (is reduced) so  $\text{Cr}_2\text{O}_7^{2-}$  is the oxidizing agent. Sulfur changes from an O.N. of +4 in  $\text{SO}_3^{2-}$  to +6 in  $\text{SO}_4^{2-}$  (is oxidized) so  $\text{SO}_3^{2-}$  is the reducing agent.

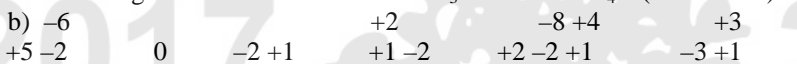

Nitrogen changes from an O.N. of +5 in  $\text{NO}_3^-$  to an O.N. of -3 in  $\text{NH}_3$  (is reduced) so  $\text{NO}_3^-$  is the oxidizing agent.

Zinc changes from an O.N. of 0 to an O.N. of +2 in  $\text{Zn}(\text{OH})_4^{2-}$  (is oxidized) so Zn is the reducing agent.

- 4.60 **Plan:** Find the moles of  $\text{Cr}_2\text{O}_7^{2-}$  from the molarity and volume information. Use the molar ratio in the balanced equation to find the moles of  $\text{C}_2\text{H}_5\text{OH}$  and multiply the moles of  $\text{C}_2\text{H}_5\text{OH}$  by its molar mass to determine the mass of  $\text{C}_2\text{H}_5\text{OH}$  present. Mass percent is calculated by dividing the mass of  $\text{C}_2\text{H}_5\text{OH}$  by the mass of the sample and multiplying by 100.

**Solution:**

$$\text{Moles of } \text{Cr}_2\text{O}_7^{2-} = (35.46 \text{ mL}) \left( \frac{10^{-3} \text{ L}}{1 \text{ mL}} \right) \left( \frac{0.05961 \text{ mol } \text{Cr}_2\text{O}_7^{2-}}{1 \text{ L}} \right) = 0.0021138 \text{ mol } \text{Cr}_2\text{O}_7^{2-}$$

$$\text{Moles of } \text{C}_2\text{H}_5\text{OH} = (0.0021138 \text{ mol } \text{Cr}_2\text{O}_7^{2-}) \left( \frac{1 \text{ mol } \text{C}_2\text{H}_5\text{OH}}{2 \text{ mol } \text{Cr}_2\text{O}_7^{2-}} \right) = 0.0010569 \text{ mol } \text{C}_2\text{H}_5\text{OH}$$

$$\text{Mass (g) of } \text{C}_2\text{H}_5\text{OH} = (0.0010569 \text{ mol } \text{C}_2\text{H}_5\text{OH}) \left( \frac{46.07 \text{ g } \text{C}_2\text{H}_5\text{OH}}{1 \text{ mol } \text{C}_2\text{H}_5\text{OH}} \right) = 0.0486914 \text{ g } \text{C}_2\text{H}_5\text{OH}$$

$$\begin{aligned} \text{Mass percent of } \text{C}_2\text{H}_5\text{OH} &= \frac{\text{mass of } \text{C}_2\text{H}_5\text{OH}}{\text{mass of sample}} (100) = \frac{0.0486914 \text{ g } \text{C}_2\text{H}_5\text{OH}}{28.00 \text{ g sample}} (100) \\ &= 0.173898 = \mathbf{0.1739\% \text{ C}_2\text{H}_5\text{OH}} \end{aligned}$$

- 4.61 **Plan:** The three types of redox reactions are combination, decomposition, and displacement. In a combination reaction, two or more reactants form one product, so the number of substances decreases. In a decomposition reaction, one reactant forms two or more products, so the number of substances increases. In a displacement reaction, the number of substances is the same, but atoms exchange places.  
**Solution:**  
a) **decomposition**                      b) **combination**                      c) **displacement**
- 4.62 **Plan:** Recall that a reactant breaks down into two or more products in a decomposition reaction, while reactants combine to form a product in a combination reaction.  
**Solution:**  
By definition, elements cannot decompose into anything simpler, so they could not be reactants in a decomposition reaction.
- 4.63 **Plan:** Review the types of redox reaction discussed in this section.  
**Solution:**  
Combination, decomposition, and displacement reactions generally produce only one compound; **combustion reactions**, however, often produce both carbon dioxide and water.
- 4.64 **Plan:** In a combination reaction, two or more reactants form one product. In a decomposition reaction, one reactant forms two or more products. In a displacement reaction, atoms or ions exchange places. Balance the reactions by inspection.  
**Solution:**  
a)  $2\text{Sb}(s) + 3\text{Cl}_2(g) \rightarrow 2\text{SbCl}_3(s)$   
**Combination:** two reactants combine to form one product.  
b)  $2\text{AsH}_3(g) \rightarrow 2\text{As}(s) + 3\text{H}_2(g)$   
**Decomposition:** one reactant breaks into two products.  
c)  $\text{Zn}(s) + \text{Fe}(\text{NO}_3)_2(aq) \rightarrow \text{Zn}(\text{NO}_3)_2(aq) + \text{Fe}(s)$   
**Displacement:** one Zn displaces one Fe atom.
- 4.65 **Plan:** In a combination reaction, two or more reactants form one product. In a decomposition reaction, one reactant forms two or more products. In a displacement reaction, atoms or ions exchange places. Balance the reactions by inspection.  
**Solution:**  
a)  $\text{Mg}(s) + 2\text{H}_2\text{O}(g) \rightarrow \text{Mg}(\text{OH})_2(s) + \text{H}_2(g)$   
**Displacement:** one Mg displaces two H atoms.  
b)  $\text{Cr}(\text{NO}_3)_3(aq) + \text{Al}(s) \rightarrow \text{Al}(\text{NO}_3)_3(aq) + \text{Cr}(s)$   
**Displacement:** one Al displaces one Cr atom.  
c)  $\text{PF}_3(g) + \text{F}_2(g) \rightarrow \text{PF}_5(g)$   
**Combination:** two reactants combine to form one product.
- 4.66 **Plan:** In a combination reaction, two or more reactants form one product. Two elements as reactants often results in a combination reaction. In a decomposition reaction, one reactant forms two or more products; one reactant only often indicates a decomposition reaction. In a displacement reaction, atoms or ions exchange places. An element and a compound as reactants often indicate a displacement reaction. Balance the reactions by inspection.  
**Solution:**  
a) The combination of two nonmetals gives a covalent compound.  
$$\text{N}_2(g) + 3\text{H}_2(g) \rightarrow 2\text{NH}_3(g)$$
  
b) Some compounds undergo thermal decomposition to simpler substances.  
$$2\text{NaClO}_3(s) \xrightarrow{\Delta} 2\text{NaCl}(s) + 3\text{O}_2(g)$$
  
c) This is a displacement reaction. Active metals like Ba can displace hydrogen from water.  
$$\text{Ba}(s) + 2\text{H}_2\text{O}(l) \rightarrow \text{Ba}(\text{OH})_2(aq) + \text{H}_2(g)$$

- 4.67 **Plan:** In a combination reaction, two or more reactants form one product. Two elements as reactants often results in a combination reaction. In a decomposition reaction, one reactant forms two or more products; one reactant only often indicates a decomposition reaction. In a displacement reaction, atoms or ions exchange places. An element and a compound as reactants often indicate a displacement reaction. Balance the reactions by inspection.

**Solution:**

a) This is a displacement reaction in which iron displaces hydrogen.

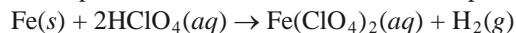

b) The combination of two nonmetals gives a covalent compound.

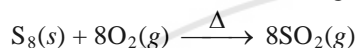

c) Some compounds undergo decomposition to their elements during electrolysis in which electrical energy is absorbed.

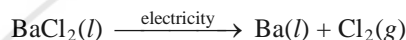

- 4.68 **Plan:** In a combination reaction, two or more reactants form one product. Two elements as reactants often results in a combination reaction. In a decomposition reaction, one reactant forms two or more products; one reactant only often indicates a decomposition reaction. In a displacement reaction, atoms or ions exchange places. An element and a compound as reactants often indicate a displacement reaction. Balance the reactions by inspection.

**Solution:**

a) Cs, a metal, and  $\text{I}_2$ , a nonmetal, combine to form the binary ionic compound, CsI.

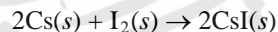

b) Al is a stronger reducing agent than Mn and is able to displace Mn from solution, i.e., cause the reduction from  $\text{Mn}^{2+}(aq)$  to  $\text{Mn}^0(s)$ .

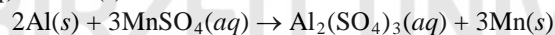

c) This is a combination reaction in which sulfur dioxide,  $\text{SO}_2$ , a nonmetal oxide, combines with oxygen,  $\text{O}_2$ , to form the higher oxide,  $\text{SO}_3$ .

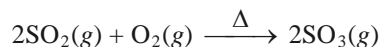

It is not clear from the problem, but energy must be added to force this reaction to proceed.

d) Butane is a four carbon hydrocarbon with the formula  $\text{C}_4\text{H}_{10}$ . It burns in the presence of oxygen,  $\text{O}_2$ , to form carbon dioxide gas and water vapor. Although this is a redox reaction that could be balanced using the oxidation number method, it is easier to balance by considering only atoms on either side of the equation. First, balance carbon and hydrogen (because they only appear in one species on each side of the equation), and then balance oxygen.

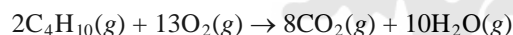

e) Total ionic equation in which soluble species are shown dissociated into ions:

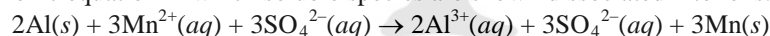

Net ionic equation in which the spectator ions are omitted:

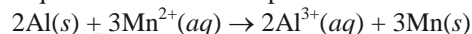

Note that the molar coefficients are not simplified because the number of electrons lost ( $6e^-$ ) must equal the electrons gained ( $6e^-$ ).

- 4.69 **Plan:** In a combination reaction, two or more reactants form one product. Two elements as reactants often results in a combination reaction. In a decomposition reaction, one reactant forms two or more products; one reactant only often indicates a decomposition reaction. In a displacement reaction, atoms or ions exchange places. An element and a compound as reactants often indicate a displacement reaction. Balance the reactions by inspection.

**Solution:**

a) Pentane is a five carbon hydrocarbon with the formula  $\text{C}_5\text{H}_{12}$ . It burns in the presence of oxygen,  $\text{O}_2$ , to form carbon dioxide gas and water vapor. Although this is a redox reaction that could be balanced using the oxidation number method, it is easier to balance by considering only atoms on either side of the equation. First, balance carbon and hydrogen (because they only appear in one species on each side of the equation), and then balance oxygen.

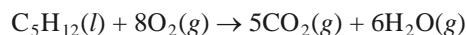

b) Phosphorus trichloride,  $\text{PCl}_3$ , is a nonmetal halide that combines with additional halogen, to form the higher halide,  $\text{PCl}_5$ .

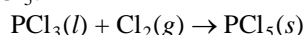

c) This is a displacement reaction. Active metals like Zn can displace hydrogen from acid.

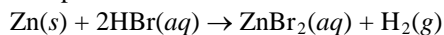

d) This is a displacement reaction in which bromine displaces iodine. A halogen higher in the periodic table can displace a halogen that is lower.

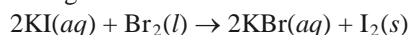

e) Total ionic equation in which soluble species are shown dissociated into ions:

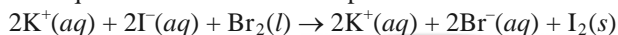

Net ionic equation in which the spectator ions are omitted:

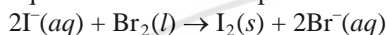

4.70 Plan: Write a balanced equation that shows the decomposition of HgO to its elements. Convert the mass of HgO to moles and use the molar ratio from the balanced equation to find the moles and then the mass of O<sub>2</sub>. Perform the same calculation to find the mass of the other product.

Solution:

The balanced chemical equation is  $2\text{HgO}(s) \xrightarrow{\Delta} 2\text{Hg}(l) + \text{O}_2(g)$ .

$$\text{Moles of HgO} = (4.27 \text{ kg HgO}) \left( \frac{10^3 \text{ g}}{1 \text{ kg}} \right) \left( \frac{1 \text{ mol HgO}}{216.6 \text{ g HgO}} \right) = 19.71376 \text{ mol HgO}$$

$$\text{Moles of O}_2 = (19.71376 \text{ mol HgO}) \left( \frac{1 \text{ mol O}_2}{2 \text{ mol HgO}} \right) = 9.85688 \text{ mol O}_2$$

$$\text{Mass (g) of O}_2 = (9.85688 \text{ mol O}_2) \left( \frac{32.00 \text{ g O}_2}{1 \text{ mol O}_2} \right) = 315.420 = \mathbf{315 \text{ g O}_2}$$

The other product is **mercury**.

$$\text{Moles of Hg} = (19.71376 \text{ mol HgO}) \left( \frac{2 \text{ mol Hg}}{2 \text{ mol HgO}} \right) = 19.71376 \text{ mol Hg}$$

$$\text{Mass (kg) Hg} = (19.71376 \text{ mol Hg}) \left( \frac{200.6 \text{ g Hg}}{1 \text{ mol Hg}} \right) \left( \frac{1 \text{ kg}}{10^3 \text{ g}} \right) = 3.95458 = \mathbf{3.95 \text{ kg Hg}}$$

4.71 Plan: Write a balanced equation that shows the decomposition of calcium chloride to its elements. Convert the mass of CaCl<sub>2</sub> to moles and use the molar ratio from the balanced equation to find the moles and then the mass of Cl<sub>2</sub>. Perform the same calculation to find the mass of the other product.

Solution:

The balanced chemical equation is  $\text{CaCl}_2(l) \xrightarrow{\text{elect}} \text{Ca}(l) + \text{Cl}_2(g)$ .

Note: The reaction cannot be done in the presence of water as elemental calcium would displace the hydrogen from the water.

$$\text{Moles of CaCl}_2 = (874 \text{ g CaCl}_2) \left( \frac{1 \text{ mol CaCl}_2}{110.98 \text{ g CaCl}_2} \right) = 7.87529 \text{ mol CaCl}_2$$

$$\text{Moles of Cl}_2 = (7.87529 \text{ mol CaCl}_2) \left( \frac{1 \text{ mol Cl}_2}{1 \text{ mol CaCl}_2} \right) = 7.87529 \text{ mol Cl}_2$$

$$\text{Mass (g) of Cl}_2 = (7.87529 \text{ mol Cl}_2) \left( \frac{70.90 \text{ g Cl}_2}{1 \text{ mol Cl}_2} \right) = 558.358 = \mathbf{558 \text{ g Cl}_2}$$

The other product is **calcium**.

$$\text{Moles of Ca} = (7.87529 \text{ mol CaCl}_2) \left( \frac{1 \text{ mol Ca}}{1 \text{ mol CaCl}_2} \right) = 7.87529 \text{ mol Ca}$$

$$\text{Mass (g) of Ca} = (7.87529 \text{ mol Ca}) \left( \frac{40.08 \text{ g Ca}}{1 \text{ mol Ca}} \right) = 315.64 = \mathbf{316 \text{ g Ca}}$$



- 4.72 **Plan:** To determine the reactant in excess, write the balanced equation (metal + O<sub>2</sub> → metal oxide), convert reactant masses to moles, and use molar ratios to see which reactant makes the smaller (“limiting”) amount of product. Use the limiting reactant to calculate the amount of product formed. Use the molar ratio to find the amount of excess reactant required to react with the limiting reactant; the amount of excess reactant that remains is the initial amount of excess reactant minus the amount required for the reaction.

**Solution:**

The balanced equation is  $4\text{Li}(s) + \text{O}_2(g) \rightarrow 2\text{Li}_2\text{O}(s)$ .

$$\text{a) Moles of Li}_2\text{O if Li limiting} = (1.62 \text{ g Li}) \left( \frac{1 \text{ mol Li}}{6.941 \text{ g Li}} \right) \left( \frac{2 \text{ mol Li}_2\text{O}}{4 \text{ mol Li}} \right) = 0.1166979 \text{ mol Li}_2\text{O}$$

$$\text{Moles of Li}_2\text{O if O}_2 \text{ limiting} = (6.50 \text{ g O}_2) \left( \frac{1 \text{ mol O}_2}{32.00 \text{ g O}_2} \right) \left( \frac{2 \text{ mol Li}_2\text{O}}{1 \text{ mol O}_2} \right) = 0.40625 \text{ mol Li}_2\text{O}$$

Li is the limiting reactant since it produces the smaller amount of product; **O<sub>2</sub> is in excess.**

b) Using Li as the limiting reagent, 0.1166979 = **0.117 mol Li<sub>2</sub>O** is formed.

c) Li is limiting, thus there will be none remaining (**0 g Li**).

$$\text{Mass (g) of Li}_2\text{O} = (0.1166979 \text{ mol Li}_2\text{O}) \left( \frac{29.88 \text{ g Li}_2\text{O}}{1 \text{ mol Li}_2\text{O}} \right) = 3.4869 = \mathbf{3.49 \text{ g Li}_2\text{O}}$$

$$\text{Mass (g) of O}_2 \text{ reacted} = (1.62 \text{ g Li}) \left( \frac{1 \text{ mol Li}}{6.941 \text{ g Li}} \right) \left( \frac{1 \text{ mol O}_2}{4 \text{ mol Li}} \right) \left( \frac{32.00 \text{ g O}_2}{1 \text{ mol O}_2} \right) = 1.867166 \text{ g O}_2$$

$$\text{Remaining O}_2 = \text{initial amount} - \text{amount reacted} = 6.50 \text{ g O}_2 - 1.867166 \text{ g O}_2 = 4.632834 = \mathbf{4.63 \text{ g O}_2}$$

- 4.73 **Plan:** To determine the reactant in excess, write the balanced equation (metal + N<sub>2</sub> → metal nitride), convert reactant masses to moles, and use molar ratios to see which reactant makes the smaller (“limiting”) amount of product. Use the limiting reactant to calculate the amount of product formed. Use the molar ratio to find the amount of excess reactant required to react with the limiting reactant; the amount of excess reactant that remains is the initial amount of excess reactant minus the amount required for the reaction.

**Solution:**

The balanced equation is  $3\text{Mg}(s) + \text{N}_2(g) \xrightarrow{\Delta} \text{Mg}_3\text{N}_2(s)$ .

$$\text{a) Moles of Mg}_3\text{N}_2 \text{ if Mg is limiting} = (2.22 \text{ g Mg}) \left( \frac{1 \text{ mol Mg}}{24.31 \text{ g Mg}} \right) \left( \frac{1 \text{ mol Mg}_3\text{N}_2}{3 \text{ mol Mg}} \right) = 0.030440 \text{ mol Mg}_3\text{N}_2$$

$$\text{Moles of Mg}_3\text{N}_2 \text{ if N}_2 \text{ is limiting} = (3.75 \text{ g N}_2) \left( \frac{1 \text{ mol N}_2}{28.02 \text{ g N}_2} \right) \left( \frac{1 \text{ mol Mg}_3\text{N}_2}{1 \text{ mol N}_2} \right) = 0.13383 \text{ mol Mg}_3\text{N}_2$$

Mg is the limiting reactant since it produces the smaller amount of product; **N<sub>2</sub> is present in excess.**

b) Using Mg as the limiting reactant, 0.030440 = **0.0304 mol Mg<sub>3</sub>N<sub>2</sub>** is formed.

c) There will be **0 Mg** remaining since it is the limiting reagent and will be completely consumed.

$$\text{Mass (g) of Mg}_3\text{N}_2 = (0.030440 \text{ mol Mg}_3\text{N}_2) \left( \frac{100.95 \text{ g Mg}_3\text{N}_2}{1 \text{ mol Mg}_3\text{N}_2} \right) = 3.07292 = \mathbf{3.07 \text{ g Mg}_3\text{N}_2}$$

$$\text{Mass (g) of N}_2 \text{ reacted} = (2.22 \text{ g Mg}) \left( \frac{1 \text{ mol Mg}}{24.31 \text{ g Mg}} \right) \left( \frac{1 \text{ mol N}_2}{3 \text{ mol Mg}} \right) \left( \frac{28.02 \text{ g N}_2}{1 \text{ mol N}_2} \right) = 0.852933 \text{ g N}_2$$

$$\text{Remaining N}_2 = \text{initial amount} - \text{amount reacted} = 3.75 \text{ g N}_2 - 0.852933 \text{ g N}_2 = 2.897067 = \mathbf{2.90 \text{ g N}_2}$$

- 4.74 **Plan:** Since mass must be conserved, the original amount of mixture – amount of remaining solid = mass of carbon dioxide produced. Write a balanced equation and use molar ratios to convert from the mass of CO<sub>2</sub> produced to the amount of CaCO<sub>3</sub> reacted. Mass percent is calculated by dividing the mass of CaCO<sub>3</sub> by the mass of the sample and multiplying by 100.

**Solution:**

$\text{CaCO}_3(s) \xrightarrow{\Delta} \text{CaO}(s) + \text{CO}_2(g)$

$$\text{Mass (g) of CO}_2 \text{ produced} = \text{mass of mixture} - \text{mass of remaining solid} = 0.693 \text{ g} - 0.508 \text{ g} = 0.185 \text{ g CO}_2$$

$$\text{Mass (g) of CaCO}_3 = (0.185 \text{ g CO}_2) \left( \frac{1 \text{ mol CO}_2}{44.01 \text{ g CO}_2} \right) \left( \frac{1 \text{ mol CaCO}_3}{1 \text{ mol CO}_2} \right) \left( \frac{100.09 \text{ g CaCO}_3}{1 \text{ mol CaCO}_3} \right) = 0.420737 \text{ g CaCO}_3$$

$$\text{Mass \% CaCO}_3 = \frac{\text{mass of CaCO}_3}{\text{mass of sample}} (100\%) = \frac{0.420737 \text{ g CaCO}_3}{0.693 \text{ g sample}} (100\%) = 60.7124 = \mathbf{60.7\% \text{ CaCO}_3}$$

- 4.75 Plan: Write the balanced equation for the displacement reaction, convert reactant masses to moles, and use molar ratios to see which reactant makes the smaller (“limiting”) amount of product. Use the limiting reactant to calculate the amount of product formed.

Solution:

The balanced reaction is  $2\text{Al}(s) + \text{Fe}_2\text{O}_3(s) \rightarrow 2\text{Fe}(l) + \text{Al}_2\text{O}_3(s)$ .

$$\text{Moles of Fe if Al is limiting} = (1.50 \text{ kg Al}) \left( \frac{10^3 \text{ g}}{1 \text{ kg}} \right) \left( \frac{1 \text{ mol Al}}{26.98 \text{ g Al}} \right) \left( \frac{2 \text{ mol Fe}}{2 \text{ mol Al}} \right) = 55.59674 \text{ mol Fe}$$

$$\text{Moles of Fe if Fe}_2\text{O}_3 \text{ is limiting} = (25.0 \text{ mol Fe}_2\text{O}_3) \left( \frac{2 \text{ mol Fe}}{1 \text{ mol Fe}_2\text{O}_3} \right) = 50.0 \text{ mol Fe}$$

$\text{Fe}_2\text{O}_3$  is the limiting reactant since it produces the smaller amount of Fe; 50.0 moles of Fe forms.

$$\text{Mass (g) of Fe} = (50.0 \text{ mol Fe}) \left( \frac{55.85 \text{ g Fe}}{1 \text{ mol Fe}} \right) = 2792.5 = \mathbf{2790 \text{ g Fe}}$$

- 4.76 Plan: Ferrous ion is  $\text{Fe}^{2+}$ . Write a reaction to show the conversion of Fe to  $\text{Fe}^{2+}$ . Convert the mass of Fe in a 125-g serving to the mass of Fe in a 737-g sample. Use molar mass to convert mass of Fe to moles of Fe and use Avogadro’s number to convert moles of Fe to moles of ions.

Solution:

a) Fe oxidizes to  $\text{Fe}^{2+}$  with a loss of 2 electrons. The  $\text{H}^+$  in the acidic food is reduced to  $\text{H}_2$  with a gain of 2 electrons. The balanced reaction is:

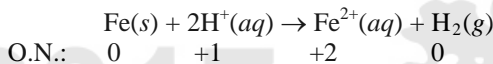

O.N.:    0        +1        +2        0

$$\text{b) Mass (g) of Fe in the jar of tomato sauce} = (737 \text{ g sauce}) \left( \frac{49 \text{ mg Fe}}{125 \text{ g sauce}} \right) \left( \frac{10^{-3} \text{ g}}{1 \text{ mg}} \right) = 0.288904 \text{ g Fe}$$

$$\begin{aligned} \text{Number of Fe}^{2+} \text{ ions} &= (0.288904 \text{ g Fe}) \left( \frac{1 \text{ mol Fe}}{55.85 \text{ g Fe}} \right) \left( \frac{1 \text{ mol Fe}^{2+}}{1 \text{ mol Fe}} \right) \left( \frac{6.022 \times 10^{23} \text{ Fe}^{2+} \text{ ions}}{1 \text{ mol Fe}^{2+}} \right) \\ &= 3.11509 \times 10^{21} = \mathbf{3.1 \times 10^{21} \text{ Fe}^{2+} \text{ ions per jar of sauce}} \end{aligned}$$

- 4.77 Plan: Convert the mass of glucose to moles and use the molar ratios from the balanced equation to find the moles of ethanol and  $\text{CO}_2$ . The amount of ethanol is converted from moles to grams using its molar mass. The amount of  $\text{CO}_2$  is converted from moles to volume in liters using the conversion factor given.

Solution:

$$\text{Moles of C}_2\text{H}_5\text{OH} = (100. \text{ g C}_6\text{H}_{12}\text{O}_6) \left( \frac{1 \text{ mol C}_6\text{H}_{12}\text{O}_6}{180.16 \text{ g C}_6\text{H}_{12}\text{O}_6} \right) \left( \frac{2 \text{ mol C}_2\text{H}_5\text{OH}}{1 \text{ mol C}_6\text{H}_{12}\text{O}_6} \right) = 1.11012 \text{ mol C}_2\text{H}_5\text{OH}$$

$$\text{Mass (g) of C}_2\text{H}_5\text{OH} = (1.11012 \text{ mol C}_2\text{H}_5\text{OH}) \left( \frac{46.07 \text{ g C}_2\text{H}_5\text{OH}}{1 \text{ mol C}_2\text{H}_5\text{OH}} \right) = 51.143 = \mathbf{51.1 \text{ g C}_2\text{H}_5\text{OH}}$$

$$\text{Moles of CO}_2 = (100. \text{ g C}_6\text{H}_{12}\text{O}_6) \left( \frac{1 \text{ mol C}_6\text{H}_{12}\text{O}_6}{180.16 \text{ g C}_6\text{H}_{12}\text{O}_6} \right) \left( \frac{2 \text{ mol CO}_2}{1 \text{ mol C}_6\text{H}_{12}\text{O}_6} \right) = 1.11012 \text{ mol CO}_2$$

$$\text{Volume (L) of CO}_2 = (1.11012 \text{ mol CO}_2) \left( \frac{22.4 \text{ L CO}_2}{1 \text{ mol CO}_2} \right) = 24.8667 = \mathbf{24.9 \text{ L CO}_2}$$

- 4.78 **Plan:** Find the moles of  $\text{KMnO}_4$  from the molarity and volume information. Use the molar ratio in the balanced equation to find the moles and then mass of iron. Mass percent is calculated by dividing the mass of iron by the mass of the sample and multiplying by 100.

**Solution:**

$$\text{Moles of KMnO}_4 = (39.32 \text{ mL}) \left( \frac{10^{-3} \text{ L}}{1 \text{ mL}} \right) \left( \frac{0.03190 \text{ mol MnO}_4^-}{\text{L}} \right) = 0.00125431 \text{ mol KMnO}_4$$

$$\text{Mass (g) of Fe} = (0.00125431 \text{ mol MnO}_4^-) \left( \frac{5 \text{ mol Fe}^{2+}}{1 \text{ mol MnO}_4^-} \right) \left( \frac{55.85 \text{ g Fe}}{1 \text{ mol Fe}^{2+}} \right) = 0.350266 \text{ g Fe}$$

$$\text{Mass \% of Fe} = \frac{\text{mass of Fe}}{\text{mass of sample}} (100) = \frac{0.350266 \text{ g}}{1.1081 \text{ g}} (100) = 31.6096 = \mathbf{31.61\% \text{ Fe}}$$

- 4.79 **Plan:** Write balanced equations for the two acid-base reactions. Find the moles of  $\text{H}_2\text{SO}_4$  from the molarity and volume information and use the molar ratio in the balanced equation for the reaction of  $\text{H}_2\text{SO}_4$  and  $\text{NaOH}$  to find the moles of  $\text{NaOH}$  used in the titration. Divide the moles of  $\text{NaOH}$  by its volume to determine its molarity. Then find the moles of  $\text{NaOH}$  used in the titration of  $\text{HCl}$  by multiplying the  $\text{NaOH}$  molarity by its volume; use the molar ratio in this reaction to find moles of  $\text{HCl}$ . Dividing moles of  $\text{HCl}$  by its volume gives its molarity.

**Solution:**

Write the balanced chemical equations:

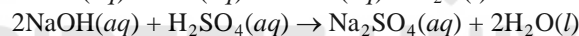
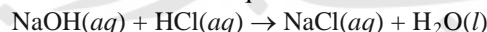

Determine the  $\text{NaOH}$  concentration from the reaction of  $\text{NaOH}$  with  $\text{H}_2\text{SO}_4$ :

$$\text{Moles of H}_2\text{SO}_4 = (50.0 \text{ mL}) \left( \frac{10^{-3} \text{ L}}{1 \text{ mL}} \right) \left( \frac{0.0782 \text{ mol H}_2\text{SO}_4}{\text{L}} \right) = 0.00391 \text{ mol H}_2\text{SO}_4$$

$$\text{Moles of NaOH} = (0.00391 \text{ mol H}_2\text{SO}_4) \left( \frac{2 \text{ mol NaOH}}{1 \text{ mol H}_2\text{SO}_4} \right) = 0.00782 \text{ mol NaOH}$$

$$\text{Molarity of NaOH} = \left( \frac{0.00782}{18.4 \text{ mL}} \right) \left( \frac{1 \text{ mL}}{10^{-3} \text{ L}} \right) = \mathbf{0.425 \text{ M NaOH}}$$

Use the  $\text{NaOH}$  concentration and the reaction of  $\text{HCl}$  with  $\text{NaOH}$  to determine  $\text{HCl}$  concentration:

$$\text{Moles of NaOH} = (27.5 \text{ mL}) \left( \frac{10^{-3} \text{ L}}{1 \text{ mL}} \right) \left( \frac{0.425 \text{ mol NaOH}}{\text{L}} \right) = 0.0116875 \text{ mol NaOH}$$

$$\text{Moles of HCl} = (0.0116875 \text{ mol NaOH}) \left( \frac{1 \text{ mol HCl}}{1 \text{ mol NaOH}} \right) = 0.0116875 \text{ mol HCl}$$

$$\text{Molarity of HCl} = (0.0116875 \text{ mol HCl}) \left( \frac{1}{100. \text{ mL}} \right) \left( \frac{1 \text{ mL}}{10^{-3} \text{ L}} \right) = 0.116875 = \mathbf{0.117 \text{ M HCl}}$$

- 4.80 **Plan:** Recall that the total ionic equation shows all soluble ionic substances dissociated into ions and the net ionic equation omits the spectator ions. Use the molar ratio in the balanced reaction to find the moles of acid and base. Divide the moles of acid and base by the volume to obtain the molarity.

**Solution:**

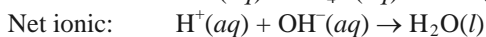
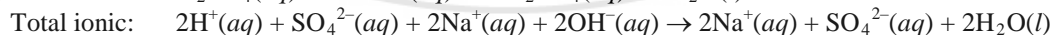

( $\text{Na}^+$  and  $\text{SO}_4^{2-}$  are spectator ions.)

b) Moles of  $\text{H}_2\text{SO}_4 = (2 \text{ orange spheres}) \left( \frac{0.010 \text{ mol SO}_4^{2-}}{1 \text{ orange sphere}} \right) \left( \frac{1 \text{ mol H}_2\text{SO}_4}{1 \text{ mol SO}_4^{2-}} \right) = \mathbf{0.020 \text{ mol H}_2\text{SO}_4}$

$$\text{Moles of NaOH} = (0.020 \text{ mol H}_2\text{SO}_4) \left( \frac{2 \text{ mol NaOH}}{1 \text{ mol H}_2\text{SO}_4} \right) = \mathbf{0.040 \text{ mol NaOH}}$$

$$\text{c) Molarity of H}_2\text{SO}_4 = (0.020 \text{ mol H}_2\text{SO}_4) \left( \frac{1}{25 \text{ mL}} \right) \left( \frac{1 \text{ mL}}{10^{-3} \text{ L}} \right) = \mathbf{0.80 \text{ M H}_2\text{SO}_4}$$

$$\text{Molarity of NaOH} = (0.040 \text{ mol NaOH}) \left( \frac{1}{25 \text{ mL}} \right) \left( \frac{1 \text{ mL}}{10^{-3} \text{ L}} \right) = \mathbf{1.6 \text{ M NaOH}}$$

- 4.81 **Plan:** Write balanced chemical equations for the acid-base titration reactions. To find the concentration of HA, find the moles of NaOH used for its titration by multiplying the molarity of NaOH by the volume used in the titration and using the molar ratio to find the moles of HA; dividing moles of HA by its volume gives the molarity. Multiply the molarity of HA by the volume of HA in the acid mixture to find the moles of HA in the mixture. Use the molar ratio to find the volume of NaOH required to titrate this amount of HA. The total volume of NaOH used in the titration of the mixture minus the volume required to titrate HA is the volume of NaOH required to titrate HB. Use this volume and molarity of NaOH and the molar ratio to find the moles and then molarity of HB. The volume of HB in the acid mixture is the total volume minus the volume of HA.

**Solution:**

The balanced chemical equations for HA or HB with sodium hydroxide are the same. For HA it is:

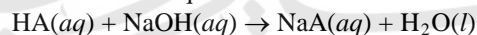

To find the concentration of HA:

$$\text{Moles of NaOH} = (87.3 \text{ mL}) \left( \frac{10^{-3} \text{ L}}{1 \text{ mL}} \right) \left( \frac{0.0906 \text{ mol NaOH}}{\text{L}} \right) = 0.007909 \text{ mol NaOH}$$

$$\text{Moles of HA} = (0.007909 \text{ mol NaOH}) \left( \frac{1 \text{ mol HA}}{1 \text{ mol NaOH}} \right) = 0.007909 \text{ mol HA}$$

$$\text{Molarity of HA} = (0.007909 \text{ mol HA}) \left( \frac{1}{43.5 \text{ mL}} \right) \left( \frac{1 \text{ mL}}{10^{-3} \text{ L}} \right) = 0.1818248 = \mathbf{0.182 \text{ M HA}}$$

The titration of the acid mixture involves the reaction of NaOH with both of the acids.

$$\text{Moles of HA in the acid mixture} = (37.2 \text{ mL}) \left( \frac{10^{-3} \text{ L}}{1 \text{ mL}} \right) \left( \frac{0.1818248 \text{ mol HA}}{\text{L}} \right) = 0.0067639 \text{ mol HA}$$

Volume (mL) of NaOH required to titrate HA =

$$(0.0067639 \text{ mol HA}) \left( \frac{1 \text{ mol NaOH}}{1 \text{ mol HA}} \right) \left( \frac{1 \text{ L}}{0.0906 \text{ mol NaOH}} \right) \left( \frac{1 \text{ mL}}{10^{-3} \text{ L}} \right) = 74.6565 \text{ mL NaOH}$$

$$\begin{aligned} \text{Volume of NaOH required to titrate HB} &= \text{total NaOH volume} - \text{volume of NaOH required to titrate HA} \\ &= 96.4 \text{ mL} - 74.6565 \text{ mL} = 21.7435 \text{ mL NaOH} \end{aligned}$$

$$\text{Moles of HB} = (21.7435 \text{ mL}) \left( \frac{10^{-3} \text{ L}}{1 \text{ mL}} \right) \left( \frac{0.0906 \text{ mol NaOH}}{\text{L}} \right) \left( \frac{1 \text{ mol HB}}{1 \text{ mol NaOH}} \right) = 0.00196996 \text{ mol HB}$$

$$\text{Volume (mL) of HB} = \text{Volume of mixture} - \text{volume of HA} = 50.0 \text{ mL} - 37.2 \text{ mL} = 12.8 \text{ mL}$$

$$\text{Molarity of HB} = (0.00196996 \text{ mol HB}) \left( \frac{1}{12.8 \text{ mL}} \right) \left( \frac{1 \text{ mL}}{10^{-3} \text{ L}} \right) = 0.153903 = \mathbf{0.154 \text{ M HB}}$$

- 4.82 **Plan:** For part a), assign oxidation numbers to each element; the oxidizing agent has an atom whose oxidation number decreases while the reducing agent has an atom whose oxidation number increases. For part b), use the molar ratios, beginning with step 3, to find the moles of NO<sub>2</sub>, then moles of NO, then moles of NH<sub>3</sub> required to produce the given mass of HNO<sub>3</sub>.

**Solution:**

a) *Step 1*

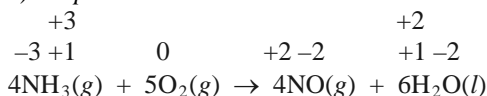

N is oxidized from -3 in  $\text{NH}_3$  to +2 in  $\text{NO}$ ; O is reduced from 0 in  $\text{O}_2$  to -2 in  $\text{NO}$ .

**Oxidizing agent =  $\text{O}_2$       Reducing agent =  $\text{NH}_3$**

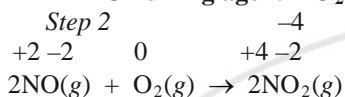

N is oxidized from +2 in  $\text{NO}$  to +4 in  $\text{NO}_2$ ; O is reduced from 0 in  $\text{O}_2$  to -2 in  $\text{NO}_2$ .

**Oxidizing agent =  $\text{O}_2$       Reducing agent =  $\text{NO}$**

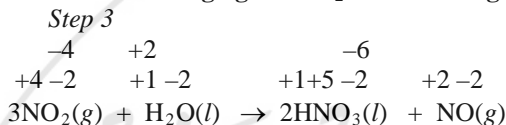

N is oxidized from +4 in  $\text{NO}_2$  to +5 in  $\text{HNO}_3$ ; N is reduced from +4 in  $\text{NO}_2$  to +2 in  $\text{NO}$ .

**Oxidizing agent =  $\text{NO}_2$       Reducing agent =  $\text{NO}_2$**

b) Moles of  $\text{NO}_2 = \left(3.0 \times 10^4 \text{ kg HNO}_3\right) \left(\frac{10^3 \text{ g}}{1 \text{ kg}}\right) \left(\frac{1 \text{ mol HNO}_3}{63.02 \text{ g HNO}_3}\right) \left(\frac{3 \text{ mol NO}_2}{2 \text{ mol HNO}_3}\right) = 7.14059 \times 10^5 \text{ mol NO}_2$

$$\text{Moles of NO} = \left(7.14059 \times 10^5 \text{ mol NO}_2\right) \left(\frac{2 \text{ mol NO}}{2 \text{ mol NO}_2}\right) = 7.14059 \times 10^5 \text{ mol NO}$$

$$\text{Moles of NH}_3 = \left(7.14059 \times 10^5 \text{ mol NO}\right) \left(\frac{4 \text{ mol NH}_3}{4 \text{ mol NO}}\right) = 7.14059 \times 10^5 \text{ mol NH}_3$$

$$\text{Mass (kg) of NH}_3 = \left(7.14059 \times 10^5 \text{ mol NH}_3\right) \left(\frac{17.03 \text{ g NH}_3}{1 \text{ mol NH}_3}\right) \left(\frac{1 \text{ kg}}{10^3 \text{ g}}\right) = 1.21604 \times 10^4 = \mathbf{1.2 \times 10^4 \text{ kg NH}_3}$$

- 4.83 **Plan:** Write the formulas of the reactants; create cation-anion combinations other than the original reactants and determine if they are insoluble. A precipitate forms if reactant ions can form combinations that are insoluble, as determined by the solubility rules in Table 4.1. Any ions not involved in a precipitate are spectator ions and are omitted from the net ionic equation. For the acid-base reactions, strong acids and bases dissociate completely in water and can be written as ions in a total ionic equation; weak acids and bases dissociate into ions only to a small extent, so these substances appear undissociated in total ionic equations.

**Solution:**

- a)  $\text{MnS}(\text{s}) + 2 \text{HBr}(\text{aq}) \rightarrow \text{MnBr}_2(\text{aq}) + \text{H}_2\text{S}(\text{g})$   
 $\text{MnS}(\text{s}) + 2 \text{H}^+(\text{aq}) \rightarrow \text{Mn}^{2+}(\text{aq}) + \text{H}_2\text{S}(\text{g})$
- b)  $\text{K}_2\text{CO}_3(\text{aq}) + \text{Sr}(\text{NO}_3)_2(\text{aq}) \rightarrow \text{SrCO}_3(\text{s}) + 2 \text{KNO}_3(\text{aq})$   
 $\text{CO}_3^{2-}(\text{aq}) + \text{Sr}^{2+}(\text{aq}) \rightarrow \text{SrCO}_3(\text{s})$
- c)  $\text{KNO}_2(\text{aq}) + \text{HCl}(\text{aq}) \rightarrow \text{HNO}_2(\text{aq}) + \text{KCl}(\text{aq})$   
 $\text{NO}_2^-(\text{aq}) + \text{H}^+(\text{aq}) \rightarrow \text{HNO}_2(\text{aq})$
- d)  $\text{Ca}(\text{OH})_2(\text{aq}) + \text{HNO}_3(\text{aq}) \rightarrow \text{Ca}(\text{NO}_3)_2(\text{aq}) + 2 \text{H}_2\text{O}(\text{l})$   
 $\text{OH}^-(\text{aq}) + \text{H}^+(\text{aq}) \rightarrow \text{H}_2\text{O}(\text{l})$
- e)  $\text{Ba}(\text{C}_2\text{H}_3\text{O}_2)_2(\text{aq}) + \text{FeSO}_4(\text{aq}) \rightarrow \text{BaSO}_4(\text{s}) + \text{Fe}(\text{C}_2\text{H}_3\text{O}_2)_2(\text{aq})$   
 $\text{Ba}^{2+}(\text{aq}) + \text{SO}_4^{2-}(\text{aq}) \rightarrow \text{BaSO}_4(\text{s})$
- f)  $\text{Ba}(\text{OH})_2(\text{aq}) + 2 \text{HCN}(\text{aq}) \rightarrow \text{Ba}(\text{CN})_2(\text{aq}) + 2 \text{H}_2\text{O}(\text{l})$   
 $\text{OH}^-(\text{aq}) + \text{HCN}(\text{aq}) \rightarrow \text{CN}^-(\text{aq}) + \text{H}_2\text{O}(\text{l})$
- g)  $\text{Cu}(\text{NO}_3)_2(\text{aq}) + \text{H}_2\text{S}(\text{aq}) \rightarrow \text{CuS}(\text{s}) + 2 \text{HNO}_3(\text{aq})$   
 $\text{Cu}^{2+}(\text{aq}) + \text{H}_2\text{S}(\text{aq}) \rightarrow \text{CuS}(\text{s}) + 2 \text{H}^+(\text{aq})$
- h)  $\text{Mg}(\text{OH})_2(\text{s}) + 2 \text{HClO}_3(\text{aq}) \rightarrow \text{Mg}(\text{ClO}_3)_2(\text{aq}) + 2 \text{H}_2\text{O}(\text{l})$   
 $\text{Mg}(\text{OH})_2(\text{s}) + 2 \text{H}^+(\text{aq}) \rightarrow \text{Mg}^{2+}(\text{aq}) + 2 \text{H}_2\text{O}(\text{l})$
- i)  $\text{KCl}(\text{aq}) + (\text{NH}_4)_3\text{PO}_4(\text{aq}) \rightarrow \text{No Reaction}$

- 4.84 **Plan:** In part a), use the density of the alloy to find the volume of a 0.263-g sample of alloy. That volume is the sum of the volume of Mg and Al in the alloy. Letting  $x = \text{mass of Mg}$  and  $0.263 - x = \text{mass of Al}$ , find the volume of each metal and set that equal to the total volume of the alloy. In part b), write balanced displacement reactions in which Mg and Al displace hydrogen from the HCl to produce  $\text{H}_2$ . Use the molar ratios to find the masses of Mg and Al that must be present to produce the given amount of  $\text{H}_2$ . In part c), write balanced reactions for the formation of  $\text{MgO}$  and  $\text{Al}_2\text{O}_3$  and use molar ratios to find the masses of Mg and Al that must be present in the sample to produce the given amount of oxide.

**Solution:**

a) Let  $x = \text{mass of Mg}$  and  $0.263 - x = \text{mass of Al}$

$$\text{Volume (cm}^3\text{) of alloy} = (0.263 \text{ g alloy}) \left( \frac{1 \text{ cm}^3}{2.40 \text{ g alloy}} \right) = 0.10958 \text{ cm}^3$$

Volume of alloy = volume of Mg + volume of Al

$$0.10958 \text{ cm}^3 = (x \text{ g Mg}) \left( \frac{1 \text{ cm}^3 \text{ Mg}}{1.74 \text{ g Mg}} \right) + ((0.263 - x) \text{ g Al}) \left( \frac{1 \text{ cm}^3 \text{ Al}}{2.70 \text{ g Al}} \right)$$

$$0.10958 \text{ cm}^3 = 0.574713x + 0.097407 - 0.37037x$$

$$0.012173 = 0.204343x$$

$$x = 0.05957 \text{ g Mg}$$

$$\text{Mass percent Mg} = \frac{\text{mass of Mg}}{\text{mass of alloy sample}} (100) = \frac{0.05957 \text{ g Mg}}{0.263 \text{ g sample alloy}} (100) = 22.6502 = \mathbf{22.7\% \text{ Mg}}$$

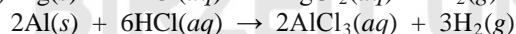

Let  $x = \text{mass of Mg}$  and  $0.263 - x = \text{mass of Al}$

Moles of  $\text{H}_2$  produced = moles of  $\text{H}_2$  from Mg + moles of  $\text{H}_2$  from Al

$$1.38 \times 10^{-2} \text{ mol H}_2 = (x \text{ g Mg}) \left( \frac{1 \text{ mol Mg}}{24.31 \text{ g Mg}} \right) \left( \frac{1 \text{ mol H}_2}{1 \text{ mol Mg}} \right) + ((0.263 - x) \text{ g Al}) \left( \frac{1 \text{ mol Al}}{26.98 \text{ g Al}} \right) \left( \frac{3 \text{ mol H}_2}{2 \text{ mol Al}} \right)$$

$$1.38 \times 10^{-2} \text{ mol H}_2 = 0.041135x + 0.014622 - 0.055597x$$

$$8.22 \times 10^{-4} = 0.014462x$$

$$x = 0.05684 \text{ g Mg}$$

$$\text{Mass percent Mg} = \frac{\text{mass of Mg}}{\text{mass of alloy sample}} (100) = \frac{0.05684 \text{ g Mg}}{0.263 \text{ g sample alloy}} (100) = 21.6122 = \mathbf{21.6\% \text{ Mg}}$$

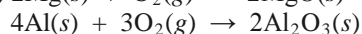
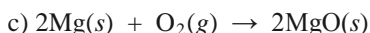

Let  $x = \text{mass of Mg}$  and  $0.263 - x = \text{mass of Al}$

Mass of oxide produced = mass of  $\text{MgO}$  from Mg + mass of  $\text{Al}_2\text{O}_3$  from Al

$$0.483 \text{ g oxide} =$$

$$(x \text{ g Mg}) \left( \frac{1 \text{ mol Mg}}{24.31 \text{ g Mg}} \right) \left( \frac{2 \text{ mol MgO}}{2 \text{ mol Mg}} \right) \left( \frac{40.31 \text{ g MgO}}{1 \text{ mol MgO}} \right) + ((0.263 - x) \text{ g Al}) \left( \frac{1 \text{ mol Al}}{26.98 \text{ g Al}} \right) \left( \frac{2 \text{ mol Al}_2\text{O}_3}{4 \text{ mol Al}} \right) \left( \frac{101.96 \text{ g Al}_2\text{O}_3}{1 \text{ mol Al}_2\text{O}_3} \right)$$

$$0.483 \text{ g} = 1.6582x + 0.49695 - 1.88955x$$

$$0.01395 = 0.23135x$$

$$x = 0.060298 \text{ g Mg}$$

$$\text{Mass percent Mg} = \frac{\text{mass of Mg}}{\text{mass of alloy sample}} (100) = \frac{0.060298 \text{ g Mg}}{0.263 \text{ g sample alloy}} (100) = 22.927 = \mathbf{22.9\% \text{ Mg}}$$

- 4.85 **Plan:** Write a balanced equation and use the molar ratio between  $\text{Na}_2\text{O}_2$  and  $\text{CO}_2$  to convert the amount of  $\text{Na}_2\text{O}_2$  given to the amount of  $\text{CO}_2$  that reacts with that amount. Convert that amount of  $\text{CO}_2$  to liters of air.

**Solution:**

The reaction is:  $2\text{Na}_2\text{O}_2(s) + 2\text{CO}_2(g) \rightarrow 2\text{Na}_2\text{CO}_3(s) + \text{O}_2(g)$ .

$$\text{Mass (g) of CO}_2 = (80.0 \text{ g Na}_2\text{O}_2) \left( \frac{1 \text{ mol Na}_2\text{O}_2}{77.98 \text{ g Na}_2\text{O}_2} \right) \left( \frac{2 \text{ mol CO}_2}{2 \text{ mol Na}_2\text{O}_2} \right) \left( \frac{44.01 \text{ g CO}_2}{1 \text{ mol CO}_2} \right) = 45.1500 \text{ g CO}_2$$

$$\text{Volume (L) of air} = (45.150 \text{ g CO}_2) \left( \frac{\text{L air}}{0.0720 \text{ g CO}_2} \right) = 627.08 = \mathbf{627 \text{ L air}}$$

- 4.86 Plan: Convert the given volume of seawater to units of mL and use the density of seawater to find the mass of that volume of seawater. Use the given % by mass of Mg in seawater to find the mass of Mg.

Solution:

$$\text{Volume (mL) of seawater} = (1.00 \text{ km}^3) \left( \frac{10^3 \text{ m}}{1 \text{ km}} \right)^3 \left( \frac{1 \text{ cm}}{10^{-2} \text{ m}} \right)^3 \left( \frac{1 \text{ mL}}{1 \text{ cm}^3} \right) = 1.00 \times 10^{15} \text{ mL}$$

$$\text{Mass (g) of seawater} = (1.00 \times 10^{15} \text{ mL}) \left( \frac{1.04 \text{ g}}{1 \text{ mL}} \right) = 1.04 \times 10^{15} \text{ g}$$

$$\text{Mass (kg) Mg} = (1.04 \times 10^{15} \text{ mL}) \left( \frac{0.13\% \text{ Mg}}{100\%} \right) \left( \frac{1 \text{ kg}}{10^3 \text{ g}} \right) = 1.3520 \times 10^9 = \mathbf{1.4 \times 10^9 \text{ kg Mg}}$$

- 4.87 Plan: To determine the reactant in excess, convert reactant masses to moles, and use molar ratios to see which reactant makes the smaller (“limiting”) amount of product. Use the limiting reactant to calculate the amount of product formed. Use the molar ratio to find the amount of excess reactant required to react with the limiting reactant; the amount of excess reactant that remains is the initial amount of excess reactant minus the amount required for the reaction. Multiply moles of products and excess reactant by Avogadro’s number to obtain number of molecules.

Solution:

$$\begin{aligned} \text{a) Moles of C}_2\text{H}_5\text{Cl if C}_2\text{H}_4 \text{ is limiting} &= (0.100 \text{ kg C}_2\text{H}_4) \left( \frac{10^3 \text{ g}}{1 \text{ kg}} \right) \left( \frac{1 \text{ mol C}_2\text{H}_4}{28.05 \text{ g C}_2\text{H}_4} \right) \left( \frac{1 \text{ mol C}_2\text{H}_5\text{Cl}}{1 \text{ mol C}_2\text{H}_4} \right) \\ &= 3.56506 \text{ mol C}_2\text{H}_5\text{Cl} \end{aligned}$$

$$\begin{aligned} \text{Moles of C}_2\text{H}_5\text{Cl if HCl is limiting} &= (0.100 \text{ kg HCl}) \left( \frac{10^3 \text{ g}}{1 \text{ kg}} \right) \left( \frac{1 \text{ mol HCl}}{36.46 \text{ g HCl}} \right) \left( \frac{1 \text{ mol C}_2\text{H}_5\text{Cl}}{1 \text{ mol HCl}} \right) \\ &= 2.74273 \text{ mol C}_2\text{H}_5\text{Cl} \end{aligned}$$

The HCl is limiting.

Moles HCl remaining = 0 mol

$$\text{Moles of C}_2\text{H}_4 \text{ initially present} = (0.100 \text{ kg C}_2\text{H}_4) \left( \frac{10^3 \text{ g}}{1 \text{ kg}} \right) \left( \frac{1 \text{ mol C}_2\text{H}_4}{28.05 \text{ g C}_2\text{H}_4} \right) = 3.56506 \text{ mol C}_2\text{H}_4$$

$$\text{Moles of C}_2\text{H}_4 \text{ that react} = (0.100 \text{ kg HCl}) \left( \frac{10^3 \text{ g}}{1 \text{ kg}} \right) \left( \frac{1 \text{ mol HCl}}{36.46 \text{ g HCl}} \right) \left( \frac{1 \text{ mol C}_2\text{H}_4}{1 \text{ mol HCl}} \right) = 2.74273 \text{ mol C}_2\text{H}_4$$

Moles of C<sub>2</sub>H<sub>4</sub> remaining = initial moles – reacted moles = 3.56506 mol – 2.74273 mol = 0.82233 mol C<sub>2</sub>H<sub>4</sub>

Moles of C<sub>2</sub>H<sub>5</sub>Cl formed = 2.74273 mol C<sub>2</sub>H<sub>5</sub>Cl

Total moles of gas = moles HCl + moles C<sub>2</sub>H<sub>4</sub> + moles C<sub>2</sub>H<sub>5</sub>Cl = 0 mol + 0.82233 mol + 2.74273 mol = 3.56506 mol

$$\text{Molecules of gas} = (3.56506 \text{ mol gas}) \left( \frac{6.022 \times 10^{23} \text{ molecules}}{1 \text{ mol gas}} \right) = 2.146879 \times 10^{24} = \mathbf{2.15 \times 10^{24} \text{ molecules}}$$

b) This will still be based on the HCl as the limiting reactant.

$$\text{Initial moles of HCl} = (0.100 \text{ kg HCl}) \left( \frac{10^3 \text{ g}}{1 \text{ kg}} \right) \left( \frac{1 \text{ mol HCl}}{36.46 \text{ g HCl}} \right) = 2.74273 \text{ mol HCl}$$

Moles of HCl remaining = initial moles/2 = (2.74273 mol HCl)/2 = 1.371365 mol HCl

$$\text{Moles of C}_2\text{H}_4 \text{ reacting with half of HCl} = (1.371365 \text{ mol HCl}) \left( \frac{1 \text{ mol C}_2\text{H}_4}{1 \text{ mol HCl}} \right) = 1.371365 \text{ mol C}_2\text{H}_4$$

$$\text{Moles of C}_2\text{H}_4 \text{ remaining} = \text{initial moles} - \text{reacted moles} = 3.56506 \text{ mol} - 1.371365 \text{ mol} = 2.193695 \text{ mol C}_2\text{H}_4$$

$$\text{Moles of C}_2\text{H}_5\text{Cl formed} = (1.371365 \text{ mol HCl}) \left( \frac{1 \text{ mol C}_2\text{H}_5\text{Cl}}{1 \text{ mol HCl}} \right) = 1.371365 \text{ mol C}_2\text{H}_5\text{Cl}$$

$$\text{Total moles of gas} = \text{moles HCl} + \text{moles C}_2\text{H}_4 + \text{moles C}_2\text{H}_5\text{Cl} = 1.371365 \text{ mol} + 2.193695 \text{ mol} + 1.371365 \text{ mol} \\ = 4.936425 = \mathbf{4.94 \text{ mol total}}$$

- 4.88 Plan: Write balanced equations for the reaction of CO<sub>2</sub> with the various metal hydroxides. Convert the mass of metal hydroxide to moles by dividing by the molar mass; use the mole ratio in the balanced equation to find the moles and then mass of CO<sub>2</sub> required to react with the metal hydroxide.

Solution:

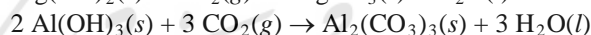
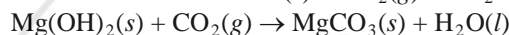
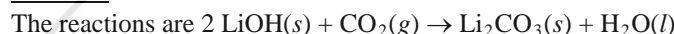

$$\text{a) Mass (g) of CO}_2 = (3.50 \text{ kg LiOH}) \left( \frac{10^3 \text{ g}}{1 \text{ kg}} \right) \left( \frac{1 \text{ mol LiOH}}{23.95 \text{ g LiOH}} \right) \left( \frac{1 \text{ mol CO}_2}{2 \text{ mol LiOH}} \right) \left( \frac{44.01 \text{ g CO}_2}{1 \text{ mol CO}_2} \right) \\ = 3215.762 = \mathbf{3.22 \times 10^3 \text{ g CO}_2}$$

b) Mass CO<sub>2</sub> absorbed by 1.00 g LiOH:

$$\text{Mass (g)} = (1.00 \text{ g LiOH}) \left( \frac{1 \text{ mol LiOH}}{23.95 \text{ g LiOH}} \right) \left( \frac{1 \text{ mol CO}_2}{2 \text{ mol LiOH}} \right) \left( \frac{44.01 \text{ g CO}_2}{1 \text{ mol CO}_2} \right) \\ = 0.918789 = \mathbf{0.919 \text{ g CO}_2}$$

Mass CO<sub>2</sub> absorbed by 1.00 g Mg(OH)<sub>2</sub>:

$$\text{Mass (g)} = (1.00 \text{ g Mg(OH)}_2) \left( \frac{1 \text{ mol Mg(OH)}_2}{58.33 \text{ g Mg(OH)}_2} \right) \left( \frac{1 \text{ mol CO}_2}{1 \text{ mol Mg(OH)}_2} \right) \left( \frac{44.01 \text{ g CO}_2}{1 \text{ mol CO}_2} \right) \\ = 0.75450 = \mathbf{0.754 \text{ g CO}_2}$$

Mass CO<sub>2</sub> absorbed by 1.00 g Al(OH)<sub>3</sub>:

$$\text{Mass (g)} = (1.00 \text{ g Al(OH)}_3) \left( \frac{1 \text{ mol Al(OH)}_3}{78.00 \text{ g Al(OH)}_3} \right) \left( \frac{3 \text{ mol CO}_2}{2 \text{ mol Al(OH)}_3} \right) \left( \frac{44.01 \text{ g CO}_2}{1 \text{ mol CO}_2} \right) \\ = 0.846346 = \mathbf{0.846 \text{ g CO}_2}$$

- 4.89 Plan: Balance the equation to obtain the correct molar ratios. Use the mass percents to find the mass of each reactant in a 1.00 g sample, convert the mass of each reactant to moles, and use the molar ratios to find the limiting reactant and the amount of CO<sub>2</sub> produced. Convert moles of CO<sub>2</sub> produced to volume using the given conversion factor.

Solution:

a) Here is a suggested method for balancing the equation.

— Since PO<sub>4</sub><sup>2-</sup> remains as a unit on both sides of the equation, treat it as a unit when balancing.

— On first inspection, one can see that Na needs to be balanced by adding a “2” in front of NaHCO<sub>3</sub>. This then affects the balance of C, so add a “2” in front of CO<sub>2</sub>.

— Hydrogen is not balanced, so change the coefficient of water to “2,” as this will have the least impact on the other species.

— Verify that the other species are balanced.

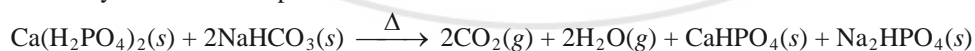

Determine whether Ca(H<sub>2</sub>PO<sub>4</sub>)<sub>2</sub> or NaHCO<sub>3</sub> limits the production of CO<sub>2</sub>. In each case calculate the moles of CO<sub>2</sub> that might form.

$$\text{Mass (g) of NaHCO}_3 = (1.00 \text{ g}) \left( \frac{31.0\%}{100\%} \right) = 0.31 \text{ g NaHCO}_3$$



$$\text{Mass (g) of Ca(H}_2\text{PO}_4)_2 = (1.00 \text{ g}) \left( \frac{35.0\%}{100\%} \right) = 0.35 \text{ g Ca(H}_2\text{PO}_4)_2$$

$$\begin{aligned} \text{Moles of CO}_2 \text{ if NaHCO}_3 \text{ is limiting} &= (0.31 \text{ g NaHCO}_3) \left( \frac{1 \text{ mol NaHCO}_3}{84.01 \text{ g NaHCO}_3} \right) \left( \frac{2 \text{ mol CO}_2}{2 \text{ mol NaHCO}_3} \right) \\ &= 3.690 \times 10^{-3} \text{ mol CO}_2 \end{aligned}$$

$$\begin{aligned} \text{Moles of CO}_2 \text{ if Ca(H}_2\text{PO}_4)_2 \text{ is limiting} &= (0.35 \text{ g Ca(H}_2\text{PO}_4)_2) \left( \frac{1 \text{ mol Ca(H}_2\text{PO}_4)_2}{234.05 \text{ g Ca(H}_2\text{PO}_4)_2} \right) \left( \frac{2 \text{ mol CO}_2}{1 \text{ mol Ca(H}_2\text{PO}_4)_2} \right) \\ &= 2.9908 \times 10^{-3} \text{ mol CO}_2 \end{aligned}$$

Since  $\text{Ca(H}_2\text{PO}_4)_2$  produces the smaller amount of product, it is the limiting reactant and  $3.0 \times 10^{-3} \text{ mol CO}_2$  will be produced.

$$\text{b) Volume (L) of CO}_2 = (2.9908 \times 10^{-3} \text{ mol CO}_2) \left( \frac{37.0 \text{ L}}{1 \text{ mol CO}_2} \right) = 0.1106596 = \mathbf{0.11 \text{ L CO}_2}$$

- 4.90 **Plan:** Write a balanced acid-base reaction. Find the total moles of NaOH used by multiplying its molarity and volume in liters and use the molar ratio in the reaction to find the moles of  $\text{HNO}_3$ . Divide moles of  $\text{HNO}_3$  by its volume to obtain the molarity. Use the molarity and volume information to find the moles of NaOH initially added and the moles of  $\text{HNO}_3$  initially present. The difference of these two values is the moles of excess NaOH.

**Solution:**

The chemical equation is:

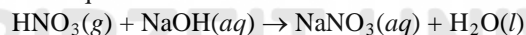

- a) It takes a total of  $(20.00 + 3.22) \text{ mL} = 23.22 \text{ mL NaOH}$  to titrate a total of  $(50.00 + 30.00) \text{ mL} = 80.00 \text{ mL}$  of acid.

$$\text{Moles of NaOH} = (23.22 \text{ mL}) \left( \frac{10^{-3} \text{ L}}{1 \text{ mL}} \right) \left( \frac{0.0502 \text{ mol NaOH}}{\text{L}} \right) = 0.0011656 \text{ mol NaOH}$$

$$\text{Moles of HNO}_3 = (0.0011656 \text{ mol NaOH}) \left( \frac{1 \text{ mol HNO}_3}{1 \text{ mol NaOH}} \right) = 0.0011656 \text{ mol HNO}_3$$

$$\text{Molarity of HNO}_3 = (0.0011656 \text{ mol HNO}_3) \left( \frac{1}{80.00 \text{ mL}} \right) \left( \frac{1 \text{ mL}}{10^{-3} \text{ L}} \right) = 0.01457055 = \mathbf{0.0146 \text{ M HNO}_3}$$

- b) First calculate the moles of the acid and base initially present. The difference will give the excess NaOH.

$$\text{Moles of NaOH} = (20.00 \text{ mL}) \left( \frac{10^{-3} \text{ L}}{1 \text{ mL}} \right) \left( \frac{0.0502 \text{ mol NaOH}}{\text{L}} \right) = 1.004 \times 10^{-3} \text{ mol NaOH}$$

$$\text{Moles of HNO}_3 = (50.00 \text{ mL}) \left( \frac{10^{-3} \text{ L}}{1 \text{ mL}} \right) \left( \frac{0.01457055 \text{ mol HNO}_3}{\text{L}} \right) = 7.285275 \times 10^{-4} \text{ mol HNO}_3$$

$$\text{Moles of NaOH required to titrate } 7.285275 \times 10^{-4} \text{ mol HNO}_3 = 7.285275 \times 10^{-4} \text{ mol NaOH}$$

$$\text{Moles excess NaOH} = \text{moles of added NaOH} - \text{moles of NaOH required for reaction}$$

$$= 1.004 \times 10^{-3} \text{ mol NaOH} - 7.285275 \times 10^{-4} \text{ mol NaOH}$$

$$= 2.754725 \times 10^{-4} = \mathbf{2.8 \times 10^{-4} \text{ mol NaOH}}$$

- 4.91 **Plan:** To determine the empirical formula, find the moles of each element present and divide by the smallest number of moles to get the smallest ratio of atoms. To find the molecular formula, divide the molar mass by the mass of the empirical formula to find the factor by which to multiple the empirical formula. Write the balanced acid-base reaction for part c) and use the molar ratio in that reaction to find the mass of bismuth(III) hydroxide.

**Solution:**

- a) Determine the moles of each element present. The sample was burned in an unknown amount of  $\text{O}_2$ , therefore, the moles of oxygen must be found by a different method.

$$\text{Moles of C} = (0.1880 \text{ g CO}_2) \left( \frac{1 \text{ mol CO}_2}{44.01 \text{ g CO}_2} \right) \left( \frac{1 \text{ mol C}}{1 \text{ mol CO}_2} \right) = 4.271756 \times 10^{-3} \text{ mol C}$$

$$\text{Moles of H} = (0.02750 \text{ g H}_2\text{O}) \left( \frac{1 \text{ mol H}_2\text{O}}{18.02 \text{ g H}_2\text{O}} \right) \left( \frac{2 \text{ mol H}}{1 \text{ mol H}_2\text{O}} \right) = 3.052164 \times 10^{-3} \text{ mol H}$$

$$\text{Moles of Bi} = (0.1422 \text{ g Bi}_2\text{O}_3) \left( \frac{1 \text{ mol Bi}_2\text{O}_3}{466.0 \text{ g Bi}_2\text{O}_3} \right) \left( \frac{2 \text{ mol Bi}}{1 \text{ mol Bi}_2\text{O}_3} \right) = 6.103004 \times 10^{-4} \text{ mol Bi}$$

Subtracting the mass of each element present from the mass of the sample will give the mass of oxygen originally present in the sample. This mass is used to find the moles of oxygen.

$$\text{Mass (g) of C} = (4.271756 \times 10^{-3} \text{ mol C}) \left( \frac{12.01 \text{ g C}}{1 \text{ mol C}} \right) = 0.0513038 \text{ g C}$$

$$\text{Mass (g) of H} = (3.052164 \times 10^{-3} \text{ mol H}) \left( \frac{1.008 \text{ g H}}{1 \text{ mol H}} \right) = 0.0030766 \text{ g H}$$

$$\text{Mass (g) of Bi} = (6.103004 \times 10^{-4} \text{ mol Bi}) \left( \frac{209.0 \text{ g Bi}}{1 \text{ mol Bi}} \right) = 0.127553 \text{ g Bi}$$

$$\begin{aligned} \text{Mass (g) of O} &= \text{mass of sample} - (\text{mass C} + \text{mass H} + \text{mass Bi}) \\ &= 0.22105 \text{ g sample} - (0.0513038 \text{ g C} + 0.0030766 \text{ g H} + 0.127553 \text{ g Bi}) = 0.0391166 \text{ g O} \end{aligned}$$

$$\text{Moles of O} = (0.0391166 \text{ g O}) \left( \frac{1 \text{ mol O}}{16.00 \text{ g O}} \right) = 2.44482 \times 10^{-4} \text{ mol O}$$

Divide each of the moles by the smallest value (moles Bi).

$$\text{C} = \frac{4.271756 \times 10^{-3}}{6.103004 \times 10^{-4}} = 7 \qquad \text{H} = \frac{3.052164 \times 10^{-3}}{6.103004 \times 10^{-4}} = 5$$

$$\text{O} = \frac{2.4448 \times 10^{-3}}{6.103004 \times 10^{-4}} = 4 \qquad \text{Bi} = \frac{6.103004 \times 10^{-4}}{6.103004 \times 10^{-4}} = 1$$

Empirical formula = **C<sub>7</sub>H<sub>5</sub>O<sub>4</sub>Bi**

b) The empirical formula mass is 362 g/mol. Therefore, there are  $1086/362 = 3$  empirical formula units per molecular formula making the molecular formula =  $3 \times \text{C}_7\text{H}_5\text{O}_4\text{Bi} = \text{C}_{21}\text{H}_{15}\text{O}_{12}\text{Bi}_3$ .

c)  $\text{Bi}(\text{OH})_3(s) + 3\text{HC}_7\text{H}_5\text{O}_3(aq) \rightarrow \text{Bi}(\text{C}_7\text{H}_5\text{O}_3)_3(s) + 3\text{H}_2\text{O}(l)$

$$\begin{aligned} \text{d) Moles of C}_{21}\text{H}_{15}\text{O}_{12}\text{Bi}_3 &= (0.600 \text{ mg C}_{21}\text{H}_{15}\text{O}_{12}\text{Bi}_3) \left( \frac{10^{-3} \text{ g}}{1 \text{ mg}} \right) \left( \frac{1 \text{ mol C}_{21}\text{H}_{15}\text{O}_{12}\text{Bi}_3}{1086 \text{ g C}_{21}\text{H}_{15}\text{O}_{12}\text{Bi}_3} \right) \\ &= 5.52486 \times 10^{-4} \text{ mol C}_{21}\text{H}_{15}\text{O}_{12}\text{Bi}_3 \end{aligned}$$

Mass (mg) of  $\text{Bi}(\text{OH})_3 =$

$$\begin{aligned} &(5.52486 \times 10^{-7} \text{ mol C}_{21}\text{H}_{15}\text{O}_{12}\text{Bi}_3) \left( \frac{3 \text{ mol Bi}}{1 \text{ mol C}_{21}\text{H}_{15}\text{O}_{12}\text{Bi}_3} \right) \left( \frac{1 \text{ mol Bi}(\text{OH})_3}{1 \text{ mol Bi}} \right) \left( \frac{260.0 \text{ g Bi}(\text{OH})_3}{1 \text{ mol Bi}(\text{OH})_3} \right) \left( \frac{1 \text{ mg}}{10^{-3} \text{ g}} \right) \left( \frac{100\%}{88.0\%} \right) \\ &= 0.48970 = \mathbf{0.490 \text{ mg Bi}(\text{OH})_3} \end{aligned}$$

4.92 **Plan:** Use the solubility rules to predict the products of this reaction. For the total ionic equation, write all soluble ionic substances as dissociated ions. Ions not involved in the precipitate are spectator ions and are not included in the net ionic equation. Find the moles of dissolved ions and divide each by the volume in liters to find the concentration. The volume of the final solution is the sum of the volumes of the two reactant solutions.

**Solution:**

a) According to the solubility rules, all chloride compounds are soluble and most common carbonate compounds are insoluble.  $\text{CaCO}_3$  is the precipitate.

Molecular equation:  $\text{Na}_2\text{CO}_3(aq) + \text{CaCl}_2(aq) \rightarrow \text{CaCO}_3(s) + 2\text{NaCl}(aq)$

Total ionic equation:  $2\text{Na}^+(aq) + \text{CO}_3^{2-}(aq) + \text{Ca}^{2+}(aq) + 2\text{Cl}^-(aq) \rightarrow \text{CaCO}_3(s) + 2\text{Na}^+(aq) + 2\text{Cl}^-(aq)$

Net ionic equation:  $\text{CO}_3^{2-}(aq) + \text{Ca}^{2+}(aq) \rightarrow \text{CaCO}_3(s)$

b)  $\text{Ca}^{2+}$  and  $\text{CO}_3^{2-}$  combine in a 1:1 ratio in  $\text{CaCO}_3$ . There are two spheres of  $\text{Ca}^{2+}$  and three spheres of  $\text{CO}_3^{2-}$

ion. Since there are fewer spheres of  $\text{Ca}^{2+}$ ,  $\text{Ca}^{2+}$  is the limiting reactant.

$$\begin{aligned} \text{Mass of CaCO}_3 &= \left(2 \text{ Ca}^{2+} \text{ spheres}\right) \left(\frac{0.050 \text{ mol Ca}^{2+}}{1 \text{ sphere}}\right) \left(\frac{1 \text{ mol CaCO}_3}{1 \text{ mol Ca}^{2+}}\right) \left(\frac{100.09 \text{ g CaCO}_3}{1 \text{ mol CaCO}_3}\right) \\ &= 10.009 = \mathbf{10. \text{ g CaCO}_3} \end{aligned}$$

c) Original moles:

$$\text{Moles of Na}^+ = \left(6 \text{ Na}^+ \text{ spheres}\right) \left(\frac{0.050 \text{ mol Na}^+}{1 \text{ sphere}}\right) = 0.30 \text{ mol Na}^+$$

$$\text{Moles of CO}_3^{2-} = \left(3 \text{ CO}_3^{2-} \text{ spheres}\right) \left(\frac{0.050 \text{ mol CO}_3^{2-}}{1 \text{ sphere}}\right) = 0.15 \text{ mol CO}_3^{2-}$$

$$\text{Moles of Ca}^{2+} = \left(2 \text{ Ca}^{2+} \text{ spheres}\right) \left(\frac{0.050 \text{ mol Ca}^{2+}}{1 \text{ sphere}}\right) = 0.10 \text{ mol Ca}^{2+}$$

$$\text{Moles of Cl}^- = \left(4 \text{ Cl}^- \text{ spheres}\right) \left(\frac{0.050 \text{ mol Cl}^-}{1 \text{ sphere}}\right) = 0.20 \text{ mol Cl}^-$$

The moles of  $\text{Na}^+$  and  $\text{Cl}^-$  do not change. The moles of  $\text{Ca}^{2+}$  goes to zero, and removes 0.10 mol of  $\text{CO}_3^{2-}$ .

Moles of remaining  $\text{CO}_3^{2-} = 0.15 \text{ mol CO}_3^{2-} - 0.10 \text{ mol} = 0.050 \text{ mol CO}_3^{2-}$

Volume of final solution = 250. mL + 250. mL = 500. mL

$$\text{Molarity of Na}^+ = \frac{0.30 \text{ mol}}{500. \text{ mL}} \left(\frac{1 \text{ mL}}{10^{-3} \text{ L}}\right) = \mathbf{0.60 \text{ M Na}^+}$$

$$\text{Molarity of Cl}^- = \frac{0.20 \text{ mol}}{500. \text{ mL}} \left(\frac{1 \text{ mL}}{10^{-3} \text{ L}}\right) = \mathbf{0.40 \text{ M Cl}^-}$$

$$\text{Molarity of CO}_3^{2-} = \frac{0.050 \text{ mol}}{500. \text{ mL}} \left(\frac{1 \text{ mL}}{10^{-3} \text{ L}}\right) = \mathbf{0.10 \text{ M CO}_3^{2-}}$$

- 4.93 Plan: Write balanced equations. Use the density to convert volume of fuel to mass of fuel and then use the molar ratios to convert mass of each fuel to the mass of oxygen required for the reaction. Use the conversion factor given to convert mass of oxygen to volume of oxygen.

Solution:

a) Complete combustion of hydrocarbons involves heating the hydrocarbon in the presence of oxygen to produce carbon dioxide and water.

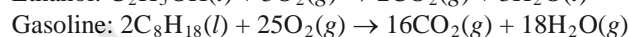
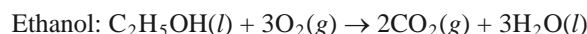

b) The mass of each fuel must be found:

$$\text{Mass (g) of gasoline} = (1.00 \text{ L}) \left(\frac{90\%}{100\%}\right) \left(\frac{1 \text{ mL}}{10^{-3} \text{ L}}\right) \left(\frac{0.742 \text{ g}}{1 \text{ mL}}\right) = 667.8 \text{ g gasoline}$$

$$\text{Mass (g) of ethanol} = (1.00 \text{ L}) \left(\frac{10\%}{100\%}\right) \left(\frac{1 \text{ mL}}{10^{-3} \text{ L}}\right) \left(\frac{0.789 \text{ g}}{1 \text{ mL}}\right) = 78.9 \text{ g ethanol}$$

$$\begin{aligned} \text{Mass (g) of O}_2 \text{ to react with gasoline} &= (667.8 \text{ g C}_8\text{H}_{18}) \left(\frac{1 \text{ mol C}_8\text{H}_{18}}{114.22 \text{ g C}_8\text{H}_{18}}\right) \left(\frac{25 \text{ mol O}_2}{2 \text{ mol C}_8\text{H}_{18}}\right) \left(\frac{32.00 \text{ g O}_2}{1 \text{ mol O}_2}\right) \\ &= 2338.64 \text{ g O}_2 \end{aligned}$$

$$\begin{aligned} \text{Mass (g) of O}_2 \text{ to react with ethanol} &= (78.9 \text{ g C}_2\text{H}_5\text{OH}) \left(\frac{1 \text{ mol C}_2\text{H}_5\text{OH}}{46.07 \text{ g C}_2\text{H}_5\text{OH}}\right) \left(\frac{3 \text{ mol O}_2}{1 \text{ mol C}_2\text{H}_5\text{OH}}\right) \left(\frac{32.00 \text{ g O}_2}{1 \text{ mol O}_2}\right) \\ &= 164.41 \text{ g O}_2 \end{aligned}$$

$$\text{Total mass (g) of O}_2 = 2338.64 \text{ g O}_2 + 164.41 \text{ g O}_2 = 2503.05 = \mathbf{2.50 \times 10^3 \text{ g O}_2}$$

$$\text{c) Volume (L) of O}_2 = (2503.05 \text{ g O}_2) \left( \frac{1 \text{ mol O}_2}{32.00 \text{ g O}_2} \right) \left( \frac{22.4 \text{ L}}{1 \text{ mol O}_2} \right) = 1752.135 = \mathbf{1.75 \times 10^3 \text{ L O}_2}$$

$$\text{d) Volume (L) of air} = (1752.135 \text{ L O}_2) \left( \frac{100\%}{20.9\%} \right) = 8383.42 = \mathbf{8.38 \times 10^3 \text{ L air}}$$

4.94 Plan: Write balanced reactions for the complete combustion of gasoline and for the incomplete combustion. Use molar ratios to find the moles of CO<sub>2</sub> and moles of CO produced. Obtain the number of molecules of each gas by multiplying moles by Avogadro's number.

Solution:

a) Complete combustion: 1.  $2\text{C}_8\text{H}_{18}(l) + 25\text{O}_2(g) \rightarrow 16\text{CO}_2(g) + 18\text{H}_2\text{O}(g)$

Incomplete combustion: 2.  $2\text{C}_8\text{H}_{18}(l) + 17\text{O}_2(g) \rightarrow 16\text{CO}(g) + 18\text{H}_2\text{O}(g)$

Assuming a 100-g sample of gasoline, 95%, or 95.0 g, will react by equation 1, and 5.0%, or 5.0 g, will react by equation 2.

$$\begin{aligned} \text{Molecules of CO}_2 &= (95.0 \text{ g C}_8\text{H}_{18}) \left( \frac{1 \text{ mol C}_8\text{H}_{18}}{114.22 \text{ g C}_8\text{H}_{18}} \right) \left( \frac{16 \text{ mol CO}_2}{2 \text{ mol C}_8\text{H}_{18}} \right) \left( \frac{6.022 \times 10^{23} \text{ CO}_2}{1 \text{ mol CO}_2} \right) \\ &= 4.00693 \times 10^{24} \text{ molecules CO}_2 \end{aligned}$$

$$\begin{aligned} \text{Molecules of CO} &= (5.0 \text{ g C}_8\text{H}_{18}) \left( \frac{1 \text{ mol C}_8\text{H}_{18}}{114.22 \text{ g C}_8\text{H}_{18}} \right) \left( \frac{16 \text{ mol CO}}{2 \text{ mol C}_8\text{H}_{18}} \right) \left( \frac{6.022 \times 10^{23} \text{ CO}}{1 \text{ mol CO}} \right) \\ &= 2.10891 \times 10^{23} \text{ molecules CO} \end{aligned}$$

$$\text{Ratio of CO}_2 \text{ to CO molecules} = \frac{4.00693 \times 10^{24} \text{ CO}_2 \text{ molecules}}{2.10891 \times 10^{23} \text{ CO molecules}} = 18.99998 = \mathbf{19}$$

b) Again, we may assume 100 g of gasoline.

$$\begin{aligned} \text{Mass (g) of CO}_2 &= (95.0 \text{ g C}_8\text{H}_{18}) \left( \frac{1 \text{ mol C}_8\text{H}_{18}}{114.22 \text{ g C}_8\text{H}_{18}} \right) \left( \frac{16 \text{ mol CO}_2}{2 \text{ mol C}_8\text{H}_{18}} \right) \left( \frac{44.01 \text{ g CO}_2}{1 \text{ mol CO}_2} \right) \\ &= 292.83 \text{ g CO}_2 \end{aligned}$$

$$\text{Mass (g) of CO} = (5.0 \text{ g C}_8\text{H}_{18}) \left( \frac{1 \text{ mol C}_8\text{H}_{18}}{114.22 \text{ g C}_8\text{H}_{18}} \right) \left( \frac{16 \text{ mol CO}}{2 \text{ mol C}_8\text{H}_{18}} \right) \left( \frac{28.01 \text{ g CO}}{1 \text{ mol CO}} \right) = 9.8091 \text{ g CO}$$

$$\text{Mass ratio of CO}_2 \text{ to CO} = \frac{292.83 \text{ g CO}_2}{9.8091 \text{ g CO}} = 29.85289 = \mathbf{30}$$

c) Let  $x$  = fraction of CO<sub>2</sub> and  $y$  = fraction of CO. For a 1/1 mass ratio of CO<sub>2</sub> to CO,  $\frac{(x)(44.01)}{y(28.01)} = 1$ , where

44.01 g/mol is the molar mass of CO<sub>2</sub> and 28.01 g/mol is the molar mass of CO.  $x + y = 1$  or  $y = 1 - x$

$$\text{Substituting: } \frac{(x)(44.01)}{(1-x)(28.01)} = 1$$

$$44.01x = 28.01 - 28.01x$$

$$72.02x = 28.01$$

$$x = 0.39 \text{ and } y = 1 - 0.39 = 0.61$$

Thus, **61%** of the gasoline must form CO.

4.95 Plan: From the molarity and volume of the base NaOH, find the moles of NaOH and use the molar ratios from the two balanced equations to convert the moles of NaOH to moles of HBr to moles of vitamin C. Use the molar mass of vitamin C to convert moles to grams.

Solution:

$$\text{Moles of NaOH} = (43.20 \text{ mL NaOH}) \left( \frac{10^{-3} \text{ L}}{1 \text{ mL}} \right) \left( \frac{0.1350 \text{ mol NaOH}}{1 \text{ L}} \right) = 0.005832 \text{ mol NaOH}$$

$$\text{Mass (g) of vitamin C} = (0.005832 \text{ mol NaOH}) \left( \frac{1 \text{ mol HBr}}{1 \text{ mol NaOH}} \right) \left( \frac{1 \text{ mol C}_6\text{H}_8\text{O}_6}{2 \text{ mol HBr}} \right) \left( \frac{176.12 \text{ g C}_6\text{H}_8\text{O}_6}{1 \text{ mol C}_6\text{H}_8\text{O}_6} \right) \left( \frac{1 \text{ mg}}{10^{-3} \text{ g}} \right)$$

$$= 513.5659 = 513.6 \text{ mg C}_6\text{H}_8\text{O}_6$$

Yes, the tablets have the quantity advertised.

- 4.96 Plan: Remember that oxidation numbers change in a redox reaction. For the calculations, use the molarity and volume of HCl to find the moles of HCl and use the molar ratios from the balanced equation to convert moles of HCl to moles and then grams of the desired substance.

Solution:

a) The **second reaction is a redox process** because the O.N. of iron changes from 0 to +2 (it oxidizes) while the O.N. of hydrogen changes from +1 to 0 (it reduces).

b) Determine the moles of HCl present and use the balanced chemical equation to determine the appropriate quantities.

$$\text{Mass Fe}_2\text{O}_3 = (2.50 \times 10^3 \text{ L}) \left( \frac{3.00 \text{ mol HCl}}{\text{L}} \right) \left( \frac{1 \text{ mol Fe}_2\text{O}_3}{6 \text{ mol HCl}} \right) \left( \frac{159.70 \text{ g Fe}_2\text{O}_3}{1 \text{ mol Fe}_2\text{O}_3} \right)$$

$$= 199,625 = \mathbf{2.00 \times 10^5 \text{ g Fe}_2\text{O}_3}$$

$$\text{Mass FeCl}_3 = (2.50 \times 10^3 \text{ L}) \left( \frac{3.00 \text{ mol HCl}}{\text{L}} \right) \left( \frac{2 \text{ mol FeCl}_3}{6 \text{ mol HCl}} \right) \left( \frac{162.20 \text{ g FeCl}_3}{1 \text{ mol FeCl}_3} \right)$$

$$= 405,500 = \mathbf{4.06 \times 10^5 \text{ g FeCl}_3}$$

c) Use reaction 2 like reaction 1 was used in part b.

$$\text{Mass Fe} = (2.50 \times 10^3 \text{ L}) \left( \frac{3.00 \text{ mol HCl}}{\text{L}} \right) \left( \frac{1 \text{ mol Fe}}{2 \text{ mol HCl}} \right) \left( \frac{55.85 \text{ g Fe}}{1 \text{ mol Fe}} \right)$$

$$= 209,437.5 = \mathbf{2.09 \times 10^5 \text{ g Fe}}$$

$$\text{Mass FeCl}_2 = (2.50 \times 10^3 \text{ L}) \left( \frac{3.00 \text{ mol HCl}}{\text{L}} \right) \left( \frac{1 \text{ mol FeCl}_2}{2 \text{ mol HCl}} \right) \left( \frac{126.75 \text{ g FeCl}_2}{1 \text{ mol FeCl}_2} \right)$$

$$= 475,312.5 = \mathbf{4.75 \times 10^5 \text{ g FeCl}_2}$$

d) Use 1.00 g Fe<sub>2</sub>O<sub>3</sub> to determine the mass of FeCl<sub>3</sub> formed (reaction 1), and 0.280 g Fe to determine the mass of FeCl<sub>2</sub> formed (reaction 2).

$$\text{Mass FeCl}_3 = (1.00 \text{ g Fe}_2\text{O}_3) \left( \frac{1 \text{ mol Fe}_2\text{O}_3}{159.70 \text{ g Fe}_2\text{O}_3} \right) \left( \frac{2 \text{ mol FeCl}_3}{1 \text{ mol Fe}_2\text{O}_3} \right) \left( \frac{162.20 \text{ g FeCl}_3}{1 \text{ mol FeCl}_3} \right)$$

$$= 2.0313 \text{ g FeCl}_3 \text{ (unrounded)}$$

$$\text{Mass FeCl}_2 = (0.280 \text{ g Fe}) \left( \frac{1 \text{ mol Fe}}{55.85 \text{ g Fe}} \right) \left( \frac{1 \text{ mol FeCl}_2}{1 \text{ mol Fe}} \right) \left( \frac{126.75 \text{ g FeCl}_2}{1 \text{ mol FeCl}_2} \right)$$

$$= 0.635452 \text{ g FeCl}_2 \text{ (unrounded)}$$

$$\text{Ratio} = (0.635452 \text{ g FeCl}_2) / (2.0313 \text{ g FeCl}_3) = 0.312830 = \mathbf{0.313}$$

- 4.97 Plan: For part a), assign oxidation numbers to each element. The reactant that is the reducing agent contains an atom that is oxidized (O.N. increases from the left side to the right side of the equation). The reactant that is the oxidizing agent contains an atom that is reduced (O.N. decreases from the left side to the right side of the equation). Use the molar ratios in the balanced equation to convert mass of ammonium perchlorate to moles of product and to moles of Al required in the reaction. Use the density values to convert masses to volumes.

**Solution:**

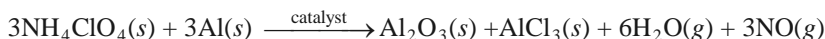
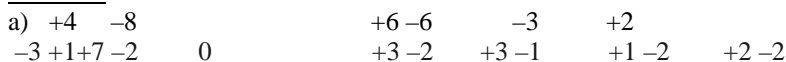

The O.N. of chlorine decreases from +7 in  $\text{NH}_4\text{ClO}_4$  to -1 in  $\text{AlCl}_3$  and is reduced; the O.N. of Al increases from 0 in Al to +3 in the products and is oxidized. The **oxidizing agent is ammonium perchlorate and the reducing agent is aluminum.**

b) Moles of gas =  $(50.0 \text{ kg NH}_4\text{ClO}_4) \left( \frac{10^3 \text{ g}}{1 \text{ kg}} \right) \left( \frac{1 \text{ mol NH}_4\text{ClO}_4}{117.49 \text{ g NH}_4\text{ClO}_4} \right) \left( \frac{9 \text{ mol gas}}{3 \text{ mol NH}_4\text{ClO}_4} \right)$   
 $= 1276.70 = 1.28 \times 10^3 \text{ mol gas}$

c) Initial volume:

$$\text{Volume (L) of NH}_4\text{ClO}_4 = (50.0 \text{ kg}) \left( \frac{10^3 \text{ g}}{1 \text{ kg}} \right) \left( \frac{1 \text{ cc}}{1.95 \text{ g}} \right) \left( \frac{1 \text{ mL}}{1 \text{ cc}} \right) \left( \frac{10^{-3} \text{ L}}{1 \text{ mL}} \right) = 25.6410 \text{ L}$$

$$\text{Mass of Al} = (50.0 \text{ kg NH}_4\text{ClO}_4) \left( \frac{10^3 \text{ g}}{1 \text{ kg}} \right) \left( \frac{1 \text{ mol NH}_4\text{ClO}_4}{117.49 \text{ g NH}_4\text{ClO}_4} \right) \left( \frac{3 \text{ mol Al}}{3 \text{ mol NH}_4\text{ClO}_4} \right) \left( \frac{26.98 \text{ g Al}}{1 \text{ mol Al}} \right) = 11481.828 \text{ g Al}$$

$$\text{Volume (L) of Al} = (11481.828 \text{ g Al}) \left( \frac{1 \text{ cc}}{2.70 \text{ g Al}} \right) \left( \frac{1 \text{ mL}}{1 \text{ cc}} \right) \left( \frac{10^{-3} \text{ L}}{1 \text{ mL}} \right) = 4.2525 \text{ L}$$

$$\text{Initial volume} = 25.6410 \text{ L} + 4.2525 \text{ L} = 29.8935 \text{ L}$$

Final volume:

$$\text{Mass (g) of Al}_2\text{O}_3 = (50.0 \text{ kg NH}_4\text{ClO}_4) \left( \frac{10^3 \text{ g}}{1 \text{ kg}} \right) \left( \frac{1 \text{ mol NH}_4\text{ClO}_4}{117.49 \text{ g NH}_4\text{ClO}_4} \right) \left( \frac{1 \text{ mol Al}_2\text{O}_3}{3 \text{ mol NH}_4\text{ClO}_4} \right) \left( \frac{101.96 \text{ g Al}_2\text{O}_3}{1 \text{ mol Al}_2\text{O}_3} \right)$$
$$= 14463.64 \text{ g Al}_2\text{O}_3$$

$$\text{Volume (L) of Al}_2\text{O}_3 = (14463.674 \text{ g Al}_2\text{O}_3) \left( \frac{1 \text{ cc}}{3.97 \text{ g Al}_2\text{O}_3} \right) \left( \frac{1 \text{ mL}}{1 \text{ cc}} \right) \left( \frac{10^{-3} \text{ L}}{1 \text{ mL}} \right) = 3.6432 \text{ L}$$

$$\text{Mass (g) of AlCl}_3 = (50.0 \text{ kg NH}_4\text{ClO}_4) \left( \frac{10^3 \text{ g}}{1 \text{ kg}} \right) \left( \frac{1 \text{ mol NH}_4\text{ClO}_4}{117.49 \text{ g NH}_4\text{ClO}_4} \right) \left( \frac{1 \text{ mol AlCl}_3}{3 \text{ mol NH}_4\text{ClO}_4} \right) \left( \frac{133.33 \text{ g AlCl}_3}{1 \text{ mol AlCl}_3} \right)$$
$$= 18913.67 \text{ g AlCl}_3$$

$$\text{Volume (L) of AlCl}_3 = (18913.67 \text{ g AlCl}_3) \left( \frac{1 \text{ cc}}{2.44 \text{ g AlCl}_3} \right) \left( \frac{1 \text{ mL}}{1 \text{ cc}} \right) \left( \frac{10^{-3} \text{ L}}{1 \text{ mL}} \right) = 7.7515 \text{ L}$$

$$\text{Volume (L) of gas} = (1276.70 \text{ mol gas}) \left( \frac{22.4 \text{ L}}{1 \text{ mol gas}} \right) = 28598.08 \text{ L}$$

$$\text{Final volume} = 3.6432 \text{ L} + 7.7515 \text{ L} + 28598.08 \text{ L} = 28609.4747 \text{ L}$$

$$\text{Volume change} = \text{Final volume} - \text{initial volume} = (28609.4747 \text{ L}) - (29.8935 \text{ L}) = 28579.5812 = 2.86 \times 10^4 \text{ L}$$

The volumes of all solids (before and after) are insignificant.

# CHAPTER 5 GASES AND THE KINETIC-MOLECULAR THEORY

## END-OF-CHAPTER PROBLEMS

- 5.1 Plan: Review the behavior of the gas phase vs. the liquid phase.  
Solution:  
a) The volume of the liquid remains constant, but the volume of the gas increases to the volume of the larger container.  
b) The volume of the container holding the gas sample increases when heated, but the volume of the container holding the liquid sample remains essentially constant when heated.  
c) The volume of the liquid remains essentially constant, but the volume of the gas is reduced.
- 5.2 The particles in a gas are further apart than those are in a liquid.  
a) The greater empty space between gas molecules allows gases to be more compressible than liquids.  
b) The greater empty space between gas molecules allows gases to flow with less resistance (hindrance) than liquids.  
c) The large empty space between gas molecules limits their interaction, allowing all mixtures of gases to be solutions.  
d) The large empty space between gas molecules increases the volume of the gas, therefore decreasing the density.
- 5.3 The mercury column in the mercury barometer stays up due to the force exerted by the atmosphere on the mercury in the outer reservoir just balancing the gravitational force on the mercury in the tube. Its height adjusts according to the air pressure on the reservoir. The column of mercury is shorter on a mountaintop as there is less atmosphere to exert a force on the mercury reservoir. On a mountaintop, the air pressure is less, so the height of mercury it balances in the barometer is shorter than at sea level where there is more air pressure.
- 5.4 Plan: The ratio of the heights of columns of mercury and water are inversely proportional to the ratio of the densities of the two liquids. Convert the height in mm to height in cm.  
Solution:  
$$\frac{h_{\text{H}_2\text{O}}}{h_{\text{Hg}}} = \frac{d_{\text{Hg}}}{d_{\text{H}_2\text{O}}}$$
$$h_{\text{H}_2\text{O}} = \frac{d_{\text{Hg}}}{d_{\text{H}_2\text{O}}} \times h_{\text{Hg}} = \left(\frac{13.5 \text{ g/mL}}{1.00 \text{ g/mL}}\right)(730 \text{ mmHg})\left(\frac{10^{-3} \text{ m}}{1 \text{ mm}}\right)\left(\frac{1 \text{ cm}}{10^{-2} \text{ m}}\right) = 985.5 = \mathbf{990 \text{ cm H}_2\text{O}}$$
- 5.5 Plan: The ratio of the heights of columns of mercury and water are inversely proportional to the ratio of the densities of the two liquids.  
Solution:  
$$\frac{h_{\text{H}_2\text{O}}}{h_{\text{Hg}}} = \frac{d_{\text{Hg}}}{d_{\text{H}_2\text{O}}}$$
$$h_{\text{H}_2\text{O}} = \frac{d_{\text{Hg}}}{d_{\text{H}_2\text{O}}} \times h_{\text{Hg}} = \left(\frac{13.5 \text{ g/mL}}{1.00 \text{ g/mL}}\right)(755 \text{ mmHg}) = 10,192.5 = \mathbf{1.02 \times 10^4 \text{ mm H}_2\text{O}}$$
- 5.6 Plan: Use the conversion factors between pressure units:  
1 atm = 760 mmHg = 760 torr = 101.325 kPa = 1.01325 bar  
Solution:  
a) Converting from atm to mmHg:  $P(\text{mmHg}) = (0.745 \text{ atm})\left(\frac{760 \text{ mmHg}}{1 \text{ atm}}\right) = 566.2 = \mathbf{566 \text{ mmHg}}$

- b) Converting from torr to bar:  $P(\text{bar}) = (992 \text{ torr}) \left( \frac{1.01325 \text{ bar}}{760 \text{ torr}} \right) = 1.32256 = \mathbf{1.32 \text{ bar}}$
- c) Converting from kPa to atm:  $P(\text{atm}) = (365 \text{ kPa}) \left( \frac{1 \text{ atm}}{101.325 \text{ kPa}} \right) = 3.60227 = \mathbf{3.60 \text{ atm}}$
- d) Converting from mmHg to kPa:  $P(\text{kPa}) = (804 \text{ mmHg}) \left( \frac{101.325 \text{ kPa}}{760 \text{ mmHg}} \right) = 107.191 = \mathbf{107 \text{ kPa}}$

5.7 Plan: Use the conversion factors between pressure units:  
 $1 \text{ atm} = 760 \text{ mmHg} = 760 \text{ torr} = 101.325 \text{ kPa} = 1.01325 \text{ bar}$

Solution:

a) Converting from cmHg to atm:

$$P(\text{atm}) = (76.8 \text{ cmHg}) \left( \frac{10^{-2} \text{ m}}{1 \text{ cm}} \right) \left( \frac{1 \text{ mm}}{10^{-3} \text{ m}} \right) \left( \frac{1 \text{ atm}}{760 \text{ mmHg}} \right) = 1.01053 = \mathbf{1.01 \text{ atm}}$$

b) Converting from atm to kPa:  $P(\text{kPa}) = (27.5 \text{ atm}) \left( \frac{101.325 \text{ kPa}}{1 \text{ atm}} \right) = 2.786 \times 10^3 = \mathbf{2.79 \times 10^3 \text{ kPa}}$

c) Converting from atm to bar:  $P(\text{bar}) = (6.50 \text{ atm}) \left( \frac{1.01325 \text{ bar}}{1 \text{ atm}} \right) = 6.5861 = \mathbf{6.59 \text{ bar}}$

d) Converting from kPa to torr:  $P(\text{torr}) = (0.937 \text{ kPa}) \left( \frac{760 \text{ torr}}{101.325 \text{ kPa}} \right) = 7.02808 = \mathbf{7.03 \text{ torr}}$

5.8 Plan: Use the conversion factors between pressure units:  
 $1 \text{ atm} = 760 \text{ mmHg} = 760 \text{ torr} = 1.01325 \times 10^5 \text{ Pa} = 14.7 \text{ psi}$

Solution:

a) Converting from mmHg to atm:  $P(\text{atm}) = (2.75 \times 10^2 \text{ mmHg}) \left( \frac{1 \text{ atm}}{760 \text{ mmHg}} \right) = 0.361842 = \mathbf{0.362 \text{ atm}}$

b) Converting from psi to atm:  $P(\text{atm}) = (86 \text{ psi}) \left( \frac{1 \text{ atm}}{14.7 \text{ psi}} \right) = 5.85034 = \mathbf{5.9 \text{ atm}}$

c) Converting from Pa to atm:  $P(\text{atm}) = (9.15 \times 10^6 \text{ Pa}) \left( \frac{1 \text{ atm}}{1.01325 \times 10^5 \text{ Pa}} \right) = 90.303 = \mathbf{90.3 \text{ atm}}$

d) Converting from torr to atm:  $P(\text{atm}) = (2.54 \times 10^4 \text{ torr}) \left( \frac{1 \text{ atm}}{760 \text{ torr}} \right) = 33.42105 = \mathbf{33.4 \text{ atm}}$

5.9 Plan:  $1 \text{ atm} = 1.01325 \times 10^5 \text{ Pa} = 1.01325 \times 10^5 \text{ N/m}^2$ . So the force on  $1 \text{ m}^2$  of ocean is  $1.01325 \times 10^5 \text{ N}$  where  $1 \text{ N} = 1 \frac{\text{kg} \cdot \text{m}}{\text{s}^2}$ . Use  $F = mg$  to find the mass of the atmosphere in  $\text{kg/m}^2$  for part a). For part b), convert this mass to  $\text{g/cm}^2$  and use the density of osmium to find the height of this mass of osmium.

Solution:

a)  $F = mg$

$$1.01325 \times 10^5 \text{ N} = mg$$

$$1.01325 \times 10^5 \frac{\text{kg} \cdot \text{m}}{\text{s}^2} = (\text{mass}) (9.81 \text{ m/s}^2)$$

$$\text{mass} = 1.03287 \times 10^4 = \mathbf{1.03 \times 10^4 \text{ kg}}$$

b)  $\left( 1.03287 \times 10^4 \frac{\text{kg}}{\text{m}^2} \right) \left( \frac{10^3 \text{ g}}{1 \text{ kg}} \right) \left( \frac{10^{-2} \text{ m}}{1 \text{ cm}} \right)^2 = 1.03287 \times 10^3 \text{ g/cm}^2$



$$\text{Height (cm)} = \left( 1.03287 \times 10^3 \frac{\text{g}}{\text{cm}^2} \right) \left( \frac{1 \text{ mL}}{22.6 \text{ g}} \right) \left( \frac{1 \text{ cm}^3}{1 \text{ mL}} \right) = 45.702 = \mathbf{45.7 \text{ cm Os}}$$

5.10 The statement is incomplete with respect to temperature and mass of sample. The correct statement is: At constant temperature and moles of gas, the volume of gas is inversely proportional to the pressure.

- 5.11 a) Charles's law: At constant pressure, the volume of a fixed amount of gas is directly proportional to its Kelvin temperature. **Variable: volume and temperature; Fixed: pressure and moles**  
 b) Avogadro's law: At fixed temperature and pressure, the volume occupied by a gas is directly proportional to the moles of gas. **Variable: volume and moles; Fixed: temperature and pressure**  
 c) Amontons's law: At constant volume, the pressure exerted by a fixed amount of gas is directly proportional to the Kelvin temperature. **Variable: pressure and temperature; Fixed: volume and moles**

5.12 Plan: Examine the ideal gas law; volume and temperature are constant and pressure and moles are variable.

Solution:

$$PV = nRT \quad P = n \frac{RT}{V} \quad R, T, \text{ and } V \text{ are constant}$$

$$P = n \times \text{constant}$$

At constant temperature and volume, the pressure of the gas is directly proportional to the amount of gas in moles.

5.13 Plan: Examine the ideal gas law, noting the fixed variables and those variables that change.  $R$  is always constant

$$\text{so } \frac{P_1 V_1}{n_1 T_1} = \frac{P_2 V_2}{n_2 T_2}$$

Solution:

a)  $P$  is fixed; both  $V$  and  $T$  double:  $\frac{P_1 V_1}{n_1 T_1} = \frac{P_2 V_2}{n_2 T_2}$  or  $\frac{V_1}{n_1 T_1} = \frac{V_2}{n_2 T_2}$

$T$  can double as  $V$  doubles only if  $n$  is fixed.

b)  $T$  and  $n$  are both fixed and  $V$  doubles:  $\frac{P_1 V_1}{n_1 T_1} = \frac{P_2 V_2}{n_2 T_2}$  or  $P_1 V_1 = P_2 V_2$

$P$  and  $V$  are inversely proportional; as  $V$  doubles,  $P$  is halved.

c)  $T$  is fixed and  $V$  doubles.  $n$  doubles since one mole of reactant gas produces a total of 2 moles of product gas.

$$\frac{P_1 V_1}{n_1 T_1} = \frac{P_2 V_2}{n_2 T_2} \quad \text{or} \quad \frac{P_1 V_1}{n_1} = \frac{P_2 V_2}{n_2}$$

$V$  and  $n$  can both double only if  $P$  is fixed.

d)  $P$  is fixed and  $V$  doubles.  $n$  is fixed since 2 moles of reactant gas produce 2 moles of product gas.

$$\frac{P_1 V_1}{n_1 T_1} = \frac{P_2 V_2}{n_2 T_2} \quad \text{or} \quad \frac{V_1}{T_1} = \frac{V_2}{T_2}$$

$V$  and  $T$  are directly proportional so as  $V$  is doubled,  $T$  is doubled.

5.14 Plan: Use the relationship  $\frac{P_1 V_1}{n_1 T_1} = \frac{P_2 V_2}{n_2 T_2}$  or  $V_2 = \frac{P_1 V_1 n_2 T_2}{P_2 n_1 T_1}$ .

Solution:

a) As the pressure on a fixed amount of gas ( $n$  is fixed) increases at constant temperature ( $T$  is fixed), the molecules move closer together, decreasing the volume. When the pressure is tripled, the **volume decreases to one-third of the original volume** at constant temperature (Boyle's law).

$$V_2 = \frac{P_1 V_1 n_2 T_2}{P_2 n_1 T_1} = \frac{(P_1)(V_1)(1)(1)}{(3P_1)(1)(1)} \quad V_2 = \frac{1}{3} V_1$$

b) As the temperature of a fixed amount of gas ( $n$  is fixed) increases at constant pressure ( $P$  is fixed), the gas molecules gain kinetic energy. With higher energy, the gas molecules collide with the walls of the container with greater force, which increases the size (volume) of the container. If the temperature is increased by a factor of 3.0

(at constant pressure) then the **volume will increase by a factor of 3.0** (Charles's law).

$$V_2 = \frac{P_1 V_1 n_2 T_2}{P_2 n_1 T_1} = \frac{(1)(V_1)(1)(3T_1)}{(1)(1)(T_1)} \quad V_2 = 3V_1$$

c) As the number of molecules of gas increases at constant pressure and temperature ( $P$  and  $T$  are fixed), the force they exert on the container increases. This results in an increase in the volume of the container. Adding 3 moles of gas to 1 mole increases the number of moles by a factor of 4, thus the **volume increases by a factor of 4** (Avogadro's law).

$$V_2 = \frac{P_1 V_1 n_2 T_2}{P_2 n_1 T_1} = \frac{(1)(V_1)(4n_1)(1)}{(1)(n_1)(1)} \quad V_2 = 4V_1$$

5.15 Plan: Use the relationship  $\frac{P_1 V_1}{T_1} = \frac{P_2 V_2}{T_2}$  or  $V_2 = \frac{P_1 V_1 T_2}{P_2 T_1}$ .  $R$  and  $n$  are fixed.

Solution:

a) As the pressure on a fixed amount of gas ( $n$  is fixed) decreases at constant temperature ( $T$  is fixed), the molecules move farther together, increasing the volume. When the pressure is reduced by a factor of 4, the **volume increases by a factor of 4** at constant temperature (Boyle's law).

$$V_2 = \frac{P_1 V_1 T_2}{P_2 T_1} = \frac{(P_1)(V_1)(1)}{(1/4P_1)(1)} \quad V_2 = 4V_1$$

b) As the pressure on a fixed amount of gas ( $n$  is fixed) doubles from 101 kPa to 202 kPa at constant temperature, the volume decreases by a factor of  $1/2$ . As the temperature of a fixed amount of gas ( $n$  is fixed) decreases by a factor of  $1/2$  (from 310 K to 155 K) at constant pressure, the volume decreases by a factor of  $1/2$ . The changes in pressure and temperature combine to **decrease the volume by a factor of 4**.

$$P_1 = 760 \text{ torr} = 101 \text{ kPa} \quad T_1 = 37^\circ\text{C} + 273 = 310 \text{ K}$$

$$V_2 = \frac{P_1 V_1 T_2}{P_2 T_1} = \frac{(101 \text{ kPa})(V_1)(155 \text{ K})}{(202 \text{ kPa})(310 \text{ K})} \quad V_2 = \frac{1}{4} V_1$$

c) As the pressure on a fixed amount of gas ( $n$  is fixed) decreases at constant temperature ( $T$  is fixed), the molecules move farther together, increasing the volume. When the pressure is reduced by a factor of 2, the **volume increases by a factor of 2** at constant temperature (Boyle's law).

$$T_2 = 32^\circ\text{C} + 273 = 305 \text{ K} \quad P_2 = 101 \text{ kPa} = 1 \text{ atm}$$

$$V_2 = \frac{P_1 V_1 T_2}{P_2 T_1} = \frac{(2 \text{ atm})(V_1)(305 \text{ K})}{(1 \text{ atm})(305 \text{ K})} \quad V_2 = 2V_1$$

5.16 Plan: This is Charles's law: at constant pressure and with a fixed amount of gas, the volume of a gas is directly proportional to the absolute temperature of the gas. The temperature must be lowered to reduce the volume of a gas. Arrange the ideal gas law, solving for  $T_2$  at fixed  $n$  and  $P$ . Temperature must be converted to kelvin.

Solution:

$$V_1 = 9.10 \text{ L} \quad V_2 = 2.50 \text{ L}$$

$$T_1 = 198^\circ\text{C} \text{ (convert to K)} \quad T_2 = \text{unknown}$$

$n$  and  $P$  remain constant

$$\text{Converting } T \text{ from } ^\circ\text{C} \text{ to K: } T_1 = 198^\circ\text{C} + 273 = 471 \text{ K}$$

Arranging the ideal gas law and solving for  $T_2$ :

$$\frac{P_1 V_1}{n_1 T_1} = \frac{P_2 V_2}{n_2 T_2} \quad \text{or} \quad \frac{V_1}{T_1} = \frac{V_2}{T_2}$$

$$T_2 = T_1 \frac{V_2}{V_1} = 471 \text{ K} \left( \frac{2.50 \text{ L}}{9.10 \text{ L}} \right) = 129.396 \text{ K} - 273 = -143.604 = \mathbf{-144^\circ\text{C}}$$

5.17 Plan: This is Charles's law: at constant pressure and with a fixed amount of gas, the volume of a gas is directly proportional to the absolute temperature of the gas. If temperature is reduced, the volume of gas will also be reduced. Arrange the ideal gas law, solving for  $V_2$  at fixed  $n$  and  $P$ . Temperature must be converted to kelvins.

**Solution:**

$$V_1 = 93 \text{ L}$$

$$V_2 = \text{unknown}$$

$$T_1 = 145^\circ\text{C (convert to K)}$$

$$T_2 = -22^\circ\text{C}$$

$n$  and  $P$  remain constant

$$\text{Converting } T \text{ from } ^\circ\text{C to K: } T_1 = 145^\circ\text{C} + 273 = 418 \text{ K}$$

$$T_2 = -22^\circ\text{C} + 273 = 251 \text{ K}$$

Arranging the ideal gas law and solving for  $V_2$ :

$$\frac{P_1 V_1}{n_1 T_1} = \frac{P_2 V_2}{n_2 T_2} \quad \text{or} \quad \frac{V_1}{T_1} = \frac{V_2}{T_2}$$

$$V_2 = V_1 \frac{T_2}{T_1} = 93 \text{ L} \left( \frac{251 \text{ K}}{418 \text{ K}} \right) = 55.844 = \mathbf{56 \text{ L}}$$

- 5.18 **Plan:** Since the volume, temperature, and pressure of the gas are changing, use the combined gas law. Arrange the ideal gas law, solving for  $V_2$  at fixed  $n$ . STP is  $0^\circ\text{C}$  (273 K) and 1 atm (101.325 kPa)

**Solution:**

$$P_1 = 153.3 \text{ kPa}$$

$$P_2 = 101.325 \text{ kPa}$$

$$V_1 = 25.5 \text{ L}$$

$$V_2 = \text{unknown}$$

$$T_1 = 298 \text{ K}$$

$$T_2 = 273 \text{ K}$$

$n$  remains constant

Arranging the ideal gas law and solving for  $V_2$ :

$$\frac{P_1 V_1}{n_1 T_1} = \frac{P_2 V_2}{n_2 T_2} \quad \text{or} \quad \frac{P_1 V_1}{T_1} = \frac{P_2 V_2}{T_2}$$

$$V_2 = V_1 \left( \frac{T_2}{T_1} \right) \left( \frac{P_1}{P_2} \right) = (25.5 \text{ L}) \left( \frac{273 \text{ K}}{298 \text{ K}} \right) \left( \frac{153.3 \text{ kPa}}{101.325 \text{ kPa}} \right) = 35.3437 = \mathbf{35.3 \text{ L}}$$

- 5.19 **Plan:** Since the volume, temperature, and pressure of the gas are changing, use the combined gas law. Arrange the ideal gas law, solving for  $V_2$  at fixed  $n$ . Temperature must be converted to kelvins.

**Solution:**

$$P_1 = 745 \text{ torr}$$

$$P_2 = 367 \text{ torr}$$

$$V_1 = 3.65 \text{ L}$$

$$V_2 = \text{unknown}$$

$$T_1 = 298 \text{ K}$$

$$T_2 = -14^\circ\text{C} + 273 = 259 \text{ K}$$

$n$  remains constant

Arranging the ideal gas law and solving for  $V_2$ :

$$\frac{P_1 V_1}{n_1 T_1} = \frac{P_2 V_2}{n_2 T_2} \quad \text{or} \quad \frac{P_1 V_1}{T_1} = \frac{P_2 V_2}{T_2}$$

$$V_2 = V_1 \left( \frac{T_2}{T_1} \right) \left( \frac{P_1}{P_2} \right) = (3.65 \text{ L}) \left( \frac{259 \text{ K}}{298 \text{ K}} \right) \left( \frac{745 \text{ torr}}{367 \text{ torr}} \right) = 6.4397 = \mathbf{6.44 \text{ L}}$$

- 5.20 **Plan:** Given the volume, pressure, and temperature of a gas, the number of moles of the gas can be calculated using the ideal gas law, solving for  $n$ . The gas constant,  $R = 0.0821 \text{ L}\cdot\text{atm}/\text{mol}\cdot\text{K}$ , gives pressure in atmospheres and temperature in Kelvin. The given pressure in torr must be converted to atmospheres and the temperature converted to kelvins.

**Solution:**

$$P = 328 \text{ torr (convert to atm)}$$

$$V = 5.0 \text{ L}$$

$$T = 37^\circ\text{C}$$

$$n = \text{unknown}$$

$$\text{Converting } P \text{ from torr to atm: } P = (328 \text{ torr}) \left( \frac{1 \text{ atm}}{760 \text{ torr}} \right) = 0.43158 \text{ atm}$$

$$\text{Converting } T \text{ from } ^\circ\text{C to K:}$$

$$T = 37^\circ\text{C} + 273 = 310 \text{ K}$$

$$PV = nRT$$

Solving for  $n$ :

$$n = \frac{PV}{RT} = \frac{(0.43158 \text{ atm})(5.0 \text{ L})}{\left(0.0821 \frac{\text{L}\cdot\text{atm}}{\text{mol}\cdot\text{K}}\right)(310 \text{ K})} = 0.08479 = \mathbf{0.085 \text{ mol chlorine}}$$

- 5.21 Plan: Given the volume, moles, and temperature of a gas, the pressure of the gas can be calculated using the ideal gas law, solving for  $P$ . The gas constant,  $R = 0.0821 \text{ L}\cdot\text{atm}/\text{mol}\cdot\text{K}$ , gives volume in liters and temperature in Kelvin. The given volume in mL must be converted to L and the temperature converted to kelvins.

Solution:

$$V = 75.0 \text{ mL}$$

$$T = 26^\circ\text{C}$$

$$n = 1.47 \times 10^{-3} \text{ mol}$$

$$P = \text{unknown}$$

$$\text{Converting } V \text{ from mL to L: } V = (75.0 \text{ mL})\left(\frac{10^{-3} \text{ L}}{1 \text{ mL}}\right) = 0.0750 \text{ L}$$

$$\text{Converting } T \text{ from } ^\circ\text{C} \text{ to K: } T = 26^\circ\text{C} + 273 = 299 \text{ K}$$

$$PV = nRT$$

Solving for  $P$ :

$$P = \frac{nRT}{V} = \frac{(1.47 \times 10^{-3} \text{ mol})\left(0.0821 \frac{\text{L}\cdot\text{atm}}{\text{mol}\cdot\text{K}}\right)(299 \text{ K})}{0.0750 \text{ L}} = 0.48114 \text{ atm}$$

$$\text{Convert } P \text{ to units of torr: } (0.48114 \text{ atm})\left(\frac{760 \text{ torr}}{1 \text{ atm}}\right) = 365.6664 = \mathbf{366 \text{ torr}}$$

- 5.22 Plan: Solve the ideal gas law for moles and convert to mass using the molar mass of  $\text{ClF}_3$ . The gas constant,  $R = 0.0821 \text{ L}\cdot\text{atm}/\text{mol}\cdot\text{K}$ , gives volume in liters, pressure in atmospheres, and temperature in Kelvin so volume must be converted to L, pressure to atm, and temperature to K.

Solution:

$$V = 357 \text{ mL}$$

$$T = 45^\circ\text{C}$$

$$P = 699 \text{ mmHg}$$

$$n = \text{unknown}$$

$$\text{Converting } V \text{ from mL to L: } V = (357 \text{ mL})\left(\frac{10^{-3} \text{ L}}{1 \text{ mL}}\right) = 0.357 \text{ L}$$

$$\text{Converting } T \text{ from } ^\circ\text{C} \text{ to K: } T = 45^\circ\text{C} + 273 = 318 \text{ K}$$

$$\text{Converting } P \text{ from mmHg to atm: } P = (699 \text{ mmHg})\left(\frac{1 \text{ atm}}{760 \text{ mmHg}}\right) = 0.91974 \text{ atm}$$

$$PV = nRT$$

Solving for  $n$ :

$$n = \frac{PV}{RT} = \frac{(0.91974 \text{ atm})(0.357 \text{ L})}{\left(0.0821 \frac{\text{L}\cdot\text{atm}}{\text{mol}\cdot\text{K}}\right)(318 \text{ K})} = 0.01258 \text{ mol ClF}_3$$

$$\text{Mass ClF}_3 = (0.01258 \text{ mol ClF}_3) \left(\frac{92.45 \text{ g ClF}_3}{1 \text{ mol ClF}_3}\right) = 1.163021 = \mathbf{1.16 \text{ g ClF}_3}$$

- 5.23 Plan: Solve the ideal gas law for pressure; convert mass to moles using the molar mass of  $\text{N}_2\text{O}$ . The gas constant,  $R = 0.0821 \text{ L}\cdot\text{atm}/\text{mol}\cdot\text{K}$ , gives temperature in Kelvin so the temperature must be converted to units of kelvins.

Solution:

$$V = 3.1 \text{ L}$$

$$T = 115^\circ\text{C}$$

$$n = 75.0 \text{ g (convert to moles)}$$

$$P = \text{unknown}$$

$$\text{Converting } T \text{ from } ^\circ\text{C} \text{ to K:}$$

$$T = 115^\circ\text{C} + 273 = 388 \text{ K}$$

Converting from mass of  $\text{N}_2\text{O}$  to moles:  $n = (75.0 \text{ g N}_2\text{O}) \left( \frac{1 \text{ mol N}_2\text{O}}{44.02 \text{ g N}_2\text{O}} \right) = 1.70377 \text{ mol N}_2\text{O}$

$$PV = nRT$$

Solving for  $P$ :

$$P = \frac{nRT}{V} = \frac{(1.70377 \text{ mol}) \left( 0.0821 \frac{\text{L}\cdot\text{atm}}{\text{mol}\cdot\text{K}} \right) (388 \text{ K})}{(3.1 \text{ L})} = 17.5075 = \mathbf{18 \text{ atm N}_2\text{O}}$$

- 5.24 Plan: Solve the ideal gas law for moles. The gas constant,  $R = 0.0821 \text{ L}\cdot\text{atm}/\text{mol}\cdot\text{K}$ , gives pressure in atmospheres, and temperature in Kelvin so pressure must be converted to atm and temperature to K.

Solution:

$$V = 1.5 \text{ L}$$

$$T = 23^\circ\text{C}$$

$$P = 85 + 14.7 = 99.7 \text{ psi}$$

$$n = \text{unknown}$$

Converting  $T$  from  $^\circ\text{C}$  to K:

$$T = 23^\circ\text{C} + 273 = 296 \text{ K}$$

Converting  $P$  from psi to atm:

$$P = (99.7 \text{ psi}) \left( \frac{1 \text{ atm}}{14.7 \text{ psi}} \right) = 6.7823 \text{ atm}$$

$$PV = nRT$$

Solving for  $n$ :

$$n = \frac{PV}{RT} = \frac{(6.7823 \text{ atm})(1.5 \text{ L})}{\left( 0.0821 \frac{\text{L}\cdot\text{atm}}{\text{mol}\cdot\text{K}} \right) (296 \text{ K})} = 0.41863 = \mathbf{0.42 \text{ mol SO}_2}$$

- 5.25 Air is mostly  $\text{N}_2$  (28.02 g/mol),  $\text{O}_2$  (32.00 g/mol), and argon (39.95 g/mol). These “heavy” gases dominate the density of dry air. Moist air contains  $\text{H}_2\text{O}$  (18.02 g/mol). The relatively light water molecules lower the density of the moist air.

- 5.26 The molar mass of  $\text{H}_2$  is less than the average molar mass of air (mostly  $\text{N}_2$ ,  $\text{O}_2$ , and Ar), so air is denser. To collect a beaker of  $\text{H}_2(\text{g})$ , **invert** the beaker so that the air will be replaced by the lighter  $\text{H}_2$ . The molar mass of  $\text{CO}_2$  is greater than the average molar mass of air, so  $\text{CO}_2(\text{g})$  is more dense. Collect the  $\text{CO}_2$  holding the beaker **upright**, so the lighter air will be displaced out the top of the beaker.

- 5.27 Gases mix to form a solution and each gas in the solution behaves as if it were the only gas present.

- 5.28  $P_A = X_A P_T$  The partial pressure of a gas ( $P_A$ ) in a mixture is directly proportional to its mole fraction ( $X_A$ ).

- 5.29 Plan: Calculate the mole fraction of each gas; the partial pressure of each gas is directly proportional to its mole fraction so the gas with the highest mole fraction has the highest partial pressure. Use the relationship between partial pressure and mole fraction to calculate the partial pressure of gas  $\text{D}_2$ .

Solution:

$$\text{a) } X_A = \frac{n_A}{n_{\text{total}}} = \frac{4 \text{ A particles}}{16 \text{ total particles}} = 0.25$$

$$X_B = \frac{n_B}{n_{\text{total}}} = \frac{3 \text{ B particles}}{16 \text{ total particles}} = 0.1875$$

$$X_C = \frac{n_C}{n_{\text{total}}} = \frac{5 \text{ C particles}}{16 \text{ total particles}} = 0.3125$$

$$X_{\text{D}_2} = \frac{n_{\text{D}_2}}{n_{\text{total}}} = \frac{4 \text{ D}_2 \text{ particles}}{16 \text{ total particles}} = 0.25$$

**Gas C** has the highest mole fraction and thus the highest partial pressure.

b) **Gas B** has the lowest mole fraction and thus the lowest partial pressure.

$$\text{c) } P_{\text{D}_2} = X_{\text{D}_2} \times P_{\text{total}} \quad P_{\text{D}_2} = 0.25 \times 0.75 \text{ atm} = 0.1875 = \mathbf{0.19 \text{ atm}}$$

- 5.30 Plan: Rearrange the ideal gas law to calculate the density of xenon from its molar mass at STP. Standard temperature is  $0^\circ\text{C}$  (273 K) and standard pressure is 1 atm. Do not forget that the pressure at STP is exact and will not affect the significant figures.

Solution:

$$P = 1 \text{ atm}$$

$$T = 273 \text{ K}$$

$$\mathcal{M} \text{ of Xe} = 131.3 \text{ g/mol}$$

$$d = \text{unknown}$$

$$PV = nRT$$

$$\text{Rearranging to solve for density: } d = \frac{P\mathcal{M}}{RT} = \frac{(1 \text{ atm})(131.3 \text{ g/mol})}{\left(0.0821 \frac{\text{L}\cdot\text{atm}}{\text{mol}\cdot\text{K}}\right)(273 \text{ K})} = 5.8581 = \mathbf{5.86 \text{ g/L}}$$

- 5.31 Plan: Rearrange the ideal gas law to calculate the density of  $\text{CFCl}_3$  from its molar mass. Temperature must be converted to kelvins.

Solution:

$$P = 1.5 \text{ atm}$$

$$T = 120^\circ\text{C} + 273 = 393 \text{ K}$$

$$\mathcal{M} \text{ of CFCl}_3 = 137.4 \text{ g/mol}$$

$$d = \text{unknown}$$

$$PV = nRT$$

Rearranging to solve for density:

$$d = \frac{P\mathcal{M}}{RT} = \frac{(1.5 \text{ atm})(137.4 \text{ g/mol})}{\left(0.0821 \frac{\text{L}\cdot\text{atm}}{\text{mol}\cdot\text{K}}\right)(393 \text{ K})} = 6.385807663 = \mathbf{6.4 \text{ g/L}}$$

- 5.32 Plan: Solve the ideal gas law for moles. Convert moles to mass using the molar mass of  $\text{AsH}_3$  and divide this mass by the volume to obtain density in  $\text{g/L}$ . Standard temperature is  $0^\circ\text{C}$  (273 K) and standard pressure is 1 atm. Do not forget that the pressure at STP is exact and will not affect the significant figures.

Solution:

$$V = 0.0400 \text{ L}$$

$$T = 0^\circ\text{C} + 273 = 273 \text{ K}$$

$$P = 1 \text{ atm}$$

$$n = \text{unknown}$$

$$\mathcal{M} \text{ of AsH}_3 = 77.94 \text{ g/mol}$$

$$PV = nRT$$

Solving for  $n$ :

$$n = \frac{PV}{RT} = \frac{(1 \text{ atm})(0.0400 \text{ L})}{\left(0.0821 \frac{\text{L}\cdot\text{atm}}{\text{mol}\cdot\text{K}}\right)(273 \text{ K})} = 1.78465 \times 10^{-3} = \mathbf{1.78 \times 10^{-3} \text{ mol AsH}_3}$$

Converting moles of  $\text{AsH}_3$  to mass of  $\text{AsH}_3$ :

$$\text{Mass (g) of AsH}_3 = \left(1.78465 \times 10^{-3} \text{ mol AsH}_3\right) \left(\frac{77.94 \text{ g AsH}_3}{1 \text{ mol AsH}_3}\right) = 0.1391 \text{ g AsH}_3$$

$$d = \frac{\text{mass}}{\text{volume}} = \frac{(0.1391 \text{ g})}{(0.0400 \text{ L})} = 3.4775 = \mathbf{3.48 \text{ g/L}}$$

- 5.33 Plan: Solve the density form of the ideal gas law for molar mass. Temperature must be converted to kelvins. Compare the calculated molar mass to the molar mass values of the noble gases to determine the identity of the gas.

Solution:

$$P = 3.00 \text{ atm}$$

$$T = 0^\circ\text{C} + 273 = 273 \text{ K}$$

$$d = 2.71 \text{ g/L}$$

$$\mathcal{M} = \text{unknown}$$

$$d = \frac{P\mathcal{M}}{RT}$$

Rearranging to solve for molar mass:

$$\mathcal{M} = \frac{dRT}{P} = \frac{(2.71 \text{ g/L}) \left(0.0821 \frac{\text{L}\cdot\text{atm}}{\text{mol}\cdot\text{K}}\right) (273 \text{ K})}{(3.00 \text{ atm})} = 20.24668 = 20.2 \text{ g/mol}$$

Therefore, the gas is **Ne**.

- 5.34 Plan: Rearrange the formula  $PV = (m/M)RT$  to solve for molar mass. Convert the mass in ng to g and volume in  $\mu\text{L}$  to L. Temperature must be in Kelvin and pressure in atm.

Solution:

$$V = 0.206 \mu\text{L}$$

$$T = 45^\circ\text{C} + 273 = 318 \text{ K}$$

$$P = 380 \text{ torr}$$

$$m = 206 \text{ ng}$$

$M$  = unknown

$$\text{Converting } P \text{ from torr to atm: } P = (380 \text{ torr}) \left( \frac{1 \text{ atm}}{760 \text{ torr}} \right) = 0.510526 \text{ atm}$$

$$\text{Converting } V \text{ from } \mu\text{L} \text{ to L: } V = (0.206 \mu\text{L}) \left( \frac{10^{-6} \text{ L}}{1 \mu\text{L}} \right) = 2.06 \times 10^{-7} \text{ L}$$

$$\text{Converting } m \text{ from ng to g: } m = (206 \text{ ng}) \left( \frac{10^{-9} \text{ g}}{1 \text{ ng}} \right) = 2.06 \times 10^{-7} \text{ g}$$

$$PV = \left( \frac{m}{M} \right) RT$$

Solving for molar mass,  $M$ :

$$M = \frac{mRT}{PV} = \frac{(2.06 \times 10^{-7} \text{ g}) \left( 0.0821 \frac{\text{L} \cdot \text{atm}}{\text{mol} \cdot \text{K}} \right) (318 \text{ K})}{(0.510526 \text{ atm}) (2.06 \times 10^{-7} \text{ L})} = 51.1390 = \mathbf{51.1 \text{ g/mol}}$$

- 5.35 Plan: Rearrange the formula  $PV = (m/M)RT$  to solve for molar mass. Compare the calculated molar mass to that of  $\text{N}_2$ , Ne, and Ar to determine the identity of the gas. Convert volume to liters, pressure to atm, and temperature to Kelvin.

Solution:

$$V = 63.8 \text{ mL}$$

$$T = 22^\circ\text{C} + 273 = 295 \text{ K}$$

$$P = 747 \text{ mm Hg}$$

$$m = 0.103 \text{ g}$$

$M$  = unknown

$$\text{Converting } P \text{ from mmHg to atm: } P = (747 \text{ mmHg}) \left( \frac{1 \text{ atm}}{760 \text{ mmHg}} \right) = 0.982895 \text{ atm}$$

$$\text{Converting } V \text{ from mL to L: } V = (63.8 \text{ mL}) \left( \frac{10^{-3} \text{ L}}{1 \text{ mL}} \right) = 0.0638 \text{ L}$$

$$PV = \left( \frac{m}{M} \right) RT$$

Solving for molar mass,  $M$ :

$$M = \frac{mRT}{PV} = \frac{(0.103 \text{ g}) \left( 0.0821 \frac{\text{L} \cdot \text{atm}}{\text{mol} \cdot \text{K}} \right) (295 \text{ K})}{(0.982895 \text{ atm}) (0.0638 \text{ L})} = 39.7809 = 39.8 \text{ g/mol}$$

The molar masses are  $\text{N}_2 = 28 \text{ g/mol}$ , Ne = 20 g/mol, and Ar = 40 g/mol. Therefore, the gas is **Ar**.

- 5.36 Plan: Use the ideal gas law to determine the number of moles of Ar and of  $\text{O}_2$ . The gases are combined ( $n_{\text{total}} = n_{\text{Ar}} + n_{\text{O}_2}$ ) into a 400 mL flask ( $V$ ) at  $27^\circ\text{C}$  ( $T$ ). Use the ideal gas law again to determine the total pressure from  $n_{\text{total}}$ ,  $V$ , and  $T$ . Pressure must be in units of atm, volume in units of L and temperature in K.

Solution:

For Ar:

$$V = 0.600 \text{ L}$$

$$T = 227^\circ\text{C} + 273 = 500. \text{ K}$$

$$P = 1.20 \text{ atm}$$

$$n = \text{unknown}$$

$$PV = nRT$$

Solving for  $n$ :

$$n = \frac{PV}{RT} = \frac{(1.20 \text{ atm})(0.600 \text{ L})}{\left(0.0821 \frac{\text{L}\cdot\text{atm}}{\text{mol}\cdot\text{K}}\right)(500. \text{ K})} = 0.017539586 \text{ mol Ar}$$

For  $\text{O}_2$ :

$$V = 0.200 \text{ L} \quad T = 127^\circ\text{C} + 273 = 400. \text{ K}$$

$$P = 501 \text{ torr} \quad n = \text{unknown}$$

Converting  $P$  from torr to atm:  $P = (501 \text{ torr})\left(\frac{1 \text{ atm}}{760 \text{ torr}}\right) = 0.6592105 \text{ atm}$

$$PV = nRT$$

Solving for  $n$ :

$$n = \frac{PV}{RT} = \frac{(0.6592105 \text{ atm})(0.200 \text{ L})}{\left(0.0821 \frac{\text{L}\cdot\text{atm}}{\text{mol}\cdot\text{K}}\right)(400. \text{ K})} = 0.004014680 \text{ mol O}_2$$

$$n_{\text{total}} = n_{\text{Ar}} + n_{\text{O}_2} = 0.017539586 \text{ mol} + 0.004014680 \text{ mol} = 0.021554266 \text{ mol}$$

For the mixture of Ar and  $\text{O}_2$ :

$$V = 400 \text{ mL} \quad T = 27^\circ\text{C} + 273 = 300. \text{ K}$$

$$P = \text{unknown} \quad n = 0.021554265 \text{ mol}$$

Converting  $V$  from mL to L:  $V = (400 \text{ mL})\left(\frac{10^{-3} \text{ L}}{1 \text{ mL}}\right) = 0.400 \text{ L}$

$$PV = nRT$$

Solving for  $P$ :

$$P_{\text{mixture}} = \frac{nRT}{V} = \frac{(0.021554266 \text{ mol})\left(0.0821 \frac{\text{L}\cdot\text{atm}}{\text{mol}\cdot\text{K}}\right)(300 \text{ K})}{(0.400 \text{ L})} = 1.32720 = \mathbf{1.33 \text{ atm}}$$

- 5.37 Plan: Use the ideal gas law, solving for  $n$  to find the total moles of gas. Convert the mass of Ne to moles and subtract moles of Ne from the total number of moles to find moles of Ar. Volume must be in units of liters, pressure in units of atm, and temperature in kelvins.

Solution:

$$V = 355 \text{ mL} \quad T = 35^\circ\text{C} + 273 = 308 \text{ K}$$

$$P = 626 \text{ mmHg} \quad n_{\text{total}} = \text{unknown}$$

Converting  $P$  from mmHg to atm:  $P = (626 \text{ mmHg})\left(\frac{1 \text{ atm}}{760 \text{ mmHg}}\right) = 0.823684 \text{ atm}$

Converting  $V$  from mL to L:  $V = (355 \text{ mL})\left(\frac{10^{-3} \text{ L}}{1 \text{ mL}}\right) = 0.355 \text{ L}$

$$PV = nRT$$

Solving for  $n_{\text{total}}$ :

$$n_{\text{total}} = \frac{PV}{RT} = \frac{(0.823684 \text{ atm})(0.355 \text{ L})}{\left(0.0821 \frac{\text{L}\cdot\text{atm}}{\text{mol}\cdot\text{K}}\right)(308 \text{ K})} = 0.011563655 \text{ mol Ne} + \text{mol Ar}$$

$$\text{Moles Ne} = (0.146 \text{ g Ne})\left(\frac{1 \text{ mol Ne}}{20.18 \text{ g Ne}}\right) = 0.007234886 \text{ mol Ne}$$

$$\text{Moles Ar} = n_{\text{total}} - n_{\text{Ne}} = (0.011563655 - 0.007234886) \text{ mol} = 0.004328769 = \mathbf{0.0043 \text{ mol Ar}}$$



- 5.38 **Plan:** Use the ideal gas law, solving for  $n$  to find the moles of  $O_2$ . Use the molar ratio from the balanced equation to determine the moles (and then mass) of phosphorus that will react with the oxygen. Standard temperature is  $0^\circ\text{C}$  (273 K) and standard pressure is 1 atm.

**Solution:**

$$V = 35.5 \text{ L} \qquad T = 0^\circ\text{C} + 273 = 273 \text{ K}$$

$$P = 1 \text{ atm} \qquad n = \text{unknown}$$

$$PV = nRT$$

Solving for  $n$ :

$$n = \frac{PV}{RT} = \frac{(1 \text{ atm})(35.5 \text{ L})}{\left(0.0821 \frac{\text{L}\cdot\text{atm}}{\text{mol}\cdot\text{K}}\right)(273 \text{ K})} = 1.583881 \text{ mol } O_2$$

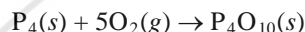

$$\text{Mass } P_4 = (1.583881 \text{ mol } O_2) \left( \frac{1 \text{ mol } P_4}{5 \text{ mol } O_2} \right) \left( \frac{123.88 \text{ g } P_4}{1 \text{ mol } P_4} \right) = 39.24224 = \mathbf{39.2 \text{ g } P_4}$$

- 5.39 **Plan:** Use the ideal gas law, solving for  $n$  to find the moles of  $O_2$  produced. Volume must be in units of liters, pressure in atm, and temperature in kelvins. Use the molar ratio from the balanced equation to determine the moles (and then mass) of potassium chlorate that reacts.

**Solution:**

$$V = 638 \text{ mL} \qquad T = 128^\circ\text{C} + 273 = 401 \text{ K}$$

$$P = 752 \text{ torr} \qquad n = \text{unknown}$$

$$\text{Converting } P \text{ from torr to atm: } P = (752 \text{ torr}) \left( \frac{1 \text{ atm}}{760 \text{ torr}} \right) = 0.9894737 \text{ atm}$$

$$\text{Converting } V \text{ from mL to L: } V = (638 \text{ mL}) \left( \frac{10^{-3} \text{ L}}{1 \text{ mL}} \right) = 0.638 \text{ L}$$

$$PV = nRT$$

Solving for  $n$ :

$$n = \frac{PV}{RT} = \frac{(0.9894737 \text{ atm})(0.638 \text{ L})}{\left(0.0821 \frac{\text{L}\cdot\text{atm}}{\text{mol}\cdot\text{K}}\right)(401 \text{ K})} = 0.0191751 \text{ mol } O_2$$



$$\text{Mass (g) of } KClO_3 = (0.0191751 \text{ mol } O_2) \left( \frac{2 \text{ mol } KClO_3}{3 \text{ mol } O_2} \right) \left( \frac{122.55 \text{ g } KClO_3}{1 \text{ mol } KClO_3} \right) = 1.5666 = \mathbf{1.57 \text{ g } KClO_3}$$

- 5.40 **Plan:** Since the amounts of two reactants are given, this is a limiting reactant problem. To find the mass of  $PH_3$ , write the balanced equation and use molar ratios to find the number of moles of  $PH_3$  produced by each reactant. The smaller number of moles of product indicates the limiting reagent. Solve for moles of  $H_2$  using the ideal gas law.

**Solution:**

Moles of hydrogen:

$$V = 83.0 \text{ L} \qquad T = 0^\circ\text{C} + 273 = 273 \text{ K}$$

$$P = 1 \text{ atm} \qquad n = \text{unknown}$$

$$PV = nRT$$

Solving for  $n$ :

$$n = \frac{PV}{RT} = \frac{(1 \text{ atm})(83.0 \text{ L})}{\left(0.0821 \frac{\text{L}\cdot\text{atm}}{\text{mol}\cdot\text{K}}\right)(273 \text{ K})} = 3.7031584 \text{ mol } H_2$$

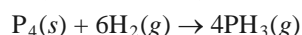

$$\text{PH}_3 \text{ from P}_4 = (37.5 \text{ g P}_4) \left( \frac{1 \text{ mol P}_4}{123.88 \text{ g P}_4} \right) \left( \frac{4 \text{ mol PH}_3}{1 \text{ mol P}_4} \right) = 1.21085 \text{ mol PH}_3$$

$$\text{PH}_3 \text{ from H}_2 = (3.7031584 \text{ mol H}_2) \left( \frac{4 \text{ mol PH}_3}{6 \text{ mol H}_2} \right) = 2.4687723 \text{ mol PH}_3$$

P<sub>4</sub> is the limiting reactant because it forms less PH<sub>3</sub>.

$$\text{Mass PH}_3 = (37.5 \text{ g P}_4) \left( \frac{1 \text{ mol P}_4}{123.88 \text{ g P}_4} \right) \left( \frac{4 \text{ mol PH}_3}{1 \text{ mol P}_4} \right) \left( \frac{33.99 \text{ g PH}_3}{1 \text{ mol PH}_3} \right) = 41.15676 = \mathbf{41.2 \text{ g PH}_3}$$

- 5.41 Plan: Since the amounts of two reactants are given, this is a limiting reactant problem. To find the mass of NO, write the balanced equation and use molar ratios to find the number of moles of NO produced by each reactant. Since the moles of gas are directly proportional to the volumes of the gases at the same temperature and pressure, the limiting reactant may be found by comparing the volumes of the gases. The smaller volume of product indicates the limiting reagent. Then use the ideal gas law to convert the volume of NO produced to moles and then to mass.

Solution:

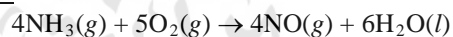

$$\text{Mol NO from NH}_3 = (35.6 \text{ L NH}_3) \left( \frac{4 \text{ L NO}}{4 \text{ L NH}_3} \right) = 35.6 \text{ L NO}$$

$$\text{Mol NO from O}_2 = (40.5 \text{ L O}_2) \left( \frac{4 \text{ L NO}}{5 \text{ L O}_2} \right) = 32.4 \text{ L NO}$$

O<sub>2</sub> is the limiting reactant since it forms less NO.

Converting volume of NO to moles and then mass:

$$V = 32.4 \text{ L}$$

$$T = 0^\circ\text{C} + 273 = 273 \text{ K}$$

$$P = 1 \text{ atm}$$

$$n = \text{unknown}$$

$$PV = nRT$$

Solving for  $n$ :

$$n = \frac{PV}{RT} = \frac{(1 \text{ atm})(32.4 \text{ L})}{\left(0.0821 \frac{\text{L}\cdot\text{atm}}{\text{mol}\cdot\text{K}}\right)(273 \text{ K})} = 1.44557 \text{ mol NO}$$

$$\text{Mass (g) of NO} = (1.44557 \text{ mol NO}) \left( \frac{30.01 \text{ g NO}}{1 \text{ mol NO}} \right) = 43.38156 = \mathbf{43.4 \text{ g NO}}$$

- 5.42 Plan: First, write the balanced equation. The moles of hydrogen produced can be calculated from the ideal gas law. The problem specifies that the hydrogen gas is collected over water, so the partial pressure of water vapor must be subtracted from the overall pressure given. Table 5.2 reports pressure at 26°C (25.2 torr) and 28°C (28.3 torr), so take the average of the two values to obtain the partial pressure of water at 27°C. Volume must be in units of liters, pressure in atm, and temperature in kelvins. Once the moles of hydrogen produced are known, the molar ratio from the balanced equation is used to determine the moles of aluminum that reacted.

Solution:

$$V = 35.8 \text{ mL}$$

$$T = 27^\circ\text{C} + 273 = 300 \text{ K}$$

$$P_{\text{total}} = 751 \text{ mmHg}$$

$$n = \text{unknown}$$

$$P_{\text{water vapor}} = (28.3 + 25.2) \text{ torr}/2 = 26.75 \text{ torr} = 26.75 \text{ mmHg}$$

$$P_{\text{hydrogen}} = P_{\text{total}} - P_{\text{water vapor}} = 751 \text{ mmHg} - 26.75 \text{ mmHg} = 724.25 \text{ mmHg}$$

$$\text{Converting } P \text{ from mmHg to atm: } P = (724.25 \text{ mmHg}) \left( \frac{1 \text{ atm}}{760 \text{ mmHg}} \right) = 0.952960526 \text{ atm}$$

$$\text{Converting } V \text{ from mL to L: } V = (35.8 \text{ mL}) \left( \frac{10^{-3} \text{ L}}{1 \text{ mL}} \right) = 0.0358 \text{ L}$$

$$PV = nRT$$

Solving for  $n$ :

$$n = \frac{PV}{RT} = \frac{(0.952960526 \text{ atm})(0.0358 \text{ L})}{\left(0.0821 \frac{\text{L}\cdot\text{atm}}{\text{mol}\cdot\text{K}}\right)(300. \text{ K})} = 0.0013851395 \text{ mol H}_2$$

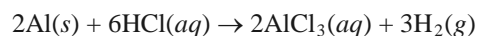

$$\text{Mass (g) of Al} = (0.0013851395 \text{ mol H}_2) \left( \frac{2 \text{ mol Al}}{3 \text{ mol H}_2} \right) \left( \frac{26.98 \text{ g Al}}{1 \text{ mol Al}} \right) = 0.024914 = \mathbf{0.0249 \text{ g Al}}$$

- 5.43 Plan: First, write the balanced equation. Convert mass of lithium to moles and use the molar ratio from the balanced equation to find the moles of hydrogen gas produced. Use the ideal gas law to find the volume of that amount of hydrogen. The problem specifies that the hydrogen gas is collected over water, so the partial pressure of water vapor must be subtracted from the overall pressure given. Table 5.2 reports the vapor pressure of water at 18°C (15.5 torr). Pressure must be in units of atm and temperature in kelvins.

Solution:

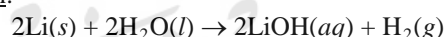

$$\text{Moles H}_2 = (0.84 \text{ g Li}) \left( \frac{1 \text{ mol Li}}{6.941 \text{ g Li}} \right) \left( \frac{1 \text{ mol H}_2}{2 \text{ mol Li}} \right) = 0.0605100 \text{ mol H}_2$$

Finding the volume of H<sub>2</sub>:

$V$  = unknown

$$T = 18^\circ\text{C} + 273 = 291 \text{ K}$$

$P_{\text{total}} = 725 \text{ mmHg}$

$$n = 0.0605100 \text{ mol}$$

$P_{\text{water vapor}} = 15.5 \text{ torr} = 15.5 \text{ mmHg}$

$$P_{\text{hydrogen}} = P_{\text{total}} - P_{\text{water vapor}} = 725 \text{ mmHg} - 15.5 \text{ mmHg} = 709.5 \text{ mmHg}$$

$$\text{Converting } P \text{ from mmHg to atm: } P = (709.5 \text{ mmHg}) \left( \frac{1 \text{ atm}}{760 \text{ mmHg}} \right) = 0.933552631 \text{ atm}$$

$$PV = nRT$$

Solving for  $V$ :

$$V = \frac{nRT}{P} = \frac{(0.0605100 \text{ mol}) \left( 0.0821 \frac{\text{L}\cdot\text{atm}}{\text{mol}\cdot\text{K}} \right) (291 \text{ K})}{(0.933552631 \text{ atm})} = 1.5485 = \mathbf{1.5 \text{ L H}_2}$$

- 5.44 Plan: Rearrange the ideal gas law to calculate the density of the air from its molar mass. Temperature must be converted to kelvins and pressure to atmospheres.

Solution:

$P = 744 \text{ torr}$

$$T = 17^\circ\text{C} + 273 = 290 \text{ K}$$

or

$$T = 60^\circ\text{C} + 273 = 333 \text{ K}$$

$\mathcal{M}$  of air = 28.8 g/mol

$d$  = unknown

$$\text{Converting } P \text{ from torr to atm: } P = (744 \text{ torr}) \left( \frac{1 \text{ atm}}{760 \text{ torr}} \right) = 0.978947368 \text{ atm}$$

$$PV = nRT$$

Rearranging to solve for density:

At 17°C

$$d = \frac{P\mathcal{M}}{RT} = \frac{(0.978947368 \text{ atm})(28.8 \text{ g/mol})}{\left(0.0821 \frac{\text{L}\cdot\text{atm}}{\text{mol}\cdot\text{K}}\right)(290 \text{ K})} = 1.18416 = \mathbf{1.18 \text{ g/L}}$$

At 60.0°C

$$d = \frac{P\mathcal{M}}{RT} = \frac{(0.978947368 \text{ atm})(28.8 \text{ g/mol})}{\left(0.0821 \frac{\text{L}\cdot\text{atm}}{\text{mol}\cdot\text{K}}\right)(333 \text{ K})} = 1.03125 = \mathbf{1.03 \text{ g/L}}$$

- 5.45 Plan: The problem gives the mass, volume, temperature, and pressure of a gas; rearrange the formula  $PV = (m/\mathcal{M})RT$  to solve for the molar mass of the gas. Temperature must be in Kelvin and pressure in atm. The problem also states that the gas is a hydrocarbon, which by, definition, contains only carbon and hydrogen atoms. We are also told that each molecule of the gas contains five carbon atoms so we can use this information and the calculated molar mass to find out how many hydrogen atoms are present and the formula of the compound.

Solution:

$$V = 0.204 \text{ L}$$

$$T = 101^\circ\text{C} + 273 = 374 \text{ K}$$

$$P = 767 \text{ torr}$$

$$m = 0.482 \text{ g}$$

$\mathcal{M}$  = unknown

Converting  $P$  from torr to atm: 
$$P = (767 \text{ torr})\left(\frac{1 \text{ atm}}{760 \text{ torr}}\right) = 1.009210526 \text{ atm}$$

$$PV = \left(\frac{m}{\mathcal{M}}\right)RT$$

Solving for molar mass,  $\mathcal{M}$ :

$$\mathcal{M} = \frac{mRT}{PV} = \frac{(0.482 \text{ g})\left(0.0821 \frac{\text{L}\cdot\text{atm}}{\text{mol}\cdot\text{K}}\right)(374 \text{ K})}{(1.009210526 \text{ atm})(0.204 \text{ L})} = 71.8869 \text{ g/mol}$$

The mass of the five carbon atoms accounts for  $[5(12 \text{ g/mol})] = 60 \text{ g/mol}$ ; thus, the hydrogen atoms must make up the difference  $(72 - 60) = 12 \text{ g/mol}$ . A value of  $12 \text{ g/mol}$  corresponds to  $12 \text{ H}$  atoms. (Since fractional atoms are not possible, rounding is acceptable.) Therefore, the molecular formula is  $\text{C}_5\text{H}_{12}$ .

- 5.46 Plan: Solve the ideal gas law for moles of air. Temperature must be in units of kelvins. Use Avogadro's number to convert moles of air to molecules of air. The percent composition can be used to find the number of molecules (or atoms) of each gas in that total number of molecules.

Solution:

$$V = 1.00 \text{ L}$$

$$T = 25^\circ\text{C} + 273 = 298 \text{ K}$$

$$P = 1.00 \text{ atm}$$

$n$  = unknown

$$PV = nRT$$

Solving for  $n$ :

$$\text{Moles of air} = n = \frac{PV}{RT} = \frac{(1.00 \text{ atm})(1.00 \text{ L})}{\left(0.0821 \frac{\text{L}\cdot\text{atm}}{\text{mol}\cdot\text{K}}\right)(298 \text{ K})} = 0.040873382 \text{ mol}$$

Converting moles of air to molecules of air:

$$\text{Molecules of air} = (0.040873382 \text{ mol})\left(\frac{6.022 \times 10^{23} \text{ molecules}}{1 \text{ mol}}\right) = 2.461395 \times 10^{22} \text{ molecules}$$

$$\begin{aligned} \text{Molecules of N}_2 &= (2.461395 \times 10^{22} \text{ air molecules})\left(\frac{78.08\% \text{ N}_2 \text{ molecules}}{100\% \text{ air}}\right) \\ &= 1.921857 \times 10^{22} = \mathbf{1.92 \times 10^{22} \text{ molecules N}_2} \end{aligned}$$

$$\begin{aligned} \text{Molecules of O}_2 &= (2.461395 \times 10^{22} \text{ air molecules})\left(\frac{20.94\% \text{ O}_2 \text{ molecules}}{100\% \text{ air}}\right) \\ &= 5.154161 \times 10^{21} = \mathbf{5.15 \times 10^{21} \text{ molecules O}_2} \end{aligned}$$

$$\begin{aligned} \text{Molecules of CO}_2 &= (2.461395 \times 10^{22} \text{ air molecules})\left(\frac{0.05\% \text{ CO}_2 \text{ molecules}}{100\% \text{ air}}\right) \\ &= 1.2306975 \times 10^{19} = \mathbf{1 \times 10^{19} \text{ molecules CO}_2} \end{aligned}$$

$$\begin{aligned} \text{Molecules of Ar} &= (2.461395 \times 10^{22} \text{ air molecules})\left(\frac{0.93\% \text{ Ar molecules}}{100\% \text{ air}}\right) \\ &= 2.289097 \times 10^{20} = \mathbf{2.3 \times 10^{20} \text{ molecules Ar}} \end{aligned}$$

- 5.47 Plan: Since you have the pressure, volume, and temperature, use the ideal gas law to solve for  $n$ , the total moles of gas. Pressure must be in units of atmospheres and temperature in units of kelvins. The partial pressure of  $\text{SO}_2$  can be found by multiplying the total pressure by the volume fraction of  $\text{SO}_2$ .

Solution:

$$\begin{array}{ll} \text{a) } V = 21 \text{ L} & T = 45^\circ\text{C} + 273 = 318 \text{ K} \\ P = 850 \text{ torr} & n = \text{unknown} \end{array}$$

Converting  $P$  from torr to atm:  $P = (850 \text{ torr})\left(\frac{1 \text{ atm}}{760 \text{ torr}}\right) = 1.118421053 \text{ atm}$

$$PV = nRT$$

$$\text{Moles of gas} = n = \frac{PV}{RT} = \frac{(1.118421053 \text{ atm})(21 \text{ L})}{\left(0.0821 \frac{\text{L}\cdot\text{atm}}{\text{mol}\cdot\text{K}}\right)(318 \text{ K})} = 0.89961 = \mathbf{0.90 \text{ mol gas}}$$

- b) The equation  $P_{\text{SO}_2} = X_{\text{SO}_2} \times P_{\text{total}}$  can be used to find partial pressure. The information given in ppm is a way of expressing the proportion, or fraction, of  $\text{SO}_2$  present in the mixture. Since  $n$  is directly proportional to  $V$ , the volume fraction can be used in place of the mole fraction,  $X_{\text{SO}_2}$ . There are  $7.95 \times 10^3$  parts  $\text{SO}_2$  in a million parts of mixture, so volume fraction =  $(7.95 \times 10^3 / 1 \times 10^6) = 7.95 \times 10^{-3}$ .

$$P_{\text{D}_2} = \text{volume fraction} \times P_{\text{total}} = (7.95 \times 10^{-3})(850. \text{ torr}) = 6.7575 = \mathbf{6.76 \text{ torr}}$$

- 5.48 Plan: First, write the balanced equation. Convert mass of  $\text{P}_4\text{S}_3$  to moles and use the molar ratio from the balanced equation to find the moles of  $\text{SO}_2$  gas produced. Use the ideal gas law to find the volume of that amount of  $\text{SO}_2$ . Pressure must be in units of atm and temperature in kelvins.

Solution:

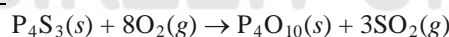

$$\text{Moles SO}_2 = (0.800 \text{ g P}_4\text{S}_3)\left(\frac{1 \text{ mol P}_4\text{S}_3}{220.09 \text{ g P}_4\text{S}_3}\right)\left(\frac{3 \text{ mol SO}_2}{1 \text{ mol P}_4\text{S}_3}\right) = 0.010905 \text{ mol SO}_2$$

Finding the volume of  $\text{SO}_2$ :

$$\begin{array}{ll} V = \text{unknown} & T = 32^\circ\text{C} + 273 = 305 \text{ K} \\ P = 725 \text{ torr} & n = 0.010905 \text{ mol} \end{array}$$

Converting  $P$  from torr to atm:  $P = (725 \text{ torr})\left(\frac{1 \text{ atm}}{760 \text{ torr}}\right) = 0.953947368 \text{ atm}$

$$PV = nRT$$

Solving for  $V$ :

$$V = \frac{nRT}{P} = \frac{(0.010905 \text{ mol})\left(0.0821 \frac{\text{L}\cdot\text{atm}}{\text{mol}\cdot\text{K}}\right)(305 \text{ K})}{(0.953947368 \text{ atm})} = 0.28624918 \text{ L}$$

Converting  $V$  from L to mL:

$$V = (0.28624918 \text{ L})\left(\frac{1 \text{ mL}}{10^{-3} \text{ L}}\right) = 286.249 = \mathbf{286 \text{ mL SO}_2}$$

- 5.49 Plan: First, write the balanced equation. Given the amount of xenon hexafluoride that reacts, we can find the number of moles of silicon tetrafluoride gas formed by using the molar ratio in the balanced equation. Then, using the ideal gas law with the moles of gas, the temperature, and the volume, we can calculate the pressure of the silicon tetrafluoride gas. Temperature must be in units of kelvins.

Solution:

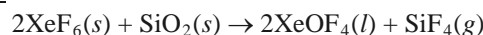

$$\text{Moles SiF}_4 = n = (2.00 \text{ g XeF}_6)\left(\frac{1 \text{ mol XeF}_6}{245.3 \text{ g XeF}_6}\right)\left(\frac{1 \text{ mol SiF}_4}{2 \text{ mol XeF}_6}\right) = 0.0040766 \text{ mol SiF}_4$$

Finding the pressure of  $\text{SiF}_4$ :

$V = 1.00 \text{ L}$   
 $P = \text{unknown}$   
 $PV = nRT$   
 Solving for  $P$ :

$$T = 25^\circ\text{C} + 273 = 298 \text{ K}$$

$$n = 0.0040766 \text{ mol}$$

$$\text{Pressure SiF}_4 = P = \frac{nRT}{V} = \frac{(0.0040766 \text{ mol SiF}_4) \left(0.0821 \frac{\text{L}\cdot\text{atm}}{\text{mol}\cdot\text{K}}\right) (298 \text{ K})}{1.00 \text{ L}} = 0.099737 = \mathbf{0.0997 \text{ atm SiF}_4}$$

5.50 Plan: Use the ideal gas law with  $T$  and  $P$  constant; then volume is directly proportional to moles.

Solution:

$PV = nRT$ . At constant  $T$  and  $P$ ,  $V \propto n$ . Since the volume of the products has been decreased to  $\frac{1}{2}$  the original volume, the moles (and molecules) must have been decreased by a factor of  $\frac{1}{2}$  as well. **Cylinder A** best represents the products as there are 2 product molecules (there were 4 reactant molecules).

5.51 Plan: Write the balanced equation. Since the amounts of 2 reactants are given, this is a limiting reactant problem. To find the volume of  $\text{SO}_2$ , use the molar ratios from the balanced equation to find the number of moles of  $\text{SO}_2$  produced by each reactant. The smaller number of moles of product indicates the limiting reagent. Solve for moles of  $\text{SO}_2$  using the ideal gas law.

Solution:

Moles of oxygen:

$$V = 228 \text{ L}$$

$$T = 220^\circ\text{C} + 273 = 493 \text{ K}$$

$$P = 2 \text{ atm}$$

$$n = \text{unknown}$$

$$PV = nRT$$

Solving for  $n$ :

$$\text{Moles of O}_2 = n = \frac{PV}{RT} = \frac{(2 \text{ atm})(228 \text{ L})}{\left(0.0821 \frac{\text{L}\cdot\text{atm}}{\text{mol}\cdot\text{K}}\right) (493 \text{ K})} = 11.266 \text{ mol O}_2$$

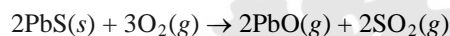

$$\text{Moles SO}_2 \text{ from O}_2 = (11.266 \text{ mol O}_2) \left(\frac{2 \text{ mol SO}_2}{3 \text{ mol O}_2}\right) = 7.5107 \text{ mol SO}_2$$

$$\text{Moles SO}_2 \text{ from PbS} = (3.75 \text{ kg PbS}) \left(\frac{10^3 \text{ g}}{1 \text{ kg}}\right) \left(\frac{1 \text{ mol PbS}}{239.3 \text{ g PbS}}\right) \left(\frac{2 \text{ mol SO}_2}{2 \text{ mol PbS}}\right) = 15.6707 \text{ mol SO}_2 \text{ (unrounded)}$$

$\text{O}_2$  is the limiting reagent because it forms less  $\text{SO}_2$ .

Finding the volume of  $\text{SO}_2$ :

$$V = \text{unknown}$$

$$T = 0^\circ\text{C} + 273 = 273 \text{ K}$$

$$P_{\text{total}} = 1 \text{ atm}$$

$$n = 7.5107 \text{ mol}$$

$$PV = nRT$$

Solving for  $V$ :

$$V = \frac{nRT}{P} = \frac{(7.5107 \text{ mol}) \left(0.0821 \frac{\text{L}\cdot\text{atm}}{\text{mol}\cdot\text{K}}\right) (273 \text{ K})}{(1 \text{ atm})} = 168.34 = \mathbf{1.7 \times 10^2 \text{ L SO}_2}$$

5.52 As the temperature of the gas sample increases, the most probable speed increases. This will increase both the number of collisions per unit time and the force of each collision with the sample walls. Thus, the gas pressure increases.

5.53 At STP (or any identical temperature and pressure), the volume occupied by a mole of any gas will be identical. One mole of krypton has the same number of particles as one mole of helium and, at the same temperature, all of the gas particles have the same average kinetic energy, resulting in the same pressure and volume.

5.54 Plan: The molar masses of the three gases are 2.016 for H<sub>2</sub> (Flask A), 4.003 for He (Flask B), and 16.04 for CH<sub>4</sub> (Flask C). Since hydrogen has the smallest molar mass of the three gases, 4 g of H<sub>2</sub> will contain more gas molecules (about 2 mole's worth) than 4 g of He or 4 g of CH<sub>4</sub>. Since helium has a smaller molar mass than methane, 4 g of He will contain more gas molecules (about 1 mole's worth) than 4 g of CH<sub>4</sub> (about 0.25 mole's worth).

Solution:

a)  $P_A > P_B > P_C$  The pressure of a gas is proportional to the number of gas molecules ( $PV = nRT$ ). So, the gas sample with more gas molecules will have a greater pressure.

b)  $E_A = E_B = E_C$  Average kinetic energy depends only on temperature. The temperature of each gas sample is 273 K, so they all have the same average kinetic energy.

c)  $\text{rate}_A > \text{rate}_B > \text{rate}_C$  When comparing the speed of two gas molecules, the one with the lower mass travels faster.

d)  $\text{total } E_A > \text{total } E_B > \text{total } E_C$  Since the average kinetic energy for each gas is the same (part b) of this problem), the total kinetic energy would equal the average times the number of molecules. Since the hydrogen flask contains the most molecules, its total kinetic energy will be the greatest.

e)  $d_A = d_B = d_C$  Under the conditions stated in this problem, each sample has the same volume, 5 L, and the same mass, 4 g. Thus, the density of each is 4 g/5 L = 0.8 g/L.

f) **Collision frequency (A) > collision frequency (B) > collision frequency (C)** The number of collisions depends on both the speed and the distance between gas molecules. Since hydrogen is the lightest molecule it has the greatest speed and the 5 L flask of hydrogen also contains the most molecules, so collisions will occur more frequently between hydrogen molecules than between helium molecules. By the same reasoning, collisions will occur more frequently between helium molecules than between methane molecules.

5.55 Plan: To find the ratio of effusion rates, calculate the inverse of the ratio of the square roots of the molar masses (Graham's law).

Solution:

$$\frac{\text{Rate H}_2}{\text{Rate UF}_6} = \sqrt{\frac{\text{molar mass UF}_6}{\text{molar mass H}_2}} = \sqrt{\frac{352.0 \text{ g/mol}}{2.016 \text{ g/mol}}} = 13.2137 = \mathbf{13.21}$$

5.56 Plan: To find the ratio of effusion rates, calculate the inverse of the ratio of the square roots of the molar masses (Graham's law).

Solution:

$$\frac{\text{Rate O}_2}{\text{Rate Kr}} = \sqrt{\frac{\text{molar mass Kr}}{\text{molar mass O}_2}} = \sqrt{\frac{83.80 \text{ g/mol}}{32.00 \text{ g/mol}}} = 1.618255 = \mathbf{1.618}$$

5.57 Plan: Recall that the heavier the gas, the slower the molecular speed. The molar mass of Ar is 39.95 g/mol while the molar mass of He is 4.003 g/mol.

Solution:

a) The gases have the same average kinetic energy because they are at the same temperature. The heavier Ar atoms are moving more slowly than the lighter He atoms to maintain the same average kinetic energy. Therefore, **Curve 1** with the lower average molecular speed, better represents the behavior of Ar.

b) A gas that has a slower molecular speed would effuse more slowly, so **Curve 1** is the better choice.

c) Fluorine gas exists as a diatomic molecule, F<sub>2</sub>, with  $\mathcal{M} = 38.00$  g/mol. Therefore, F<sub>2</sub> is much closer in mass to Ar (39.95 g/mol) than He (4.003 g/mol), so **Curve 1** more closely represents the behavior of F<sub>2</sub>.

5.58 Plan: Recall that the lower the temperature, the lower the average kinetic energy and the slower the molecular speed.

Solution:

a) At the lower temperature, the average molecular speed is lower so **Curve 1** represents the gas at the lower temperature.

b) When a gas has a higher kinetic energy, the molecules have a higher molecular speed. **Curve 2** with the larger average molecular speed represents the gas when it has a higher kinetic energy.

c) If a gas has a higher diffusion rate, then the gas molecules are moving with a higher molecular speed as in **Curve 2**.

- 5.59 **Plan:** To find the ratio of effusion rates, calculate the inverse of the ratio of the square roots of the molar masses (Graham's law). Then use the ratio of effusion rates to find the time for the F<sub>2</sub> effusion. Effusion rate and time required for the effusion are inversely proportional.

**Solution:**

$$\mathcal{M} \text{ of He} = 4.003 \text{ g/mol} \quad \mathcal{M} \text{ of F}_2 = 38.00 \text{ g/mol}$$

$$\frac{\text{Rate He}}{\text{Rate F}_2} = \sqrt{\frac{\text{molar mass F}_2}{\text{molar mass He}}} = \sqrt{\frac{38.00 \text{ g/mol}}{4.003 \text{ g/mol}}} = 3.08105 \text{ (unrounded)}$$

$$\frac{\text{Rate He}}{\text{Rate F}_2} = \frac{\text{time F}_2}{\text{time He}} \quad \frac{3.08105}{1.00} = \frac{\text{time F}_2}{4.85 \text{ min He}} \quad \text{Time F}_2 = 14.9431 = \mathbf{14.9 \text{ min}}$$

- 5.60 **Plan:** Effusion rate and time required for the effusion are inversely proportional. Therefore, time of effusion for a gas is directly proportional to the square root of its molar mass. The ratio of effusion times and the molar mass of H<sub>2</sub> are used to find the molar mass of the unknown gas.

**Solution:**

$$\mathcal{M} \text{ of H}_2 = 2.016 \text{ g/mol} \quad \text{Time of effusion of H}_2 = 2.42 \text{ min} \quad \text{Time of effusion of unknown} = 11.1$$

min

$$\frac{\text{rate H}_2}{\text{rate unknown}} = \frac{\text{time unknown}}{\text{time H}_2} = \sqrt{\frac{\text{molar mass unknown}}{\text{molar mass H}_2}}$$

$$\frac{11.1 \text{ min}}{2.42 \text{ min}} = \sqrt{\frac{\text{molar mass unknown}}{2.016 \text{ g/mol}}}$$

$$4.586777 = \sqrt{\frac{\text{molar mass unknown}}{2.016 \text{ g/mol}}}$$

$$21.03852196 = \frac{\text{molar mass unknown}}{2.016 \text{ g/mol}}$$

$$\text{Molar mass unknown} = 42.41366 = \mathbf{42.4 \text{ g/mol}}$$

- 5.61 **Plan:** White phosphorus is a molecular form of the element phosphorus consisting of some number, x, of phosphorus atoms; the number of atoms in a molecule determines the molar mass of the phosphorus molecule. Use the relative rates of effusion of white phosphorus and neon (Graham's law) to determine the molar mass of white phosphorus. From the molar mass of white phosphorus, determine the number of phosphorus atoms, x, in one molecule of white phosphorus.

**Solution:**

$$\mathcal{M} \text{ of Ne} = 20.18 \text{ g/mol}$$

$$\frac{\text{Rate P}_x}{\text{Rate Ne}} = 0.404 = \sqrt{\frac{\text{molar mass Ne}}{\text{molar mass P}_x}}$$

$$0.404 = \sqrt{\frac{20.18 \text{ g/mol}}{\text{molar mass P}_x}}$$

$$(0.404)^2 = \frac{20.18 \text{ g/mol}}{\text{molar mass P}_x}$$

$$0.163216 = \frac{20.18 \text{ g/mol}}{\text{molar mass P}_x}$$

$$\text{Molar mass P}_x = 123.6398 \text{ g/mol}$$

$$\left(\frac{123.6398 \text{ g}}{\text{mol P}_x}\right) \left(\frac{1 \text{ mol P}}{30.97 \text{ g P}}\right) = 3.992244 = 4 \text{ mol P/mol P}_x \quad \text{or 4 atoms P/molecule P}_x$$

Thus, **4 atoms per molecule**, so P<sub>x</sub> = P<sub>4</sub>.



- 5.62 Plan: Use the equation for root mean speed ( $u_{\text{rms}}$ ) to find this value for He at 0.°C and 30.°C and for Xe at 30.°C. The calculated root mean speed is then used in the kinetic energy equation to find the average kinetic energy for the two gases at 30.°C. Molar mass values must be in units of kg/mol and temperature in kelvins.  
Solution:

$$\text{a) } 0^\circ\text{C} = 273 \text{ K} \quad 30^\circ\text{C} + 273 = 303 \text{ K} \quad \mathcal{M} \text{ of He} = \left( \frac{4.003 \text{ g He}}{\text{mol}} \right) \left( \frac{1 \text{ kg}}{10^3 \text{ g}} \right) = 0.004003 \text{ kg/mol}$$

$$R = 8.314 \text{ J/mol}\cdot\text{K}$$

$$1 \text{ J} = \text{kg}\cdot\text{m}^2/\text{s}^2$$

$$u_{\text{rms}} = \sqrt{\frac{3RT}{\mathcal{M}}}$$

$$u_{\text{rms}} \text{ He (at } 0^\circ\text{C)} = \sqrt{\frac{3 \left( 8.314 \frac{\text{J}}{\text{mol}\cdot\text{K}} \right) (273 \text{ K}) \left( \frac{\text{kg}\cdot\text{m}^2/\text{s}^2}{\text{J}} \right)}{0.004003 \text{ kg/mol}}} = 1.3042 \times 10^3 = \mathbf{1.30 \times 10^3 \text{ m/s}}$$

$$u_{\text{rms}} \text{ He (at } 30^\circ\text{C)} = \sqrt{\frac{3 \left( 8.314 \frac{\text{J}}{\text{mol}\cdot\text{K}} \right) (303 \text{ K}) \left( \frac{\text{kg}\cdot\text{m}^2/\text{s}^2}{\text{J}} \right)}{0.004003 \text{ kg/mol}}} = 1.3740 \times 10^3 = \mathbf{1.37 \times 10^3 \text{ m/s}}$$

$$\text{b) } 30^\circ\text{C} + 273 = 303 \text{ K} \quad \mathcal{M} \text{ of Xe} = \left( \frac{131.3 \text{ g Xe}}{\text{mol}} \right) \left( \frac{1 \text{ kg}}{10^3 \text{ g}} \right) = 0.1313 \text{ kg/mol}$$

$$R = 8.314 \text{ J/mol}\cdot\text{K}$$

$$1 \text{ J} = \text{kg}\cdot\text{m}^2/\text{s}^2$$

$$u_{\text{rms}} = \sqrt{\frac{3RT}{\mathcal{M}}}$$

$$u_{\text{rms}} \text{ Xe (at } 30^\circ\text{C)} = \sqrt{\frac{3 \left( 8.314 \frac{\text{J}}{\text{mol}\cdot\text{K}} \right) (303 \text{ K}) \left( \frac{\text{kg}\cdot\text{m}^2/\text{s}^2}{\text{J}} \right)}{0.1313 \text{ kg/mol}}} = 239.913 \text{ m/s (unrounded)}$$

$$\text{Rate He/Rate Xe} = (1.3740 \times 10^3 \text{ m/s}) / (239.913 \text{ m/s}) = 5.727076 = \mathbf{5.73}$$

He molecules travel at almost 6 times the speed of Xe molecules.

$$\text{c) } E_k = \frac{1}{2} m u^2$$

$$E_{\text{He}} = \frac{1}{2} (0.004003 \text{ kg/mol}) (1.3740 \times 10^3 \text{ m/s})^2 \left( 1 \text{ J/kg}\cdot\text{m}^2/\text{s}^2 \right) = 3778.58 = \mathbf{3.78 \times 10^3 \text{ J/mol}}$$

$$E_{\text{Xe}} = \frac{1}{2} (0.1313 \text{ kg/mol}) (239.913 \text{ m/s})^2 \left( 1 \text{ J/kg}\cdot\text{m}^2/\text{s}^2 \right) = 3778.70 = \mathbf{3.78 \times 10^3 \text{ J/mol}}$$

$$\text{d) } \left( \frac{3778.58 \text{ J}}{\text{mol}} \right) \left( \frac{1 \text{ mol}}{6.022 \times 10^{23} \text{ atoms}} \right) = 6.2746 \times 10^{-21} = \mathbf{6.27 \times 10^{-21} \text{ J/He atom}}$$

- 5.63 Plan: Use Graham's law: the rate of effusion of a gas is inversely proportional to the square root of the molar mass. When comparing the speed of gas molecules, the one with the lowest mass travels the fastest.

Solution:

$$\text{a) } \mathcal{M} \text{ of } \text{S}_2\text{F}_2 = 102.14 \text{ g/mol}; \quad \mathcal{M} \text{ of } \text{N}_2\text{F}_4 = 104.02 \text{ g/mol}; \quad \mathcal{M} \text{ of } \text{SF}_4 = 108.07 \text{ g/mol}$$

$\text{SF}_4$  has the largest molar mass and  $\text{S}_2\text{F}_2$  has the smallest molar mass:  $\text{rate}_{\text{SF}_4} < \text{rate}_{\text{N}_2\text{F}_4} < \text{rate}_{\text{S}_2\text{F}_2}$

$$\text{b) } \frac{\text{Rate}_{\text{S}_2\text{F}_2}}{\text{Rate}_{\text{N}_2\text{F}_4}} = \sqrt{\frac{\text{molar mass } \text{N}_2\text{F}_4}{\text{molar mass } \text{S}_2\text{F}_2}} = \sqrt{\frac{104.02 \text{ g/mol}}{102.14 \text{ g/mol}}} = 1.009161 = \mathbf{1.0092:1}$$

$$\text{c) } \frac{\text{Rate X}}{\text{Rate } \text{SF}_4} = 0.935 = \sqrt{\frac{\text{molar mass } \text{SF}_4}{\text{molar mass X}}}$$

$$0.935 = \sqrt{\frac{108.07 \text{ g/mol}}{\text{molar mass X}}}$$

$$(0.935)^2 = \frac{108.07 \text{ g/mol}}{\text{molar mass X}}$$

$$0.874225 = \frac{108.07 \text{ g/mol}}{\text{molar mass X}}$$

$$\text{Molar mass X} = 123.61806 = \mathbf{124 \text{ g/mol}}$$

5.64 Interparticle attractions cause the real pressure to be *less than* ideal pressure, so it causes a **negative** deviation. The size of the interparticle attraction is related to the constant *a*. According to Table 5.4,  $a_{\text{N}_2} = 1.39$ ,  $a_{\text{Kr}} = 2.32$ , and  $a_{\text{CO}_2} = 3.59$ . Therefore,  $\text{CO}_2$  experiences a greater negative deviation in pressure than the other two gases:  $\mathbf{N_2 < Kr < CO_2}$ .

5.65 Particle volume causes a positive deviation from ideal behavior. Thus,  $V_{\text{Real Gases}} > V_{\text{Ideal Gases}}$ . The particle volume is related to the constant *b*. According to Table 5.4,  $b_{\text{H}_2} = 0.0266$ ,  $b_{\text{O}_2} = 0.0318$ , and  $b_{\text{Cl}_2} = 0.0562$ . Therefore, the order is  $\mathbf{H_2 < O_2 < Cl_2}$ .

5.66 Nitrogen gas behaves more ideally at **1 atm** than at 500 atm because at lower pressures the gas molecules are farther apart. An ideal gas is defined as consisting of gas molecules that act independently of the other gas molecules. When gas molecules are far apart they act more ideally, because intermolecular attractions are less important and the volume of the molecules is a smaller fraction of the container volume.

5.67  $\text{SF}_6$  behaves more ideally at **150°C**. At higher temperatures, intermolecular attractions become less important and the volume occupied by the molecules becomes less important.

5.68 Plan: Use the ideal gas law to find the number of moles of  $\text{O}_2$ . Moles of  $\text{O}_2$  is divided by 4 to find moles of Hb since  $\text{O}_2$  combines with Hb in a 4:1 ratio. Divide the given mass of Hb by the number of moles of Hb to obtain molar mass, g/mol. Temperature must be in units of kelvins, pressure in atm, and volume in L.

Solution:

$$V = 1.53 \text{ mL}$$

$$T = 37^\circ\text{C} + 273 = 310 \text{ K}$$

$$P = 743 \text{ torr}$$

$$n = \text{unknown}$$

$$\text{Converting } V \text{ from mL to L: } V = (1.53 \text{ mL}) \left( \frac{10^{-3} \text{ L}}{1 \text{ mL}} \right) = 1.53 \times 10^{-3} \text{ L}$$

$$\text{Converting } P \text{ from torr to atm: } P = (743 \text{ torr}) \left( \frac{1 \text{ atm}}{760 \text{ torr}} \right) = 0.977631578 \text{ atm}$$

$$PV = nRT$$

Solving for *n*:

$$\text{Moles of } \text{O}_2 = n = \frac{PV}{RT} = \frac{(0.977631578 \text{ atm})(1.53 \times 10^{-3} \text{ L})}{\left(0.0821 \frac{\text{L}\cdot\text{atm}}{\text{mol}\cdot\text{K}}\right)(310 \text{ K})} = 5.87708 \times 10^{-5} \text{ mol } \text{O}_2$$

$$\text{Moles Hb} = \left(5.87708 \times 10^{-5} \text{ mol } \text{O}_2\right) \left(\frac{1 \text{ mol Hb}}{4 \text{ mol } \text{O}_2}\right) = 1.46927 \times 10^{-5} \text{ mol Hb (unrounded)}$$

$$\text{Molar mass hemoglobin} = \frac{1.00 \text{ g Hb}}{1.46927 \times 10^{-5} \text{ Hb}} = 6.806098 \times 10^4 = \mathbf{6.81 \times 10^4 \text{ g/mol}}$$

5.69 Plan: First, write the balanced equations. Convert mass of  $\text{NaHCO}_3$  to moles and use the molar ratio from each balanced equation to find the moles of  $\text{CO}_2$  gas produced. Use the ideal gas law to find the volume of that amount of  $\text{CO}_2$ . Temperature must be in kelvins.

Solution:



$$\text{Moles CO}_2 = (1.00 \text{ g NaHCO}_3) \left( \frac{1 \text{ mol NaHCO}_3}{84.01 \text{ g NaHCO}_3} \right) \left( \frac{1 \text{ mol CO}_2}{2 \text{ mol NaHCO}_3} \right) = 5.95167 \times 10^{-3} \text{ mol CO}_2$$

Finding the volume of CO<sub>2</sub>:

V = unknown

$$T = 200.^\circ\text{C} + 273 = 473 \text{ K}$$

P = 0.975 atm

$$n = 5.95167 \times 10^{-3} \text{ mol}$$

PV = nRT

Solving for V:

$$\text{Volume of CO}_2 = V = \frac{nRT}{P} = \frac{(5.95167 \times 10^{-3} \text{ mol}) \left( 0.0821 \frac{\text{L}\cdot\text{atm}}{\text{mol}\cdot\text{K}} \right) (473 \text{ K})}{(0.975 \text{ atm})} = 0.237049 \text{ L}$$

Converting V from L to mL:

$$V = (0.237049 \text{ L}) \left( \frac{1 \text{ mL}}{10^{-3} \text{ L}} \right) = 237.049 = \mathbf{237 \text{ mL CO}_2} \text{ in Reaction 1}$$

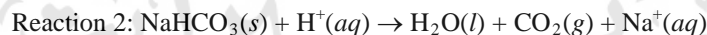

$$\text{Moles CO}_2 = (1.00 \text{ g NaHCO}_3) \left( \frac{1 \text{ mol NaHCO}_3}{84.01 \text{ g NaHCO}_3} \right) \left( \frac{1 \text{ mol CO}_2}{1 \text{ mol NaHCO}_3} \right) = 1.1903 \times 10^{-2} \text{ mol CO}_2$$

Finding the volume of CO<sub>2</sub>:

V = unknown

$$T = 200.^\circ\text{C} + 273 = 473 \text{ K}$$

P = 0.975 atm

$$n = 1.1903 \times 10^{-2} \text{ mol}$$

PV = nRT

Solving for V:

$$\text{Volume of CO}_2 = V = \frac{nRT}{P} = \frac{(1.1903 \times 10^{-2} \text{ mol}) \left( 0.0821 \frac{\text{L}\cdot\text{atm}}{\text{mol}\cdot\text{K}} \right) (473 \text{ K})}{(0.975 \text{ atm})} = 0.4740986 \text{ L}$$

Converting V from L to mL:

$$V = (0.4740986 \text{ L}) \left( \frac{1 \text{ mL}}{10^{-3} \text{ L}} \right) = 474.0986 = \mathbf{474 \text{ mL CO}_2} \text{ in Reaction 2}$$

- 5.70 Plan: Convert the mass of Cl<sub>2</sub> to moles and use the ideal gas law and van der Waals equation to find the pressure of the gas.

Solution:

$$\text{a) Moles Cl}_2: (0.5950 \text{ kg Cl}_2) \left( \frac{10^3 \text{ g}}{1 \text{ kg}} \right) \left( \frac{1 \text{ mol Cl}_2}{70.90 \text{ g Cl}_2} \right) = 8.3921016 \text{ mol}$$

V = 15.50 L

$$T = 225^\circ\text{C} + 273 = 498 \text{ K}$$

n = 8.3921016 mol

P = unknown

Ideal gas law: PV = nRT

Solving for P:

$$P_{\text{IGL}} = \frac{nRT}{V} = \frac{(8.3921016 \text{ mol}) \left( 0.0821 \frac{\text{L}\cdot\text{atm}}{\text{mol}\cdot\text{K}} \right) (498 \text{ K})}{15.50 \text{ L}} = 22.1366 = \mathbf{22.1 \text{ atm}}$$

$$\text{b) van der Waals equation: } \left( P + \frac{n^2 a}{V^2} \right) (V - nb) = nRT$$

Solving for P:

$$P_{\text{VDW}} = \frac{nRT}{V - nb} - \frac{n^2 a}{V^2} \quad \text{From Table 5.4: } a = 6.49 \frac{\text{atm}\cdot\text{L}^2}{\text{mol}^2}; \quad b = 0.0562 \frac{\text{L}}{\text{mol}}$$

$n = 8.3921016 \text{ mol}$  from part a)

$$P_{\text{VDW}} = \frac{(8.3921016 \text{ mol Cl}_2) \left( 0.0821 \frac{\text{L}\cdot\text{atm}}{\text{mol}\cdot\text{K}} \right) (498 \text{ K}) - (8.3921016 \text{ mol Cl}_2)^2 \left( 6.49 \frac{\text{atm}\cdot\text{L}^2}{\text{mol}^2} \right)}{15.50 \text{ L} - (8.3921016 \text{ mol Cl}_2) \left( 0.0562 \frac{\text{L}}{\text{mol}} \right) - (15.50 \text{ L})^2}$$

$$= 20.928855 = \mathbf{20.9 \text{ atm}}$$

5.71 Plan: Rearrange the formula  $PV = (m/\mathcal{M})RT$  to solve for molar mass. Convert the volume in mL to L. Temperature must be in Kelvin. To find the molecular formulas of I, II, III, and IV, assume 100 g of each sample so the percentages are numerically equivalent to the masses of each element. Convert each of the masses to moles by using the molar mass of each element involved. Divide all moles by the lowest number of moles and convert to whole numbers to determine the empirical formula. The empirical formula mass and the calculated molar mass will then relate the empirical formula to the molecular formula. For gas IV, use Graham's law to find the molar mass

Solution:

a)  $V = 750.0 \text{ mL}$        $T = 70.00^\circ\text{C} + 273.15 = 343.15 \text{ K}$   
 $m = 0.1000 \text{ g}$        $P = 0.05951 \text{ atm (I); } 0.07045 \text{ atm (II); } 0.05767 \text{ atm (III)}$   
 $\mathcal{M} = \text{unknown}$

Converting  $V$  from mL to L:  $V = (750.0 \text{ mL}) \left( \frac{10^{-3} \text{ L}}{1 \text{ mL}} \right) = 0.7500 \text{ L}$

$$PV = \left( \frac{m}{\mathcal{M}} \right) RT$$

Solving for molar mass,  $\mathcal{M}$ :

$$\text{Molar mass I} = \mathcal{M} = \frac{mRT}{PV} = \frac{(0.1000 \text{ g}) \left( 0.08206 \frac{\text{L}\cdot\text{atm}}{\text{mol}\cdot\text{K}} \right) (343.15 \text{ K})}{(0.05951 \text{ atm})(0.7500 \text{ L})} = 63.0905 = \mathbf{63.09 \text{ g I/mol}}$$

$$\text{Molar mass II} = \mathcal{M} = \frac{mRT}{PV} = \frac{(0.1000 \text{ g}) \left( 0.08206 \frac{\text{L}\cdot\text{atm}}{\text{mol}\cdot\text{K}} \right) (343.15 \text{ K})}{(0.07045 \text{ atm})(0.7500 \text{ L})} = 53.293 = \mathbf{53.29 \text{ g II/mol}}$$

$$\text{Molar mass III} = \mathcal{M} = \frac{mRT}{PV} = \frac{(0.1000 \text{ g}) \left( 0.08206 \frac{\text{L}\cdot\text{atm}}{\text{mol}\cdot\text{K}} \right) (343.15 \text{ K})}{(0.05767 \text{ atm})(0.7500 \text{ L})} = 65.10349 = \mathbf{65.10 \text{ g III/mol}}$$

b) % H in I =  $100\% - 85.63\% = 14.37\% \text{ H}$

% H in II =  $100\% - 81.10\% = 18.90\% \text{ H}$

% H in III =  $100\% - 82.98\% = 17.02\% \text{ H}$

Assume 100 g of each so the mass percentages are also the grams of the element.

I

$$\text{Moles B} = (85.63 \text{ g B}) \left( \frac{1 \text{ mol B}}{10.81 \text{ g B}} \right) = 7.921369 \text{ mol B (unrounded)}$$

$$\text{Moles H} = (14.37 \text{ g H}) \left( \frac{1 \text{ mol H}}{1.008 \text{ g H}} \right) = 14.25595 \text{ mol H (unrounded)}$$

$$\left( \frac{7.921369 \text{ mol B}}{7.921369 \text{ mol B}} \right) = 1.00 \quad \left( \frac{14.25595 \text{ mol H}}{7.921369 \text{ mol B}} \right) = 1.7997$$

The hydrogen value is not close enough to a whole number to round. Thus, both amounts need to be multiplied by the smallest value to get near whole numbers. This value is 5. Multiplying each value by 5

gives  $(1.00 \times 5) = 5$  for B and  $(1.7997 \times 5) = 9$  for H. The empirical formula is  $B_5H_9$ , which has a formula mass of 63.12 g/mol. The empirical formula mass is near the molecular mass from part a) (63.09 g/mol). Therefore, the empirical and molecular formulas are both  $B_5H_9$ .

II

$$\text{Moles B} = (81.10 \text{ g B}) \left( \frac{1 \text{ mol B}}{10.81 \text{ g B}} \right) = 7.50231 \text{ mol B (unrounded)}$$

$$\text{Moles H} = (18.90 \text{ g H}) \left( \frac{1 \text{ mol H}}{1.008 \text{ g H}} \right) = 18.750 \text{ mol H (unrounded)}$$

$$\left( \frac{7.50231 \text{ mol B}}{7.50231 \text{ mol B}} \right) = 1.00 \quad \left( \frac{18.750 \text{ mol H}}{7.50231 \text{ mol B}} \right) = 2.4992$$

The hydrogen value is not close enough to a whole number to round. Thus, both amounts need to be multiplied by the smallest value to get near whole numbers. This value is 2. Multiplying each value by 2 gives  $(1.00 \times 2) = 2$  for B and  $(2.4992 \times 2) = 5$  for H. The empirical formula is  $B_2H_5$ , which has a formula mass of 26.66 g/mol. Dividing the molecular formula mass from part a) by the empirical formula mass gives the relationship between the formulas:  $(53.29 \text{ g/mol}) / (26.66 \text{ g/mol}) = 2$ . The molecular formula is two times the empirical formula, or  $B_4H_{10}$ .

III

$$\text{Moles B} = (82.98 \text{ g B}) \left( \frac{1 \text{ mol B}}{10.81 \text{ g B}} \right) = 7.6762 \text{ mol B (unrounded)}$$

$$\text{Moles H} = (17.02 \text{ g H}) \left( \frac{1 \text{ mol H}}{1.008 \text{ g H}} \right) = 16.8849 \text{ mol H (unrounded)}$$

$$\left( \frac{7.6762 \text{ mol B}}{7.6762 \text{ mol B}} \right) = 1.00 \quad \left( \frac{16.8849 \text{ mol H}}{7.6762 \text{ mol B}} \right) = 2.2$$

The hydrogen value is not close enough to a whole number to round. Thus, both amounts need to be multiplied by the smallest value to get near whole numbers. This value is 5. Multiplying each value by 5 gives  $(1.00 \times 5) = 5$  for B and  $(2.2 \times 5) = 11$  for H. The empirical formula is  $B_5H_{11}$ , which has a formula mass of 65.14 g/mol. The empirical formula mass is near the molecular mass from part a). Therefore, the empirical and molecular formulas are both  $B_5H_{11}$ .

c)

$$\frac{\text{Rate SO}_2}{\text{Rate IV}} = \sqrt{\frac{\text{molar mass IV}}{\text{molar mass SO}_2}}$$

$$\left( \frac{250.0 \text{ mL}}{13.04 \text{ min}} \right) = 0.657318 = \sqrt{\frac{\text{molar mass IV}}{64.07 \text{ g/mol}}}$$

$$0.657318^2 = \frac{\text{molar mass IV}}{64.07 \text{ g/mol}}$$

$$\text{Molar mass IV} = 27.6825 = \mathbf{27.68 \text{ g/mol}}$$

$$\% \text{ H in IV} = 100\% - 78.14\% = 21.86\% \text{ H}$$

$$\text{Moles B} = (78.14 \text{ g B}) \left( \frac{1 \text{ mol B}}{10.81 \text{ g B}} \right) = 7.22849 \text{ mol B (unrounded)}$$

$$\text{Moles H} = (21.86 \text{ g H}) \left( \frac{1 \text{ mol H}}{1.008 \text{ g H}} \right) = 21.6865 \text{ mol H (unrounded)}$$

$$\left( \frac{7.22849 \text{ mol B}}{7.22849 \text{ mol B}} \right) = 1.00 \quad \left( \frac{21.6865 \text{ mol H}}{7.22849 \text{ mol B}} \right) = 3.00$$

The empirical formula is  $\text{BH}_3$ , which has a formula mass of 13.83 g/mol. Dividing the molecular formula mass by the empirical formula mass gives the relationship between the formulas:  $(27.68 \text{ g/mol})/(13.83 \text{ g/mol}) = 2$ . The molecular formula is two times the empirical formula, or  $\text{B}_2\text{H}_6$ .

- 5.72 Plan: Calculate the mole fraction of each gas; the partial pressure of each gas is directly proportional to its mole fraction so the gas with the highest mole fraction has the highest partial pressure. Remember that kinetic energy is directly proportional to Kelvin temperature.

Solution:

$$\text{a) } X_A = \frac{n_A}{n_{\text{total}}}$$

$$\text{I. } X_A = \frac{3 \text{ A particles}}{9 \text{ total particles}} = 0.33; \quad \text{II. } X_A = \frac{4 \text{ A particles}}{12 \text{ total particles}} = 0.33; \quad \text{III. } X_A = \frac{5 \text{ A particles}}{15 \text{ total particles}} = 0.33$$

The partial pressure of A is the same in all 3 samples since the mole fraction of A is the same in all samples.

$$\text{b) I. } X_B = \frac{3 \text{ B particles}}{9 \text{ total particles}} = 0.33; \quad \text{II. } X_B = \frac{3 \text{ B particles}}{12 \text{ total particles}} = 0.25; \quad \text{III. } X_B = \frac{3 \text{ B particles}}{15 \text{ total particles}} = 0.20$$

The partial pressure of B is lowest in **Sample III** since the mole fraction of B is the smallest in that sample.

c) All samples are at the same temperature,  $T$ , so all have the same average kinetic energy.

- 5.73 Plan: Partial pressures and mole fractions are calculated from Dalton's law of partial pressures:  $P_A = X_A \times P_{\text{total}}$ . Remember that 1 atm = 760 torr. Solve the ideal gas law for moles and then convert to molecules using Avogadro's number to calculate the number of  $\text{O}_2$  molecules in the volume of an average breath.

Solution:

a) Convert each mole percent to a mole fraction by dividing by 100%.  $P_{\text{total}} = 1 \text{ atm} = 760 \text{ torr}$

$$P_{\text{Nitrogen}} = X_{\text{Nitrogen}} \times P_{\text{total}} = 0.786 \times 760 \text{ torr} = 597.36 = \mathbf{597 \text{ torr } N_2}$$

$$P_{\text{Oxygen}} = X_{\text{Oxygen}} \times P_{\text{total}} = 0.209 \times 760 \text{ torr} = 158.84 = \mathbf{159 \text{ torr } O_2}$$

$$P_{\text{Carbon Dioxide}} = X_{\text{Carbon Dioxide}} \times P_{\text{total}} = 0.0004 \times 760 \text{ torr} = 0.304 = \mathbf{0.3 \text{ torr } CO_2}$$

$$P_{\text{Water}} = X_{\text{Water}} \times P_{\text{total}} = 0.0046 \times 760 \text{ torr} = 3.496 = \mathbf{3.5 \text{ torr } H_2O}$$

b) Mole fractions can be calculated by rearranging Dalton's law of partial pressures:

$$X_A = \frac{P_A}{P_{\text{total}}} \text{ and multiply by 100 to express mole fraction as percent}$$

$$P_{\text{total}} = 1 \text{ atm} = 760 \text{ torr}$$

$$X_{\text{Nitrogen}} = \frac{597 \text{ torr}}{760 \text{ torr}} \times 100\% = 74.8684 = \mathbf{74.9 \text{ mol\% } N_2}$$

$$X_{\text{Oxygen}} = \frac{159 \text{ torr}}{760 \text{ torr}} \times 100\% = 13.6842 = \mathbf{13.7 \text{ mol\% } O_2}$$

$$X_{\text{Carbon Dioxide}} = \frac{0.3 \text{ torr}}{760 \text{ torr}} \times 100\% = 5.263 = \mathbf{5.3 \text{ mol\% } CO_2}$$

$$X_{\text{Water}} = \frac{3.5 \text{ torr}}{760 \text{ torr}} \times 100\% = 6.1842 = \mathbf{6.2 \text{ mol\% } H_2O}$$

c)  $V = 0.50 \text{ L}$        $T = 37^\circ\text{C} + 273 = 310 \text{ K}$

$P = 104 \text{ torr}$        $n = \text{unknown}$

$$\text{Converting } P \text{ from torr to atm: } P = (104 \text{ torr}) \left( \frac{1 \text{ atm}}{760 \text{ torr}} \right) = 0.136842105 \text{ atm}$$

$$PV = nRT$$

Solving for  $n$ :

$$n = \frac{PV}{RT} = \frac{(0.136842105 \text{ atm})(0.50 \text{ L})}{\left(0.0821 \frac{\text{L}\cdot\text{atm}}{\text{mol}\cdot\text{K}}\right)(310 \text{ K})} = 0.0026883 \text{ mol } O_2$$

$$\begin{aligned} \text{Molecules of O}_2 &= (0.0026883 \text{ mol O}_2) \left( \frac{6.022 \times 10^{23} \text{ molecules O}_2}{1 \text{ mol O}_2} \right) \\ &= 1.6189 \times 10^{21} = \mathbf{1.6 \times 10^{21} \text{ molecules O}_2} \end{aligned}$$

- 5.74 Plan: Convert the mass of Ra to moles and then atoms using Avogadro's number. Convert from number of Ra atoms to Rn atoms produced per second and then to Rn atoms produced per day. The number of Rn atoms is converted to moles and then the ideal gas law is used to find the volume of this amount of Rn.

Solution:

$$\text{Atoms Ra} = (1.0 \text{ g Ra}) \left( \frac{1 \text{ mol Ra}}{226 \text{ g Ra}} \right) \left( \frac{6.022 \times 10^{23} \text{ Ra atoms}}{1 \text{ mol Ra}} \right) = 2.664602 \times 10^{21} \text{ Ra atoms}$$

$$\text{Atoms Rn produced/s} = (2.664602 \times 10^{21} \text{ Ra atoms}) \left( \frac{1.373 \times 10^4 \text{ Rn atoms}}{1.0 \times 10^{15} \text{ Ra atoms}} \right) = 3.65849855 \times 10^{10} \text{ Rn atoms/s}$$

$$\begin{aligned} \text{Moles Rn produced/day} &= \left( \frac{3.65849855 \times 10^{10} \text{ Rn atoms}}{\text{s}} \right) \left( \frac{3600 \text{ s}}{\text{h}} \right) \left( \frac{24 \text{ h}}{\text{day}} \right) \left( \frac{1 \text{ mol Rn}}{6.022 \times 10^{23} \text{ Rn atoms}} \right) \\ &= 5.248992 \times 10^{-9} \text{ mole Rn/day} \end{aligned}$$

$PV = nRT$

Solving for  $V$  (at STP):

$$\begin{aligned} \text{Volume of Rn} = V &= \frac{nRT}{P} = \frac{(5.248992 \times 10^{-9} \text{ mol}) \left( 0.0821 \frac{\text{L} \cdot \text{atm}}{\text{mol} \cdot \text{K}} \right) (273 \text{ K})}{(1 \text{ atm})} \\ &= 1.17647 \times 10^{-7} = \mathbf{1.2 \times 10^{-7} \text{ L Rn}} \end{aligned}$$

- 5.75 Plan: For part a), since the volume, temperature, and pressure of the gas are changing, use the combined gas law. For part b), use the ideal gas law to solve for moles of air and then moles of  $\text{N}_2$ .

Solution:

a) $P_1 = 1450. \text{ mmHg}$	$P_2 = 1 \text{ atm}$
$V_1 = 208 \text{ mL}$	$V_2 = \text{unknown}$
$T_1 = 286 \text{ K}$	$T_2 = 298 \text{ K}$

$$\text{Converting } P_1 \text{ from mmHg to atm: } P_1 = (1450. \text{ mmHg}) \left( \frac{1 \text{ atm}}{760 \text{ mmHg}} \right) = 1.9079 \text{ atm}$$

Arranging the ideal gas law and solving for  $V_2$ :

$$\frac{P_1 V_1}{T_1} = \frac{P_2 V_2}{T_2}$$

$$V_2 = V_1 \left( \frac{T_2}{T_1} \right) \left( \frac{P_1}{P_2} \right) = (208 \text{ L}) \left( \frac{298 \text{ K}}{286 \text{ K}} \right) \left( \frac{1.9079 \text{ atm}}{1 \text{ atm}} \right) = 413.494 \text{ mL} = \mathbf{4 \times 10^2 \text{ mL}}$$

b) $V = 208 \text{ mL}$	$T = 286 \text{ K}$
$P = 1450 \text{ mmHg} = 1.9079 \text{ atm}$	$n = \text{unknown}$

$$\text{Converting } V \text{ from mL to L: } V = (208 \text{ mL}) \left( \frac{10^{-3} \text{ L}}{1 \text{ mL}} \right) = 0.208 \text{ L}$$

$PV = nRT$

Solving for  $n$ :

$$\text{Moles of air} = n = \frac{PV}{RT} = \frac{(1.9079 \text{ atm})(0.208 \text{ L})}{\left( 0.0821 \frac{\text{L} \cdot \text{atm}}{\text{mol} \cdot \text{K}} \right) (286 \text{ K})} = 0.016901 \text{ mol air}$$

$$\text{Mole of N}_2 = (0.016901 \text{ mol}) \left( \frac{77\% \text{ N}_2}{100\%} \right) = 0.01301 = \mathbf{0.013 \text{ mol N}_2}$$

5.76 Plan: The amounts of both reactants are given, so the first step is to identify the limiting reactant. Write the balanced equation and use molar ratios to find the number of moles of NO<sub>2</sub> produced by each reactant. The smaller number of moles of product indicates the limiting reagent. Solve for volume of NO<sub>2</sub> using the ideal gas law.

Solution:



$$\text{Moles NO}_2 \text{ from Cu} = (4.95 \text{ cm}^3) \left( \frac{8.95 \text{ g Cu}}{\text{cm}^3} \right) \left( \frac{1 \text{ mol Cu}}{63.55 \text{ g Cu}} \right) \left( \frac{2 \text{ mol NO}_2}{1 \text{ mol Cu}} \right) = 1.394256 \text{ mol NO}_2$$

$$\begin{aligned} \text{Moles NO}_2 \text{ from HNO}_3 &= (230.0 \text{ mL}) \left( \frac{68.0\% \text{ HNO}_3}{100\%} \right) \left( \frac{1 \text{ cm}^3}{1 \text{ mL}} \right) \left( \frac{1.42 \text{ g}}{\text{cm}^3} \right) \left( \frac{1 \text{ mol HNO}_3}{63.02 \text{ g}} \right) \left( \frac{2 \text{ mol NO}_2}{4 \text{ mol HNO}_3} \right) \\ &= 1.7620 \text{ mol NO}_2 \end{aligned}$$

Since less product can be made from the copper, it is the limiting reactant and excess nitric acid will be left after the reaction goes to completion. Use the calculated number of moles of NO<sub>2</sub> and the given temperature and pressure in the ideal gas law to find the volume of nitrogen dioxide produced. Note that nitrogen dioxide is the only gas involved in the reaction.

$V = \text{unknown}$

$$T = 28.2^\circ\text{C} + 273.2 = 301.4 \text{ K}$$

$P = 735 \text{ torr}$

$$n = 1.394256 \text{ mol NO}_2$$

Converting  $P$  from torr to atm:

$$P = (735 \text{ torr}) \left( \frac{1 \text{ atm}}{760 \text{ torr}} \right) = 0.967105 \text{ atm}$$

$$PV = nRT$$

Solving for  $V$ :

$$V = \frac{nRT}{P} = \frac{(1.394256 \text{ mol}) \left( 0.0821 \frac{\text{L}\cdot\text{atm}}{\text{mol}\cdot\text{K}} \right) (301.4 \text{ K})}{(0.967105 \text{ atm})} = 35.67429 = \mathbf{35.7 \text{ L NO}_2}$$

5.77 Plan: First, write the balanced equation. Convert mass of NaN<sub>3</sub> to moles and use the molar ratio from the balanced equation to find the moles of nitrogen gas produced. Use the ideal gas law to find the volume of that amount of nitrogen. The problem specifies that the nitrogen gas is collected over water, so the partial pressure of water vapor must be subtracted from the overall pressure given. Table 5.2 reports the vapor pressure of water at 26°C (25.2 torr). Pressure must be in units of atm and temperature in kelvins.

Solution:



$$\text{Moles N}_2 = (50.0 \text{ g NaN}_3) \left( \frac{1 \text{ mol NaN}_3}{65.02 \text{ g NaN}_3} \right) \left( \frac{3 \text{ mol N}_2}{2 \text{ mol NaN}_3} \right) = 1.15349 \text{ mol N}_2$$

Finding the volume of N<sub>2</sub>:

$V = \text{unknown}$

$$T = 26^\circ\text{C} + 273 = 299 \text{ K}$$

$P_{\text{total}} = 745.5 \text{ mmHg}$

$$n = 1.15319 \text{ mol}$$

$P_{\text{water vapor}} = 25.2 \text{ torr} = 25.2 \text{ mmHg}$

$P_{\text{nitrogen}} = P_{\text{total}} - P_{\text{water vapor}} = 745.5 \text{ mmHg} - 25.2 \text{ mmHg} = 720.3 \text{ mmHg}$

$$\text{Converting } P \text{ from mmHg to atm: } P = (720.3 \text{ mmHg}) \left( \frac{1 \text{ atm}}{760 \text{ mmHg}} \right) = 0.9477632 \text{ atm}$$

$$PV = nRT$$

Solving for  $V$ :

$$V = \frac{nRT}{P} = \frac{(1.15349 \text{ mol}) \left( 0.0821 \frac{\text{L}\cdot\text{atm}}{\text{mol}\cdot\text{K}} \right) (299 \text{ K})}{(0.9477632 \text{ atm})} = 29.8764 = \mathbf{29.9 \text{ L N}_2}$$



- 5.78 Plan: Use the percent composition information to find the empirical formula of the compound. Assume 100 g of sample so the percentages are numerically equivalent to the masses of each element. Convert each of the masses to moles by using the molar mass of each element involved. Divide all moles by the lowest number of moles and convert to whole numbers to determine the empirical formula. Rearrange the formula  $PV = (m/M)RT$  to solve for molar mass. The empirical formula mass and the calculated molar mass will then relate the empirical formula to the molecular formula.

Solution:

Empirical formula:

Assume 100 g of each so the mass percentages are also the grams of the element.

$$\text{Moles C} = (64.81 \text{ g C}) \left( \frac{1 \text{ mol C}}{12.01 \text{ g C}} \right) = 5.39634 \text{ mol C}$$

$$\text{Moles H} = (13.60 \text{ g H}) \left( \frac{1 \text{ mol H}}{1.008 \text{ g H}} \right) = 13.49206 \text{ mol H}$$

$$\text{Moles O} = (21.59 \text{ g O}) \left( \frac{1 \text{ mol O}}{16.00 \text{ g O}} \right) = 1.349375 \text{ mol O}$$

$$\left( \frac{5.39634 \text{ mol C}}{1.349375 \text{ mol O}} \right) = 4 \quad \left( \frac{13.749206 \text{ mol H}}{1.349375 \text{ mol O}} \right) = 10 \quad \left( \frac{1.349375 \text{ mol O}}{1.349375 \text{ mol O}} \right) = 1.00$$

Empirical formula =  $\text{C}_4\text{H}_{10}\text{O}$  (empirical formula mass = 74.12 g/mol)

Molecular formula:

$$V = 2.00 \text{ mL}$$

$$T = 25^\circ\text{C} + 273 = 298 \text{ K}$$

$$m = 2.57 \text{ g}$$

$$P = 0.420 \text{ atm}$$

$M$  = unknown

$$PV = \left( \frac{m}{M} \right) RT$$

Solving for molar mass,  $M$ :

$$\text{Molar mass} = M = \frac{mRT}{PV} = \frac{(2.57 \text{ g}) \left( 0.0821 \frac{\text{L}\cdot\text{atm}}{\text{mol}\cdot\text{K}} \right) (298 \text{ K})}{(0.420 \text{ atm})(2.00 \text{ L})} = 74.85 \text{ g/mol}$$

Since the molar mass (74.85 g/mol) and the empirical formula mass (74.12 g/mol) are similar, the empirical and molecular formulas must both be:  $\text{C}_4\text{H}_{10}\text{O}$

- 5.79 Plan: The empirical formula for aluminum chloride is  $\text{AlCl}_3$  ( $\text{Al}^{3+}$  and  $\text{Cl}^-$ ). The empirical formula mass is (133.33 g/mol). Calculate the molar mass of the gaseous species from the ratio of effusion rates (Graham's law). This molar mass, divided by the empirical weight, should give a whole-number multiple that will yield the molecular formula.

Solution:

$$\frac{\text{Rate unknown}}{\text{Rate He}} = 0.122 = \sqrt{\frac{\text{molar mass He}}{\text{molar mass unknown}}}$$

$$0.122 = \sqrt{\frac{4.003 \text{ g/mol}}{\text{molar mass unknown}}}$$

$$0.014884 = \frac{4.003 \text{ g/mol}}{\text{molar mass unknown}}$$

$$\text{Molar mass unknown} = 268.9465 \text{ g/mol}$$

The whole-number multiple is  $268.9465/133.33$ , which is about 2. Therefore, the molecular formula of the gaseous species is  $2 \times (\text{AlCl}_3) = \text{Al}_2\text{Cl}_6$ .

- 5.80 Plan: First, write the balanced equation for the reaction:  $2\text{SO}_2 + \text{O}_2 \rightarrow 2\text{SO}_3$ . The total number of moles of gas will change as the reaction occurs since 3 moles of reactant gas forms 2 moles of product gas. From the volume, temperature, and pressures given, we can calculate the number of moles of gas before and after the reaction using the ideal gas law. For each mole of  $\text{SO}_3$  formed, the total number of moles of gas decreases by 1/2 mole. Thus, twice the decrease in moles of gas equals the moles of  $\text{SO}_3$  formed.

Solution:

Moles of gas before and after reaction:

$$V = 2.00 \text{ L}$$

$$T = 800. \text{ K}$$

$$P_{\text{total}} = 1.90 \text{ atm}$$

$$n = \text{unknown}$$

$$PV = nRT$$

$$\text{Initial moles} = n = \frac{PV}{RT} = \frac{(1.90 \text{ atm})(2.00 \text{ L})}{\left(0.0821 \frac{\text{L}\cdot\text{atm}}{\text{mol}\cdot\text{K}}\right)(800. \text{ K})} = 0.05785627 \text{ mol}$$

$$\text{Final moles} = n = \frac{PV}{RT} = \frac{(1.65 \text{ atm})(2.00 \text{ L})}{\left(0.0821 \frac{\text{L}\cdot\text{atm}}{\text{mol}\cdot\text{K}}\right)(800. \text{ K})} = 0.050243605 \text{ mol}$$

$$\begin{aligned} \text{Moles of } \text{SO}_3 \text{ produced} &= 2 \times \text{decrease in the total number of moles} \\ &= 2 \times (0.05785627 \text{ mol} - 0.050243605 \text{ mol}) \\ &= 0.01522533 = \mathbf{1.52 \times 10^{-2} \text{ mol}} \end{aligned}$$

Check: If the starting amount is 0.0578 total moles of  $\text{SO}_2$  and  $\text{O}_2$ , then  $x + y = 0.0578 \text{ mol}$ , where  $x = \text{mol of } \text{SO}_2$  and  $y = \text{mol of } \text{O}_2$ . After the reaction:

$$(x - z) + (y - 0.5z) + z = 0.0502 \text{ mol}$$

Where  $z = \text{mol of } \text{SO}_3 \text{ formed} = \text{mol of } \text{SO}_2 \text{ reacted} = 2(\text{mol of } \text{O}_2 \text{ reacted})$ .

Subtracting the two equations gives:

$$x - (x - z) + y - (y - 0.5z) - z = 0.0578 - 0.0502$$

$$z = 0.0152 \text{ mol } \text{SO}_3$$

The approach of setting up two equations and solving them gives the same result as above.

- 5.81 Plan: Use the density of  $\text{C}_2\text{H}_4$  to find the volume of one mole of gas. Then use the van der Waals equation with 1.00 mol of gas to find the pressure of the gas (the mole ratio is 1:1, so the number of moles of gas remains the same).

Solution:

$$\text{a) } (1 \text{ mole } \text{C}_2\text{H}_4) \left( \frac{28.05 \text{ g } \text{C}_2\text{H}_4}{1 \text{ mole } \text{C}_2\text{H}_4} \right) \left( \frac{1 \text{ mL}}{0.215 \text{ g}} \right) \left( \frac{10^{-3} \text{ L}}{1 \text{ mL}} \right) = 0.130465 \text{ L} = 0.130 \text{ L}$$

$$V = 0.130 \text{ L}$$

$$T = 10^\circ\text{C} + 273 = 283 \text{ K} + 950 \text{ K} = 1233 \text{ K}$$

$$P_{\text{total}} = \text{unknown}$$

$$n = 1.00 \text{ mol}$$

$$\text{From Table 5.4 for } \text{CH}_4: a = 2.25 \frac{\text{atm}\cdot\text{L}^2}{\text{mol}^2}; b = 0.0428 \frac{\text{L}}{\text{mol}}$$

$$\left( P + \frac{n^2 a}{V^2} \right) (V - nb) = nRT$$

$$\text{Pressure of } \text{CH}_4 = P_{\text{VDW}} = \frac{nRT}{V - nb} - \frac{n^2 a}{V^2}$$

$$P_{\text{VDW}} = \frac{(1.00 \text{ mol}) \left( 0.0821 \frac{\text{L}\cdot\text{atm}}{\text{mol}\cdot\text{K}} \right) (1233 \text{ K})}{0.130 \text{ L} - 1.00 \text{ mol} (0.0428 \text{ L/mol})} - \frac{(1.00 \text{ mol})^2 \left( 2.25 \frac{\text{atm}\cdot\text{L}^2}{\text{mol}^2} \right)}{(0.130 \text{ L})^2} = 1027.7504 = \mathbf{1028 \text{ atm}}$$

$$\text{b) } \frac{PV}{RT} = \frac{(1028 \text{ atm})(0.130 \text{ L})}{\left( 0.0821 \frac{\text{L}\cdot\text{atm}}{\text{mol}\cdot\text{K}} \right) (1233 \text{ K})} = \mathbf{1.32}$$

This value is smaller than that shown in Figure 5.23 for CH<sub>4</sub>. The temperature in this situation is very high (1233 K). At high temperatures, the gas particles have high kinetic energy. Thus the gas particles have the energy to overcome the effects of intermolecular attraction and the gas behaves more ideally.

- 5.82 Plan: Write a balanced equation for the reaction. Use the mole ratio of the product gases and the total pressure of the mixture to find the partial pressure of each gas. Use the ideal gas law with the partial pressure of either product gas to find the moles of that gas produced; the mole ratio between product gas and reactant allows calculation of the mass of original reactant.

Solution:

The reaction is:  $2 \text{NCl}_3(l) \xrightarrow{\Delta} \text{N}_2(g) + 3 \text{Cl}_2(g)$

The decomposition of all the NCl<sub>3</sub> means that the final pressure must be due to the N<sub>2</sub> and the Cl<sub>2</sub>. The product gases are present at a 1:3 ratio, and the total moles are 4.

a) Partial pressure N<sub>2</sub> = P<sub>nitrogen</sub> = X<sub>nitrogen</sub> P<sub>total</sub> = (1 mol N<sub>2</sub>/4 mol total) (754 mmHg)  
= 188.5 = **188 mmHg N<sub>2</sub>**

Partial pressure Cl<sub>2</sub> = P<sub>nitrogen</sub> = X<sub>nitrogen</sub> P<sub>total</sub> = (3 mol Cl<sub>2</sub>/4 mol total) (754 mmHg) = 565.5 = **566 mmHg Cl<sub>2</sub>**

b) The mass of NCl<sub>3</sub> may be determined several ways. Using the partial pressure of Cl<sub>2</sub> gives:

$$\text{Moles Cl}_2 = n = \frac{PV}{RT} = \frac{(565.5 \text{ mmHg})(2.50 \text{ L}) \left( \frac{1 \text{ atm}}{760 \text{ mmHg}} \right)}{\left( 0.0821 \frac{\text{L}\cdot\text{atm}}{\text{mol}\cdot\text{K}} \right) ((273 + 95) \text{ K})} = 0.0615698 \text{ mol Cl}_2$$

$$\text{Mass NCl}_3 = (0.0615698 \text{ mol Cl}_2) \left( \frac{2 \text{ mol NCl}_3}{3 \text{ mol Cl}_2} \right) \left( \frac{120.36 \text{ g NCl}_3}{1 \text{ mol NCl}_3} \right) = 4.94036 = \mathbf{4.94 \text{ g NCl}_3}$$

- 5.83 Plan: Use the percent composition information to find the empirical formula of the compound. Assume 100 g of sample so the percentages are numerically equivalent to the masses of each element. Convert each of the masses to moles by using the molar mass of each element involved. Divide all moles by the lowest number of moles and convert to whole numbers to determine the empirical formula. Rearrange the formula  $PV = (m/M)RT$  to solve for molar mass. The empirical formula mass and the calculated molar mass will then relate the empirical formula to the molecular formula.

Solution:

Empirical formula:

Assume 100 g of each so the mass percentages are also the grams of the element.

$$\text{Moles Si} = (33.01 \text{ g Si}) \left( \frac{1 \text{ mol Si}}{28.09 \text{ g Si}} \right) = 1.17515 \text{ mol Si}$$

$$\text{Moles F} = (66.99 \text{ g F}) \left( \frac{1 \text{ mol F}}{19.00 \text{ g F}} \right) = 3.525789 \text{ mol F}$$

$$\left( \frac{1.17515 \text{ mol Si}}{1.17515 \text{ mol Si}} \right) = 1 \quad \left( \frac{3.525789 \text{ mol F}}{1.17515 \text{ mol Si}} \right) = 3$$

Empirical formula = SiF<sub>3</sub> (empirical formula mass = 85.1 g/mol)

Molecular formula:

$$V = 0.250 \text{ L}$$

$$T = 27^\circ\text{C} + 273 = 300 \text{ K}$$

$$m = 2.60 \text{ g}$$

$$P = 1.50 \text{ atm}$$

$\mathcal{M}$  = unknown

$$PV = \left( \frac{m}{\mathcal{M}} \right) RT$$

Solving for molar mass,  $\mathcal{M}$ :

$$\text{Molar mass} = \mathcal{M} = \frac{mRT}{PV} = \frac{(2.60 \text{ g}) \left( 0.0821 \frac{\text{L}\cdot\text{atm}}{\text{mol}\cdot\text{K}} \right) (300 \text{ K})}{(1.50 \text{ atm})(0.250 \text{ L})} = 170.768 \text{ g/mol}$$

The molar mass (170.768 g/mol) is twice the empirical formula mass (85.1 g/mol), so the molecular formula must be twice the empirical formula, or  $2 \times \text{SiF}_3 = \text{Si}_2\text{F}_6$ .

- 5.84 Plan: Four moles of gas ( $\text{NH}_3$ ,  $\text{CO}$ ,  $\text{N}_2$ , and  $\text{HCNO}$ ) are formed from the decomposition of 1 mole of azodicarbonamide. Two of those moles of gas,  $\text{NH}_3$  and  $\text{HCNO}$ , further react to form solid nonvolatile polymers. So the decomposition of 1 mole of azodicarbonamide leads to the overall formation of two moles of gas. Convert the given mass of azodicarbonamide to moles and multiply by 2 to find the number of moles of gas produced. Use the ideal gas law to find the volume of that amount of gas at STP.

Solution:

$$\text{Moles of gas formed} = (1.00 \text{ g } \text{C}_2\text{H}_4\text{N}_4\text{O}_2) \left( \frac{1 \text{ mol } \text{C}_2\text{H}_4\text{N}_4\text{O}_2}{116.09 \text{ g } \text{C}_2\text{H}_4\text{N}_4\text{O}_2} \right) \left( \frac{2 \text{ moles of gas}}{1 \text{ mol } \text{C}_2\text{H}_4\text{N}_4\text{O}_2} \right) = 0.017228 \text{ mol}$$

$$\text{Volume (L) of gas} = V = \frac{nRT}{P} = \frac{(0.017228 \text{ mol}) \left( 0.0821 \frac{\text{L}\cdot\text{atm}}{\text{mol}\cdot\text{K}} \right) (273 \text{ K})}{(1.00 \text{ atm})} = 0.386136 \text{ L}$$

Converting  $V$  from L to mL:

$$V = (0.386136 \text{ L}) \left( \frac{1 \text{ mL}}{10^{-3} \text{ L}} \right) = 386.136 = \mathbf{386 \text{ mL gas}}$$

- 5.85 Plan: Write a balanced reaction based on the information given about the volumes of gases produced. Since the volume of a gas is proportional to the number of moles of the gas we can equate volume and moles.

Solution:

a) A preliminary equation for this reaction is  $4\text{C}_x\text{H}_y\text{N}_z + n\text{O}_2 \rightarrow 4\text{CO}_2 + 2\text{N}_2 + 10\text{H}_2\text{O}$ .

Since the organic compound does not contain oxygen, the only source of oxygen as a reactant is oxygen gas. To form 4 volumes of  $\text{CO}_2$  would require 4 volumes of  $\text{O}_2$  and to form 10 volumes of  $\text{H}_2\text{O}$  would require 5 volumes of  $\text{O}_2$ . Thus, 9 **volumes of  $\text{O}_2$**  were required.

b) From a volume ratio of  $4\text{CO}_2:2\text{N}_2:10\text{H}_2\text{O}$  we deduce a mole ratio of  $4\text{C}:4\text{N}:20\text{H}$  or  $1\text{C}:1\text{N}:5\text{H}$  for an empirical formula of  **$\text{CH}_5\text{N}$** .

- 5.86 a) There is a total of  $6 \times 10^6$  blue particles and  $6 \times 10^6$  black particles. When equilibrium is reached after opening the stopcocks, the particles will be evenly distributed among the three containers. Therefore, container B will have  **$2 \times 10^6$  blue particles and  $2 \times 10^6$  black particles**.
- b) The particles are evenly distributed so container A has  **$2 \times 10^6$  blue particles and  $2 \times 10^6$  black particles**.
- c) There are  $2 \times 10^6$  blue particles and  $2 \times 10^6$  black particles in C for a total of  $4 \times 10^6$  particles.

$$\text{Final pressure in C} = \left( 4 \times 10^6 \text{ particles} \right) \left( \frac{750 \text{ torr}}{6 \times 10^6 \text{ particles}} \right) = \mathbf{500 \text{ torr}}$$

d) There are  $2 \times 10^6$  blue particles and  $2 \times 10^6$  black particles in B for a total of  $4 \times 10^6$  particles.

$$\text{Final pressure in B} = \left( 4 \times 10^6 \text{ particles} \right) \left( \frac{750 \text{ torr}}{6 \times 10^6 \text{ particles}} \right) = \mathbf{500 \text{ torr}}$$

- 5.87 Plan: Write the balanced equation for the combustion of  $n$ -hexane. For part a), assuming a 1.00 L sample of air at STP, use the molar ratio in the balanced equation to find the volume of  $n$ -hexane required to react with the oxygen in 1.00 L of air. Convert the volume  $n$ -hexane to volume % and divide by 2 to obtain the LFL. For part b), use the LFL calculated in part a) to find the volume of  $n$ -hexane required to produce a flammable mixture and then use the ideal gas law to find moles of  $n$ -hexane. Convert moles of  $n$ -hexane to mass and then to volume using the density.

Solution:

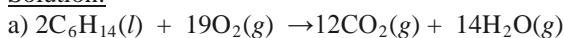

For a 1.00 L sample of air at STP:

$$\text{Volume of } \text{C}_6\text{H}_{14} \text{ vapor needed} = (1.00 \text{ L air}) \left( \frac{20.9 \text{ L } \text{O}_2}{100 \text{ L air}} \right) \left( \frac{2 \text{ L } \text{C}_6\text{H}_{14}}{19 \text{ L } \text{O}_2} \right) = 0.0220 \text{ L } \text{C}_6\text{H}_{14}$$

$$\text{Volume \% of C}_6\text{H}_{14} = \frac{\text{C}_6\text{H}_{14} \text{ volume}}{\text{air volume}}(100) = \frac{0.0220 \text{ L C}_6\text{H}_{14}}{1.00 \text{ L air}}(100) = 2.2\% \text{ C}_6\text{H}_{14}$$

$$\text{LFL} = 0.5(2.2\%) = \mathbf{1.1\% \text{ C}_6\text{H}_{14}}$$

$$\text{b) Volume of C}_6\text{H}_{14} \text{ vapor} = (1.000 \text{ m}^3 \text{ air}) \left( \frac{1 \text{ L}}{10^{-3} \text{ m}^3} \right) \left( \frac{1.1\% \text{ C}_6\text{H}_{14}}{100\% \text{ air}} \right) = 11.0 \text{ L C}_6\text{H}_{14}$$

$$V = 11.0 \text{ L}$$

$$P = 1 \text{ atm}$$

$$PV = nRT$$

Solving for  $n$ :

$$\text{Moles of C}_6\text{H}_{14} = n = \frac{PV}{RT} = \frac{(1 \text{ atm})(11.0 \text{ L})}{\left(0.0821 \frac{\text{L}\cdot\text{atm}}{\text{mol}\cdot\text{K}}\right)(273 \text{ K})} = 0.490780 \text{ mol C}_6\text{H}_{14}$$

$$\text{Volume of C}_6\text{H}_{14} \text{ liquid} = (0.490780 \text{ mol C}_6\text{H}_{14}) \left( \frac{86.17 \text{ g C}_6\text{H}_{14}}{1 \text{ mol C}_6\text{H}_{14}} \right) \left( \frac{1 \text{ mL}}{0.660 \text{ g C}_6\text{H}_{14}} \right) = 64.0765 = \mathbf{64 \text{ mL}}$$

**C<sub>6</sub>H<sub>14</sub>**

5.88 Plan: To find the factor by which a diver's lungs would expand, find the factor by which  $P$  changes from 125 ft to the surface, and apply Boyle's law. To find that factor, calculate  $P_{\text{seawater}}$  at 125 ft by converting the given depth from ft-seawater to mmHg to atm and adding the surface pressure (1.00 atm).

Solution:

$$P(\text{H}_2\text{O}) = (125 \text{ ft}) \left( \frac{12 \text{ in}}{1 \text{ ft}} \right) \left( \frac{2.54 \text{ cm}}{1 \text{ in}} \right) \left( \frac{10^{-2} \text{ m}}{1 \text{ cm}} \right) \left( \frac{1 \text{ mm}}{10^{-3} \text{ m}} \right) = 3.81 \times 10^4 \text{ mmH}_2\text{O}$$

$$P(\text{Hg}): \frac{h_{\text{H}_2\text{O}}}{h_{\text{Hg}}} = \frac{d_{\text{Hg}}}{d_{\text{H}_2\text{O}}} \quad \frac{3.81 \times 10^4 \text{ mmH}_2\text{O}}{h_{\text{Hg}}} = \frac{13.5 \text{ g/mL}}{1.04 \text{ g/mL}} \quad h_{\text{Hg}} = 2935.1111 \text{ mmHg}$$

$$P(\text{Hg}) = (2935.1111 \text{ mmHg}) \left( \frac{1 \text{ atm}}{760 \text{ mmHg}} \right) = 3.861988 \text{ atm}$$

$$P_{\text{total}} = (1.00 \text{ atm}) + (3.861988 \text{ atm}) = 4.861988 \text{ atm}$$

Use Boyle's law to find the volume change of the diver's lungs:

$$P_1 V_1 = P_2 V_2$$

$$\frac{V_2}{V_1} = \frac{P_1}{P_2} \quad \frac{V_2}{V_1} = \frac{4.861988 \text{ atm}}{1 \text{ atm}} = \mathbf{4.86}$$

To find the depth to which the diver could ascend safely, use the given safe expansion factor (1.5) and the pressure at 125 ft,  $P_{125}$ , to find the safest ascended pressure,  $P_{\text{safe}}$ .

$$P_{125}/P_{\text{safe}} = 1.5$$

$$P_{\text{safe}} = P_{125}/1.5 = (4.861988 \text{ atm})/1.5 = 3.241325 \text{ atm}$$

Convert the pressure in atm to pressure in ft of seawater using the conversion factors above. Subtract this distance from the initial depth to find how far the diver could ascend.

$$h(\text{Hg}): (4.861988 - 3.241325 \text{ atm}) \left( \frac{760 \text{ mmHg}}{1 \text{ atm}} \right) = 1231.7039 \text{ mmHg}$$

$$\frac{h_{\text{H}_2\text{O}}}{h_{\text{Hg}}} = \frac{d_{\text{Hg}}}{d_{\text{H}_2\text{O}}} \quad \frac{h_{\text{H}_2\text{O}}}{1231.7039 \text{ mmHg}} = \frac{13.5 \text{ g/mL}}{1.04 \text{ g/mL}} \quad h_{\text{H}_2\text{O}} = 15988.464 \text{ mm}$$

$$h_{\text{H}_2\text{O}}(\text{ft}) = (15988.464 \text{ mmH}_2\text{O}) \left( \frac{10^{-3} \text{ m}}{1 \text{ mm}} \right) \left( \frac{1.094 \text{ yd}}{1 \text{ m}} \right) \left( \frac{3 \text{ ft}}{1 \text{ yd}} \right) = 52.4741 \text{ ft}$$

Therefore, the diver can safely ascend 52.5 ft to a depth of  $(125 - 52.4741) = 72.5259 = \mathbf{73 \text{ ft}}$ .

- 5.89 Plan: The moles of gas may be found using the ideal gas law. Multiply moles of gas by Avogadro's number to obtain the number of molecules.

Solution:

$$V = 1 \text{ mL} = 0.001 \text{ L}$$

$$T = 500 \text{ K}$$

$$P = 10^{-8} \text{ mmHg}$$

$$n = \text{unknown}$$

$$\text{Converting } P \text{ from mmHg to atm: } P = (10^{-8} \text{ mmHg}) \left( \frac{1 \text{ atm}}{760 \text{ mmHg}} \right) = 1.315789 \times 10^{-11} \text{ atm}$$

$$PV = nRT$$

Solving for  $n$ :

$$\text{Moles of gas} = n = \frac{PV}{RT} = \frac{(1.315789 \times 10^{-11} \text{ atm})(0.001 \text{ L})}{\left(0.0821 \frac{\text{L}\cdot\text{atm}}{\text{mol}\cdot\text{K}}\right)(500 \text{ K})} = 3.2053337 \times 10^{-16} \text{ mol gas}$$

$$\text{Molecules} = (3.2053337 \times 10^{-16} \text{ mol}) \left( \frac{6.022 \times 10^{23} \text{ molecules}}{1 \text{ mol}} \right) = 1.93025 \times 10^8 = \mathbf{10^8 \text{ molecules}}$$

(The  $10^{-8}$  mmHg limits the significant figures.)

- 5.90 Plan: Use the equation for root mean speed ( $u_{\text{rms}}$ ) to find this value for  $\text{O}_2$  at  $0^\circ\text{C}$ . Molar mass values must be in units of kg/mol and temperature in kelvins. Divide the root mean speed by the mean free path to obtain the collision frequency.

Solution:

$$\text{a) } 0^\circ\text{C} = 273 \text{ K} \quad \mathcal{M} \text{ of } \text{O}_2 = \left( \frac{32.00 \text{ g O}_2}{\text{mol}} \right) \left( \frac{1 \text{ kg}}{10^3 \text{ g}} \right) = 0.03200 \text{ kg/mol}$$

$$R = 8.314 \text{ J/mol}\cdot\text{K} \quad 1 \text{ J} = \text{kg}\cdot\text{m}^2/\text{s}^2$$

$$u_{\text{rms}} = \sqrt{\frac{3RT}{\mathcal{M}}}$$

$$u_{\text{rms}} = \sqrt{\frac{3 \left( 8.314 \frac{\text{J}}{\text{mol}\cdot\text{K}} \right) (273 \text{ K})}{0.03200 \text{ kg/mol}} \left( \frac{\text{kg}\cdot\text{m}^2/\text{s}^2}{\text{J}} \right)} = 461.2878 = \mathbf{461 \text{ m/s}}$$

$$\text{b) Collision frequency} = \frac{u_{\text{rms}}}{\text{mean free path}} = \frac{461.2878 \text{ m/s}}{6.33 \times 10^{-8} \text{ m}} = 7.2873 \times 10^9 = \mathbf{7.29 \times 10^9 \text{ s}^{-1}}$$

- 5.91 Plan: Use the ideal gas law to calculate the molar volume, the volume of exactly one mole of gas, at the temperature and pressure given in the problem.

Solution:

$$V = \text{unknown}$$

$$T = 730. \text{ K}$$

$$P = 90 \text{ atm}$$

$$n = 1.00 \text{ mol}$$

$$PV = nRT$$

Solving for  $V$ :

$$V = \frac{nRT}{P} = \frac{(1.00 \text{ mol}) \left( 0.0821 \frac{\text{L}\cdot\text{atm}}{\text{mol}\cdot\text{K}} \right) (730. \text{ K})}{(90 \text{ atm})} = 0.66592 = \mathbf{0.67 \text{ L/mol}}$$

- 5.92 Plan: Use the ideal gas law to determine the total moles of gas produced. The total moles multiplied by the fraction of each gas gives the moles of that gas which may be converted to metric tons.

Solution:

$$V = 1.5 \times 10^3 \text{ m}^3$$

$$T = 298 \text{ K}$$

$$P = 1 \text{ atm}$$

$$n = \text{unknown}$$

$$\text{Converting } V \text{ from m}^3 \text{ to L: } V = (1.5 \times 10^3 \text{ m}^3) \left( \frac{1 \text{ L}}{10^{-3} \text{ m}^3} \right) = 1.5 \times 10^6 \text{ L}$$

$$PV = nRT$$

Solving for  $n$ :

$$\text{Moles of gas/day} = n = \frac{PV}{RT} = \frac{(1 \text{ atm})(1.5 \times 10^6 \text{ L})}{\left(0.0821 \frac{\text{L} \cdot \text{atm}}{\text{mol} \cdot \text{K}}\right)(298 \text{ K})} = 6.13101 \times 10^5 \text{ mol/day}$$

$$\text{Moles of gas/yr} = \left( \frac{6.13101 \times 10^5 \text{ mol}}{\text{day}} \right) \left( \frac{365.25 \text{ day}}{1 \text{ yr}} \right) = 2.23935 \times 10^7 \text{ mol/yr}$$

$$\text{Mass CO}_2 = (0.4896) \left( \frac{2.23935 \times 10^7 \text{ mol}}{\text{yr}} \right) \left( \frac{44.01 \text{ g CO}_2}{1 \text{ mol CO}_2} \right) \left( \frac{1 \text{ kg}}{10^3 \text{ g}} \right) \left( \frac{1 \text{ t}}{10^3 \text{ kg}} \right) = 482.519 = \mathbf{4.83 \times 10^2 \text{ t CO}_2/\text{yr}}$$

$$\text{Mass CO} = (0.0146) \left( \frac{2.23935 \times 10^7 \text{ mol}}{\text{yr}} \right) \left( \frac{28.01 \text{ g CO}}{1 \text{ mol CO}} \right) \left( \frac{1 \text{ kg}}{10^3 \text{ g}} \right) \left( \frac{1 \text{ t}}{10^3 \text{ kg}} \right) = 9.15773 = \mathbf{9.16 \text{ t CO/yr}}$$

$$\text{Mass H}_2\text{O} = (0.3710) \left( \frac{2.23935 \times 10^7 \text{ mol}}{\text{yr}} \right) \left( \frac{18.02 \text{ g H}_2\text{O}}{1 \text{ mol H}_2\text{O}} \right) \left( \frac{1 \text{ kg}}{10^3 \text{ g}} \right) \left( \frac{1 \text{ t}}{10^3 \text{ kg}} \right) = 149.70995 = \mathbf{1.50 \times 10^2 \text{ t H}_2\text{O/yr}}$$

$$\text{Mass SO}_2 = (0.1185) \left( \frac{2.23935 \times 10^7 \text{ mol}}{\text{yr}} \right) \left( \frac{64.07 \text{ g SO}_2}{1 \text{ mol SO}_2} \right) \left( \frac{1 \text{ kg}}{10^3 \text{ g}} \right) \left( \frac{1 \text{ t}}{10^3 \text{ kg}} \right) = 170.018 = \mathbf{1.70 \times 10^2 \text{ t SO}_2/\text{yr}}$$

$$\text{Mass S}_2 = (0.0003) \left( \frac{2.23935 \times 10^7 \text{ mol}}{\text{yr}} \right) \left( \frac{64.14 \text{ g S}_2}{1 \text{ mol S}_2} \right) \left( \frac{1 \text{ kg}}{10^3 \text{ g}} \right) \left( \frac{1 \text{ t}}{10^3 \text{ kg}} \right) = 0.4308957 = \mathbf{4 \times 10^{-1} \text{ t S}_2/\text{yr}}$$

$$\text{Mass H}_2 = (0.0047) \left( \frac{2.23935 \times 10^7 \text{ mol}}{\text{yr}} \right) \left( \frac{2.016 \text{ g H}_2}{1 \text{ mol H}_2} \right) \left( \frac{1 \text{ kg}}{10^3 \text{ g}} \right) \left( \frac{1 \text{ t}}{10^3 \text{ kg}} \right) = 0.21218 = \mathbf{2.1 \times 10^{-1} \text{ t H}_2/\text{yr}}$$

$$\text{Mass HCl} = (0.0008) \left( \frac{2.23935 \times 10^7 \text{ mol}}{\text{yr}} \right) \left( \frac{36.46 \text{ g HCl}}{1 \text{ mol HCl}} \right) \left( \frac{1 \text{ kg}}{10^3 \text{ g}} \right) \left( \frac{1 \text{ t}}{10^3 \text{ kg}} \right) = 0.6531736 = \mathbf{6 \times 10^{-1} \text{ t HCl/yr}}$$

$$\text{Mass H}_2\text{S} = (0.0003) \left( \frac{2.23935 \times 10^7 \text{ mol}}{\text{yr}} \right) \left( \frac{34.09 \text{ g H}_2\text{S}}{1 \text{ mol H}_2\text{S}} \right) \left( \frac{1 \text{ kg}}{10^3 \text{ g}} \right) \left( \frac{1 \text{ t}}{10^3 \text{ kg}} \right) = 0.229018 = \mathbf{2 \times 10^{-1} \text{ t H}_2\text{S/yr}}$$

- 5.93 Plan: Use the molar ratio from the balanced equation to find the moles of H<sub>2</sub> and O<sub>2</sub> required to form 28.0 moles of water. Then use the ideal gas law in part a) and van der Waals equation in part b) to find the pressure needed to provide that number of moles of each gas.

Solution:

a) The balanced chemical equation is:  $2\text{H}_2(\text{g}) + \text{O}_2(\text{g}) \rightarrow 2\text{H}_2\text{O}(\text{l})$

$$\text{Moles H}_2 = (28.0 \text{ mol H}_2\text{O}) \left( \frac{2 \text{ mol H}_2}{2 \text{ mol H}_2\text{O}} \right) = 28.0 \text{ mol H}_2$$

$$\text{Moles O}_2 = (28.0 \text{ mol H}_2\text{O}) \left( \frac{1 \text{ mol O}_2}{2 \text{ mol H}_2\text{O}} \right) = 14.0 \text{ mol O}_2$$

$$V = 20.0 \text{ L}$$

$$T = 23.8^\circ\text{C} + 273.2 = 297 \text{ K}$$

$$P = \text{unknown}$$

$$n = 28.0 \text{ mol H}_2; 14.0 \text{ mol O}_2$$

$$PV = nRT$$

Solving for  $P$ :

$$P_{\text{IGL of H}_2} = \frac{nRT}{V} = \frac{(28.0 \text{ mol}) \left( 0.0821 \frac{\text{L}\cdot\text{atm}}{\text{mol}\cdot\text{K}} \right) (297 \text{ K})}{20.0 \text{ L}} = 34.137 = \mathbf{34.1 \text{ atm H}_2}$$

$$P_{\text{IGL of O}_2} = \frac{nRT}{V} = \frac{(14.0 \text{ mol}) \left( 0.0821 \frac{\text{L}\cdot\text{atm}}{\text{mol}\cdot\text{K}} \right) (297 \text{ K})}{20.0 \text{ L}} = 17.06859 = \mathbf{17.1 \text{ atm O}_2}$$

b)  $V = 20.0 \text{ L}$

$$T = 23.8^\circ\text{C} + 273.2 = 297 \text{ K}$$

$P = \text{unknown}$

$$n = 28.0 \text{ mol H}_2; 14.0 \text{ mol O}_2$$

Van der Waals constants from Table 5.4:

$$\text{H}_2: a = 0.244 \frac{\text{atm}\cdot\text{L}^2}{\text{mol}^2}; \quad b = 0.0266 \frac{\text{L}}{\text{mol}}$$

$$\text{O}_2: a = 1.36 \frac{\text{atm}\cdot\text{L}^2}{\text{mol}^2}; \quad b = 0.0318 \frac{\text{L}}{\text{mol}}$$

$$\left( P + \frac{n^2 a}{V^2} \right) (V - nb) = nRT$$

$$P_{\text{VDW}} = \frac{nRT}{V - nb} - \frac{n^2 a}{V^2}$$

$$P_{\text{VDW of H}_2} = \frac{(28.0 \text{ mol}) \left( 0.0821 \frac{\text{L}\cdot\text{atm}}{\text{mol}\cdot\text{K}} \right) (297 \text{ K})}{20.0 \text{ L} - 28.0 \text{ mol} (0.0266 \text{ L/mol})} - \frac{(28.0 \text{ mol})^2 \left( 0.244 \frac{\text{atm}\cdot\text{L}^2}{\text{mol}^2} \right)}{(20.0 \text{ L})^2} = 34.9631 = \mathbf{35.0 \text{ atm H}_2}$$

$$P_{\text{VDW of O}_2} = \frac{(14.0 \text{ mol}) \left( 0.0821 \frac{\text{L}\cdot\text{atm}}{\text{mol}\cdot\text{K}} \right) (297 \text{ K})}{20.0 \text{ L} - 28.0 \text{ mol} (0.0318 \text{ L/mol})} - \frac{(14.0 \text{ mol})^2 \left( 1.36 \frac{\text{atm}\cdot\text{L}^2}{\text{mol}^2} \right)}{(20.0 \text{ L})^2} = 16.78228 = \mathbf{16.8 \text{ atm O}_2}$$

c) The van der Waals value for hydrogen is slightly higher than the value from the ideal gas law. The van der Waals value for oxygen is slightly lower than the value from the ideal gas law.

- 5.94 Plan: Use the molarity and volume of the solution to find the moles of HBr needed to make the solution. Then use the ideal gas law to find the volume of that number of moles of HBr gas at the given conditions.

Solution:

$$\text{Moles of HBr in the hydrobromic acid: } \left( \frac{1.20 \text{ mol HBr}}{\text{L}} \right) (3.50 \text{ L}) = 4.20 \text{ mol HBr}$$

$V = \text{unknown}$

$$T = 29^\circ\text{C} + 273 = 302 \text{ K}$$

$P = 0.965 \text{ atm}$

$$n = 4.20 \text{ mol}$$

$PV = nRT$

Solving for  $V$ :

$$V = \frac{nRT}{P} = \frac{(4.20 \text{ mol}) \left( 0.0821 \frac{\text{L}\cdot\text{atm}}{\text{mol}\cdot\text{K}} \right) (302 \text{ K})}{(0.965 \text{ atm})} = 107.9126 = \mathbf{108 \text{ L HBr}}$$

- 5.95 Plan:  $V$  and  $T$  are not given, so the ideal gas law cannot be used. The total pressure of the mixture is given. Use  $P_A = X_A \times P_{\text{total}}$  to find the mole fraction of each gas and then the mass fraction. The total mass of the two gases is 35.0 g.

Solution:

$$P_{\text{total}} = P_{\text{krypton}} + P_{\text{carbon dioxide}} = 0.708 \text{ atm}$$

The NaOH absorbed the  $\text{CO}_2$  leaving the Kr, thus  $P_{\text{krypton}} = 0.250 \text{ atm}$ .

$$P_{\text{carbon dioxide}} = P_{\text{total}} - P_{\text{krypton}} = 0.708 \text{ atm} - 0.250 \text{ atm} = 0.458 \text{ atm}$$

Determining mole fractions:  $P_A = X_A \times P_{\text{total}}$



$$\text{Carbon dioxide: } X = \frac{P_{\text{CO}_2}}{P_{\text{total}}} = \frac{0.458 \text{ atm}}{0.708 \text{ atm}} = 0.64689$$

$$\text{Krypton: } X = \frac{P_{\text{Kr}}}{P_{\text{total}}} = \frac{0.250 \text{ atm}}{0.708 \text{ atm}} = 0.353107$$

$$\text{Relative mass fraction} = \frac{\left[ (0.353107) \left( \frac{83.80 \text{ g Kr}}{\text{mol}} \right) \right]}{\left[ (0.64689) \left( \frac{44.01 \text{ g CO}_2}{\text{mol}} \right) \right]} = 1.039366$$

$$35.0 \text{ g} = x \text{ g CO}_2 + (1.039366 x) \text{ g Kr}$$

$$35.0 \text{ g} = 2.039366 x$$

$$\text{Grams CO}_2 = x = (35.0 \text{ g}) / (2.039366) = 17.16219581 = \mathbf{17.2 \text{ g CO}_2}$$

$$\text{Grams Kr} = 35.0 \text{ g} - 17.162 \text{ g CO}_2 = 17.83780419 = \mathbf{17.8 \text{ g Kr}}$$

- 5.96 Plan: Write the balanced equations. Use the ideal gas law to find the moles of SO<sub>2</sub> gas and then use the molar ratio between SO<sub>2</sub> and NaOH to find moles and then molarity of the NaOH solution.

Solution:

The balanced chemical equations are:

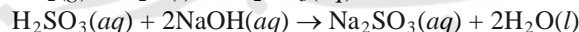
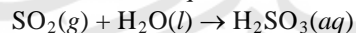

Combining these equations gives:



$$V = 0.200 \text{ L}$$

$$T = 19^\circ\text{C} + 273 = 292 \text{ K}$$

$$P = 745 \text{ mmHg}$$

$$n = \text{unknown}$$

$$\text{Converting } P \text{ from mmHg to atm: } P = (745 \text{ mmHg}) \left( \frac{1 \text{ atm}}{760 \text{ mmHg}} \right) = 0.980263 \text{ atm}$$

$$PV = nRT$$

Solving for  $n$ :

$$\text{Moles of SO}_2 = n = \frac{PV}{RT} = \frac{(0.980263 \text{ atm})(0.200 \text{ L})}{\left( 0.0821 \frac{\text{L}\cdot\text{atm}}{\text{mol}\cdot\text{K}} \right) (292 \text{ K})} = 8.17799 \times 10^{-3} \text{ mol SO}_2$$

$$\text{Moles of NaOH} = \left( 8.17799 \times 10^{-3} \text{ mol SO}_2 \right) \left( \frac{2 \text{ mol NaOH}}{1 \text{ mol SO}_2} \right) = 0.01635598 \text{ mol NaOH}$$

$$M \text{ NaOH} = \frac{\text{mol NaOH}}{\text{volume of NaOH}} = \frac{0.01635598 \text{ mol NaOH}}{10.0 \text{ mL}} \left( \frac{1 \text{ mL}}{10^{-3} \text{ L}} \right) = 1.635598 = \mathbf{1.64 \text{ M NaOH}}$$

- 5.97 Plan: Use the ideal gas law to find the number of moles of CO<sub>2</sub> and H<sub>2</sub>O in part a). The molar mass is then used to convert moles to mass. Temperature must be in units of kelvins, pressure in atm, and volume in L. For part b), use the molar ratio in the balanced equation to find the moles and then mass of C<sub>6</sub>H<sub>12</sub>O<sub>6</sub> that produces the number of moles of CO<sub>2</sub> exhaled during 8 h.

Solution:

$$\text{a) } V = 300 \text{ L}$$

$$T = 37.0^\circ\text{C} + 273.2 = 310.2 \text{ K}$$

$$P = 30.0 \text{ torr}$$

$$n = \text{unknown}$$

$$\text{Converting } P \text{ from torr to atm: } P = (30.0 \text{ torr}) \left( \frac{1 \text{ atm}}{760 \text{ torr}} \right) = 0.0394737 \text{ atm}$$

$$PV = nRT$$

Solving for  $n$ :

$$\text{Moles of CO}_2 = \text{moles of H}_2\text{O} = n = \frac{PV}{RT} = \frac{(0.0394737 \text{ atm})(300 \text{ L})}{\left(0.0821 \frac{\text{L}\cdot\text{atm}}{\text{mol}\cdot\text{K}}\right)(310.2 \text{ K})} = 0.464991 \text{ mol}$$



$$\text{Mass (g) of CO}_2 = (0.464991 \text{ mol CO}_2) \left( \frac{44.01 \text{ g CO}_2}{1 \text{ mol CO}_2} \right) = 20.4643 = \mathbf{20.5 \text{ g CO}_2}$$

$$\text{Mass (g) of H}_2\text{O} = (0.464991 \text{ mol H}_2\text{O}) \left( \frac{18.02 \text{ g H}_2\text{O}}{1 \text{ mol H}_2\text{O}} \right) = 8.3791 = \mathbf{8.38 \text{ g H}_2\text{O}}$$

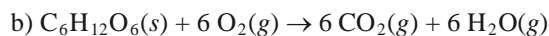

$$\text{Moles of CO}_2 \text{ exhaled in 8 h} = \left( \frac{0.464991 \text{ mol CO}_2}{\text{h}} \right) (8 \text{ h}) = 3.719928 \text{ mol CO}_2$$

$$\begin{aligned} \text{Mass (g) of C}_6\text{H}_{12}\text{O}_6 &= (3.719928 \text{ mol CO}_2) \left( \frac{1 \text{ mol C}_6\text{H}_{12}\text{O}_6}{6 \text{ mol CO}_2} \right) \left( \frac{180.16 \text{ g C}_6\text{H}_{12}\text{O}_6}{1 \text{ mol C}_6\text{H}_{12}\text{O}_6} \right) \\ &= 111.6970 = 1 \times 10^2 \text{ g C}_6\text{H}_{12}\text{O}_6 \text{ (= body mass lost)} \end{aligned}$$

(This assumes the significant figures are limited by the 8 h.)

5.98 a) Derive  $u_{\text{rms}} = \sqrt{\frac{3RT}{\mathcal{M}}}$

Set the given relationships equal to each other.

$$\frac{1}{2} m \overline{u^2} = \frac{3}{2} \left( \frac{R}{N_A} \right) T \quad \text{Multiply each side by 2 and divide by } m.$$

$$\overline{u^2} = \frac{3}{m} \left( \frac{R}{N_A} \right) T$$

$$\overline{u^2} = \frac{3RT}{mN_A}$$

Solve for  $u$  by taking the square root of each side; substitute molar mass,  $\mathcal{M}$ , for  $mN_A$  (mass of one molecule x Avogadro's number of molecules).

$$u_{\text{rms}} = \sqrt{\frac{3RT}{\mathcal{M}}}$$

b) Derive Graham's Law  $\frac{\sqrt{\mathcal{M}_1}}{\sqrt{\mathcal{M}_2}} = \frac{\text{rate}_2}{\text{rate}_1}$

At a given  $T$ , the average kinetic energy is equal for two substances, with molecular masses  $m_1$  and  $m_2$ :

$$\overline{E_k} = \frac{1}{2} m_1 \overline{u_1^2} = \frac{1}{2} m_2 \overline{u_2^2}$$

$$m_1 \overline{u_1^2} = m_2 \overline{u_2^2}$$

$$\frac{m_1}{m_2} = \frac{\overline{u_2^2}}{\overline{u_1^2}} \rightarrow \frac{\sqrt{m_1}}{\sqrt{m_2}} = \frac{\overline{u_2}}{\overline{u_1}}$$

The average molecular speed,  $u$ , is directly proportional to the rate of effusion. Therefore, substitute "rate" for each " $u$ ." In addition, the molecular mass is directly proportional to the molar mass, so substitute  $\mathcal{M}$  for each  $m$ :

$$\frac{\sqrt{\mathcal{M}_1}}{\sqrt{\mathcal{M}_2}} = \frac{\text{rate}_2}{\text{rate}_1}$$

5.99 Plan: Use the ideal gas law to find the moles of gas occupying the tank at 85% of the 85.0 atm ranking. Then use van der Waals equation to find the pressure of this number of moles of gas.

**Solution:**

a)  $V = 850. \text{ L}$

$T = 298 \text{ K}$

$$P = (85.0 \text{ atm}) \left( \frac{80\%}{100\%} \right) = 68.0 \text{ atm} \quad n = \text{unknown}$$

$$PV = nRT$$

Solving for  $n$ :

$$\text{Moles of Cl}_2 = n = \frac{PV}{RT} = \frac{(68.0 \text{ atm})(850. \text{ L})}{\left(0.0821 \frac{\text{L}\cdot\text{atm}}{\text{mol}\cdot\text{K}}\right)(298 \text{ K})} = 2.36248 \times 10^3 = \mathbf{2.36 \times 10^3 \text{ mol Cl}_2}$$

b)  $V = 850. \text{ L}$

$T = 298 \text{ K}$

$P = \text{unknown}$

$n = 2.36248 \times 10^3 \text{ mol Cl}_2$

Van der Waals constants from Table 5.4:

$$a = 6.49 \frac{\text{atm}\cdot\text{L}^2}{\text{mol}^2}; \quad b = 0.0562 \frac{\text{L}}{\text{mol}}$$

$$\left( P + \frac{n^2 a}{V^2} \right) (V - nb) = nRT$$

$$P_{\text{VDW}} = \frac{nRT}{V - nb} - \frac{n^2 a}{V^2}$$

$$P_{\text{VDW}} = \frac{(2.36248 \times 10^3 \text{ mol Cl}_2) \left(0.08206 \frac{\text{L}\cdot\text{atm}}{\text{mol}\cdot\text{K}}\right) (298 \text{ K})}{850. \text{ L} - (2.36248 \times 10^3 \text{ mol Cl}_2) \left(0.0562 \frac{\text{L}}{\text{mol}}\right)} - \frac{(2.36248 \times 10^3 \text{ mol Cl}_2)^2 \left(6.49 \frac{\text{atm}\cdot\text{L}^2}{\text{mol}^2}\right)}{(850. \text{ L})^2}$$

$$= 30.4134 = \mathbf{30.4 \text{ atm}}$$

c) The engineer did not completely fill the tank. She should have filled it to  $(80.0\%/100\%)(85.0 \text{ atm}) = 68 \text{ atm}$ , but only filled it to 30.4 atm.

5.100 **Plan:** Use the relationship  $\frac{P_1 V_1}{n_1 T_1} = \frac{P_2 V_2}{n_2 T_2}$  or  $V_2 = \frac{P_1 V_1 n_2 T_2}{P_2 n_1 T_1}$ .  $R$  is fixed.

**Solution:**

a) As the pressure on a fixed amount of gas ( $n$  is fixed) increases at constant temperature ( $T$  is fixed), the molecules move closer together, decreasing the volume. When the pressure is increased by a factor of 2, the volume decreases by a factor of 2 at constant temperature (Boyle's law).

$$V_2 = \frac{P_1 V_1 T_2}{P_2 T_1} = \frac{(P_1)(V_1)(1)}{(2P_1)(1)} \quad V_2 = \frac{1}{2} V_1$$

**Cylinder B** has half the volume of the original cylinder.

b) The temperature is decreased by a factor of 2, so the volume is decreased by a factor of 2 (Charles's law).

$$V_2 = \frac{P_1 V_1 T_2}{P_2 T_1} = \frac{(1)(V_1)(200 \text{ K})}{(1)(400 \text{ K})} \quad V_2 = \frac{1}{2} V_1$$

**Cylinder B** has half the volume of the original cylinder.

c)  $T_1 = 100^\circ\text{C} + 273 = 373 \text{ K}$

$T_2 = 200^\circ\text{C} + 273 = 473 \text{ K}$

The temperature increases by a factor of  $473/373 = 1.27$ , so the volume is increased by a factor of 1.27 (Charles's law).

$$V_2 = \frac{P_1 V_1 T_2}{P_2 T_1} = \frac{(1)(V_1)(473 \text{ K})}{(1)(373 \text{ K})} \quad V_2 = 1.27 V_1$$

**None** of the cylinders show a volume increase of 1.27.

d) As the number of molecules of gas increases at constant pressure and temperature ( $P$  and  $T$  are fixed), the force they exert on the container increases. This results in an increase in the volume of the container. Adding 0.1 mole

of gas to 0.1 mole increases the number of moles by a factor of 2, thus the volume increases by a factor of 2 (Avogadro's law).

$$V_2 = \frac{P_1 V_1 n_2 T_2}{P_2 n_1 T_1} = \frac{(1)(V_1)(0.2)(1)}{(1)(0.1)(1)} \quad V_2 = 2V_1$$

**Cylinder C** has a volume that is twice as great as the original cylinder.

e) Adding 0.1 mole of gas to 0.1 mole increases the number of moles by a factor of 2, thus increasing the volume by a factor of 2. Increasing the pressure by a factor of 2 results in the volume decreasing by a factor of 1/2. The two volume changes cancel out so that the volume does not change.

$$V_2 = \frac{P_1 V_1 n_2 T_2}{P_2 n_1 T_1} = \frac{(P_1)(V_1)(0.2)(1)}{(2P_1)(0.1)(1)} \quad V_2 = V_1$$

**Cylinder D** has the same volume as the original cylinder.

- 5.101 **Plan:** Since the mole fractions of the three gases must add to 1, the mole fraction of methane is found by subtracting the sum of the mole fractions of helium and argon from 1.  $P_{\text{methane}} = X_{\text{methane}} P_{\text{total}}$  is used to calculate the pressure of methane and then the ideal gas law is used to find moles of gas. Avogadro's number is needed to convert moles of methane to molecules of methane.

**Solution:**

$$X_{\text{methane}} = 1.00 - (X_{\text{argon}} + X_{\text{helium}}) = 1.00 - (0.35 + 0.25) = 0.40$$

$$P_{\text{methane}} = X_{\text{methane}} P_{\text{total}} = (0.40)(1.75 \text{ atm}) = 0.70 \text{ atm CH}_4$$

$$V = 6.0 \text{ L} \quad T = 45^\circ\text{C} + 273 = 318 \text{ K}$$

$$P = 0.70 \text{ atm} \quad n = \text{unknown}$$

$$PV = nRT$$

Solving for  $n$ :

$$\text{Moles of CH}_4 = n = \frac{PV}{RT} = \frac{(0.70 \text{ atm})(6.0 \text{ L})}{\left(0.0821 \frac{\text{L}\cdot\text{atm}}{\text{mol}\cdot\text{K}}\right)(318 \text{ K})} = 0.1608715 \text{ mol}$$

$$\begin{aligned} \text{Molecules of CH}_4 &= (0.1608715 \text{ mol CH}_4) \left( \frac{6.022 \times 10^{23} \text{ CH}_4 \text{ molecules}}{1 \text{ mol CH}_4} \right) \\ &= 9.68768 \times 10^{22} = \mathbf{9.7 \times 10^{22} \text{ molecules CH}_4} \end{aligned}$$

- 5.102 **Plan:** For part a), convert mass of glucose to moles and use the molar ratio from the balanced equation to find the moles of CO<sub>2</sub> gas produced. Use the ideal gas law to find the volume of that amount of CO<sub>2</sub>. Pressure must be in units of atm and temperature in kelvins. For part b), use the molar ratios in the balanced equation to calculate the moles of each gas and then use Dalton's law of partial pressures to determine the pressure of each gas.

**Solution:**

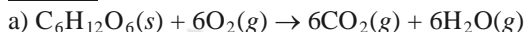

$$\text{Moles CO}_2: (20.0 \text{ g C}_6\text{H}_{12}\text{O}_6) \left( \frac{1 \text{ mol C}_6\text{H}_{12}\text{O}_6}{180.16 \text{ g C}_6\text{H}_{12}\text{O}_6} \right) \left( \frac{6 \text{ mol CO}_2}{1 \text{ mol C}_6\text{H}_{12}\text{O}_6} \right) = 0.666075 \text{ mol CO}_2$$

Finding the volume of CO<sub>2</sub>:

$$V = \text{unknown}$$

$$T = 37^\circ\text{C} + 273 = 310 \text{ K}$$

$$P = 780. \text{ torr}$$

$$n = 0.666075 \text{ mol}$$

$$\text{Converting } P \text{ from torr to atm: } P = (780. \text{ torr}) \left( \frac{1 \text{ atm}}{760 \text{ torr}} \right) = 1.0263158 \text{ atm}$$

$$PV = nRT$$

Solving for  $V$ :

$$V = \frac{nRT}{P} = \frac{(0.666075 \text{ mol}) \left( 0.0821 \frac{\text{L}\cdot\text{atm}}{\text{mol}\cdot\text{K}} \right) (310 \text{ K})}{(1.0263158 \text{ atm})} = 16.5176 = \mathbf{16.5 \text{ L CO}_2}$$

This solution assumes that partial pressure of O<sub>2</sub> does not interfere with the reaction conditions.

$$\begin{aligned} \text{b) Moles CO}_2 = \text{moles O}_2 &= (10.0 \text{ g C}_6\text{H}_{12}\text{O}_6) \left( \frac{1 \text{ mol C}_6\text{H}_{12}\text{O}_6}{180.16 \text{ g C}_6\text{H}_{12}\text{O}_6} \right) \left( \frac{6 \text{ mol}}{1 \text{ mol C}_6\text{H}_{12}\text{O}_6} \right) \\ &= 0.333037 \text{ mol CO}_2 = \text{mol O}_2 \end{aligned}$$

At 37°C, the vapor pressure of water is 48.8 torr. No matter how much water is produced, the partial pressure of H<sub>2</sub>O will still be 48.8 torr. The remaining pressure, 780 torr – 48.8 torr = 731.2 torr is the sum of partial pressures for O<sub>2</sub> and CO<sub>2</sub>. Since the mole fractions of O<sub>2</sub> and CO<sub>2</sub> are equal, their pressures must be equal, and must be one-half of 731.2 torr.

**$P_{\text{water}} = 48.8 \text{ torr}$**

$(731.2 \text{ torr})/2 = 365.6 = \mathbf{3.7 \times 10^2 \text{ torr}}$   $P_{\text{oxygen}} = P_{\text{carbon dioxide}}$

- 5.103 **Plan:** Use the relationship between mole fraction and partial pressure,  $P_A = X_A P_{\text{total}}$ , to find the mole fraction of each gas in parts a) and b). For parts c) and d), use the ideal gas law to find the moles of air in 1000 L of air at these conditions and compare the moles of each gas to the moles of air. Mass and molecules must be converted to moles.

**Solution:**

a) Assuming the total pressure is 1 atm = 760 torr.

$$P_A = X_A P_{\text{total}}$$

$$X_{\text{Br}_2} = \frac{P_{\text{Br}_2}}{P_{\text{total}}} = \frac{0.2 \text{ torr}}{760 \text{ torr}} = 2.6315789 \times 10^{-4} \times (10^6) = 263.15789 = 300 \text{ ppmv } \mathbf{Unsafe}$$

$$\text{b) } X_{\text{CO}_2} = \frac{P_{\text{CO}_2}}{P_{\text{total}}} = \frac{0.2 \text{ torr}}{760 \text{ torr}} = 2.6315789 \times 10^{-4} \times (10^6) = 263.15789 = 300 \text{ ppmv } \mathbf{Safe}$$

$$(0.2 \text{ torr CO}_2/760 \text{ torr})(10^6) = 263.15789 = 300 \text{ ppmv CO}_2 \mathbf{Safe}$$

$$\text{c) Moles Br}_2 = (0.0004 \text{ g Br}_2) \left( \frac{1 \text{ mol Br}_2}{159.80 \text{ g Br}_2} \right) = 2.5031 \times 10^{-6} \text{ mol Br}_2 \text{ (unrounded)}$$

Finding the moles of air:

$$V = 1000 \text{ L}$$

$$P = 1.00 \text{ atm}$$

$$PV = nRT$$

$$T = 0^\circ\text{C} + 273 = 273 \text{ K}$$

$$n = \text{unknown}$$

$$\text{Moles of air } = n = \frac{PV}{RT} = \frac{(1.00 \text{ atm})(1000 \text{ L})}{\left(0.0821 \frac{\text{L}\cdot\text{atm}}{\text{mol}\cdot\text{K}}\right)(273 \text{ K})} = 44.616 \text{ mol air (unrounded)}$$

$$\begin{aligned} \text{Concentration of Br}_2 &= \text{mol Br}_2/\text{mol air}(10^6) = [(2.5031 \times 10^{-6} \text{ mol})/(44.616 \text{ mol})] (10^6) \\ &= 0.056103 = 0.06 \text{ ppmv Br}_2 \mathbf{Safe} \end{aligned}$$

$$\text{d) Moles CO}_2 = (2.8 \times 10^{22} \text{ molecules CO}_2) \left( \frac{1 \text{ mol CO}_2}{6.022 \times 10^{23} \text{ molecules CO}_2} \right) = 0.046496 \text{ mol CO}_2$$

$$\begin{aligned} \text{Concentration of CO}_2 &= \text{mol CO}_2/\text{mol air}(10^6) = [(0.046496 \text{ mol})/(44.616 \text{ mol})] (10^6) = 1042.1 \\ &= 1.0 \times 10^3 \text{ ppmv CO}_2 \mathbf{Safe} \end{aligned}$$

- 5.104 **Plan:** For part a), use the ideal gas law to find the moles of NO in the flue gas. The moles of NO are converted to moles of NH<sub>3</sub> using the molar ratio in the balanced equation and the moles of NH<sub>3</sub> are converted to volume using the ideal gas law. For part b), the moles of NO in 1 kL of flue gas is found using the ideal gas law; the molar ratio in the balanced equation is used to convert moles of NO to moles and then mass of NH<sub>3</sub>.

**Solution:**

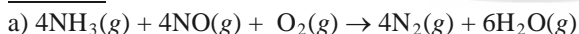

Finding the moles of NO in 1.00 L of flue gas:

$$V = 1.00 \text{ L}$$

$$P = 4.5 \times 10^{-5} \text{ atm}$$

$$PV = nRT$$

$$T = 365^\circ\text{C} + 273 = 638 \text{ K}$$

$$n = \text{unknown}$$

Solving for  $n$ :

$$\text{Moles of NO} = n = \frac{PV}{RT} = \frac{(4.5 \times 10^{-5} \text{ atm})(1.00 \text{ L})}{\left(0.0821 \frac{\text{L} \cdot \text{atm}}{\text{mol} \cdot \text{K}}\right)(638 \text{ K})} = 8.5911 \times 10^{-7} \text{ mol NO}$$

$$\text{Moles of NH}_3 = \left(8.5911 \times 10^{-7} \text{ mol NO}\right) \left(\frac{4 \text{ mol NH}_3}{4 \text{ mol NO}}\right) = 8.5911 \times 10^{-7} \text{ mol NH}_3$$

Volume of NH<sub>3</sub>:

V = unknown

$$T = 365^\circ\text{C} + 273 = 638 \text{ K}$$

P = 1.00 atm

$$n = 8.5911 \times 10^{-7} \text{ mol}$$

PV = nRT

Solving for V:

$$V = \frac{nRT}{P} = \frac{(8.5911 \times 10^{-7} \text{ mol}) \left(0.0821 \frac{\text{L} \cdot \text{atm}}{\text{mol} \cdot \text{K}}\right) (638 \text{ K})}{(1.00 \text{ atm})} = 4.5000 \times 10^{-5} = \mathbf{4.5 \times 10^{-5} \text{ L NH}_3}$$

b) Finding the moles of NO in 1.00 kL of flue gas:

V = 1.00 kL = 1000 L

$$T = 365^\circ\text{C} + 273 = 638 \text{ K}$$

P = 4.5 × 10<sup>-5</sup> atm

n = unknown

PV = nRT

Solving for n:

$$\text{Moles of NO} = n = \frac{PV}{RT} = \frac{(4.5 \times 10^{-5} \text{ atm})(1000 \text{ L})}{\left(0.0821 \frac{\text{L} \cdot \text{atm}}{\text{mol} \cdot \text{K}}\right) (638 \text{ K})} = 8.5911 \times 10^{-4} \text{ mol NO}$$

$$\text{Moles of NH}_3 = \left(8.5911 \times 10^{-4} \text{ mol NO}\right) \left(\frac{4 \text{ mol NH}_3}{4 \text{ mol NO}}\right) = 8.5911 \times 10^{-4} \text{ mol NH}_3$$

$$\text{Mass of NH}_3 = \left(8.59 \times 10^{-4} \text{ mol NH}_3\right) \left(\frac{1 \text{ mol NH}_3}{17.03 \text{ g NH}_3}\right) = 0.014631 = \mathbf{0.015 \text{ g NH}_3}$$

5.105 Plan: Use Graham's law to compare effusion rates.

Solution:

$$\frac{\text{Rate Ne}}{\text{Rate Xe}} = \sqrt{\frac{\text{molar mass Xe}}{\text{molar mass Ne}}} = \sqrt{\frac{131.3 \text{ g/mol}}{20.18 \text{ g/mol}}} = \frac{2.55077}{1} \text{ enrichment factor (unrounded)}$$

$$\text{Thus } X_{\text{Ne}} = \frac{\text{moles of Ne}}{\text{moles of Ne} + \text{moles of Xe}} = \frac{2.55077 \text{ mol}}{2.55077 \text{ mol} + 1 \text{ mol}} = 0.71837 = \mathbf{0.7184}$$

5.106 Plan: To find the number of steps through the membrane, calculate the molar masses to find the ratio of effusion rates. This ratio is the enrichment factor for each step.

Solution:

$$\begin{aligned} \frac{\text{Rate}_{235 \text{ UF}_6}}{\text{Rate}_{238 \text{ UF}_6}} &= \sqrt{\frac{\text{molar mass } ^{238} \text{ UF}_6}{\text{molar mass } ^{235} \text{ UF}_6}} = \sqrt{\frac{352.04 \text{ g/mol}}{349.03 \text{ g/mol}}} \\ &= 1.004302694 \text{ enrichment factor} \end{aligned}$$

Therefore, the abundance of <sup>235</sup>UF<sub>6</sub> after one membrane is 0.72% × 1.004302694

Abundance of <sup>235</sup>UF<sub>6</sub> after "N" membranes = 0.72% × (1.004302694)<sup>N</sup>

Desired abundance of <sup>235</sup>UF<sub>6</sub> = 3.0% = 0.72% × (1.004302694)<sup>N</sup>

Solving for N:

$$3.0\% = 0.72\% \times (1.004302694)^N$$

$$4.16667 = (1.004302694)^N$$

$$\ln 4.16667 = \ln (1.004302694)^N$$

$$\ln 4.16667 = N \times \ln (1.004302694)$$

$$N = (\ln 4.16667)/(\ln 1.004302694)$$

$$N = 1.4271164/0.004293464 = 332.39277 = \mathbf{332 \text{ steps}}$$

- 5.107 Plan: The amount of each gas that leaks from the balloon is proportional to its effusion rate. Using 35% as the rate for H<sub>2</sub>, the rate for O<sub>2</sub> can be determined from Graham's law.

Solution:

$$\frac{\text{Rate O}_2}{\text{Rate H}_2} = \sqrt{\frac{\text{molar mass H}_2}{\text{molar mass O}_2}} = \sqrt{\frac{2.016 \text{ g/mol}}{32.00 \text{ g/mol}}} = \frac{\text{rate O}_2}{35}$$

$$0.250998008 = \frac{\text{rate O}_2}{35}$$

$$\text{Rate O}_2 = 8.78493$$

Amount of H<sub>2</sub> that leaks = 35%; 100–35 = 65% H<sub>2</sub> remains

Amount of O<sub>2</sub> that leaks = 8.78493%; 100–8.78493 = 91.21507% O<sub>2</sub> remains

$$\frac{\text{O}_2}{\text{H}_2} = \frac{91.21507}{65} = 1.40331 = \mathbf{1.4}$$

- 5.108 Plan: For part a), put together the various combinations of the two isotopes of Cl with P and add the masses. Multiply the abundances of the isotopes in each combination to find the most abundant for part b). For part c), use Graham's law to find the effusion rates.

Solution:

a) Options for PCl<sub>3</sub>:

All values are g/mol

P	First Cl	Second Cl	Third Cl	Total
31	35	35	35	136
31	37	35	35	138
31	37	37	35	140
31	37	37	37	142

b) The fraction abundances are <sup>35</sup>Cl = 75%/100% = 0.75, and <sup>37</sup>Cl = 25%/100% = 0.25.

The relative amount of each mass comes from the product of the relative abundances of each Cl isotope.

$$\text{Mass 136} = (0.75)(0.75)(0.75) = \mathbf{0.421875} = \mathbf{0.42 \text{ (most abundant)}}$$

$$\text{Mass 138} = (0.25)(0.75)(0.75) = 0.140625 = 0.14$$

$$\text{Mass 140} = (0.25)(0.25)(0.75) = 0.046875 = 0.047$$

$$\text{Mass 142} = (0.25)(0.25)(0.25) = 0.015625 = 0.016$$

$$\text{c) } \frac{\text{Rate P}^{37}\text{Cl}_3}{\text{Rate P}^{35}\text{Cl}_3} = \sqrt{\frac{\text{molar mass P}^{35}\text{Cl}_3}{\text{molar mass P}^{37}\text{Cl}_3}} = \sqrt{\frac{136 \text{ g/mol}}{142 \text{ g/mol}}}$$

$$= 0.978645 = \mathbf{0.979}$$



# CHAPTER 6 THERMOCHEMISTRY: ENERGY FLOW AND CHEMICAL CHANGE

## END-OF-CHAPTER PROBLEMS

6.1 **No**, an increase in temperature means that heat has been transferred to the surroundings, which makes  $q$  negative.

6.2  $\Delta E = q + w = w$ , since  $q = 0$ .  
Thus, the change in work equals the change in internal energy.

6.3 a) electric heater      b) sound amplifier      c) light bulb      d) automobile alternator  
e) battery (voltaic cell)

6.4 Heat energy; sound energy (impact)  
↓  
Kinetic energy (falling text)  
↓  
Potential energy (raised text)  
↓  
Mechanical energy (raising of text)  
↓  
Chemical energy (biological process to move muscles)

6.5 **Plan:** The change in a system's energy is  $\Delta E = q + w$ . If the system receives heat, then its  $q_{\text{final}}$  is greater than  $q_{\text{initial}}$  so  $q$  is positive. Since the system performs work, its  $w_{\text{final}} < w_{\text{initial}}$  so  $w$  is negative.

**Solution:**

$$\Delta E = q + w$$

$$\Delta E = (+425 \text{ J}) + (-425 \text{ J}) = \mathbf{0 \text{ J}}$$

6.6  $q + w = -255 \text{ cal} + (-428 \text{ cal}) = \mathbf{-683 \text{ cal}}$

6.7 **Plan:** Convert  $6.6 \times 10^{10} \text{ J}$  to the other units using conversion factors.

**Solution:**

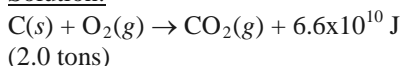

$$\text{a) } \Delta E (\text{kJ}) = (6.6 \times 10^{10} \text{ J}) \left( \frac{1 \text{ kJ}}{10^3 \text{ J}} \right) = \mathbf{6.6 \times 10^7 \text{ kJ}}$$

$$\text{b) } \Delta E (\text{kcal}) = (6.6 \times 10^{10} \text{ J}) \left( \frac{1 \text{ cal}}{4.184 \text{ J}} \right) \left( \frac{1 \text{ kcal}}{10^3 \text{ cal}} \right) = 1.577 \times 10^7 = \mathbf{1.6 \times 10^7 \text{ kcal}}$$

$$\text{c) } \Delta E (\text{Btu}) = (6.6 \times 10^{10} \text{ J}) \left( \frac{1 \text{ Btu}}{1055 \text{ J}} \right) = 6.256 \times 10^7 = \mathbf{6.3 \times 10^7 \text{ Btu}}$$

6.8  $\text{CaCO}_3(s) + 9.0 \times 10^6 \text{ kJ} \rightarrow \text{CaO}(s) + \text{CO}_2(g)$   
(5.0 tons)

$$\text{a) } \Delta E (\text{J}) = (9.0 \times 10^6 \text{ kJ}) \left( \frac{10^3 \text{ J}}{1 \text{ kJ}} \right) = \mathbf{9.0 \times 10^9 \text{ J}}$$

$$b) \Delta E (\text{cal}) = (9.0 \times 10^6 \text{ kJ}) \left( \frac{10^3 \text{ J}}{1 \text{ kJ}} \right) \left( \frac{1 \text{ cal}}{4.184 \text{ J}} \right) = 2.15105 \times 10^9 = \mathbf{2.2 \times 10^9 \text{ cal}}$$

$$c) \Delta E (\text{Btu}) = (9.0 \times 10^6 \text{ kJ}) \left( \frac{10^3 \text{ J}}{1 \text{ kJ}} \right) \left( \frac{1 \text{ Btu}}{1055 \text{ J}} \right) = 8.5308 \times 10^6 = \mathbf{8.5 \times 10^6 \text{ Btu}}$$

$$6.9 \quad \Delta E (\text{J}) = (4.1 \times 10^3 \text{ Calorie}) \left( \frac{10^3 \text{ cal}}{1 \text{ Calorie}} \right) \left( \frac{4.184 \text{ J}}{1 \text{ cal}} \right) = 1.7154 \times 10^7 = \mathbf{1.7 \times 10^7 \text{ J}}$$

$$\Delta E (\text{kJ}) = (4.1 \times 10^3 \text{ Calorie}) \left( \frac{10^3 \text{ cal}}{1 \text{ Calorie}} \right) \left( \frac{4.184 \text{ J}}{1 \text{ cal}} \right) \left( \frac{1 \text{ kJ}}{10^3 \text{ J}} \right) = 1.7154 \times 10^4 = \mathbf{1.7 \times 10^4 \text{ kJ}}$$

6.10 Plan: An exothermic process releases heat and an endothermic process absorbs heat.

Solution:

a) **Exothermic**, the system (water) is releasing heat in changing from liquid to solid.

b) **Endothermic**, the system (water) is absorbing heat in changing from liquid to gas.

c) **Exothermic**, the process of digestion breaks down food and releases energy.

d) **Exothermic**, heat is released as a person runs and muscles perform work.

e) **Endothermic**, heat is absorbed as food calories are converted to body tissue.

f) **Endothermic**, the wood being chopped absorbs heat (and work).

g) **Exothermic**, the furnace releases heat from fuel combustion. Alternatively, if the system is defined as the air in the house, the change is endothermic since the air's temperature is increasing by the input of heat energy from the furnace.

6.11 Absolute enthalpy values, like absolute energy values, are unknown.

6.12 Plan: An exothermic reaction releases heat, so the reactants have greater  $H$  ( $H_{\text{initial}}$ ) than the products ( $H_{\text{final}}$ ).

$$\Delta H = H_{\text{final}} - H_{\text{initial}} < 0.$$

Solution:

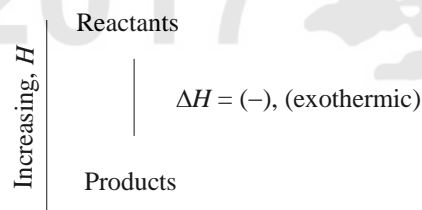

6.13

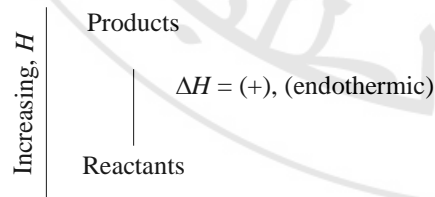

6.14 Plan: Combustion of hydrocarbons and related compounds require oxygen (and a heat catalyst) to yield carbon dioxide gas, water vapor, and heat. Combustion reactions are exothermic. The freezing of liquid water is an exothermic process as heat is removed from the water in the conversion from liquid to solid. An exothermic reaction or process releases heat, so the reactants have greater  $H$  ( $H_{\text{initial}}$ ) than the products ( $H_{\text{final}}$ ).

**Solution:**

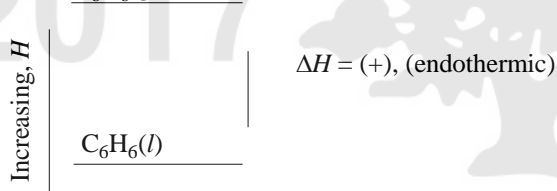
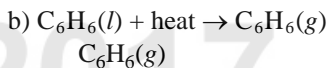
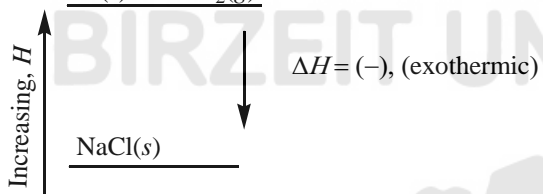
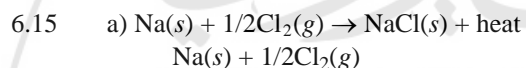
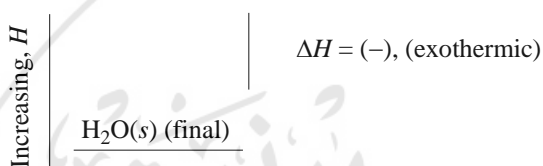
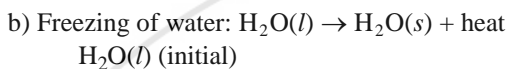
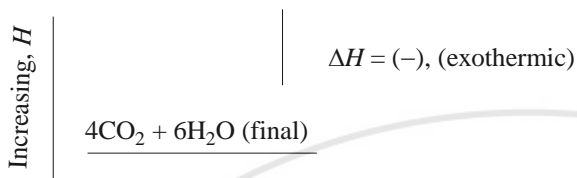
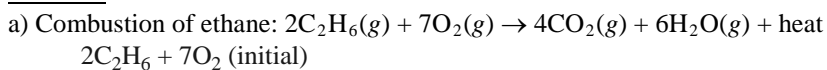

6.16 **Plan:** Combustion of hydrocarbons and related compounds require oxygen (and a heat catalyst) to yield carbon dioxide gas, water vapor, and heat. Combustion reactions are exothermic. An exothermic reaction releases heat, so the reactants have greater  $H$  ( $H_{\text{initial}}$ ) than the products ( $H_{\text{final}}$ ). If heat is absorbed, the reaction is endothermic and the products have greater  $H$  ( $H_{\text{final}}$ ) than the reactants ( $H_{\text{initial}}$ ).

**Solution:**

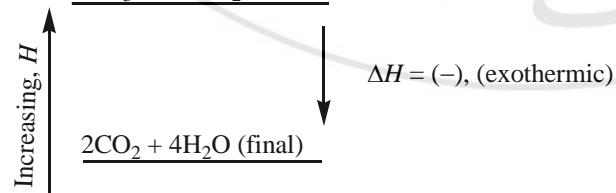
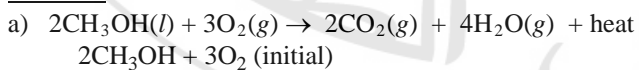

b) Nitrogen dioxide,  $\text{NO}_2$ , forms from  $\text{N}_2$  and  $\text{O}_2$ .

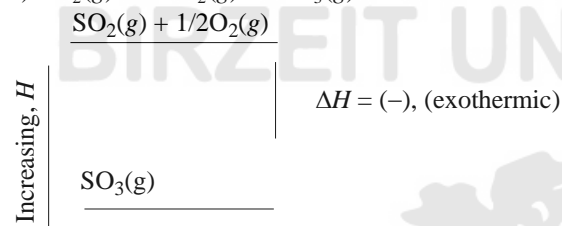
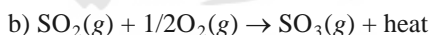
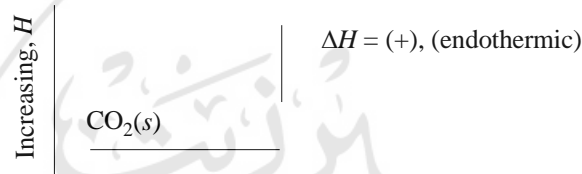
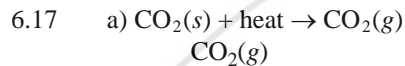
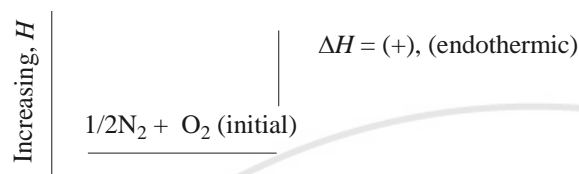
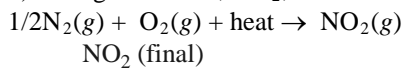

6.18 **Plan:** Recall that  $q_{\text{sys}}$  is positive if heat is absorbed by the system (endothermic) and negative if heat is released by the system (exothermic). Since  $\Delta E = q + w$ , the work must be considered in addition to  $q_{\text{sys}}$  to find  $\Delta E_{\text{sys}}$ .

**Solution:**

a) This is a phase change from the solid phase to the gas phase. Heat is absorbed by the system so  $q_{\text{sys}}$  is **positive (+)**.

b) The system is expanding in volume as more moles of gas exist after the phase change than were present before the phase change. So the system has done work of expansion and  $w$  is negative.  $\Delta E_{\text{sys}} = q + w$ . Since  $q$  is positive and  $w$  is negative, the sign of  $\Delta E_{\text{sys}}$  **cannot be predicted**. It will be positive if  $q > w$  and negative if  $q < w$ .

c)  $\Delta E_{\text{univ}} = 0$ . If the system loses energy, the surroundings gain an equal amount of energy. The sum of the energy of the system and the energy of the surroundings remains constant.

6.19 a) There is a volume decrease;  $V_{\text{final}} < V_{\text{initial}}$  so  $\Delta V$  is negative. Since  $w_{\text{sys}} = -P\Delta V$ ,  $w$  is **positive, +**.

b)  $\Delta H_{\text{sys}}$  is – as heat has been removed from the system to liquefy the gas.

c)  $\Delta E_{\text{sys}} = q + w$ . Since  $q$  is negative and  $w$  is positive, the sign of  $\Delta E_{\text{sys}}$  and  $\Delta E_{\text{surr}}$  cannot be predicted.  $\Delta E_{\text{sys}}$  will be positive and  $\Delta E_{\text{surr}}$  will be negative if  $w > q$  and  $\Delta E_{\text{sys}}$  will be negative and  $\Delta E_{\text{surr}}$  will be positive if  $w < q$ .

6.20 To determine the specific heat capacity of a substance, you need its mass, the heat added (or lost), and the change in temperature.

6.21 Specific heat capacity is an **intensive property**; it is defined on a per gram basis. The specific heat capacity of a particular substance has the same value, regardless of the amount of substance present.

- 6.22 Plan: The heat required to raise the temperature of water is found by using the equation  $q = c \times \text{mass} \times \Delta T$ . The specific heat capacity,  $c_{\text{water}}$ , is found in Table 6.2. Because the Celsius degree is the same size as the Kelvin degree,  $\Delta T = 100^\circ\text{C} - 25^\circ\text{C} = 75^\circ\text{C} = 75\text{ K}$ .

Solution:

$$q (\text{J}) = c \times \text{mass} \times \Delta T = \left(4.184 \frac{\text{J}}{\text{g}\cdot\text{K}}\right)(22.0 \text{ g})(75 \text{ K}) = 6903.6 = \mathbf{6.9 \times 10^3 \text{ J}}$$

6.23  $q (\text{J}) = c \times \text{mass} \times \Delta T = \left(2.087 \frac{\text{J}}{\text{g}\cdot\text{K}}\right)(0.10 \text{ g})((-75 - 10.)\text{K}) = -17.7395 = \mathbf{-18 \text{ J}}$

- 6.24 Plan: Use the relationship  $q = c \times \text{mass} \times \Delta T$ . We know the heat (change kJ to J), the specific heat capacity, and the mass, so  $\Delta T$  can be calculated. Once  $\Delta T$  is known, that value is added to the initial temperature to find the final temperature.

Solution:

$$q (\text{J}) = c \times \text{mass} \times \Delta T \quad T_{\text{initial}} = 13.00^\circ\text{C} \quad T_{\text{final}} = ? \quad \text{mass} = 295 \text{ g} \quad c = 0.900 \text{ J/g}\cdot\text{K}$$

$$q = (75.0 \text{ kJ}) \left(\frac{10^3 \text{ J}}{1 \text{ kJ}}\right) = 7.50 \times 10^4 \text{ J}$$

$$7.50 \times 10^4 \text{ J} = (0.900 \text{ J/g}\cdot\text{K})(295 \text{ g})(\Delta T)$$

$$\Delta T = \frac{(7.50 \times 10^4 \text{ J})}{(295 \text{ g}) \left(\frac{0.900 \text{ J}}{\text{g}\cdot\text{K}}\right)}$$

$$\Delta T = 282.4859 \text{ K} = 282.4859^\circ\text{C} \quad (\text{Because the Celsius degree is the same size as the Kelvin degree, } \Delta T \text{ is the same in either temperature unit.)}$$

$$\Delta T = T_{\text{final}} - T_{\text{initial}}$$

$$T_{\text{final}} = \Delta T + T_{\text{initial}}$$

$$T_{\text{final}} = 282.4859^\circ\text{C} + 13.00^\circ\text{C} = 295.49 = \mathbf{295^\circ\text{C}}$$

6.25  $q (\text{J}) = c \times \text{mass} \times \Delta T$   
 $-688 \text{ J} = (2.42 \text{ J/g}\cdot\text{K})(27.7 \text{ g})(\Delta T)$   
 $(\Delta T) = \frac{(-688 \text{ J})}{(27.7 \text{ g}) \left(\frac{2.42 \text{ J}}{\text{g}\cdot\text{K}}\right)} = -10.26345 \text{ K} = \mathbf{-10.26345^\circ\text{C}}$

$$\Delta T = T_{\text{final}} - T_{\text{initial}}$$

$$T_{\text{initial}} = T_{\text{final}} - \Delta T$$

$$T_{\text{initial}} = 32.5^\circ\text{C} - (-10.26345^\circ\text{C}) = 42.76345 = \mathbf{42.8^\circ\text{C}}$$

- 6.26 Plan: Since the bolts have the same mass and same specific heat capacity, and one must cool as the other heats (the heat lost by the “hot” bolt equals the heat gained by the “cold” bolt), the final temperature is an average of the two initial temperatures.

Solution:

$$\left[\frac{(T_1 + T_2)}{2}\right] = \left[\frac{(100.^\circ\text{C} + 55^\circ\text{C})}{2}\right] = \mathbf{77.5^\circ\text{C}}$$

6.27  $-q_{\text{lost}} = q_{\text{gained}}$   
 $-2(\text{mass})(c_{\text{Cu}})(T_{\text{final}} - 105)^\circ\text{C} = (\text{mass})(c_{\text{Cu}})(T_{\text{final}} - 45)^\circ\text{C}$   
 $-2(T_{\text{final}} - 105)^\circ\text{C} = (T_{\text{final}} - 45)^\circ\text{C}$   
 $2(105^\circ\text{C}) - 2T_{\text{final}} = T_{\text{final}} - 45^\circ\text{C}$   
 $210^\circ\text{C} + 45^\circ\text{C} = T_{\text{final}} + 2T_{\text{final}} = 3T_{\text{final}}$   
 $(255^\circ\text{C})/3 = T_{\text{final}} = \mathbf{85.0^\circ\text{C}}$

- 6.28 Plan: The heat lost by the water originally at 85°C is gained by the water that is originally at 26°C. Therefore  $-q_{\text{lost}} = q_{\text{gained}}$ . Both volumes are converted to mass using the density.

Solution:

$$\text{Mass (g) of 75 mL} = (75 \text{ mL}) \left( \frac{1.00 \text{ g}}{1 \text{ mL}} \right) = 75 \text{ g} \qquad \text{Mass (g) of 155 mL} = (155 \text{ mL}) \left( \frac{1.00 \text{ g}}{1 \text{ mL}} \right) = 155 \text{ g}$$

$$-q_{\text{lost}} = q_{\text{gained}}$$

$$c \times \text{mass} \times \Delta T (85^\circ\text{C water}) = c \times \text{mass} \times \Delta T (26^\circ\text{C water})$$

$$-(4.184 \text{ J/g}^\circ\text{C})(75 \text{ g})(T_{\text{final}} - 85^\circ\text{C}) = (4.184 \text{ J/g}^\circ\text{C})(155 \text{ g})(T_{\text{final}} - 26^\circ\text{C})$$

$$-(75 \text{ g})(T_{\text{final}} - 85^\circ\text{C}) = (155 \text{ g})(T_{\text{final}} - 26^\circ\text{C})$$

$$6375 - 75T_{\text{final}} = 155T_{\text{final}} - 4030$$

$$6375 + 4030 = 155T_{\text{final}} + 75T_{\text{final}}$$

$$10405 = 230T_{\text{final}}$$

$$T_{\text{final}} = (10405/230.) = 45.24 = \mathbf{45^\circ\text{C}}$$

- 6.29  $-q_{\text{lost}} = q_{\text{gained}}$   
 $-[24.4 \text{ mL}(1.00 \text{ g/mL})](4.184 \text{ J/g}^\circ\text{C})(23.5 - 35.0)^\circ\text{C} = (\text{mass})(4.184 \text{ J/g}^\circ\text{C})(23.5 - 18.2)^\circ\text{C}$   
 $-(24.4)(23.5 - 35.0) = (\text{mass})(23.5 - 18.2)$   
 $-(24.4)(-11.5) = (\text{mass})(5.3)$   
 $280.6 = (\text{mass})(5.3)$   
 $52.943 \text{ g} = \text{mass}$

$$\text{Volume (mL)} = (52.943 \text{ g}) \left( \frac{1 \text{ mL}}{1.00 \text{ g}} \right) = 52.943 = \mathbf{53 \text{ mL}}$$

- 6.30 Benzoic acid is  $\text{C}_6\text{H}_5\text{COOH}$ , and will be symbolized as HBz.

$$-q_{\text{reaction}} = q_{\text{water}} + q_{\text{calorimeter}}$$

$$-q_{\text{reaction}} = -(1.221 \text{ g HBz}) \left( \frac{1 \text{ mol HBz}}{122.12 \text{ g HBz}} \right) \left( \frac{-3227 \text{ kJ}}{1 \text{ mol HBz}} \right) \left( \frac{10^3 \text{ J}}{1 \text{ kJ}} \right) = 3.226472 \times 10^4 \text{ J}$$

$$q_{\text{water}} = c \times \text{mass} \times \Delta T = 4.184 \text{ J/g}^\circ\text{C} \times 1200 \text{ g} \times \Delta T$$

$$q_{\text{calorimeter}} = C \times \Delta T = 1365 \text{ J/}^\circ\text{C} \times \Delta T$$

$$-q_{\text{reaction}} = q_{\text{water}} + q_{\text{calorimeter}}$$

$$3.226472 \times 10^4 \text{ J} = 4.184 \text{ J/g}^\circ\text{C} \times 1200 \text{ g} \times \Delta T + 1365 \text{ J/}^\circ\text{C} \times \Delta T$$

$$3.226472 \times 10^4 \text{ J} = 5020.8(\Delta T) + 1365(\Delta T)$$

$$3.226472 \times 10^4 \text{ J} = 6385.8(\Delta T)$$

$$\Delta T = 3.226472 \times 10^4 / 6385.8 = 5.052573 = \mathbf{5.053^\circ\text{C}}$$

- 6.31 a) Energy will flow from Cu (at 100.0°C) to Fe (at 0.0°C).  
 b) To determine the final temperature, the heat capacity of the calorimeter must be known.  
 c)  $-q_{\text{Cu}} = q_{\text{Fe}} + q_{\text{calorimeter}}$  assume  $q_{\text{calorimeter}} = 0$ .

$$-q_{\text{Cu}} = q_{\text{Fe}} + 0$$

$$-(20.0 \text{ g Cu})(0.387 \text{ J/g}^\circ\text{C})(T_{\text{final}} - 100.0)^\circ\text{C} = (30.0 \text{ g Fe})(0.450 \text{ J/g}^\circ\text{C})(T_{\text{final}} - 0.0)^\circ\text{C} + 0.0 \text{ J}$$

$$-(20.0 \text{ g})(0.387 \text{ J/g}^\circ\text{C})(T_{\text{final}} - 100.0^\circ\text{C}) = (30.0 \text{ g})(0.450 \text{ J/g}^\circ\text{C})(T_{\text{final}} - 0.0^\circ\text{C})$$

$$-(7.74)(T_{\text{final}} - 100.0) = (13.5)(T_{\text{final}} - 0.0)$$

$$774 - 7.74 T_{\text{final}} = 13.5 T_{\text{final}}$$

$$774 = (13.5 + 7.74) T_{\text{final}} = 21.24 T_{\text{final}}$$

$$T_{\text{final}} = 774/21.24 = 36.44068 = \mathbf{36.4^\circ\text{C}}$$

- 6.32 The reaction is:  $2\text{KOH}(aq) + \text{H}_2\text{SO}_4(aq) \rightarrow \text{K}_2\text{SO}_4(aq) + 2\text{H}_2\text{O}(l)$   
 $q \text{ (kJ)} = (25.0 + 25.0) \text{ mL}(1.00 \text{ g/mL})(4.184 \text{ J/g}^\circ\text{C})(30.17 - 23.50)^\circ\text{C}(1 \text{ kJ}/10^3 \text{ J}) = 1.395364 \text{ kJ}$   
 (The temperature increased so the heat of reaction is exothermic.)  
 Amount (moles) of  $\text{H}_2\text{SO}_4 = (25.0 \text{ mL})(0.500 \text{ mol H}_2\text{SO}_4/\text{L})(10^{-3} \text{ L}/1 \text{ mL}) = 0.0125 \text{ mol H}_2\text{SO}_4$   
 Amount (moles) of  $\text{KOH} = (25.0 \text{ mL})(1.00 \text{ mol KOH}/\text{L})(10^{-3} \text{ L}/1 \text{ mL}) = 0.0250 \text{ mol KOH}$   
 The moles show that both  $\text{H}_2\text{SO}_4$  and  $\text{KOH}$  are limiting.  
 The enthalpy change could be calculated in any of the following ways:

$$\Delta H = -1.395364 \text{ kJ}/0.0125 \text{ mol H}_2\text{SO}_4 = -111.62912 = \mathbf{-112 \text{ kJ/mol H}_2\text{SO}_4}$$

$$\Delta H = -1.395364 \text{ kJ}/0.0250 \text{ mol KOH} = -55.81456 = \mathbf{-55.8 \text{ kJ/mol KOH}}$$

(Per mole of  $\text{K}_2\text{SO}_4$  gives the same value as per mole of  $\text{H}_2\text{SO}_4$ , and per mole of  $\text{H}_2\text{O}$  gives the same value as per mole of  $\text{KOH}$ .)

- 6.33 Plan: Recall that  $\Delta H$  is positive for an endothermic reaction in which heat is absorbed, while  $\Delta H$  is negative for an exothermic reaction in which heat is released.

Solution:

The reaction has a **positive**  $\Delta H_{\text{rxn}}$ , because this reaction requires the input of energy to break the oxygen-oxygen bond in  $\text{O}_2$ :



- 6.34 Plan: Recall that  $\Delta H$  is positive for an endothermic reaction in which heat is absorbed, while  $\Delta H$  is negative for an exothermic reaction in which heat is released.

Solution:

As a substance changes from the gaseous state to the liquid state, energy is released so  $\Delta H$  would be negative for the condensation of 1 mol of water. The value of  $\Delta H$  for the vaporization of 2 mol of water would be twice the value of  $\Delta H$  for the condensation of 1 mol of water vapor but would have an opposite sign ( $+\Delta H$ ).

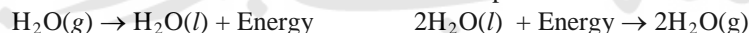

$$\Delta H_{\text{condensation}} = (-) \quad \Delta H_{\text{vaporization}} = (+)2[\Delta H_{\text{condensation}}]$$

The enthalpy for 1 mole of water condensing would be opposite in sign to and one-half the value for the conversion of 2 moles of liquid  $\text{H}_2\text{O}$  to  $\text{H}_2\text{O}$  vapor.

- 6.35 Plan: Recall that  $\Delta H$  is positive for an endothermic reaction in which heat is absorbed, while  $\Delta H$  is negative for an exothermic reaction in which heat is released. The  $\Delta H_{\text{rxn}}$  is specific for the reaction as written, meaning that 20.2 kJ is released when one-eighth of a mole of sulfur reacts. Use the ratio between moles of sulfur and  $\Delta H$  to convert between amount of sulfur and heat released.

Solution:

a) This reaction is **exothermic** because  $\Delta H$  is negative.

b) Because  $\Delta H$  is a state function, the total energy required for the reverse reaction, regardless of how the change occurs, is the same magnitude but different sign of the forward reaction. Therefore,  $\Delta H = \mathbf{+20.2 \text{ kJ}}$ .

$$\text{c) } \Delta H_{\text{rxn}} = (2.6 \text{ mol S}_8) \left( \frac{-20.2 \text{ kJ}}{(1/8) \text{ mol S}_8} \right) = -420.16 = \mathbf{-4.2 \times 10^2 \text{ kJ}}$$

d) The mass of  $\text{S}_8$  requires conversion to moles and then a calculation identical to part c) can be performed.

$$\Delta H_{\text{rxn}} = (25.0 \text{ g S}_8) \left( \frac{1 \text{ mol S}_8}{256.56 \text{ g S}_8} \right) \left( \frac{-20.2 \text{ kJ}}{(1/8) \text{ mol S}_8} \right) = -15.7468 = \mathbf{-15.7 \text{ kJ}}$$

- 6.36  $\text{MgCO}_3(\text{s}) \rightarrow \text{MgO}(\text{s}) + \text{CO}_2(\text{g}) \quad \Delta H_{\text{rxn}} = 117.3 \text{ kJ}$

a) **Absorbed**

$$\text{b) } \Delta H_{\text{rxn}} (\text{reverse}) = \mathbf{-117.3 \text{ kJ}}$$

$$\text{c) } \Delta H_{\text{rxn}} = (5.35 \text{ mol CO}_2) \left( \frac{-117.3 \text{ kJ}}{1 \text{ mol CO}_2} \right) = -627.555 = \mathbf{-628 \text{ kJ}}$$

$$\text{d) } \Delta H_{\text{rxn}} = (35.5 \text{ g CO}_2) \left( \frac{1 \text{ mol CO}_2}{44.01 \text{ g CO}_2} \right) \left( \frac{-117.3 \text{ kJ}}{1 \text{ mol CO}_2} \right) = -94.618 = \mathbf{-94.6 \text{ kJ}}$$

- 6.37 Plan: A thermochemical equation is a balanced equation that includes the heat of reaction. Since heat is absorbed in this reaction,  $\Delta H$  will be positive. Convert the mass of  $\text{NO}$  to moles and use the ratio between  $\text{NO}$  and  $\Delta H$  to find the heat involved for this amount of  $\text{NO}$ .

Solution:



b)  $\Delta H_{\text{rxn}} = (3.50 \text{ g NO}) \left( \frac{1 \text{ mol NO}}{30.01 \text{ g NO}} \right) \left( \frac{-90.29 \text{ kJ}}{1 \text{ mol NO}} \right) = -10.5303 = \mathbf{-10.5 \text{ kJ}}$

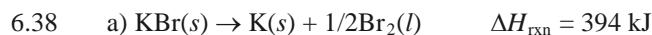

b)  $\Delta H_{\text{rxn}} = (10.0 \text{ kg KBr}) \left( \frac{10^3 \text{ g}}{1 \text{ kg}} \right) \left( \frac{1 \text{ mol KBr}}{119.00 \text{ g KBr}} \right) \left( \frac{-394 \text{ kJ}}{1 \text{ mol KBr}} \right) = -3.3109 \times 10^4 = \mathbf{-3.31 \times 10^4 \text{ kJ}}$

6.39 Plan: For the reaction written, 2 moles of  $\text{H}_2\text{O}_2$  release 196.1 kJ of energy upon decomposition. Use this ratio to convert between the given amount of reactant and the amount of heat released. The amount of  $\text{H}_2\text{O}_2$  must be converted from kg to g to moles.

Solution:



Heat (kJ) =  $q = (652 \text{ kg H}_2\text{O}_2) \left( \frac{10^3 \text{ g}}{1 \text{ kg}} \right) \left( \frac{1 \text{ mol H}_2\text{O}_2}{34.02 \text{ g H}_2\text{O}_2} \right) \left( \frac{-196.1 \text{ kJ}}{2 \text{ mol H}_2\text{O}_2} \right) = -1.87915 \times 10^6 = \mathbf{-1.88 \times 10^6 \text{ kJ}}$

6.40 For the reaction written, 1 mole of  $\text{B}_2\text{H}_6$  releases 755.4 kJ of energy upon reaction.

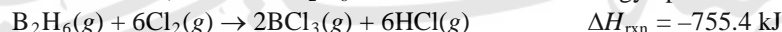

Heat (kJ) =  $q = (1 \text{ kg}) \left( \frac{10^3 \text{ g}}{1 \text{ kg}} \right) \left( \frac{1 \text{ mol B}_2\text{H}_6}{27.67 \text{ g B}_2\text{H}_6} \right) \left( \frac{-755.4 \text{ kJ}}{1 \text{ mol B}_2\text{H}_6} \right) = -2.73003 \times 10^4 = \mathbf{-2.730 \times 10^4 \text{ kJ/kg}}$

6.41 Plan: A thermochemical equation is a balanced equation that includes the heat of reaction. Heat is released in this reaction so  $\Delta H$  is negative. Use the ratio between  $\Delta H$  and moles of  $\text{C}_2\text{H}_4$  to find the amount of  $\text{C}_2\text{H}_4$  that must react to produce the given quantity of heat.

Solution:

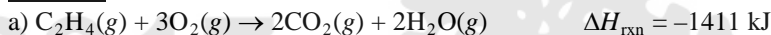

b) Mass (g) of  $\text{C}_2\text{H}_4 = (-70.0 \text{ kJ}) \left( \frac{1 \text{ mol C}_2\text{H}_4}{-1411 \text{ kJ}} \right) \left( \frac{28.05 \text{ g C}_2\text{H}_4}{1 \text{ mol C}_2\text{H}_4} \right) = 1.39157 = \mathbf{1.39 \text{ g C}_2\text{H}_4}$



b) Heat (kJ) =  $q = (1 \text{ g C}_{12}\text{H}_{22}\text{O}_{11}) \left( \frac{1 \text{ mol C}_{12}\text{H}_{22}\text{O}_{11}}{342.30 \text{ g C}_{12}\text{H}_{22}\text{O}_{11}} \right) \left( \frac{-5.64 \times 10^3 \text{ kJ}}{1 \text{ mol C}_{12}\text{H}_{22}\text{O}_{11}} \right) = -16.47677 = \mathbf{-16.5 \text{ kJ/g}}$

6.43 Hess's law:  $\Delta H_{\text{rxn}}$  is independent of the number of steps or the path of the reaction.

6.44 Plan: To obtain the overall reaction, add the first reaction to the reverse of the second. When the second reaction is reversed, the sign of its enthalpy change is reversed from positive to negative.

Solution:



6.46 Plan: Add the two equations, canceling substances that appear on both sides of the arrow. When matching the equations with the arrows in the Figure, remember that a positive  $\Delta H$  corresponds to an arrow pointing up while a negative  $\Delta H$  corresponds to an arrow pointing down.



**Solution:**

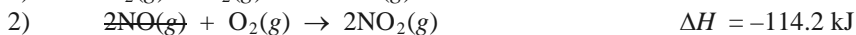
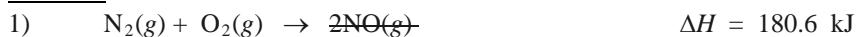

In Figure P6.46, **A** represents reaction 1 with a larger amount of energy absorbed, **B** represents reaction 2 with a smaller amount of energy released, and **C** represents reaction 3 as the sum of A and B.

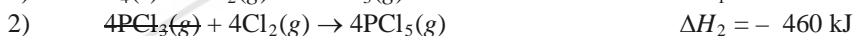
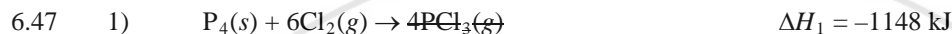

**Equation 1) = B, equation 2) = C, equation 3) = A**

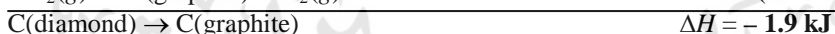

6.49 The standard heat of reaction,  $\Delta H_{\text{rxn}}^\circ$ , is the enthalpy change for any reaction where all substances are in their standard states. The standard heat of formation,  $\Delta H_f^\circ$ , is the enthalpy change that accompanies the formation of one mole of a compound in its standard state from elements in their standard states. Standard state is 1 atm for gases, 1 M for solutes, and the most stable form for liquids and solids. Standard state does not include a specific temperature, but a temperature must be specified in a table of standard values.

6.50 **Plan:**  $\Delta H_f^\circ$  is for the reaction that shows the formation of one mole of compound from its elements in their standard states.

**Solution:**

a)  $1/2\text{Cl}_2(\text{g}) + \text{Na}(\text{s}) \rightarrow \text{NaCl}(\text{s})$  The element chlorine occurs as  $\text{Cl}_2$ , not Cl.

b)  $\text{H}_2(\text{g}) + 1/2\text{O}_2(\text{g}) \rightarrow \text{H}_2\text{O}(\text{g})$  The element hydrogen exists as  $\text{H}_2$ , not H, and the formation of water is written with water as the product.

c) No changes

6.51 **Plan:** Formation equations show the formation of one mole of compound from its elements. The elements must be in their most stable states ( $\Delta H_f^\circ = 0$ ).

**Solution:**

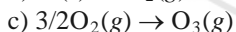
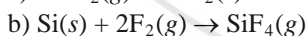
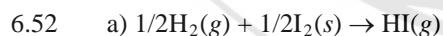
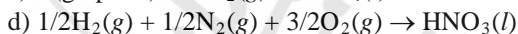
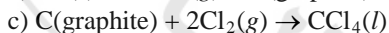

6.53 **Plan:** The enthalpy change of a reaction is the sum of the heats of formation of the products minus the sum of the heats of formation of the reactants. Since the  $\Delta H_f^\circ$  values (Appendix B) are reported as energy per one mole, use the appropriate stoichiometric coefficient to reflect the higher number of moles.

**Solution:**

$$\Delta H_{\text{rxn}}^{\circ} = \sum m \Delta H_{\text{f}}^{\circ}(\text{products}) - \sum n \Delta H_{\text{f}}^{\circ}(\text{reactants})$$

$$\begin{aligned} \text{a) } \Delta H_{\text{rxn}}^{\circ} &= \{2 \Delta H_{\text{f}}^{\circ} [\text{SO}_2(\text{g})] + 2 \Delta H_{\text{f}}^{\circ} [\text{H}_2\text{O}(\text{g})]\} - \{2 \Delta H_{\text{f}}^{\circ} [\text{H}_2\text{S}(\text{g})] + 3 \Delta H_{\text{f}}^{\circ} [\text{O}_2(\text{g})]\} \\ &= [(2 \text{ mol})(-296.8 \text{ kJ/mol}) + (2 \text{ mol})(-241.826 \text{ kJ/mol})] - [(2 \text{ mol})(-20.2 \text{ kJ/mol}) + (3 \text{ mol})(0.0 \text{ kJ/mol})] \\ &= \mathbf{-1036.9 \text{ kJ}} \end{aligned}$$

b) The balanced equation is  $\text{CH}_4(\text{g}) + 4\text{Cl}_2(\text{g}) \rightarrow \text{CCl}_4(\text{l}) + 4\text{HCl}(\text{g})$

$$\Delta H_{\text{rxn}}^{\circ} = \{1 \Delta H_{\text{f}}^{\circ} [\text{CCl}_4(\text{l})] + 4 \Delta H_{\text{f}}^{\circ} [\text{HCl}(\text{g})]\} - \{1 \Delta H_{\text{f}}^{\circ} [\text{CH}_4(\text{g})] + 4 \Delta H_{\text{f}}^{\circ} [\text{Cl}_2(\text{g})]\}$$

$$\begin{aligned} \Delta H_{\text{rxn}}^{\circ} &= [(1 \text{ mol})(-139 \text{ kJ/mol}) + (4 \text{ mol})(-92.31 \text{ kJ/mol})] - [(1 \text{ mol})(-74.87 \text{ kJ/mol}) + (4 \text{ mol})(0 \text{ kJ/mol})] \\ &= \mathbf{-433 \text{ kJ}} \end{aligned}$$

$$6.54 \quad \Delta H_{\text{rxn}}^{\circ} = \sum m \Delta H_{\text{f}}^{\circ}(\text{products}) - \sum n \Delta H_{\text{f}}^{\circ}(\text{reactants})$$

$$\begin{aligned} \text{a) } \Delta H_{\text{rxn}}^{\circ} &= \{1 \Delta H_{\text{f}}^{\circ} [\text{SiF}_4(\text{g})] + 2 \Delta H_{\text{f}}^{\circ} [\text{H}_2\text{O}(\text{l})]\} - \{1 \Delta H_{\text{f}}^{\circ} [\text{SiO}_2(\text{s})] + 4 \Delta H_{\text{f}}^{\circ} [\text{HF}(\text{g})]\} \\ &= [(1 \text{ mol})(-1614.9 \text{ kJ/mol}) + (2 \text{ mol})(-285.840 \text{ kJ/mol})] \\ &\quad - [(1 \text{ mol})(-910.9 \text{ kJ/mol}) + (4 \text{ mol})(-273 \text{ kJ/mol})] \\ &= \mathbf{-184 \text{ kJ}} \end{aligned}$$

b)  $2\text{C}_2\text{H}_6(\text{g}) + 7\text{O}_2(\text{g}) \rightarrow 4\text{CO}_2(\text{g}) + 6\text{H}_2\text{O}(\text{g})$

$$\Delta H_{\text{rxn}}^{\circ} = \{4 \Delta H_{\text{f}}^{\circ} [\text{CO}_2(\text{g})] + 6 \Delta H_{\text{f}}^{\circ} [\text{H}_2\text{O}(\text{g})]\} - \{2 \Delta H_{\text{f}}^{\circ} [\text{C}_2\text{H}_6(\text{g})] + 7 \Delta H_{\text{f}}^{\circ} [\text{O}_2(\text{g})]\}$$

$$\begin{aligned} &= [(4 \text{ mol})(-393.5 \text{ kJ/mol}) + (6 \text{ mol})(-241.826 \text{ kJ/mol})] - [(2 \text{ mol})(-84.667 \text{ kJ/mol}) + (7 \text{ mol})(0 \text{ kJ/mol})] \\ &= \mathbf{-2855.6 \text{ kJ}} \text{ (or } -1427.8 \text{ kJ for reaction of 1 mol of } \text{C}_2\text{H}_6\text{)} \end{aligned}$$

6.55 **Plan:** The enthalpy change of a reaction is the sum of the heats of formation of the products minus the sum of the heats of formation of the reactants. Since the  $\Delta H_{\text{f}}^{\circ}$  values (Appendix B) are reported as energy per one mole, use the appropriate stoichiometric coefficient to reflect the higher number of moles. In this case,  $\Delta H_{\text{rxn}}^{\circ}$  is known and

$\Delta H_{\text{f}}^{\circ}$  of CuO must be calculated.

**Solution:**

$$\Delta H_{\text{rxn}}^{\circ} = \sum m \Delta H_{\text{f}}^{\circ}(\text{products}) - \sum n \Delta H_{\text{f}}^{\circ}(\text{reactants})$$



$$\Delta H_{\text{rxn}}^{\circ} = \{2 \Delta H_{\text{f}}^{\circ} [\text{CuO}(\text{s})]\} - \{1 \Delta H_{\text{f}}^{\circ} [\text{Cu}_2\text{O}(\text{s})] + 1/2 \Delta H_{\text{f}}^{\circ} [\text{O}_2(\text{g})]\}$$

$$-146.0 \text{ kJ} = \{(2 \text{ mol}) \Delta H_{\text{f}}^{\circ} [\text{CuO}(\text{s})]\} - \{(1 \text{ mol})(-168.6 \text{ kJ/mol}) + (1/2 \text{ mol})(0 \text{ kJ/mol})\}$$

$$-146.0 \text{ kJ} = 2 \text{ mol } \Delta H_{\text{f}}^{\circ} [\text{CuO}(\text{s})] + 168.6 \text{ kJ}$$

$$\Delta H_{\text{f}}^{\circ} [\text{CuO}(\text{s})] = -\frac{314.6 \text{ kJ}}{2 \text{ mol}} = \mathbf{-157.3 \text{ kJ/mol}}$$

$$6.56 \quad \Delta H_{\text{rxn}}^{\circ} = \sum m \Delta H_{\text{f}}^{\circ}(\text{products}) - \sum n \Delta H_{\text{f}}^{\circ}(\text{reactants})$$

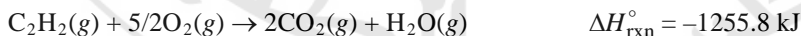

$$\Delta H_{\text{rxn}}^{\circ} = \{2 \Delta H_{\text{f}}^{\circ} [\text{CO}_2(\text{g})] + 1 \Delta H_{\text{f}}^{\circ} [\text{H}_2\text{O}(\text{g})]\} - \{1 \Delta H_{\text{f}}^{\circ} [\text{C}_2\text{H}_2(\text{g})] + 5/2 \Delta H_{\text{f}}^{\circ} [\text{O}_2(\text{g})]\}$$

$$-1255.8 \text{ kJ} = \{(2 \text{ mol})(-393.5 \text{ kJ/mol}) + (1 \text{ mol})(-241.826 \text{ kJ/mol})\}$$

$$- \{(1 \text{ mol}) \Delta H_{\text{f}}^{\circ} [\text{C}_2\text{H}_2(\text{g})] + (5/2 \text{ mol})(0.0 \text{ kJ/mol})\}$$

$$-1255.8 \text{ kJ} = -787.0 \text{ kJ} - 241.8 \text{ kJ} - (1 \text{ mol}) \Delta H_{\text{f}}^{\circ} [\text{C}_2\text{H}_2(\text{g})]$$

$$\Delta H_{\text{f}}^{\circ} [\text{C}_2\text{H}_2(\text{g})] = \frac{-227.0 \text{ kJ}}{-1 \text{ mol}} = \mathbf{227.0 \text{ kJ/mol}}$$

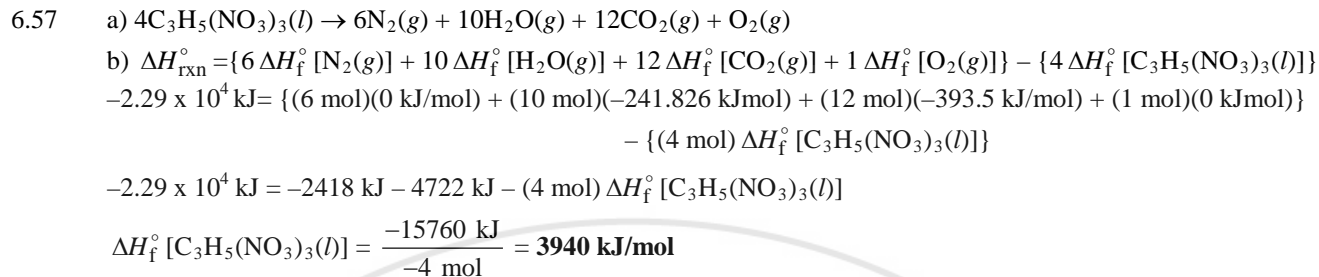

6.58 Plan: The enthalpy change of a reaction is the sum of the heats of formation of the products minus the sum of the heats of formation of the reactants. Since the  $\Delta H_f^\circ$  values (Appendix B) are reported as energy per one mole, use the appropriate stoichiometric coefficient to reflect the higher number of moles. Hess's law can also be used to calculate the enthalpy of reaction. In part b), rearrange equations 1) and 2) to give the equation wanted.

Reverse the first equation (changing the sign of  $\Delta H_{\text{rxn}}^\circ$ ) and multiply the coefficients (and  $\Delta H_{\text{rxn}}^\circ$ ) of the second reaction by 2.

Solution:

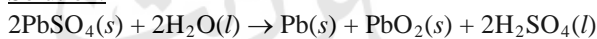

$$\Delta H_{\text{rxn}}^\circ = \sum m \Delta H_f^\circ (\text{products}) - \sum n \Delta H_f^\circ (\text{reactants})$$

$$\begin{aligned} \text{a) } \Delta H_{\text{rxn}}^\circ &= \{1 \Delta H_f^\circ [\text{Pb}(s)] + 1 \Delta H_f^\circ [\text{PbO}_2(s)] + 2 \Delta H_f^\circ [\text{H}_2\text{SO}_4(l)]\} \\ &\quad - \{2 \Delta H_f^\circ [\text{PbSO}_4(s)] + 2 \Delta H_f^\circ [\text{H}_2\text{O}(l)]\} \\ &= \{(1 \text{ mol})(0 \text{ kJ/mol}) + (1 \text{ mol})(-276.6 \text{ kJ/mol}) + (2 \text{ mol})(-813.989 \text{ kJ/mol})\} \\ &\quad - \{(2 \text{ mol})(-918.39 \text{ kJ/mol}) + (2 \text{ mol})(-285.840 \text{ kJ/mol})\} \\ &= \mathbf{503.9 \text{ kJ}} \end{aligned}$$

b) Use Hess's law:

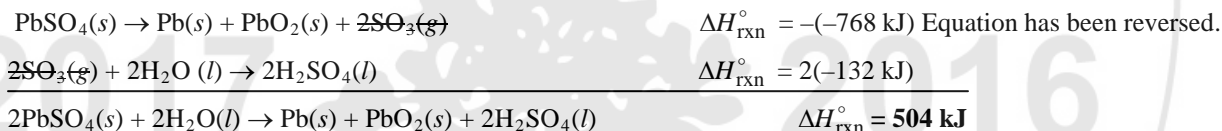

6.59 Plan: The enthalpy change of a reaction is the sum of the heats of formation of the products minus the sum of the heats of formation of the reactants. Since the  $\Delta H_f^\circ$  values (Appendix B) are reported as energy per one mole, use the appropriate stoichiometric coefficient to reflect the higher number of moles. Convert the mass of stearic acid to moles and use the ratio between stearic acid and  $\Delta H_{\text{rxn}}^\circ$  to find the heat involved for this amount of acid. For part d), use the kcal/g of fat relationship calculated in part c) to convert 11.0 g of fat to total kcal and compare to the 100. Cal amount.

Solution:

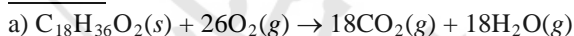

b)  $\Delta H_{\text{rxn}}^\circ = \sum m \Delta H_f^\circ (\text{products}) - \sum n \Delta H_f^\circ (\text{reactants})$

$$\begin{aligned} \Delta H_{\text{rxn}}^\circ &= \{18 \Delta H_f^\circ [\text{CO}_2(g)] + 18 \Delta H_f^\circ [\text{H}_2\text{O}(g)]\} - \{1 \Delta H_f^\circ [\text{C}_{18}\text{H}_{36}\text{O}_2(s)] + 26 \Delta H_f^\circ [\text{O}_2(g)]\} \\ &= \{(18 \text{ mol})(-393.5 \text{ kJ/mol}) + (18 \text{ mol})(-241.826 \text{ kJ/mol})\} - \{(1 \text{ mol})(-948 \text{ kJ/mol}) + (26 \text{ mol})(0 \text{ kJ/mol})\} \\ &= -10,487.868 = \mathbf{-10,488 \text{ kJ}} \end{aligned}$$

$$\text{c) } q \text{ (kJ)} = (1.00 \text{ g C}_{18}\text{H}_{36}\text{O}_2) \left( \frac{1 \text{ mol C}_{18}\text{H}_{36}\text{O}_2}{284.47 \text{ C}_{18}\text{H}_{36}\text{O}_2} \right) \left( \frac{-10,487.868 \text{ kJ}}{1 \text{ mol C}_{18}\text{H}_{36}\text{O}_2} \right) = -36.8681 = \mathbf{-36.9 \text{ kJ}}$$

$$q \text{ (kcal)} = (-36.8681 \text{ kJ}) \left( \frac{1 \text{ kcal}}{4.184 \text{ kJ}} \right) = -8.811688 = \mathbf{-8.81 \text{ kcal}}$$

$$d) q \text{ (kcal)} = (11.0 \text{ g fat}) \left[ \frac{-8.811688 \text{ kcal}}{1.0 \text{ g fat}} \right] = 96.9286 = \mathbf{96.9 \text{ kcal}}$$

Since 1 kcal = 1 Cal, 96.9 kcal = 96.9 Cal. The calculated calorie content is consistent with the package information.

- 6.60 Plan: Use the ideal gas law,  $PV = nRT$ , to calculate the volume of one mole of helium at each temperature. Then use the given equation for  $\Delta E$  to find the change in internal energy. The equation for work,  $w = -P\Delta V$ , is needed for part c), and  $q_p = \Delta E + P\Delta V$  is used for part d). For part e), recall that  $\Delta H = q_p$ .

Solution:

$$a) PV = nRT \text{ or } V = \frac{nRT}{P}$$

$$T = 273 + 15 = 288 \text{ K} \quad \text{and} \quad T = 273 + 30 = 303 \text{ K}$$

$$\text{Initial volume (L)} = V = \frac{nRT}{P} = \frac{(0.0821 \frac{\text{L}\cdot\text{atm}}{\text{mol}\cdot\text{K}})(288 \text{ K})}{(1.00 \text{ atm})} = 23.6448 = \mathbf{23.6 \text{ L/mol}}$$

$$\text{Final volume (L)} = V = \frac{nRT}{P} = \frac{(0.0821 \frac{\text{L}\cdot\text{atm}}{\text{mol}\cdot\text{K}})(303 \text{ K})}{(1.00 \text{ atm})} = 24.8763 = \mathbf{24.9 \text{ L/mol}}$$

b) Internal energy is the sum of the potential and kinetic energies of each He atom in the system (the balloon). The energy of one mole of helium atoms can be described as a function of temperature,  $E = 3/2nRT$ , where  $n = 1$  mole. Therefore, the internal energy at 15°C and 30°C can be calculated. The inside back cover lists values of  $R$  with different units.

$$E = 3/2nRT = (3/2)(1.00 \text{ mol})(8.314 \text{ J/mol}\cdot\text{K})(303 - 288)\text{K} = 187.065 = \mathbf{187 \text{ J}}$$

c) When the balloon expands as temperature rises, the balloon performs  $PV$  work. However, the problem specifies that pressure remains constant, so work done on the surroundings by the balloon is defined by the equation:

$w = -P\Delta V$ . When pressure and volume are multiplied together, the unit is  $\text{L}\cdot\text{atm}$ , so a conversion factor is needed to convert work in units of  $\text{L}\cdot\text{atm}$  to joules.

$$w = -P\Delta V = -(1.00 \text{ atm})((24.8763 - 23.6448) \text{ L}) \left( \frac{101.3 \text{ J}}{1 \text{ L}\cdot\text{atm}} \right) = -124.75 = \mathbf{-1.2 \times 10^2 \text{ J}}$$

$$d) q_p = \Delta E + P\Delta V = (187.065 \text{ J}) + (124.75 \text{ J}) = 311.815 = \mathbf{3.1 \times 10^2 \text{ J}}$$

$$e) \Delta H = q_p = \mathbf{310 \text{ J}}$$

f) When a process occurs at constant pressure, the change in heat energy of the system can be described by a state function called enthalpy. The change in enthalpy equals the heat ( $q$ ) lost at constant pressure:  $\Delta H = \Delta E + P\Delta V = \Delta E - w = (q + w) - w = q_p$

- 6.61 a) Respiration:

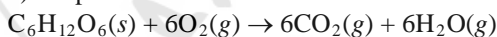

$$\Delta H_{\text{rxn}}^\circ = \sum m \Delta H_f^\circ(\text{products}) - \sum n \Delta H_f^\circ(\text{reactants})$$

$$= \{6 \Delta H_f^\circ[\text{CO}_2(g)] + 6 \Delta H_f^\circ[\text{H}_2\text{O}(g)]\} - \{1 \Delta H_f^\circ[\text{C}_6\text{H}_{12}\text{O}_6(s)] + 6 \Delta H_f^\circ[\text{O}_2(g)]\}$$

$$= [(6 \text{ mol})(-393.5 \text{ kJ/mol}) + (6 \text{ mol})(-241.826 \text{ kJ/mol})] - [(1 \text{ mol})(-1273.3 \text{ kJ/mol}) + (6 \text{ mol})(0.0 \text{ kJ/mol})]$$

$$= -2538.656 = \mathbf{-2538.7 \text{ kJ}}$$

Fermentation:

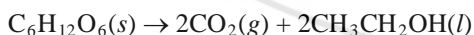

$$\Delta H_{\text{rxn}}^\circ = \{2 \Delta H_f^\circ[\text{CO}_2(g)] + 2 \Delta H_f^\circ[\text{CH}_3\text{CH}_2\text{OH}(l)]\} - [1 \Delta H_f^\circ[\text{C}_6\text{H}_{12}\text{O}_6(s)]]$$

$$= [(2 \text{ mol})(-393.5 \text{ kJ/mol}) + (2 \text{ mol})(-277.63 \text{ kJ/mol})] - [(1 \text{ mol})(-1273.3 \text{ kJ/mol})] = -68.96 = \mathbf{-69.0 \text{ kJ}}$$

b) Combustion of ethanol:

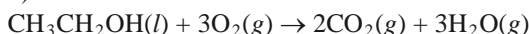

$$\Delta H_{\text{rxn}}^\circ = \{2 \Delta H_f^\circ[\text{CO}_2(g)] + 3 \Delta H_f^\circ[\text{H}_2\text{O}(g)]\} - \{1 \Delta H_f^\circ[\text{CH}_3\text{CH}_2\text{OH}(l)] + 3 \Delta H_f^\circ[\text{O}_2(g)]\}$$

$$\Delta H_{\text{rxn}}^{\circ} = [(2 \text{ mol})(-393.5 \text{ kJ/mol}) + (3 \text{ mol})(-241.826 \text{ kJ/mol})] - [(1 \text{ mol})(-277.63 \text{ kJ/mol}) + (3 \text{ mol})(0.0 \text{ kJ/mol})]$$

$$= -1234.848 = -\mathbf{1234.8 \text{ kJ}}$$

Heats of combustion/mol C:

$$\text{Sugar: } \left( \frac{-2538.656 \text{ kJ}}{1 \text{ mol C}_6\text{H}_{12}\text{O}_6} \right) \left( \frac{1 \text{ mol C}_6\text{H}_{12}\text{O}_6}{6 \text{ mol C}} \right) = -423.1093 = -423.11 \text{ kJ/mol C}$$

$$\text{Ethanol: } \left( \frac{-1234.848 \text{ kJ}}{1 \text{ mol CH}_3\text{CH}_2\text{OH}} \right) \left( \frac{1 \text{ mol CH}_3\text{CH}_2\text{OH}}{2 \text{ mol C}} \right) = -617.424 = -617.42 \text{ kJ/mol C}$$

**Ethanol** has a higher value.

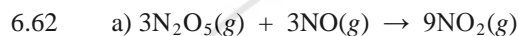

$$\Delta H_{\text{rxn}}^{\circ} = \{9 \Delta H_f^{\circ} [\text{NO}_2(\text{g})]\} - \{3 \Delta H_f^{\circ} [\text{N}_2\text{O}_5(\text{g})] + 3 \Delta H_f^{\circ} [\text{NO}(\text{g})]\}$$

$$= [(9 \text{ mol})(33.2 \text{ kJ/mol})] - [(3 \text{ mol})(11 \text{ kJ/mol}) + (3 \text{ mol})(90.29 \text{ kJ/mol})]$$

$$= -5.07 = -\mathbf{5 \text{ kJ}}$$

b) (9 molecules product)  $\left( \frac{1.50 \times 10^{-2} \text{ mol}}{1 \text{ molecule product}} \right) \left( \frac{-5.07 \text{ kJ}}{9 \text{ moles product}} \right) \left( \frac{10^3 \text{ J}}{1 \text{ kJ}} \right) = -76.05 = -\mathbf{76.0 \text{ J}}$

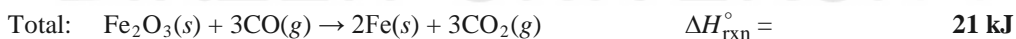
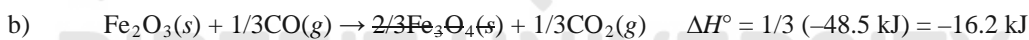
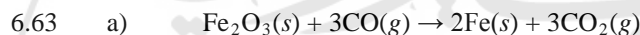

6.64 a) Heat =  $(20.4 \text{ gal}) \left( \frac{4 \text{ qt}}{1 \text{ gal}} \right) \left( \frac{1 \text{ L}}{1.057 \text{ qt}} \right) \left( \frac{1 \text{ mL}}{10^{-3} \text{ L}} \right) \left( \frac{0.702 \text{ g}}{\text{mL}} \right) \left( \frac{1 \text{ mol C}_8\text{H}_{18}}{114.22 \text{ g}} \right) \left( \frac{-5.45 \times 10^3 \text{ kJ}}{1 \text{ mol C}_8\text{H}_{18}} \right)$

$$= -2.585869657 \times 10^6 = -\mathbf{2.59 \times 10^6 \text{ kJ}}$$

b) Miles =  $(-2.585869657 \times 10^6 \text{ kJ}) \left( \frac{1 \text{ h}}{-5.5 \times 10^4 \text{ kJ}} \right) \left( \frac{65 \text{ mi}}{1 \text{ h}} \right) \left( \frac{1 \text{ km}}{0.62 \text{ mi}} \right) = 4929.1 = \mathbf{4.9 \times 10^3 \text{ km}}$

c) Only a small percentage of the chemical energy in the fuel is converted to work to move the car; most of the chemical energy is lost as waste heat flowing into the surroundings.

6.65  $q = c \times \text{mass} \times \Delta T$

In this situation, all of the samples have the same mass, 50. g, so mass is not a variable.

All also have the same  $q$  value, 450. J. So, 450. J  $\propto (c \times \Delta T)$ .  $c$ , specific heat capacity, and  $\Delta T$  are inversely proportional. The higher the  $\Delta T$ , the lower the value of specific heat capacity:

$$\Delta T: \text{B} > \text{D} > \text{C} > \text{A}$$

Specific heat capacity:  $\mathbf{B < D < C < A}$



$$\Delta H_{\text{rxn}}^{\circ} = [(1 \text{ mol sucrose})(-2226 \text{ kJ/mol}) + (1 \text{ mol H}_2\text{O})(-285.840 \text{ kJ/mol})] - [(1 \text{ mol glucose})(-1273 \text{ kJ/mol}) + (1 \text{ mol fructose})(-1266 \text{ kJ/mol})] = \mathbf{27 \text{ kJ/mol sucrose}}$$

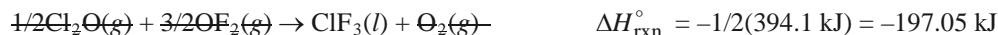

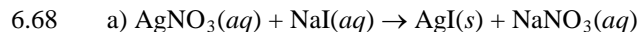

$$\begin{aligned} \text{Moles of AgNO}_3 &= (50.0 \text{ mL}) \left( \frac{10^{-3} \text{ L}}{1 \text{ mL}} \right) \left( \frac{5.0 \text{ g AgNO}_3}{1 \text{ L}} \right) \left( \frac{1 \text{ mol AgNO}_3}{169.9 \text{ g AgNO}_3} \right) \\ &= 1.47145 \times 10^{-3} \text{ mol AgNO}_3 \end{aligned}$$

$$\begin{aligned} \text{Moles of NaI} &= (50.0 \text{ mL}) \left( \frac{10^{-3} \text{ L}}{1 \text{ mL}} \right) \left( \frac{5.0 \text{ g NaI}}{1 \text{ L}} \right) \left( \frac{1 \text{ mol NaI}}{149.9 \text{ g NaI}} \right) \\ &= 1.6677785 \times 10^{-3} \text{ mol NaI} \end{aligned}$$

The  $\text{AgNO}_3$  is limiting, and will be used to finish the problem:

$$\begin{aligned} \text{Mass (g) of AgI} &= (1.47145 \times 10^{-3} \text{ mol AgNO}_3) \left( \frac{1 \text{ mol AgI}}{1 \text{ mol AgNO}_3} \right) \left( \frac{234.8 \text{ g AgI}}{1 \text{ mol AgI}} \right) \\ &= 0.345496 = \mathbf{0.35 \text{ g AgI}} \end{aligned}$$

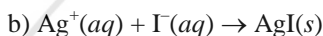

$$\begin{aligned} \Delta H_{\text{rxn}}^\circ &= \{1 \Delta H_f^\circ [\text{AgI}(s)]\} - \{1 \Delta H_f^\circ [\text{Ag}^+(aq)] + 1 \Delta H_f^\circ [\text{I}^-(aq)]\} \\ &= [(1 \text{ mol})(-62.38 \text{ kJ/mol})] - [(1 \text{ mol})(105.9 \text{ kJ/mol}) + (1 \text{ mol})(-55.94 \text{ kJ/mol})] \\ &= \mathbf{-112.3 \text{ kJ}} \end{aligned}$$

c)  $\Delta H_{\text{rxn}}^\circ = q = c \times \text{mass} \times \Delta T$

$$\begin{aligned} \Delta T &= \frac{\Delta H_{\text{rxn}}^\circ / c \times \text{mass}}{\left( \frac{112.3 \text{ kJ}}{\text{mol AgI}} \right) \left( \frac{1 \text{ mol AgI}}{1 \text{ mol AgNO}_3} \right) (1.47145 \times 10^{-3} \text{ mol AgNO}_3)} \left( \frac{10^3 \text{ J}}{1 \text{ kJ}} \right) \\ &= \frac{\left( \frac{4.184 \text{ J}}{\text{g} \cdot \text{K}} \right) \left[ (50.0 + 50.0) \text{ mL} \left( \frac{1.00 \text{ g}}{\text{mL}} \right) \right]}{\left( \frac{112.3 \text{ kJ}}{\text{mol AgI}} \right) \left( \frac{1 \text{ mol AgI}}{1 \text{ mol AgNO}_3} \right) (1.47145 \times 10^{-3} \text{ mol AgNO}_3)} \left( \frac{10^3 \text{ J}}{1 \text{ kJ}} \right) \\ &= 0.39494 = \mathbf{0.39 \text{ K}} \end{aligned}$$

6.69 a) Mass (kg) of =  $(5600 \text{ EJ}) \left( \frac{10^{18} \text{ J}}{1 \text{ EJ}} \right) \left( \frac{1 \text{ kJ}}{10^3 \text{ J}} \right) \left( \frac{1 \text{ mol CH}_4}{802 \text{ kJ}} \right) \left( \frac{16.04 \text{ g CH}_4}{1 \text{ mol CH}_4} \right) \left( \frac{1 \text{ kg}}{10^3 \text{ g}} \right) = \mathbf{1.12 \times 10^{14} \text{ kg CH}_4}$

b) Years =  $(5600 \text{ EJ}) \left( \frac{1 \text{ yr}}{4.0 \times 10^2 \text{ EJ}} \right) = \mathbf{14 \text{ yr}}$

c) Moles of  $\text{CH}_4 = (1.00 \text{ qt}) \left( \frac{1 \text{ L}}{1.057 \text{ qt}} \right) \left( \frac{1 \text{ mL}}{10^{-3} \text{ L}} \right) \left( \frac{1.00 \text{ g}}{\text{mL}} \right) \left( \frac{4.184 \text{ J}}{\text{g} \cdot \text{C}} \right) ((100.0 - 25.0)^\circ\text{C}) \left( \frac{1 \text{ kJ}}{10^3 \text{ J}} \right) \left( \frac{1 \text{ mol CH}_4}{802 \text{ kJ}} \right)$   
 $= 0.370172 \text{ mol CH}_4$

Volume ( $\text{ft}^3$ ) of  $\text{CH}_4 = (0.370172 \text{ mol CH}_4) \left( \frac{16.04 \text{ g CH}_4}{1 \text{ mol CH}_4} \right) \left( \frac{1 \text{ L}}{0.72 \text{ g CH}_4} \right) \left( \frac{10^{-3} \text{ m}^3}{1 \text{ L}} \right) \left( \frac{35.3 \text{ ft}^3}{1 \text{ m}^3} \right)$   
 $= 0.291105 = \mathbf{0.29 \text{ ft}^3}$

d) Volume =  $(2 \times 10^{13} \text{ J}) \left( \frac{1 \text{ kJ}}{10^3 \text{ J}} \right) \left( \frac{1 \text{ mol CH}_4}{802 \text{ kJ}} \right) \left( \frac{16.04 \text{ g CH}_4}{1 \text{ mol CH}_4} \right) \left( \frac{1 \text{ L}}{0.72 \text{ g CH}_4} \right) \left( \frac{10^{-3} \text{ m}^3}{1 \text{ L}} \right) \left( \frac{35.3 \text{ ft}^3}{1 \text{ m}^3} \right)$   
 $= 1.9611 \times 10^7 = \mathbf{2 \times 10^7 \text{ ft}^3}$

6.70 Plan: Chemical equations can be written that describe the three processes. Assume one mole of each substance of interest so that units are expressed as kJ. To obtain the overall reaction, reverse the third reaction and multiply its coefficients by two and add to the first two reactions. When the third reaction is reversed, the sign of its enthalpy change is reversed from positive to negative.

Solution:

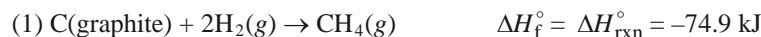



The third equation is reversed and its coefficients are multiplied by 2 to add the three equations.

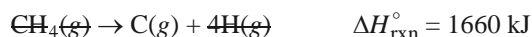
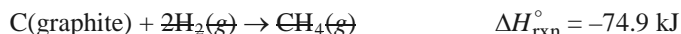

- 6.71 The reaction is **exothermic**. The argon atoms in the chamber after the reaction are moving with greater kinetic energy, indicating an increase in temperature.
- 6.72 Plan: Write balanced chemical equations for the combustion reactions and use the standard heats of formation to determine the energy released.

Solution:

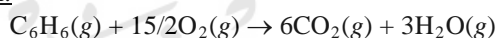

$$\Delta H_{\text{rxn}}^{\circ} = \{6 \Delta H_f^{\circ} [\text{CO}_2(g)] + 3 \Delta H_f^{\circ} [\text{H}_2\text{O}(g)]\} - \{1 \Delta H_f^{\circ} [\text{C}_6\text{H}_6(g)] + 15/2 \Delta H_f^{\circ} [\text{O}_2(g)]\}$$

$$\Delta H_{\text{rxn}}^{\circ} = [(6 \text{ mol})(-393.5 \text{ kJ/mol}) + (3 \text{ mol})(-241.826 \text{ kJ/mol})] - [(1 \text{ mol})(82.9 \text{ kJ/mol}) + (15/2 \text{ mol})(0.0 \text{ kJ/mol})]$$

$$= -3169.378$$

$$\Delta H_{\text{rxn}}^{\circ} \text{ per mole of CH} = \left( \frac{-3169.378 \text{ kJ}}{\text{mol C}_6\text{H}_6} \right) \left( \frac{1 \text{ mol C}_6\text{H}_6}{6 \text{ mol CH}} \right) = -528.2297 = \mathbf{-528.2 \text{ kJ/mol CH}}$$

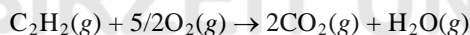

$$\Delta H_{\text{rxn}}^{\circ} = \{2 \Delta H_f^{\circ} [\text{CO}_2(g)] + 1 [\Delta H_f^{\circ} [\text{H}_2\text{O}(g)]]\} - \{1 \Delta H_f^{\circ} [\text{C}_2\text{H}_2(g)] + 5/2 \Delta H_f^{\circ} [\text{O}_2(g)]\}$$

$$\Delta H_{\text{rxn}}^{\circ} = [(2 \text{ mol})(-393.5 \text{ kJ/mol}) + (1 \text{ mol})(-241.826 \text{ kJ/mol})] - [(1 \text{ mol})(227 \text{ kJ/mol}) + (5/2 \text{ mol})(0.0 \text{ kJ/mol})]$$

$$= -1255.826 \text{ kJ}$$

$$\Delta H_{\text{rxn}}^{\circ} \text{ per mole of CH} = \left( \frac{-1255.826 \text{ kJ}}{\text{mol C}_2\text{H}_2} \right) \left( \frac{1 \text{ mol C}_2\text{H}_2}{2 \text{ mol CH}} \right) = -627.913 = \mathbf{-628 \text{ kJ/mol CH}}$$

Thus, acetylene releases more energy per CH than benzene does.

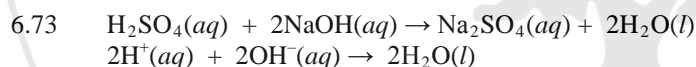

$$\Delta H_{\text{rxn}}^{\circ} = \{2 \Delta H_f^{\circ} [\text{H}_2\text{O}(l)]\} - \{2 \Delta H_f^{\circ} [\text{H}^+(aq)] + 2 \Delta H_f^{\circ} [\text{OH}^-(aq)]\}$$

$$= [(2 \text{ mol})(-285.84 \text{ kJ/mol})] - [(2 \text{ mol})(0 \text{ kJ/mol}) + (2 \text{ mol})(-229.94 \text{ kJ/mol})]$$

$$= -111.8 \text{ kJ}$$

1 mole of  $\text{H}_2\text{SO}_4$  reacts with 2 moles of NaOH.

$$\text{Mass (g) of H}_2\text{SO}_4 \text{ solution} = (1 \text{ mol H}_2\text{SO}_4) \left( \frac{1.00 \text{ L}}{0.50 \text{ mol H}_2\text{SO}_4} \right) \left( \frac{1.00 \text{ mL}}{10^{-3} \text{ L}} \right) \left( \frac{1.030 \text{ g}}{1.00 \text{ mL}} \right)$$

$$= 2060 \text{ g H}_2\text{SO}_4 \text{ solution}$$

$$\text{Mass (g) of NaOH solution} = (2 \text{ mol NaOH}) \left( \frac{40.00 \text{ g NaOH}}{1 \text{ mol NaOH}} \right) \left( \frac{100 \text{ g solution}}{40 \text{ g NaOH}} \right) = 200. \text{ g NaOH solution}$$

$$q = c \times \text{mass} \times \Delta T$$

$$\Delta T = \frac{q}{c \times \text{mass}} = \frac{(111.8 \text{ kJ}) \left( \frac{10^3 \text{ J}}{1 \text{ kJ}} \right)}{4.184 \text{ J/g}^{\circ}\text{C}((2060 + 200) \text{ g})} = 11.82^{\circ}\text{C}$$

$$31^{\circ}\text{C} + 11.82^{\circ}\text{C} = 42.82 = 43^{\circ}\text{C}$$

This temperature is above the temperature at which a flammable vapor could be formed so the temperature increase could cause the vapor to explode.

6.74 a)  $2\text{C}_{12}\text{H}_{26}(l) + 37\text{O}_2(g) \rightarrow 24\text{CO}_2(g) + 26\text{H}_2\text{O}(g)$   
 b)  $\Delta H_{\text{rxn}}^{\circ} = \{24 \Delta H_f^{\circ} [\text{CO}_2(g)] + 26 \Delta H_f^{\circ} [\text{H}_2\text{O}(g)]\} - \{2 \Delta H_f^{\circ} [\text{C}_{12}\text{H}_{26}(g)] + 37 \Delta H_f^{\circ} [\text{O}_2(g)]\}$   
 $-1.50 \times 10^4 \text{ kJ} = [(24 \text{ mol})(-393.5 \text{ kJ/mol}) + (26 \text{ mol})(-241.826 \text{ kJ/mol})]$   
 $- [(2 \text{ mol}) \Delta H_f^{\circ} [\text{C}_{12}\text{H}_{26}(g)] + (37 \text{ mol})(0.0 \text{ kJ/mol})]$   
 $-1.50 \times 10^4 \text{ kJ} = -9444.0 \text{ kJ} + -6287.476 \text{ kJ} - [(2 \text{ mol}) \Delta H_f^{\circ} [\text{C}_{12}\text{H}_{26}(g)] + 0.0 \text{ kJ}]$   
 $-1.50 \times 10^4 \text{ kJ} = -15,731.476 \text{ kJ} - (2 \text{ mol}) \Delta H_f^{\circ} [\text{C}_{12}\text{H}_{26}(g)]$   
 $-1.50 \times 10^4 \text{ kJ} + 15,731.476 \text{ kJ} = -(2 \text{ mol}) \Delta H_f^{\circ} [\text{C}_{12}\text{H}_{26}(g)]$   
 $731.476 \text{ kJ} = -(2 \text{ mol}) \Delta H_f^{\circ} [\text{C}_{12}\text{H}_{26}(g)]$   
 $\Delta H_f^{\circ} [\text{C}_{12}\text{H}_{26}(g)] = -365.738 = -\mathbf{3.66 \times 10^2 \text{ kJ}}$

c) Heat (kJ) =  $(0.50 \text{ gal}) \left( \frac{4 \text{ qt}}{1 \text{ gal}} \right) \left( \frac{1 \text{ L}}{1.057 \text{ qt}} \right) \left( \frac{1 \text{ mL}}{10^{-3} \text{ L}} \right) \left( \frac{0.749 \text{ g C}_{12}\text{H}_{26}}{\text{mL}} \right) \left( \frac{1 \text{ mol C}_{12}\text{H}_{26}}{170.33 \text{ g C}_{12}\text{H}_{26}} \right) \left( \frac{-1.50 \times 10^4 \text{ kJ}}{2 \text{ mol C}_{12}\text{H}_{26}} \right)$   
 $= -6.2403 \times 10^4 = -\mathbf{6.2 \times 10^4 \text{ kJ}}$

d) Volume (gal) =  $(1250. \text{ Btu}) \left( \frac{1.055 \text{ kJ}}{1 \text{ Btu}} \right) \left( \frac{0.50 \text{ gal}}{6.2403 \times 10^4 \text{ kJ}} \right) = 0.010566 = \mathbf{1.1 \times 10^{-2} \text{ gal}}$

6.75 Use Hess's Law:

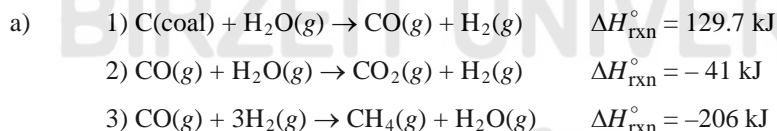

Equation 1) must be multiplied by 2 and then the reactions are added:

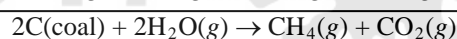
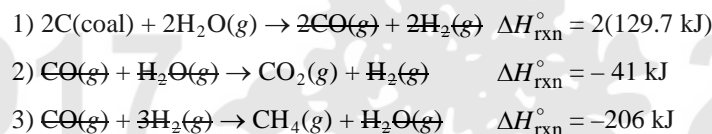

b) The total may be determined by doubling the value for equation 1) and adding to the other two values.

$\Delta H_{\text{rxn}}^{\circ} = 2(129.7 \text{ kJ}) + (-41 \text{ kJ}) + (-206 \text{ kJ}) = 12.4 = \mathbf{12 \text{ kJ}}$

c) Calculating the heat of combustion of  $\text{CH}_4$ :

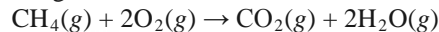

$\Delta H_{\text{comb}}^{\circ} = \{1 \Delta H_f^{\circ} [\text{CO}_2(g)] + 2 \Delta H_f^{\circ} [\text{H}_2\text{O}(g)]\} - \{1 \Delta H_f^{\circ} [\text{CH}_4(g)] + 2 \Delta H_f^{\circ} [\text{O}_2(g)]\}$

$\Delta H_{\text{comb}}^{\circ} = [(1 \text{ mol})(-395.5 \text{ kJ/mol}) + (2 \text{ mol})(-241.826 \text{ kJ/mol})]$   
 $- [(1 \text{ mol})(-74.87 \text{ kJ/mol}) - (2 \text{ mol})(0.0 \text{ kJ/mol})]$   
 $= -804.282 \text{ kJ/mol CH}_4$

Total heat for gasification of 1.00 kg coal:

$\Delta H^{\circ} = (1.00 \text{ kg coal}) \left( \frac{10^3 \text{ g}}{1 \text{ kg}} \right) \left( \frac{1 \text{ mol coal}}{12.00 \text{ g coal}} \right) \left( \frac{12.4 \text{ kJ}}{2 \text{ mol coal}} \right) = 516.667 \text{ kJ}$

Total heat from burning the methane formed from 1.00 kg of coal:

$\Delta H^{\circ} = (1.00 \text{ kg coal}) \left( \frac{10^3 \text{ g}}{1 \text{ kg}} \right) \left( \frac{1 \text{ mol coal}}{12.00 \text{ g coal}} \right) \left( \frac{1 \text{ mol CH}_4}{2 \text{ mol coal}} \right) \left( \frac{-804.282 \text{ kJ}}{1 \text{ mol CH}_4} \right)$   
 $= -33511.75 \text{ kJ}$

Total heat =  $516.667 \text{ kJ} - 33511.75 \text{ kJ} = 32995.083 = \mathbf{3.30 \times 10^4 \text{ kJ}}$



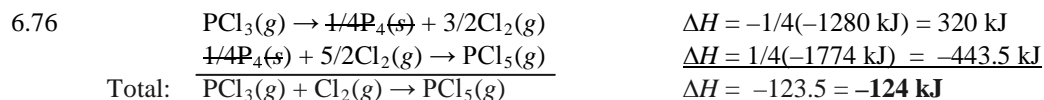

$$6.77 \quad \text{a) Energy (kJ)} = (2 \text{ oz}) \left( \frac{28.4 \text{ g}}{1.00 \text{ oz}} \right) \left( \frac{4.0 \text{ Cal}}{1.0 \text{ g}} \right) \left( \frac{1 \text{ kcal}}{1 \text{ Cal}} \right) \left( \frac{4.184 \text{ kJ}}{1 \text{ kcal}} \right) = 950.60 = \mathbf{1 \times 10^3 \text{ kJ}}$$

$$\text{b) Energy} = E = \text{mass} \times g \times \text{height} = mgh$$

$$h = \frac{E}{mg} = \frac{(950.60 \text{ kJ})}{(58 \text{ kg})(9.8 \text{ m/s}^2)} \left( \frac{10^3 \text{ J}}{1 \text{ kJ}} \right) \left( \frac{\text{kg} \cdot \text{m}^2/\text{s}^2}{\text{J}} \right) = 1672.41 = 2 \times 10^3 \text{ m}$$

c) Energy is also converted to heat.

6.78 Plan: Heat of reaction is calculated using the relationship  $\Delta H_{\text{rxn}}^\circ = \sum m \Delta H_f^\circ(\text{products}) - \sum n \Delta H_f^\circ(\text{reactants})$ . The heats of formation for all of the species, except  $\text{SiCl}_4$ , are found in Appendix B. Use reaction 3, with its given  $\Delta H_{\text{rxn}}^\circ$ , to find the heat of formation of  $\text{SiCl}_4(g)$ . Once the heat of formation of  $\text{SiCl}_4$  is known, the heat of reaction of the other two reactions can be calculated. When reactions 2 and 3 are added to obtain a fourth reaction, the heats of reaction of reactions 2 and 3 are also added to obtain the heat of reaction for the fourth reaction.

Solution:



$$\begin{aligned}
 \Delta H_{\text{rxn}}^\circ &= \{1 \Delta H_f^\circ[\text{SiO}_2(s)] + 4 \Delta H_f^\circ[\text{HCl}(g)]\} - \{1 \Delta H_f^\circ[\text{SiCl}_4(g)] + 2 \Delta H_f^\circ[\text{H}_2\text{O}(g)]\} \\
 -139.5 \text{ kJ} &= [(1 \text{ mol})(-910.9 \text{ kJ/mol}) + (4 \text{ mol})(-92.31 \text{ kJ/mol})] - [\Delta H_f^\circ[\text{SiCl}_4(g)] + (2 \text{ mol})(-241.826 \text{ kJ/mol})] \\
 -139.5 \text{ kJ} &= -1280.14 - [\Delta H_f^\circ[\text{SiCl}_4(g)] + (-483.652 \text{ kJ})]
 \end{aligned}$$

$$1140.64 \text{ kJ} = -\Delta H_f^\circ[\text{SiCl}_4(g)] + 483.652 \text{ kJ}$$

$$\Delta H_f^\circ[\text{SiCl}_4(g)] = -656.988 \text{ kJ/mol}$$

The heats of reaction for the first two steps can now be calculated.



$$\begin{aligned}
 \Delta H_{\text{rxn}}^\circ &= \{1 \Delta H_f^\circ[\text{SiCl}_4(g)]\} - \{1 \Delta H_f^\circ[\text{Si}(s)] + 2 \Delta H_f^\circ[\text{Cl}_2(g)]\} \\
 &= [(1 \text{ mol})(-656.988 \text{ kJ/mol})] - [(1 \text{ mol})(0 \text{ kJ/mol}) + (2 \text{ mol})(0 \text{ kJ/mol})] = -656.988 = \mathbf{-657.0 \text{ kJ}}
 \end{aligned}$$



$$\begin{aligned}
 \Delta H_{\text{rxn}}^\circ &= \{1 \Delta H_f^\circ[\text{SiCl}_4(g)] + 2 \Delta H_f^\circ[\text{CO}(g)]\} \\
 &\quad - \{1 \Delta H_f^\circ[\text{SiO}_2(s)] + 2 \Delta H_f^\circ[\text{C}(\text{graphite})] + 2 \Delta H_f^\circ[\text{Cl}_2(g)]\} \\
 &= [(1 \text{ mol})(-656.988 \text{ kJ/mol}) + (2 \text{ mol})(-110.5 \text{ kJ/mol})] \\
 &\quad - [(1 \text{ mol})(-910.9 \text{ kJ/mol}) + (2 \text{ mol})(0 \text{ kJ/mol}) + (2 \text{ mol})(0 \text{ kJ/mol})] \\
 &= 32.912 = \mathbf{32.9 \text{ kJ}}
 \end{aligned}$$

b) Adding reactions 2 and 3 yields:

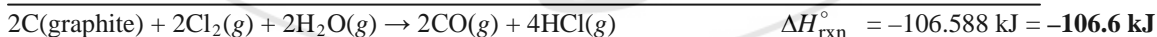
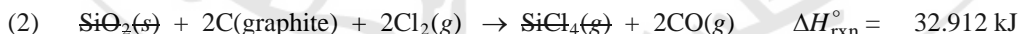

Confirm this result by calculating  $\Delta H_{\text{rxn}}^\circ$  using Appendix B values.



$$\begin{aligned}
 \Delta H_{\text{rxn}}^\circ &= \{2 \Delta H_f^\circ[\text{CO}(g)] + 4 \Delta H_f^\circ[\text{HCl}(g)]\} - \{2 \Delta H_f^\circ[\text{C}(\text{graphite})] + 2 \Delta H_f^\circ[\text{Cl}_2(g)] + 2 \Delta H_f^\circ[\text{H}_2\text{O}(g)]\} \\
 &= [(2 \text{ mol})(-110.5 \text{ kJ/mol}) + (4 \text{ mol})(-92.31 \text{ kJ/mol})] \\
 &\quad - [(2 \text{ mol})(0 \text{ kJ/mol}) + (2 \text{ mol})(0 \text{ kJ/mol}) + (2 \text{ mol})(-241.826 \text{ kJ/mol})] \\
 &= -106.588 = \mathbf{-106.6 \text{ kJ}}
 \end{aligned}$$

6.79 This is a Hess's Law problem.  $\Delta H_f^\circ$  of HCl [ $1/2\text{H}_2(\text{g}) + 1/2\text{Cl}_2(\text{g}) \rightarrow \text{HCl}(\text{g})$ ] must be found using the following equations:



Reverse equation 1 and divide by 2; divide equation 2 by 2; finally, reverse equation 3. This gives:

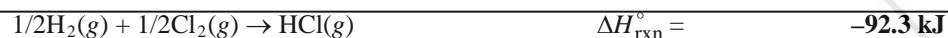
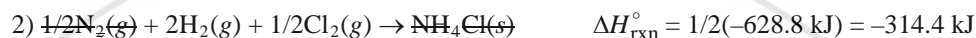

6.80 a)  $-q_{\text{rxn}} = q_{\text{water}} + q_{\text{calorimeter}}$

$$-q_{\text{rxn}} = (50.0 \text{ mL}) \left( \frac{10^{-3} \text{ L}}{1 \text{ mL}} \right) \left( \frac{2.00 \text{ mol}}{\text{L}} \right) \left( \frac{-57.32 \text{ kJ}}{\text{mol}} \right) = 5.732 \text{ kJ}$$

$$q_{\text{water}} = (\text{mass})(c)(\Delta T)$$

$$\left[ 100.0 \text{ mL} \left( \frac{1.04 \text{ g}}{\text{mL}} \right) \right] \left[ 3.93 \frac{\text{J}}{\text{g}^\circ\text{C}} \right] \left[ (30.4 - 16.9)^\circ\text{C} \right] \left( \frac{1 \text{ kJ}}{10^3 \text{ J}} \right) = 5.51772 \text{ kJ}$$

$$q_{\text{calorimeter}} = q_{\text{rxn}} - q_{\text{water}} = (5.732 \text{ kJ}) - (5.51772 \text{ kJ}) = 0.21428 \text{ kJ}$$

$$C_{\text{calorimeter}} = q_{\text{calorimeter}}/\Delta T = (0.21428 \text{ kJ})/(30.4 - 16.9)^\circ\text{C} = 0.01587 = \mathbf{0.016 \text{ kJ}^\circ\text{C}}$$

$$\text{b) Mole HCl} = (100.0 \text{ mL}) \left( \frac{10^{-3} \text{ L}}{1 \text{ mL}} \right) \left( \frac{1.00 \text{ mol HCl}}{\text{L}} \right) = 0.100 \text{ mol HCl}$$

$$\text{Mole Zn} = (1.3078 \text{ g Zn}) \left( \frac{1 \text{ mol Zn}}{65.41 \text{ g Zn}} \right) = 0.01999 \text{ mol Zn}$$

Zn is the limiting reactant.

$$-q_{\text{rxn}} = q_{\text{water}} + q_{\text{calorimeter}}$$

$$= \left[ 100.0 \text{ mL} \left( \frac{1.015 \text{ g}}{\text{mL}} \right) + 1.3078 \text{ g} \right] \left[ 3.95 \frac{\text{J}}{\text{g}^\circ\text{C}} \right] \left[ (24.1 - 16.8)^\circ\text{C} \right] \left( \frac{1 \text{ kJ}}{10^3 \text{ J}} \right) + \left( 0.01587 \frac{\text{kJ}}{^\circ\text{C}} \right) \left[ (24.1 - 16.8)^\circ\text{C} \right]$$

$$= 3.0803 \text{ kJ}$$

$$\Delta H_{\text{rxn}}^\circ = (-3.0803 \text{ kJ})/(0.01999 \text{ mol Zn}) = -154.1 = \mathbf{-1.5 \times 10^2 \text{ kJ/mol}}$$

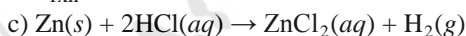

$$\Delta H_{\text{rxn}}^\circ = \{1 \Delta H_f^\circ [\text{ZnCl}_2(\text{aq})] + 1 [\Delta H_f^\circ \text{H}_2(\text{g})]\} - \{1 \Delta H_f^\circ [\text{Zn}(\text{s})] + 2 \Delta H_f^\circ [\text{HCl}(\text{aq})]\}$$

$$\Delta H_{\text{rxn}}^\circ = [(1 \text{ mol})(-4.822 \times 10^2 \text{ kJ/mol}) + (1 \text{ mol})(0.0 \text{ kJ/mol})] - [(1 \text{ mol})(0.0 \text{ kJ/mol}) + (2 \text{ mol})(-1.652 \times 10^2 \text{ kJ/mol})]$$

$$\Delta H_{\text{rxn}}^\circ = -151.8 \text{ kJ}$$

$$\text{Error} = \left| \frac{-151.8 - (-154.1)}{-151.8} \right| (100\%) = 1.515 = 2\%$$

6.81 Plan: Use  $PV = nRT$  to find the initial volume of nitrogen gas at  $0^\circ\text{C}$  and then the final volume at  $819^\circ\text{C}$ . Then the relationship  $w = -P\Delta V$  can be used to calculate the work of expansion.

**Solution:**

a)  $PV = nRT$

$$\text{Initial volume at } 0^\circ\text{C} + 273 = 273 \text{ K} = V = \frac{nRT}{P} = \frac{(1 \text{ mol}) \left( 0.0821 \frac{\text{L}\cdot\text{atm}}{\text{mol}\cdot\text{K}} \right) (273 \text{ K})}{(1.00 \text{ atm})} = 22.4133 \text{ L}$$

$$\text{Final volume at } 819^\circ\text{C} + 273 = 1092 \text{ K} = V = \frac{nRT}{P} = \frac{(1 \text{ mol}) \left( 0.0821 \frac{\text{L}\cdot\text{atm}}{\text{mol}\cdot\text{K}} \right) (1092 \text{ K})}{(1.00 \text{ atm})} = 89.6532 \text{ L}$$

$$\Delta V = V_{\text{final}} - V_{\text{initial}} = 89.6532 \text{ L} - 22.4133 \text{ L} = 67.2399 \text{ L}$$

$$w = -P\Delta V = -(1 \text{ atm}) \times 67.2399 \text{ L} = -67.2399 \text{ atm}\cdot\text{L}$$

$$w \text{ (J)} = (-67.2399 \text{ atm}\cdot\text{L}) \left( \frac{1 \text{ J}}{9.87 \times 10^{-3} \text{ atm}\cdot\text{L}} \right) = -6812.553 = \mathbf{-6.81 \times 10^3 \text{ J}}$$

b)  $q = c \times \text{mass} \times \Delta T$

$$\text{Mass (g) of } \text{N}_2 = (1 \text{ mol } \text{N}_2) \left( \frac{28.02 \text{ g}}{1 \text{ mol } \text{N}_2} \right) = 28.02 \text{ g}$$

$$\Delta T = \frac{q}{(c)(\text{mass})} = \frac{6.812553 \times 10^3 \text{ J}}{(28.02 \text{ g})(1.00 \text{ J/g}\cdot\text{K})} = 243.132 = 243 \text{ K} = \mathbf{243^\circ\text{C}}$$

- 6.82 **Plan:** Note the numbers of moles of the reactants and products in the target equation and manipulate equations 1-5 and their  $\Delta H_{\text{rxn}}^\circ$  values so that these equations sum to give the target equation. Then the manipulated  $\Delta H_{\text{rxn}}^\circ$  values will add to give the  $\Delta H_{\text{rxn}}^\circ$  value of the target equation.

**Solution:**

Only reaction 3 contains  $\text{N}_2\text{O}_4(\text{g})$ , and only reaction 1 contains  $\text{N}_2\text{O}_3(\text{g})$ , so we can use those reactions as a starting point.  $\text{N}_2\text{O}_5$  appears in both reactions 2 and 5, but note the physical states present: solid and gas. As a rough start, adding reactions 1, 3, and 5 yields the desired reactants and products, with some undesired intermediates:

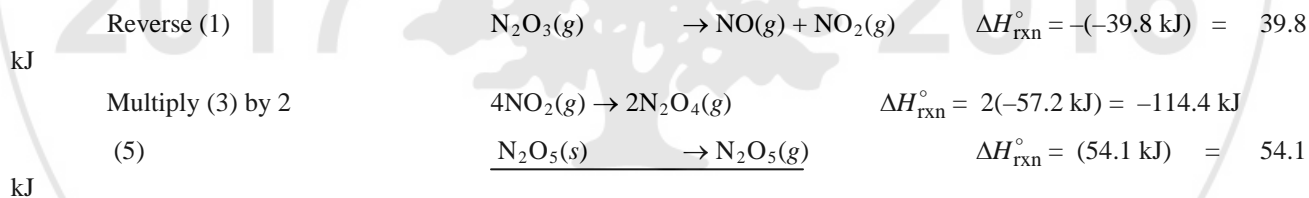

To cancel out the  $\text{N}_2\text{O}_5(\text{g})$  intermediate, reverse equation 2. This also cancels out some of the undesired  $\text{NO}_2(\text{g})$  but adds  $\text{NO}(\text{g})$  and  $\text{O}_2(\text{g})$ . Finally, add equation 4 to remove those intermediates:

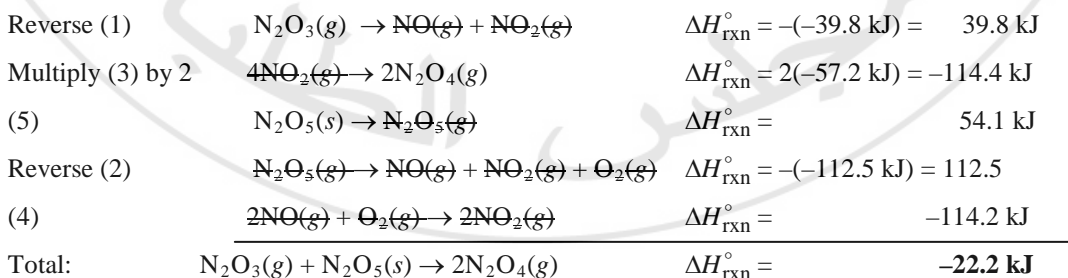

- 6.83  $\text{CO}(\text{g}) + 2\text{H}_2(\text{g}) \rightarrow \text{CH}_3\text{OH}(\text{l})$

$$\begin{aligned} \Delta H_{\text{rxn}}^\circ &= \{1 \Delta H_f^\circ [\text{CH}_3\text{OH}(\text{l})]\} - \{1 \Delta H_f^\circ [\text{CO}(\text{g})] + 2 \Delta H_f^\circ [\text{H}_2(\text{g})]\} \\ &= [(1 \text{ mol})(-238.6 \text{ kJ/mol})] - [(1 \text{ mol})(-110.5 \text{ kJ/mol}) + (2 \text{ mol})(0.0 \text{ kJ/mol})] \\ &= -128.1 \text{ kJ} \end{aligned}$$

Find the limiting reactant:

$$\text{Moles of CO} = \frac{PV}{RT} = \frac{(112 \text{ kPa})(15.0 \text{ L})}{\left(0.0821 \frac{\text{L}\cdot\text{atm}}{\text{mol}\cdot\text{K}}\right)((273 + 85) \text{ K})} \left(\frac{1 \text{ atm}}{101.325 \text{ kPa}}\right) = 0.5641135 \text{ mol CO}$$

$$\text{Moles of CH}_3\text{OH from CO} = (0.5641135 \text{ mol CO}) \left(\frac{1 \text{ mol CH}_3\text{OH}}{1 \text{ mol CO}}\right) = 0.5641135 \text{ mol CH}_3\text{OH}$$

$$\text{Moles of H}_2 = \frac{PV}{RT} = \frac{(744 \text{ torr})(18.5 \text{ L})}{\left(0.0821 \frac{\text{L}\cdot\text{atm}}{\text{mol}\cdot\text{K}}\right)((273 + 75) \text{ K})} \left(\frac{1 \text{ atm}}{760 \text{ torr}}\right) = 0.6338824 \text{ mol H}_2$$

$$\text{Moles of CH}_3\text{OH from H}_2 = (0.6338824 \text{ mol H}_2) \left(\frac{1 \text{ mol CH}_3\text{OH}}{2 \text{ mol H}_2}\right) = 0.3169412 \text{ mol CH}_3\text{OH}$$

H<sub>2</sub> is limiting.

$$\text{Heat (kJ)} = (0.6338824 \text{ mol H}_2) \left(\frac{-128.1 \text{ kJ}}{2 \text{ mol H}_2}\right) = -40.6002 = \mathbf{-40.6 \text{ kJ}}$$

- 6.84 Plan: First find the heat of reaction for the combustion of methane. The enthalpy change of a reaction is the sum of the heats of formation of the products minus the sum of the heats of formation of the reactants. Since the  $\Delta H_f^\circ$  values (Appendix B) are reported as energy per one mole, use the appropriate stoichiometric coefficient to reflect the higher number of moles. Convert the mass of methane to moles and multiply that mole number by the heat of combustion.

Solution:

a) The balanced chemical equation for this reaction is:

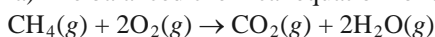

$$\begin{aligned} \Delta H_{\text{rxn}}^\circ &= \{1 \Delta H_f^\circ [\text{CO}_2(\text{g})] + 2 \Delta H_f^\circ [\text{H}_2\text{O}(\text{g})]\} - \{1 \Delta H_f^\circ [\text{CH}_4(\text{g})] + 2 \Delta H_f^\circ [\text{O}_2(\text{g})]\} \\ &= [(1 \text{ mol})(-393.5 \text{ kJ/mol}) + (2 \text{ mol})(-241.826 \text{ kJ/mol})] - [(1 \text{ mol})(-74.87 \text{ kJ/mol}) + (2 \text{ mol})(0.0 \text{ kJ/mol})] \\ &= -802.282 \text{ kJ} \end{aligned}$$

$$\text{Moles of CH}_4 = (25.0 \text{ g CH}_4) \left(\frac{1 \text{ mol}}{16.04 \text{ g CH}_4}\right) = 1.5586 \text{ mol CH}_4$$

$$\text{Heat (kJ)} = (1.5586 \text{ mol CH}_4) \left(\frac{-802.282 \text{ kJ}}{1 \text{ mol CH}_4}\right) = -1250.4 = \mathbf{-1.25 \times 10^3 \text{ kJ}}$$

b) The heat released by the reaction is “stored” in the gaseous molecules by virtue of their specific heat capacities,  $c$ , using the equation  $q = c \times \text{mass} \times \Delta T$ . The problem specifies heat capacities on a molar basis, so we modify the equation to use moles, instead of mass. The gases that remain at the end of the reaction are CO<sub>2</sub> and H<sub>2</sub>O. All of the methane and oxygen molecules were consumed. However, the oxygen was added as a component of air, which is 78% N<sub>2</sub> and 21% O<sub>2</sub>, and there is leftover N<sub>2</sub>.

$$\text{Moles of CO}_2(\text{g}) = (1.5586 \text{ mol CH}_4) \left(\frac{1 \text{ mol CO}_2}{1 \text{ mol CH}_4}\right) = 1.5586 \text{ mol CO}_2(\text{g})$$

$$\text{Moles of H}_2\text{O}(\text{g}) = (1.5586 \text{ mol CH}_4) \left(\frac{2 \text{ mol H}_2\text{O}}{1 \text{ mol CH}_4}\right) = 3.1172 \text{ mol H}_2\text{O}(\text{g})$$

$$\text{Moles of O}_2(\text{g}) \text{ reacted} = (1.5586 \text{ mol CH}_4) \left(\frac{2 \text{ mol O}_2}{1 \text{ mol CH}_4}\right) = 3.1172 \text{ mol O}_2(\text{g})$$

$$\text{Mole fraction N}_2 = (79\%/100\%) = 0.79$$

$$\text{Mole fraction O}_2 = (21\%/100\%) = 0.21$$

$$\text{Moles of N}_2(\text{g}) = (3.1172 \text{ mol O}_2 \text{ reacted}) \left(\frac{0.79 \text{ mol N}_2}{0.21 \text{ mol O}_2}\right) = 11.72661 \text{ mol N}_2$$

$$q = c \times \text{mass} \times \Delta T$$

$$q = (1250.4 \text{ kJ}) \left( \frac{10^3 \text{ J}}{1 \text{ kJ}} \right) = 1.2504 \times 10^6 \text{ J}$$

$$1.2504 \times 10^6 \text{ J} = (1.5586 \text{ mol CO}_2)(57.2 \text{ J/mol}^\circ\text{C})(T_{\text{final}} - 0.0)^\circ\text{C} \\ + (3.1172 \text{ mol H}_2\text{O})(36.0 \text{ J/mol}^\circ\text{C})(T_{\text{final}} - 0.0)^\circ\text{C} \\ + (11.72661 \text{ mol N}_2)(30.5 \text{ J/mol}^\circ\text{C})(T_{\text{final}} - 0.0)^\circ\text{C}$$

$$1.2504 \times 10^6 \text{ J} = 89.15192 \text{ J/}^\circ\text{C}(T_{\text{final}}) + 112.2192 \text{ J/}^\circ\text{C}(T_{\text{final}}) + 357.6616 \text{ J/}^\circ\text{C}(T_{\text{final}})$$

$$1.2504 \times 10^6 \text{ J} = (559.03272 \text{ J/}^\circ\text{C})T_{\text{final}}$$

$$T_{\text{final}} = (1.2504 \times 10^6 \text{ J}) / (559.0324 \text{ J/}^\circ\text{C}) = 2236.72 = \mathbf{2.24 \times 10^3}^\circ\text{C}$$

جَامِعَةُ بِيْرزَيْتِ  
BIRZEIT UNIVERSITY

2017



2016

مجلس الطلبة

# CHAPTER 7 QUANTUM THEORY AND ATOMIC STRUCTURE

---

The value for the speed of light will be  $3.00 \times 10^8$  m/s except when more significant figures are necessary, in which cases,  $2.9979 \times 10^8$  m/s will be used.

## END-OF-CHAPTER PROBLEMS

- 7.1 All types of electromagnetic radiation travel as waves at the same speed. They differ in both their frequency, wavelength, and energy.
- 7.2 **Plan:** Recall that the shorter the wavelength, the higher the frequency and the greater the energy. Figure 7.3 describes the electromagnetic spectrum by wavelength and frequency.
- Solution:**
- a) Wavelength increases from left ( $10^{-2}$  nm) to right ( $10^{12}$  nm) in Figure 7.3. The trend in increasing wavelength is: **x-ray < ultraviolet < visible < infrared < microwave < radio wave.**
- b) Frequency is inversely proportional to wavelength according to the equation  $c = \lambda\nu$ , so frequency has the opposite trend: **radio wave < microwave < infrared < visible < ultraviolet < x-ray.**
- c) Energy is directly proportional to frequency according to the equation  $E = h\nu$ . Therefore, the trend in increasing energy matches the trend in increasing frequency: **radio wave < microwave < infrared < visible < ultraviolet < x-ray.**
- 7.3 Evidence for the wave model is seen in the phenomena of diffraction and refraction. Evidence for the particle model includes the photoelectric effect and blackbody radiation.
- 7.4 In order to explain the formula he developed for the energy vs. wavelength data of blackbody radiation, Max Planck assumed that only certain quantities of energy, called quanta, could be emitted or absorbed. The magnitude of these gains and losses were whole number multiples of the frequency:  $\Delta E = nh\nu$ .
- 7.5
- a) Frequency: **C < B < A**
- b) Energy: **C < B < A**
- c) Amplitude: **B < C < A**
- d) Since wave A has a higher energy and frequency than B, wave **A** is more likely to cause a current.
- e) Wave **C** is more likely to be infrared radiation since wave C has a longer wavelength than B.
- 7.6 Radiation (light energy) occurs as quanta of electromagnetic radiation, where each packet of energy is called a photon. The energy associated with this photon is fixed by its frequency,  $E = h\nu$ . Since energy depends on frequency, a threshold (minimum) frequency is to be expected. A current will flow as soon as a photon of sufficient energy reaches the metal plate, so there is no time lag.
- 7.7 **Plan:** Wavelength is related to frequency through the equation  $c = \lambda\nu$ . Recall that a Hz is a reciprocal second, or  $1/s = s^{-1}$ . Assume that the number “950” has three significant figures.

**Solution:**

$$c = \lambda\nu$$

$$\lambda \text{ (m)} = \frac{c}{\nu} = \frac{3.00 \times 10^8 \text{ m/s}}{(950. \text{ kHz}) \left( \frac{10^3 \text{ Hz}}{1 \text{ kHz}} \right) \left( \frac{s^{-1}}{\text{Hz}} \right)} = 315.789 = \mathbf{316 \text{ m}}$$

$$\lambda \text{ (nm)} = \frac{c}{\nu} = (315.789 \text{ m}) \left( \frac{1 \text{ nm}}{10^{-9} \text{ m}} \right) = 3.15789 \times 10^{11} = \mathbf{3.16 \times 10^{11} \text{ nm}}$$

$$\lambda (\text{\AA}) = \frac{c}{\nu} = (315.789 \text{ m}) \left( \frac{1 \text{\AA}}{10^{-10} \text{ m}} \right) = 3.158 \times 10^{12} = \mathbf{3.16 \times 10^{12} \text{\AA}}$$

- 7.8 Wavelength and frequency relate through the equation  $c = \lambda \nu$ . Recall that a Hz is a reciprocal second, or  $1/\text{s} = \text{s}^{-1}$ .

$$\lambda (\text{m}) = \frac{c}{\nu} = \frac{3.00 \times 10^8 \text{ m/s}}{(93.5 \text{ MHz}) \left( \frac{10^6 \text{ Hz}}{1 \text{ MHz}} \right) \left( \frac{\text{s}^{-1}}{\text{Hz}} \right)} = 3.208556 = \mathbf{3.21 \text{ m}}$$

$$\lambda (\text{nm}) = \frac{c}{\nu} = (3.208556 \text{ m}) \left( \frac{1 \text{ nm}}{10^{-9} \text{ m}} \right) = 3.208556 \times 10^9 = \mathbf{3.21 \times 10^9 \text{ nm}}$$

$$\lambda (\text{\AA}) = \frac{c}{\nu} = (3.208556 \text{ m}) \left( \frac{1 \text{\AA}}{10^{-10} \text{ m}} \right) = 3.208556 \times 10^{10} = \mathbf{3.21 \times 10^{10} \text{\AA}}$$

- 7.9 Plan: Frequency is related to energy through the equation  $E = h \nu$ . Note that  $1 \text{ Hz} = 1 \text{ s}^{-1}$ .

Solution:

$$E = h \nu$$

$$E = (6.626 \times 10^{-34} \text{ J}\cdot\text{s})(3.8 \times 10^{10} \text{ s}^{-1}) = 2.51788 \times 10^{-23} = \mathbf{2.5 \times 10^{-23} \text{ J}}$$

7.10 
$$E = \frac{hc}{\lambda} = \frac{(6.626 \times 10^{-34} \text{ J}\cdot\text{s})(3.00 \times 10^8 \text{ m/s})}{1.3 \text{\AA}} \left( \frac{1 \text{\AA}}{10^{-10} \text{ m}} \right) = 1.5291 \times 10^{-15} = \mathbf{1.5 \times 10^{-15} \text{ J}}$$

- 7.11 Plan: Energy is inversely proportional to wavelength ( $E = \frac{hc}{\lambda}$ ). As wavelength decreases, energy increases.

Solution:

In terms of increasing energy the order is **red < yellow < blue**.

- 7.12 Since energy is directly proportional to frequency ( $E = h \nu$ ): UV ( $\nu = 8.0 \times 10^{15} \text{ s}^{-1}$ ) > IR ( $\nu = 6.5 \times 10^{13} \text{ s}^{-1}$ ) > microwave ( $\nu = 9.8 \times 10^{11} \text{ s}^{-1}$ ) or **UV > IR > microwave**.

- 7.13 Frequency and energy are related by  $E = h \nu$ , and wavelength and energy are related by  $E = hc/\lambda$ .

$$\nu (\text{Hz}) = \frac{E}{h} = \frac{(1.33 \text{ MeV}) \left( \frac{10^6 \text{ eV}}{1 \text{ MeV}} \right) \left( \frac{1.602 \times 10^{-19} \text{ J}}{1 \text{ eV}} \right)}{6.626 \times 10^{-34} \text{ J}\cdot\text{s}} \left( \frac{\text{Hz}}{\text{s}^{-1}} \right) = 3.2156 \times 10^{20} = \mathbf{3.22 \times 10^{20} \text{ Hz}}$$

$$\lambda (\text{m}) = \frac{hc}{E} = \frac{(6.626 \times 10^{-34} \text{ J}\cdot\text{s})(3.00 \times 10^8 \text{ m/s})}{(1.33 \text{ MeV}) \left( \frac{10^6 \text{ eV}}{1 \text{ MeV}} \right) \left( \frac{1.602 \times 10^{-19} \text{ J}}{1 \text{ eV}} \right)} = 9.32950 \times 10^{-13} = \mathbf{9.33 \times 10^{-13} \text{ m}}$$

The wavelength can also be found using the frequency calculated in the equation  $c = \lambda \nu$ .

- 7.14 Plan: The least energetic photon in part a) has the longest wavelength (242 nm). The most energetic photon in part b) has the shortest wavelength (2200 \AA). Use the relationship  $c = \lambda \nu$  to find the frequency of the photons and relationship  $E = \frac{hc}{\lambda}$  to find the energy.

Solution:

a)  $c = \lambda \nu$

$$\nu = \frac{c}{\lambda} = \frac{3.00 \times 10^8 \text{ m/s}}{242 \text{ nm}} \left( \frac{1 \text{ nm}}{10^{-9} \text{ m}} \right) = 1.239669 \times 10^{15} = \mathbf{1.24 \times 10^{15} \text{ s}^{-1}}$$

$$E = \frac{hc}{\lambda} = \frac{(6.626 \times 10^{-34} \text{ J}\cdot\text{s})(3.00 \times 10^8 \text{ m/s})}{242 \text{ nm}} \left( \frac{1 \text{ nm}}{10^{-9} \text{ m}} \right) = 8.2140 \times 10^{-19} = \mathbf{8.21 \times 10^{-19} \text{ J}}$$

$$\text{b) } \nu = \frac{c}{\lambda} = \frac{3.00 \times 10^8 \text{ m/s}}{2200 \text{ \AA}} \left( \frac{1 \text{ \AA}}{10^{-10} \text{ m}} \right) = 1.3636 \times 10^{15} = \mathbf{1.4 \times 10^{15} \text{ s}^{-1}}$$

$$E = \frac{hc}{\lambda} = \frac{(6.626 \times 10^{-34} \text{ J}\cdot\text{s})(3.00 \times 10^8 \text{ m/s})}{2200 \text{ \AA}} \left( \frac{1 \text{ \AA}}{10^{-10} \text{ m}} \right) = 9.03545 \times 10^{-19} = \mathbf{9.0 \times 10^{-19} \text{ J}}$$

7.15 “ $n$ ” in the Rydberg equation is equal to a Bohr orbit of quantum number “ $n$ ” where  $n = 1, 2, 3, \dots \infty$ .

7.16 An absorption spectrum is produced when atoms absorb certain wavelengths of incoming light as electrons move from lower to higher energy levels and results in dark lines against a bright background. An emission spectrum is produced when atoms that have been excited to higher energy emit photons as their electrons return to lower energy levels and results in colored lines against a dark background. Bohr worked with emission spectra.

7.17 Plan: The quantum number  $n$  is related to the energy level of the electron. An electron *absorbs* energy to change from lower energy (lower  $n$ ) to higher energy (higher  $n$ ), giving an absorption spectrum. An electron *emits* energy as it drops from a higher energy level (higher  $n$ ) to a lower one (lower  $n$ ), giving an emission spectrum.

Solution:

a) The electron is moving from a lower value of  $n$  (2) to a higher value of  $n$  (4): **absorption**

b) The electron is moving from a higher value of  $n$  (3) to a lower value of  $n$  (1): **emission**

c) The electron is moving from a higher value of  $n$  (5) to a lower value of  $n$  (2): **emission**

d) The electron is moving from a lower value of  $n$  (3) to a higher value of  $n$  (4): **absorption**

7.18 The Bohr model works only for a one-electron system. The additional attractions and repulsions in many-electron systems make it impossible to predict accurately the spectral lines.

7.19 Plan: Calculate wavelength by substituting the given values into Equation 7.3, where  $n_1 = 2$  and  $n_2 = 5$  because  $n_2 > n_1$ . Although more significant figures could be used, five significant figures are adequate for this calculation.

Solution:

$$\frac{1}{\lambda} = R \left( \frac{1}{n_1^2} - \frac{1}{n_2^2} \right) \quad R = 1.096776 \times 10^7 \text{ m}^{-1}$$

$$n_1 = 2 \quad n_2 = 5$$

$$\frac{1}{\lambda} = R \left( \frac{1}{n_1^2} - \frac{1}{n_2^2} \right) = (1.096776 \times 10^7 \text{ m}^{-1}) \left( \frac{1}{2^2} - \frac{1}{5^2} \right) = 2,303,229.6 \text{ m}^{-1}$$

$$\lambda (\text{nm}) = \left( \frac{1}{2,303,229.6 \text{ m}^{-1}} \right) \left( \frac{1 \text{ nm}}{10^{-9} \text{ m}} \right) = 434.1729544 = \mathbf{434.17 \text{ nm}}$$

7.20 Calculate wavelength by substituting the given values into the Rydberg equation, where  $n_1 = 1$  and  $n_2 = 3$  because  $n_2 > n_1$ . Although more significant figures could be used, five significant figures are adequate for this calculation.

$$\frac{1}{\lambda} = R \left( \frac{1}{n_1^2} - \frac{1}{n_2^2} \right) = (1.096776 \times 10^7 \text{ m}^{-1}) \left( \frac{1}{1^2} - \frac{1}{3^2} \right) = 9,749,120 \text{ m}^{-1}$$

$$\lambda (\text{\AA}) = \left( \frac{1}{9,749,120 \text{ m}^{-1}} \right) \left( \frac{1 \text{ \AA}}{10^{-10} \text{ m}} \right) = 1025.7336 = \mathbf{1025.7 \text{ \AA}}$$



- 7.21 Plan: To find the transition energy, use the equation for the energy of an electron transition and multiply by Avogadro's number to convert to energy per mole.

Solution:

$$\Delta E = (-2.18 \times 10^{-18} \text{ J}) \left( \frac{1}{n_{\text{final}}^2} - \frac{1}{n_{\text{initial}}^2} \right)$$

$$\Delta E = (-2.18 \times 10^{-18} \text{ J}) \left( \frac{1}{2^2} - \frac{1}{5^2} \right) = -4.578 \times 10^{-19} \text{ J/photon}$$

$$\Delta E = \left( \frac{-4.578 \times 10^{-19} \text{ J}}{\text{photon}} \right) \left( \frac{6.022 \times 10^{23} \text{ photons}}{1 \text{ mol}} \right) = -2.75687 \times 10^5 = \mathbf{-2.76 \times 10^5 \text{ J/mol}}$$

The energy has a negative value since this electron transition to a lower  $n$  value is an emission of energy.

- 7.22 To find the transition energy, use the equation for the energy of an electron transition and multiply by Avogadro's number.

$$\Delta E = (-2.18 \times 10^{-18} \text{ J}) \left( \frac{1}{n_{\text{final}}^2} - \frac{1}{n_{\text{initial}}^2} \right)$$

$$\Delta E = (-2.18 \times 10^{-18} \text{ J}) \left( \frac{1}{3^2} - \frac{1}{1^2} \right) = 1.93778 \times 10^{-18} \text{ J/photon}$$

$$\Delta E = \left( \frac{1.93778 \times 10^{-18} \text{ J}}{\text{photon}} \right) \left( \frac{6.022 \times 10^{23} \text{ photons}}{1 \text{ mol}} \right) = 1.1669 \times 10^6 = \mathbf{1.17 \times 10^6 \text{ J/mol}}$$

- 7.23 Plan: Determine the relative energy of the electron transitions. Remember that energy is directly proportional to frequency ( $E = h\nu$ ).

Solution:

Looking at an energy chart will help answer this question.

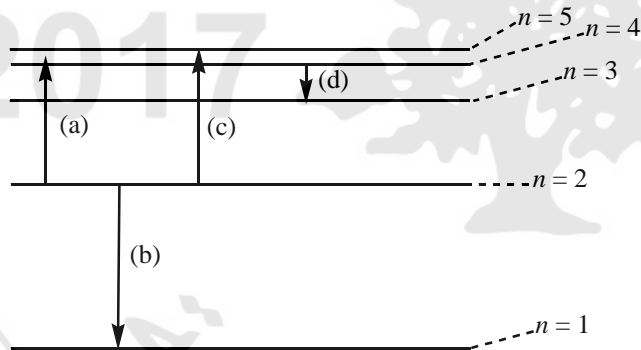

Frequency is proportional to energy so the smallest frequency will be d)  $n = 4$  to  $n = 3$ ; levels 3 and 4 have a smaller  $\Delta E$  than the levels in the other transitions. The largest frequency is b)  $n = 2$  to  $n = 1$  since levels 1 and 2 have a larger  $\Delta E$  than the levels in the other transitions. Transition a)  $n = 2$  to  $n = 4$  will be smaller than transition c)  $n = 2$  to  $n = 5$  since level 5 is a higher energy than level 4. In order of increasing frequency the transitions are  $\mathbf{d < a < c < b}$ .

- 7.24  $\mathbf{b > c > a > d}$

- 7.25 Plan: Use the Rydberg equation. Since the electron is in the ground state (lowest energy level),  $n_1 = 1$ . Convert the wavelength from nm to units of meters.

**Solution:**

$$\lambda = (97.20 \text{ nm}) \left( \frac{10^{-9} \text{ m}}{1 \text{ nm}} \right) = 9.720 \times 10^{-8} \text{ m} \quad \text{ground state: } n_1 = 1; \quad n_2 = ?$$

$$\frac{1}{\lambda} = (1.096776 \times 10^7 \text{ m}^{-1}) \left( \frac{1}{n_1^2} - \frac{1}{n_2^2} \right)$$

$$\frac{1}{9.72 \times 10^{-8} \text{ m}} = (1.096776 \times 10^7 \text{ m}^{-1}) \left( \frac{1}{1^2} - \frac{1}{n_2^2} \right)$$

$$0.93803 = \left( \frac{1}{1^2} - \frac{1}{n_2^2} \right)$$

$$\frac{1}{n_2^2} = 1 - 0.93803 = 0.06197$$

$$n_2^2 = 16.14$$

$$n_2 = 4$$

$$7.26 \quad \lambda = (1281 \text{ nm}) \left( \frac{10^{-9} \text{ m}}{1 \text{ nm}} \right) = 1.281 \times 10^{-6} \text{ m}$$

$$\frac{1}{\lambda} = (1.096776 \times 10^7 \text{ m}^{-1}) \left( \frac{1}{n_1^2} - \frac{1}{n_2^2} \right)$$

$$\frac{1}{1.281 \times 10^{-6} \text{ m}} = (1.096776 \times 10^7 \text{ m}^{-1}) \left( \frac{1}{n_1^2} - \frac{1}{5^2} \right)$$

$$0.07118 = \left( \frac{1}{n_1^2} - \frac{1}{5^2} \right)$$

$$\frac{1}{n_1^2} = 0.07118 + 0.04000 = 0.11118$$

$$n_1^2 = 8.9944$$

$$n_1 = 3$$

$$7.27 \quad E = \frac{hc}{\lambda} = \frac{(6.626 \times 10^{-34} \text{ J}\cdot\text{s})(3.00 \times 10^8 \text{ m/s})}{(436 \text{ nm})} \left( \frac{1 \text{ nm}}{10^{-9} \text{ m}} \right) = 4.55917 \times 10^{-19} = \mathbf{4.56 \times 10^{-19} \text{ J}}$$

7.28 a) Absorptions: **A, C, D**; Emissions: **B, E, F**

b) Energy of emissions: **E < F < B**

c) Wavelength of absorption: **D < A < C**

7.29 Macroscopic objects have significant mass. A large  $m$  in the denominator of  $\lambda = h/mu$  will result in a very small wavelength. Macroscopic objects do exhibit a wavelike motion, but the wavelength is too small for humans to see it.

7.30 The Heisenberg uncertainty principle states that there is fundamental limit to the accuracy of measurements. This limit is not dependent on the precision of the measuring instruments, but is inherent in nature.

7.31 Plan: Use the de Broglie equation. Mass in lb must be converted to kg and velocity in mi/h must be converted to m/s because a joule is equivalent to  $\text{kg}\cdot\text{m}^2/\text{s}^2$ .

Solution:

$$\text{a) Mass (kg)} = (232 \text{ lb}) \left( \frac{1 \text{ kg}}{2.205 \text{ lb}} \right) = 105.2154 \text{ kg}$$

$$\text{Velocity (m/s)} = \left( \frac{19.8 \text{ mi}}{\text{h}} \right) \left( \frac{1 \text{ km}}{0.62 \text{ mi}} \right) \left( \frac{10^3 \text{ m}}{1 \text{ km}} \right) \left( \frac{1 \text{ h}}{3600 \text{ s}} \right) = 8.87097 \text{ m/s}$$

$$\lambda = \frac{h}{mu} = \frac{(6.626 \times 10^{-34} \text{ J}\cdot\text{s})}{(105.2154 \text{ kg}) \left( 8.87097 \frac{\text{m}}{\text{s}} \right)} \left( \frac{\text{kg}\cdot\text{m}^2/\text{s}^2}{\text{J}} \right) = 7.099063 \times 10^{-37} = \mathbf{7.10 \times 10^{-37} \text{ m}}$$

$$\text{b) Uncertainty in velocity (m/s)} = \left( \frac{0.1 \text{ mi}}{\text{h}} \right) \left( \frac{1 \text{ km}}{0.62 \text{ mi}} \right) \left( \frac{10^3 \text{ m}}{1 \text{ km}} \right) \left( \frac{1 \text{ h}}{3600 \text{ s}} \right) = 0.0448029 \text{ m/s}$$

$$\Delta x \cdot m \Delta v \geq \frac{h}{4\pi}$$

$$\Delta x \geq \frac{h}{4\pi m \Delta v} \geq \frac{(6.626 \times 10^{-34} \text{ J}\cdot\text{s})}{4\pi (105.2154 \text{ kg}) \left( \frac{0.0448029 \text{ m}}{\text{s}} \right)} \left( \frac{\text{kg}\cdot\text{m}^2/\text{s}^2}{\text{J}} \right) \geq 1.11855 \times 10^{-35} \geq \mathbf{1 \times 10^{-35} \text{ m}}$$

$$7.32 \quad \text{a) } \lambda = \frac{h}{mu} = \frac{(6.626 \times 10^{-34} \text{ J}\cdot\text{s})}{(6.6 \times 10^{-24} \text{ g}) \left( 3.4 \times 10^7 \frac{\text{mi}}{\text{h}} \right)} \left( \frac{\text{kg}\cdot\text{m}^2/\text{s}^2}{\text{J}} \right) \left( \frac{10^3 \text{ g}}{1 \text{ kg}} \right) \left( \frac{0.62 \text{ mi}}{1 \text{ km}} \right) \left( \frac{1 \text{ km}}{10^3 \text{ m}} \right) \left( \frac{3600 \text{ s}}{1 \text{ h}} \right)$$
$$= 6.59057 \times 10^{-15} = \mathbf{6.6 \times 10^{-15} \text{ m}}$$

$$\text{b) } \Delta x \cdot m \Delta v \geq \frac{h}{4\pi}$$

$$\Delta x \geq \frac{h}{4\pi m \Delta v} \geq \frac{(6.626 \times 10^{-34} \text{ J}\cdot\text{s})}{4\pi (6.6 \times 10^{-24} \text{ g}) \left( \frac{0.1 \times 10^7 \text{ mi}}{\text{h}} \right)} \left( \frac{\text{kg}\cdot\text{m}^2/\text{s}^2}{\text{J}} \right) \left( \frac{10^3 \text{ g}}{1 \text{ kg}} \right) \left( \frac{0.62 \text{ mi}}{1 \text{ km}} \right) \left( \frac{1 \text{ km}}{10^3 \text{ m}} \right) \left( \frac{3600 \text{ s}}{1 \text{ h}} \right)$$
$$\geq 1.783166 \times 10^{-14} \geq \mathbf{2 \times 10^{-14} \text{ m}}$$

7.33 Plan: Use the de Broglie equation. Mass in g must be converted to kg and wavelength in Å must be converted to m because a joule is equivalent to  $\text{kg}\cdot\text{m}^2/\text{s}^2$ .

Solution:

$$\text{Mass (kg)} = (56.5 \text{ g}) \left( \frac{1 \text{ kg}}{10^3 \text{ g}} \right) = 0.0565 \text{ kg}$$

$$\text{Wavelength (m)} = (5400 \text{ Å}) \left( \frac{10^{-10} \text{ m}}{1 \text{ Å}} \right) = 5.4 \times 10^{-7} \text{ m}$$

$$\lambda = \frac{h}{mu}$$

$$u = \frac{h}{m\lambda} = \frac{(6.626 \times 10^{-34} \text{ J}\cdot\text{s})}{(0.0565 \text{ kg}) (5.4 \times 10^{-7} \text{ m})} \left( \frac{\text{kg}\cdot\text{m}^2/\text{s}^2}{\text{J}} \right) = 2.1717 \times 10^{-26} = \mathbf{2.2 \times 10^{-26} \text{ m/s}}$$

$$7.34 \quad \lambda = \frac{h}{mu}$$

$$u = \frac{h}{m\lambda} = \frac{(6.626 \times 10^{-34} \text{ J}\cdot\text{s})}{(142 \text{ g})(100. \text{ pm})} \left( \frac{\text{kg}\cdot\text{m}^2/\text{s}^2}{\text{J}} \right) \left( \frac{10^3 \text{ g}}{1 \text{ kg}} \right) \left( \frac{1 \text{ pm}}{10^{-12} \text{ m}} \right) = 4.666197 \times 10^{-23} = \mathbf{4.67 \times 10^{-23} \text{ m/s}}$$

- 7.35 Plan: The de Broglie wavelength equation will give the mass equivalent of a photon with known wavelength and velocity. The term “mass equivalent” is used instead of “mass of photon” because photons are quanta of electromagnetic energy that have no mass. A light photon’s velocity is the speed of light,  $3.00 \times 10^8 \text{ m/s}$ . Wavelength in nm must be converted to m.

Solution:

$$\text{Wavelength (m)} = (589 \text{ nm}) \left( \frac{10^{-9} \text{ m}}{1 \text{ nm}} \right) = 5.89 \times 10^{-7} \text{ m}$$

$$\lambda = \frac{h}{mu}$$

$$m = \frac{h}{\lambda u} = \frac{(6.626 \times 10^{-34} \text{ J}\cdot\text{s})}{(5.89 \times 10^{-7} \text{ m})(3.00 \times 10^8 \text{ m/s})} \left( \frac{\text{kg}\cdot\text{m}^2/\text{s}^2}{\text{J}} \right) = 3.7499 \times 10^{-36} = \mathbf{3.75 \times 10^{-36} \text{ kg/photon}}$$

$$7.36 \quad \lambda = \frac{h}{mu}$$

$$m = \frac{h}{\lambda u} = \frac{(6.626 \times 10^{-34} \text{ J}\cdot\text{s})}{(671 \text{ nm})(3.00 \times 10^8 \text{ m/s})} \left( \frac{\text{kg}\cdot\text{m}^2/\text{s}^2}{\text{J}} \right) \left( \frac{1 \text{ nm}}{10^{-9} \text{ m}} \right) = 3.2916 \times 10^{-36} \text{ kg/photon}$$

$$\left( \frac{3.2916 \times 10^{-36} \text{ kg}}{\text{photon}} \right) \left( \frac{6.022 \times 10^{23} \text{ photons}}{\text{mol}} \right) = 1.9822 \times 10^{-12} = \mathbf{1.98 \times 10^{-12} \text{ kg/mol}}$$

- 7.37 The quantity  $\psi^2$  expresses the probability of finding an electron within a specified tiny region of space.
- 7.38 Since  $\psi^2$  is the probability of finding an electron within a small region or volume, electron density would represent a probability per unit volume and would more accurately be called electron probability density.
- 7.39 a) Principal quantum number,  $n$ , relates to the size of the orbital. More specifically, it relates to the distance from the nucleus at which the probability of finding an electron is greatest. This distance is determined by the energy of the electron.  
 b) Angular momentum quantum number,  $l$ , relates to the shape of the orbital. It is also called the azimuthal quantum number.  
 c) Magnetic quantum number,  $m_l$ , relates to the orientation of the orbital in space in three-dimensional space.

- 7.40 Plan: The following letter designations correlate with the following  $l$  quantum numbers:  
 $l = 0 = s$  orbital;  $l = 1 = p$  orbital;  $l = 2 = d$  orbital;  $l = 3 = f$  orbital. Remember that allowed  $m_l$  values are  $-l$  to  $+l$ .

The number of orbitals of a particular type is given by the number of possible  $m_l$  values.

Solution:

- a) There is only a single  $s$  orbital in any shell.  $l = 0$  and  $m_l = 0$ : one value of  $m_l = \mathbf{one}$   $s$  orbital.  
 b) There are five  $d$  orbitals in any shell.  $l = 2$  and  $m_l = -2, -1, 0, +1, +2$ . Five values of  $m_l = \mathbf{five}$   $d$  orbitals.  
 c) There are three  $p$  orbitals in any shell.  $l = 1$  and  $m_l = -1, 0, +1$ . Three values of  $m_l = \mathbf{three}$   $p$  orbitals.  
 d) If  $n = 3$ ,  $l = 0(s)$ ,  $1(p)$ , and  $2(d)$ . There is a  $3s$  (1 orbital), a  $3p$  set (3 orbitals), and a  $3d$  set (5 orbitals) for a total of **nine** orbitals ( $1 + 3 + 5 = 9$ ).

- 7.41 a) All *f* orbitals consist of sets of **seven** ( $l = 3$  and  $m_l = -3, -2, -1, 0, +1, +2, +3$ ).  
 b) All *p* orbitals consist of sets of **three** ( $l = 1$  and  $m_l = -1, 0, +1$ ).  
 c) All *d* orbitals consist of sets of **five** ( $l = 2$  and  $m_l = -2, -1, 0, +1, +2$ ).  
 d) If  $n = 2$ , then there is a  $2s$  (1 orbital) and a  $2p$  set (3 orbitals) for a total of **four** orbitals ( $1 + 3 = 4$ ).

7.42 Plan: Magnetic quantum numbers ( $m_l$ ) can have integer values from  $-l$  to  $+l$ . The  $l$  quantum number can have integer values from 0 to  $n - 1$ .

Solution:

- a)  $l = 2$  so  $m_l = -2, -1, 0, +1, +2$   
 b)  $n = 1$  so  $l = 1 - 1 = 0$  and  $m_l = 0$   
 c)  $l = 3$  so  $m_l = -3, -2, -1, 0, +1, +2, +3$

7.43 Magnetic quantum numbers can have integer values from  $-l$  to  $+l$ . The  $l$  quantum number can have integer values from 0 to  $n - 1$ .

- a)  $l = 3$  so  $m_l = -3, -2, -1, 0, +1, +2, +3$   
 b)  $n = 2$  so  $l = 0$  or 1; for  $l = 0$ ,  $m_l = 0$ ; for  $l = 1$ ,  $m_l = -1, 0, +1$   
 c)  $l = 1$  so  $m_l = -1, 0, +1$

7.44 Plan: The following letter designations for the various sublevels (orbitals) correlate with the following  $l$  quantum numbers:  $l = 0 = s$  orbital;  $l = 1 = p$  orbital;  $l = 2 = d$  orbital;  $l = 3 = f$  orbital. Remember that allowed  $m_l$  values are  $-l$  to  $+l$ . The number of orbitals of a particular type is given by the number of possible  $m_l$  values.

Solution:

sublevel	allowable $m_l$	# of possible orbitals
a) $d$ ( $l = 2$ )	$-2, -1, 0, +1, +2$	5
b) $p$ ( $l = 1$ )	$-1, 0, +1$	3
c) $f$ ( $l = 3$ )	$-3, -2, -1, 0, +1, +2, +3$	7

sublevel	allowable $m_l$	# of possible orbitals
a) $s$ ( $l = 0$ )	0	1
b) $d$ ( $l = 2$ )	$-2, -1, 0, +1, +2$	5
c) $p$ ( $l = 1$ )	$-1, 0, +1$	3

7.46 Plan: The integer in front of the letter represents the  $n$  value. The letter designates the  $l$  value:  $l = 0 = s$  orbital;  $l = 1 = p$  orbital;  $l = 2 = d$  orbital;  $l = 3 = f$  orbital. Remember that allowed  $m_l$  values are  $-l$  to  $+l$ .

Solution:

- a) For the  $5s$  subshell,  $n = 5$  and  $l = 0$ . Since  $m_l = 0$ , there is **one** orbital.  
 b) For the  $3p$  subshell,  $n = 3$  and  $l = 1$ . Since  $m_l = -1, 0, +1$ , there are **three** orbitals.  
 c) For the  $4f$  subshell,  $n = 4$  and  $l = 3$ . Since  $m_l = -3, -2, -1, 0, +1, +2, +3$ , there are **seven** orbitals.

- 7.47 a)  $n = 6$ ;  $l = 4$ ; 9 orbitals ( $m_l = -4, -3, -2, -1, 0, +1, +2, +3, +4$ )  
 b)  $n = 4$ ;  $l = 0$ ; 1 orbital ( $m_l = 0$ )  
 c)  $n = 3$ ;  $l = 2$ ; 5 orbitals ( $m_l = -2, -1, 0, +1, +2$ )

7.48 Plan: Allowed values of quantum numbers:  $n =$  positive integers;  $l =$  integers from 0 to  $n - 1$ ;  $m_l =$  integers from  $-l$  through 0 to  $+l$ .

Solution:

- a)  $n = 2$ ;  $l = 0$ ;  $m_l = -1$ : With  $n = 2$ ,  $l$  can be 0 or 1; with  $l = 0$ , the only allowable  $m_l$  value is 0. This combination is not allowed. To correct, either change the  $l$  or  $m_l$  value.  
 Correct:  $n = 2$ ;  $l = 1$ ;  $m_l = -1$  or  $n = 2$ ;  $l = 0$ ;  $m_l = 0$ .  
 b)  $n = 4$ ;  $l = 3$ ;  $m_l = -1$ : With  $n = 4$ ,  $l$  can be 0, 1, 2, or 3; with  $l = 3$ , the allowable  $m_l$  values are  $-3, -2, -1, 0, +1, +2, +3$ . Combination is allowed.  
 c)  $n = 3$ ;  $l = 1$ ;  $m_l = 0$ : With  $n = 3$ ,  $l$  can be 0, 1, or 2; with  $l = 1$ , the allowable  $m_l$  values are  $-1, 0, +1$ . Combination is allowed.  
 d)  $n = 5$ ;  $l = 2$ ;  $m_l = +3$ : With  $n = 5$ ,  $l$  can be 0, 1, 2, 3, or 4; with  $l = 2$ , the allowable  $m_l$  values are  $-2, -1, 0, +1, +2, +3$  is not an allowable  $m_l$  value. To correct, either change  $l$  or  $m_l$  value.

Correct:  $n = 5; l = 3; m_l = +3$  or  $n = 5; l = 2; m_l = 0$ .

- 7.49 a) Combination is allowed.  
b) No;  $n = 2; l = 1; m_l = +1$  or  $n = 2; l = 1; m_l = 0$   
c) No;  $n = 7; l = 1; m_l = +1$  or  $n = 7; l = 3; m_l = 0$   
d) No;  $n = 3; l = 1; m_l = -1$  or  $n = 3; l = 2; m_l = -2$

7.50 Plan: When light of sufficient frequency (energy) shines on metal, electrons in the metal break free and a current flows.

Solution:

- a) The lines do not begin at the origin because an electron must absorb a minimum amount of energy before it has enough energy to overcome the attraction of the nucleus and leave the atom. This minimum energy is the energy of photons of light at the threshold frequency.  
b) The lines for K and Ag do not begin at the same point. The amount of energy that an electron must absorb to leave the K atom is less than the amount of energy that an electron must absorb to leave the Ag atom, where the attraction between the nucleus and outer electron is stronger than in a K atom.  
c) Wavelength is inversely proportional to energy. Thus, the metal that requires a larger amount of energy to be absorbed before electrons are emitted will require a shorter wavelength of light. Electrons in Ag atoms require more energy to leave, so Ag requires a shorter wavelength of light than K to eject an electron.  
d) The slopes of the line show an increase in kinetic energy as the frequency (or energy) of light is increased. Since the slopes are the same, this means that for an increase of one unit of frequency (or energy) of light, the increase in kinetic energy of an electron ejected from K is the same as the increase in the kinetic energy of an electron ejected from Ag. After an electron is ejected, the energy that it absorbs above the threshold energy becomes the kinetic energy of the electron. For the same increase in energy above the threshold energy, for either K or Ag, the kinetic energy of the ejected electron will be the same.

7.51 a)  $E = \frac{hc}{\lambda} = \frac{(6.626 \times 10^{-34} \text{ J}\cdot\text{s})(3.00 \times 10^8 \text{ m/s})}{700. \text{ nm}} \left( \frac{1 \text{ nm}}{10^{-9} \text{ m}} \right) = 2.8397 \times 10^{-19} \text{ J}$

This is the value for each photon, that is, J/photon.

Number of photons =  $(2.0 \times 10^{-17} \text{ J}) \left( \frac{1 \text{ photon}}{2.8397 \times 10^{-19} \text{ J}} \right) = 70.430 = \mathbf{70. \text{ photons}}$

b)  $E = \frac{hc}{\lambda} = \frac{(6.626 \times 10^{-34} \text{ J}\cdot\text{s})(3.00 \times 10^8 \text{ m/s})}{475. \text{ nm}} \left( \frac{1 \text{ nm}}{10^{-9} \text{ m}} \right) = 4.18484 \times 10^{-19} \text{ J}$

This is the value for each photon, that is, J/photon.

Number of photons =  $(2.0 \times 10^{-17} \text{ J}) \left( \frac{1 \text{ photon}}{4.18484 \times 10^{-19} \text{ J}} \right) = 47.7916 = \mathbf{48 \text{ photons}}$

7.52 Determine the wavelength:

$$\lambda = 1/(1953 \text{ cm}^{-1}) = 5.1203277 \times 10^{-4} \text{ cm}$$

$$\lambda (\text{nm}) = (5.1203277 \times 10^{-4} \text{ cm}) \left( \frac{10^{-2} \text{ m}}{1 \text{ cm}} \right) \left( \frac{1 \text{ nm}}{10^{-9} \text{ m}} \right) = 5120.3277 = \mathbf{5.120 \times 10^3 \text{ nm}}$$

$$\lambda (\text{\AA}) = (5.1203277 \times 10^{-4} \text{ cm}) \left( \frac{10^{-2} \text{ m}}{1 \text{ cm}} \right) \left( \frac{1 \text{ \AA}}{10^{-10} \text{ m}} \right) = 51203.277 = \mathbf{5.120 \times 10^4 \text{ \AA}}$$

$$\nu = c/\lambda = \frac{2.9979 \times 10^8 \text{ m/s}}{5.1203277 \times 10^{-4} \text{ cm}} \left( \frac{1 \text{ cm}}{10^{-2} \text{ m}} \right) \left( \frac{1 \text{ Hz}}{1 \text{ s}^{-1}} \right) = 5.8548987 \times 10^{13} = \mathbf{5.855 \times 10^{13} \text{ Hz}}$$

7.53 Plan: The Bohr model has been successfully applied to predict the spectral lines for one-electron species other than H. Common one-electron species are small cations with all but one electron removed. Since the problem specifies a metal ion, assume that the possible choices are  $\text{Li}^{2+}$  or  $\text{Be}^{3+}$ . Use the relationship  $E = h\nu$  to convert the

frequency to energy and then solve Bohr's equation  $E = (2.18 \times 10^{-18} \text{ J}) \left( \frac{Z^2}{n^2} \right)$  to verify if a whole number for  $Z$

can be calculated. Recall that the negative sign is a convention based on the zero point of the atom's energy; it is deleted in this calculation to avoid taking the square root of a negative number.

Solution:

The highest energy line corresponds to the transition from  $n = 1$  to  $n = \infty$ .

$$E = h\nu = (6.626 \times 10^{-34} \text{ J}\cdot\text{s})(2.961 \times 10^{16} \text{ Hz}) (\text{s}^{-1}/\text{Hz}) = 1.9619586 \times 10^{-17} \text{ J}$$

$$E = (2.18 \times 10^{-18} \text{ J}) \left( \frac{Z^2}{n^2} \right) \quad Z = \text{charge of the nucleus}$$

$$Z^2 = \frac{En^2}{2.18 \times 10^{-18} \text{ J}} = \frac{1.9619586 \times 10^{-17} (1^2)}{2.18 \times 10^{-18} \text{ J}} = 8.99998$$

Then  $Z^2 = 9$  and  $Z = 3$ .

Therefore, the ion is  $\text{Li}^{2+}$  with an atomic number of 3.

$$7.54 \quad \text{a) } 59.5 \text{ MHz} \quad \lambda(\text{m}) = c/\nu = \frac{2.9979 \times 10^8 \text{ m/s}}{(59.5 \text{ MHz}) \left( \frac{10^6 \text{ Hz}}{1 \text{ MHz}} \right) \left( \frac{\text{s}^{-1}}{\text{Hz}} \right)} = 5.038487 = 5.04 \text{ m}$$

$$215.8 \text{ MHz} \quad \lambda(\text{m}) = c/\nu = \frac{2.9979 \times 10^8 \text{ m/s}}{(215.8 \text{ MHz}) \left( \frac{10^6 \text{ Hz}}{1 \text{ MHz}} \right) \left( \frac{\text{s}^{-1}}{\text{Hz}} \right)} = 1.38920 = 1.389 \text{ m}$$

Therefore, the VHF band overlaps with the 2.78–3.41 m FM band.

$$\text{b) } 550 \text{ kHz} \quad \lambda(\text{m}) = c/\nu = \frac{3.00 \times 10^8 \text{ m/s}}{(550 \text{ kHz}) \left( \frac{10^3 \text{ Hz}}{1 \text{ kHz}} \right) \left( \frac{\text{s}^{-1}}{\text{Hz}} \right)} = 545.45 = 550 \text{ m}$$

$$1600 \text{ kHz} \quad \lambda(\text{m}) = c/\nu = \frac{3.00 \times 10^8 \text{ m/s}}{(1600 \text{ kHz}) \left( \frac{10^3 \text{ Hz}}{1 \text{ kHz}} \right) \left( \frac{\text{s}^{-1}}{\text{Hz}} \right)} = 187.5 = 190 \text{ m}$$

FM width from 2.78 to 3.41 m gives 0.63 m, whereas AM width from 190 to 550 m gives 360 m.

$$7.55 \quad E = \frac{hc}{\lambda} \quad \text{thus } \lambda = \frac{hc}{E}$$

$$\text{a) } \lambda(\text{nm}) = \frac{hc}{E} = \frac{(6.626 \times 10^{-34} \text{ J}\cdot\text{s})(3.00 \times 10^8 \text{ m/s})}{4.60 \times 10^{-19} \text{ J}} \left( \frac{1 \text{ nm}}{10^{-9} \text{ m}} \right) = 432.130 = \mathbf{432 \text{ nm}}$$

$$\text{b) } \lambda(\text{nm}) = \frac{hc}{E} = \frac{(6.626 \times 10^{-34} \text{ J}\cdot\text{s})(3.00 \times 10^8 \text{ m/s})}{6.94 \times 10^{-19} \text{ J}} \left( \frac{1 \text{ nm}}{10^{-9} \text{ m}} \right) = 286.4265 = \mathbf{286 \text{ nm}}$$

$$\text{c) } \lambda(\text{nm}) = \frac{hc}{E} = \frac{(6.626 \times 10^{-34} \text{ J}\cdot\text{s})(3.00 \times 10^8 \text{ m/s})}{4.41 \times 10^{-19} \text{ J}} \left( \frac{1 \text{ nm}}{10^{-9} \text{ m}} \right) = 450.748 = \mathbf{451 \text{ nm}}$$

7.56 Plan: You are given the work function values of the three metals, which is the minimum energy required to remove an electron from the metal's surface. Use the relationship

$$E = \frac{hc}{\lambda} \text{ to find the wavelength associated with each energy value (work function).}$$

**Solution:**

a) The energy of visible light is lower than that of UV light. Thus, metal A must be **barium**, since of the three metals listed, barium has the smallest work function indicating the attraction between barium's nucleus and outer electron is less than the attraction in tantalum or tungsten. The longest wavelength corresponds to the lowest energy (work function).  $E = hc/\lambda$  thus  $\lambda = hc/E$

$$\text{Ta: } \lambda = \frac{hc}{E} = \frac{(6.626 \times 10^{-34} \text{ J}\cdot\text{s})(3.00 \times 10^8 \text{ m/s})}{6.81 \times 10^{-19} \text{ J}} \left( \frac{1 \text{ nm}}{10^{-9} \text{ m}} \right) = 291.894 = \mathbf{292 \text{ nm}}$$

$$\text{Ba: } \lambda = \frac{hc}{E} = \frac{(6.626 \times 10^{-34} \text{ J}\cdot\text{s})(3.00 \times 10^8 \text{ m/s})}{4.30 \times 10^{-19} \text{ J}} \left( \frac{1 \text{ nm}}{10^{-9} \text{ m}} \right) = 462.279 = \mathbf{462 \text{ nm}}$$

$$\text{W: } \lambda = \frac{hc}{E} = \frac{(6.626 \times 10^{-34} \text{ J}\cdot\text{s})(3.00 \times 10^8 \text{ m/s})}{7.16 \times 10^{-19} \text{ J}} \left( \frac{1 \text{ nm}}{10^{-9} \text{ m}} \right) = 277.6257 = \mathbf{278 \text{ nm}}$$

Metal A must be **barium**, because barium is the only metal that emits in the visible range (462 nm).

b) A UV range of **278 nm to 292 nm** is necessary to distinguish between tantalum and tungsten.

7.57 Extra significant figures are necessary because of the data presented in the problem.

He-Ne  $\lambda = 632.8 \text{ nm}$

Ar  $\nu = 6.148 \times 10^{14} \text{ s}^{-1}$

Ar-Kr  $E = 3.499 \times 10^{-19} \text{ J}$

Dye  $\lambda = 663.7 \text{ nm}$

Calculating missing  $\lambda$  values:

Ar  $\lambda = c/\nu = (2.9979 \times 10^8 \text{ m/s}) / (6.148 \times 10^{14} \text{ s}^{-1}) = 4.8762199 \times 10^{-7} = \mathbf{4.876 \times 10^{-7} \text{ m}}$

Ar-Kr  $\lambda = hc/E = (6.626 \times 10^{-34} \text{ J}\cdot\text{s})(2.9979 \times 10^8 \text{ m/s}) / (3.499 \times 10^{-19} \text{ J}) = 5.67707 \times 10^{-7} = \mathbf{5.677 \times 10^{-7} \text{ m}}$

Calculating missing  $\nu$  values:

He-Ne  $\nu = c/\lambda = (2.9979 \times 10^8 \text{ m/s}) / [632.8 \text{ nm} (10^{-9} \text{ m/nm})] = 4.7375 \times 10^{14} = \mathbf{4.738 \times 10^{14} \text{ s}^{-1}}$

Ar-Kr  $\nu = E/h = (3.499 \times 10^{-19} \text{ J}) / (6.626 \times 10^{-34} \text{ J}\cdot\text{s}) = 5.28071 \times 10^{14} = \mathbf{5.281 \times 10^{14} \text{ s}^{-1}}$

Dye  $\nu = c/\lambda = (2.9979 \times 10^8 \text{ m/s}) / [663.7 \text{ nm} (10^{-9} \text{ m/nm})] = 4.51695 \times 10^{14} = \mathbf{4.517 \times 10^{14} \text{ s}^{-1}}$

Calculating missing  $E$  values:

He-Ne  $E = hc/\lambda = [(6.626 \times 10^{-34} \text{ J}\cdot\text{s})(2.9979 \times 10^8 \text{ m/s})] / [632.8 \text{ nm} (10^{-9} \text{ m/nm})]$   
 $= 3.13907797 \times 10^{-19} = \mathbf{3.139 \times 10^{-19} \text{ J}}$

Ar  $E = h\nu = (6.626 \times 10^{-34} \text{ J}\cdot\text{s})(6.148 \times 10^{14} \text{ s}^{-1}) = 4.0736648 \times 10^{-19} = \mathbf{4.074 \times 10^{-19} \text{ J}}$

Dye  $E = hc/\lambda = [(6.626 \times 10^{-34} \text{ J}\cdot\text{s})(2.9979 \times 10^8 \text{ m/s})] / [663.7 \text{ nm} (10^{-9} \text{ m/nm})]$   
 $= 2.99293 \times 10^{-19} = \mathbf{2.993 \times 10^{-19} \text{ J}}$

The colors may be predicted from Figure 7.3 and the frequencies.

He-Ne  $\nu = 4.738 \times 10^{14} \text{ s}^{-1}$  **Orange**

Ar  $\nu = 6.148 \times 10^{14} \text{ s}^{-1}$  **Green**

Ar-Kr  $\nu = 5.281 \times 10^{14} \text{ s}^{-1}$  **Yellow**

Dye  $\nu = 4.517 \times 10^{14} \text{ s}^{-1}$  **Red**

7.58 **Plan:** Convert the distance in part a from km to m and use the speed of light to calculate the time needed for light to travel that distance. The frequency of the light is irrelevant. Use the given time in part b and the speed of light to calculate the distance.

**Solution:**

$$\text{a) Time} = (8.1 \times 10^7 \text{ km}) \left( \frac{10^3 \text{ m}}{1 \text{ km}} \right) \left( \frac{1 \text{ s}}{3.00 \times 10^8 \text{ m}} \right) = 270 = \mathbf{2.7 \times 10^2 \text{ s}}$$

$$\text{b) Distance} = (1.2 \text{ s}) \left( \frac{3.00 \times 10^8 \text{ m}}{\text{s}} \right) = \mathbf{3.6 \times 10^8 \text{ m}}$$



$$7.59 \quad \frac{1}{\lambda} = (1.096776 \times 10^7 \text{ m}^{-1}) \left( \frac{1}{n_1^2} - \frac{1}{n_2^2} \right)$$

$$a) \frac{1}{94.91 \text{ nm}} \left( \frac{1 \text{ nm}}{10^{-9} \text{ m}} \right) = (1.096776 \times 10^7 \text{ m}^{-1}) \left( \frac{1}{1^2} - \frac{1}{n_2^2} \right)$$

$$0.9606608 = \left( \frac{1}{1^2} - \frac{1}{n_2^2} \right)$$

$$n_2 = 5$$

$$b) \frac{1}{1281 \text{ nm}} \left( \frac{1 \text{ nm}}{10^{-9} \text{ m}} \right) = (1.096776 \times 10^7 \text{ m}^{-1}) \left( \frac{1}{n_1^2} - \frac{1}{5^2} \right)$$

$$0.071175894 = \left( \frac{1}{n_1^2} - \frac{1}{5^2} \right)$$

$$n_1 = 3$$

$$c) \frac{1}{\lambda} = (1.096776 \times 10^7 \text{ m}^{-1}) \left( \frac{1}{1^2} - \frac{1}{3^2} \right)$$

$$\frac{1}{\lambda} = 9.74912 \times 10^6 \text{ m}^{-1}$$

$$\lambda = (1.02573 \times 10^{-7} \text{ m}) \left( \frac{1 \text{ nm}}{10^{-9} \text{ m}} \right) = 102.573 = \mathbf{102.6 \text{ nm}}$$

7.60 a) Orbital **D** has the largest value of  $n$ , given that it is the largest orbital.

b)  $l = 1$  indicates a  $p$  orbital. Orbitals **A** and **C** are  $p$  orbitals.  $l = 2$  indicates a  $d$  orbital. Orbitals **B** and **D** are  $d$  orbitals.

c) In an atom, there would be **four** other orbitals with the same value of  $n$  and the same shape as orbital **B**. There would be **two** other orbitals with the same value of  $n$  and the same shape as orbital **C**.

d) Orbital **D** has the highest energy and orbital **C** has the lowest energy.

7.61 The wavelengths of light responsible for the spectral lines (for the different series) for hydrogen are related by the Rydberg equation:

$$\frac{1}{\lambda} = R \left( \frac{1}{n_1^2} - \frac{1}{n_2^2} \right) \text{ where } n = 1, 2, 3, \dots \text{ and } n_2 > n_1$$

As the values of  $n$  increase, the energies associated with  $n$  move closer. The result is that  $\Delta E$  values within a series increase by continually **smaller** values and thus, the smaller wavelength associated with these  $\Delta E$  values moves closer together. The spectral lines become closer and closer together in the short wavelength region of each series because the difference in energy associated with the transition from  $n_i$  to  $n_f$  becomes smaller and smaller with increasing distance from the nucleus.

7.62 Plan: Refer to Chapter 6 for the calculation of the amount of heat energy absorbed by a substance from its specific heat capacity and temperature change ( $q = c \times \text{mass} \times \Delta T$ ). Using this equation, calculate the energy absorbed by the water. This energy equals the energy from the microwave photons. The energy of each photon can be calculated from its wavelength:  $E = hc/\lambda$ . Dividing the total energy by the energy of each photon gives the number of photons absorbed by the water.

Solution:

$$q = c \times \text{mass} \times \Delta T$$

$$q = (4.184 \text{ J/g}^\circ\text{C})(252 \text{ g})(98 - 20.)^\circ\text{C} = 8.22407 \times 10^4 \text{ J}$$

$$E = \frac{hc}{\lambda} = \frac{(6.626 \times 10^{-34} \text{ J}\cdot\text{s})(3.00 \times 10^8 \text{ m/s})}{1.55 \times 10^{-2} \text{ m}} = 1.28245 \times 10^{-23} \text{ J/photon}$$

$$\text{Number of photons} = (8.22407 \times 10^4 \text{ J}) \left( \frac{1 \text{ photon}}{1.28245 \times 10^{-23} \text{ J}} \right) = 6.41278 \times 10^{27} = \mathbf{6.4 \times 10^{27} \text{ photons}}$$

7.63 One sample calculation will be done using the equation in the book:

$$\psi = \left( \frac{1}{\sqrt{\pi}} \right) \left( \frac{1}{a_0} \right)^{3/2} e^{-r/a_0} = \left( \frac{1}{\sqrt{\pi}} \right) \left( \frac{1}{52.92 \text{ pm}} \right)^{3/2} e^{-r/a_0} = 1.465532 \times 10^{-3} e^{-r/a_0}$$

For  $r = 50 \text{ pm}$ :

$$\psi = 1.465532 \times 10^{-3} e^{-r/a_0} = 1.465532 \times 10^{-3} e^{-50/52.92} = 5.69724 \times 10^{-4}$$

$$\psi^2 = (5.69724 \times 10^{-4})^2 = 3.24585 \times 10^{-7}$$

$$4\pi^2\psi^2 = 4\pi(50)^2(3.24585 \times 10^{-7}) = 1.0197 \times 10^{-2}$$

$r \text{ (pm)}$	$\psi \text{ (pm}^{-3/2}\text{)}$	$\psi^2 \text{ (pm}^{-3}\text{)}$	$4\pi^2\psi^2 \text{ (pm}^{-1}\text{)}$
0	$1.47 \times 10^{-3}$	$2.15 \times 10^{-6}$	0
50	$0.570 \times 10^{-3}$	$0.325 \times 10^{-6}$	$1.02 \times 10^{-2}$
100	$0.221 \times 10^{-3}$	$0.0491 \times 10^{-6}$	$0.616 \times 10^{-2}$
200	$0.0335 \times 10^{-3}$	$0.00112 \times 10^{-6}$	$0.0563 \times 10^{-2}$

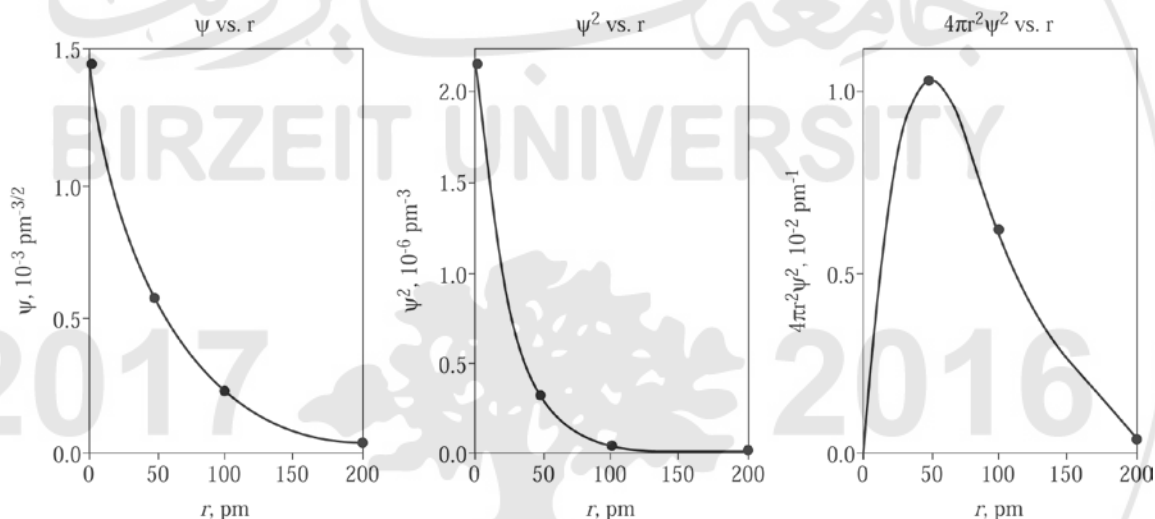

The plots are similar to Figure 7.16A in the text.

7.64 Plan: The energy differences sought may be determined by looking at the energy changes in steps. The wavelength is calculated from the relationship  $\lambda = \frac{hc}{E}$ .

Solution:

a) The difference between levels 3 and 2 ( $E_{32}$ ) may be found by taking the difference in the energies for the  $3 \rightarrow 1$  transition ( $E_{31}$ ) and the  $2 \rightarrow 1$  transition ( $E_{21}$ ).

$$E_{32} = E_{31} - E_{21} = (4.854 \times 10^{-17} \text{ J}) - (4.098 \times 10^{-17} \text{ J}) = \mathbf{7.56 \times 10^{-18} \text{ J}}$$

$$\lambda = \frac{hc}{E} = \frac{(6.626 \times 10^{-34} \text{ J}\cdot\text{s})(3.00 \times 10^8 \text{ m/s})}{(7.56 \times 10^{-18} \text{ J})} = 2.629365 \times 10^{-8} = \mathbf{2.63 \times 10^{-8} \text{ m}}$$

b) The difference between levels 4 and 1 ( $E_{41}$ ) may be found by adding the energies for the  $4 \rightarrow 2$  transition ( $E_{42}$ ) and the  $2 \rightarrow 1$  transition ( $E_{21}$ ).

$$E_{41} = E_{42} + E_{21} = (1.024 \times 10^{-17} \text{ J}) + (4.098 \times 10^{-17} \text{ J}) = \mathbf{5.122 \times 10^{-17} \text{ J}}$$

$$\lambda = \frac{hc}{E} = \frac{(6.626 \times 10^{-34} \text{ J}\cdot\text{s})(3.00 \times 10^8 \text{ m/s})}{(5.122 \times 10^{-17} \text{ J})} = 3.88091 \times 10^{-9} = \mathbf{3.881 \times 10^{-9} \text{ m}}$$

c) The difference between levels 5 and 4 ( $E_{54}$ ) may be found by taking the difference in the energies for the  $5 \rightarrow 1$  transition ( $E_{51}$ ) and the  $4 \rightarrow 1$  transition (see part b)).

$$E_{54} = E_{51} - E_{41} = (5.242 \times 10^{-17} \text{ J}) - (5.122 \times 10^{-17} \text{ J}) = \mathbf{1.2 \times 10^{-18} \text{ J}}$$

$$\lambda = \frac{hc}{E} = \frac{(6.626 \times 10^{-34} \text{ J}\cdot\text{s})(3.00 \times 10^8 \text{ m/s})}{(1.2 \times 10^{-18} \text{ J})} = 1.6565 \times 10^{-7} = \mathbf{1.66 \times 10^{-7} \text{ m}}$$

7.65 a)  $\lambda = h/mu = \frac{(6.626 \times 10^{-34} \text{ J}\cdot\text{s})}{(9.109 \times 10^{-31} \text{ kg}) \left(5.5 \times 10^4 \frac{\text{m}}{\text{s}}\right)} \left(\frac{\text{kg}\cdot\text{m}^2/\text{s}^2}{\text{J}}\right) = 1.322568 \times 10^{-8} \text{ m}$

$$\text{Smallest object} = \lambda/2 = (1.322568 \times 10^{-8} \text{ m})/2 = 6.61284 \times 10^{-9} = \mathbf{6.6 \times 10^{-9} \text{ m}}$$

b)  $\lambda = h/mu = \frac{(6.626 \times 10^{-34} \text{ J}\cdot\text{s})}{(9.109 \times 10^{-31} \text{ kg}) \left(3.0 \times 10^7 \frac{\text{m}}{\text{s}}\right)} \left(\frac{\text{kg}\cdot\text{m}^2/\text{s}^2}{\text{J}}\right) = 2.424708 \times 10^{-11} \text{ m}$

$$\text{Smallest object} = \lambda/2 = (2.424708 \times 10^{-11} \text{ m})/2 = 1.212354 \times 10^{-11} = \mathbf{1.2 \times 10^{-11} \text{ m}}$$

7.66 Plan: Examine Figure 7.3 and match the given wavelengths to their colors. For each salt, convert the mass of salt to moles and multiply by Avogadro's number to find the number of photons emitted by that amount of salt

(assuming that each atom undergoes one-electron transition). Use the relationship  $E = \frac{hc}{\lambda}$  to find the energy of one photon and multiply by the total number of photons for the total energy of emission.

Solution:

a) Figure 7.3 indicates that the 641 nm wavelength of Sr falls in the **red** region and the 493 nm wavelength of Ba falls in the **green** region.

b)  $\text{SrCl}_2$

$$\text{Number of photons} = (5.00 \text{ g SrCl}_2) \left(\frac{1 \text{ mol SrCl}_2}{158.52 \text{ g SrCl}_2}\right) \left(\frac{6.022 \times 10^{23} \text{ photons}}{1 \text{ mol SrCl}_2}\right) = 1.8994449 \times 10^{22} \text{ photons}$$

$$\lambda (\text{m}) = (641 \text{ nm}) \left(\frac{10^{-9} \text{ m}}{1 \text{ nm}}\right) = 6.41 \times 10^{-7} \text{ m}$$

$$E_{\text{photon}} = \frac{hc}{\lambda} = \frac{(6.626 \times 10^{-34} \text{ J}\cdot\text{s})(3.00 \times 10^8 \text{ m/s})}{6.41 \times 10^{-7} \text{ m}} \left(\frac{1 \text{ kJ}}{10^3 \text{ J}}\right) = 3.10109 \times 10^{-22} \text{ kJ/photon}$$

$$E_{\text{total}} = (1.8994449 \times 10^{22} \text{ photons}) \left(\frac{3.10109 \times 10^{-22} \text{ kJ}}{1 \text{ photon}}\right) = 5.89035 = \mathbf{5.89 \text{ kJ}}$$

$\text{BaCl}_2$

$$\text{Number of photons} = (5.00 \text{ g BaCl}_2) \left(\frac{1 \text{ mol BaCl}_2}{208.2 \text{ g BaCl}_2}\right) \left(\frac{6.022 \times 10^{23} \text{ photons}}{1 \text{ mol BaCl}_2}\right) = 1.44620557 \times 10^{22} \text{ photons}$$

$$\lambda (\text{m}) = (493 \text{ nm}) \left(\frac{10^{-9} \text{ m}}{1 \text{ nm}}\right) = 4.93 \times 10^{-7} \text{ m}$$

$$E_{\text{photon}} = \frac{hc}{\lambda} = \frac{(6.626 \times 10^{-34} \text{ J}\cdot\text{s})(3.00 \times 10^8 \text{ m/s})}{4.93 \times 10^{-7} \text{ m}} \left(\frac{1 \text{ kJ}}{10^3 \text{ J}}\right) = 4.0320487 \times 10^{-22} \text{ kJ/photon}$$

$$E_{\text{total}} = (1.44620557 \times 10^{22} \text{ photons}) \left(\frac{4.0320487 \times 10^{-22} \text{ kJ}}{1 \text{ photon}}\right) = 5.83117 = \mathbf{5.83 \text{ kJ}}$$

7.67 a) The highest energy line corresponds to the shortest wavelength. The shortest wavelength line is given by

$$\frac{1}{\lambda} = R \left( \frac{1}{n_1^2} - \frac{1}{n_2^2} \right) = (1.096776 \times 10^7 \text{ m}^{-1}) \left( \frac{1}{n_1^2} - \frac{1}{n_2^2} \right)$$

$$\frac{1}{3282 \text{ nm}} \left( \frac{1 \text{ nm}}{10^{-9} \text{ m}} \right) = (1.096776 \times 10^7 \text{ m}^{-1}) \left( \frac{1}{n_1^2} - \frac{1}{\infty^2} \right)$$

$$304,692 \text{ m}^{-1} = (1.096776 \times 10^7 \text{ m}^{-1}) (1/n^2)$$

$$1/n^2 = 0.0277807$$

$$n = 6$$

b) The lowest energy line corresponds to the longest wavelength. The longest wavelength line is given by

$$\frac{1}{\lambda} = (1.096776 \times 10^7 \text{ m}^{-1}) \left( \frac{1}{n_1^2} - \frac{1}{(n_1 + 1)^2} \right)$$

$$\frac{1}{7460 \text{ nm}} \left( \frac{1 \text{ nm}}{10^{-9} \text{ m}} \right) = (1.096776 \times 10^7 \text{ m}^{-1}) \left( \frac{1}{n_1^2} - \frac{1}{(n_1 + 1)^2} \right)$$

$$134,048 \text{ m}^{-1} = (1.096776 \times 10^7 \text{ m}^{-1}) \left( \frac{1}{n_1^2} - \frac{1}{(n_1 + 1)^2} \right)$$

$$0.0122220 = \left( \frac{1}{n_1^2} - \frac{1}{(n_1 + 1)^2} \right)$$

Rearranging and solving this equation for  $n_1$  yields  $n_1 = 5$ . (You and your students may well need to resort to trial-and-error solution of this equation!)

7.68 Plan: Examine Figure 7.3 to find the region of the electromagnetic spectrum in which the wavelength lies. Compare the absorbance of the given concentration of Vitamin A to the absorbance of the given amount of fish-liver oil to find the concentration of Vitamin A in the oil.

Solution:

a) At this wavelength the sensitivity to absorbance of light by Vitamin A is maximized while minimizing interference due to the absorbance of light by other substances in the fish-liver oil.

b) The wavelength 329 nm lies in the **ultraviolet region** of the electromagnetic spectrum.

c) A known quantity of vitamin A ( $1.67 \times 10^{-3}$  g) is dissolved in a known volume of solvent (250. mL) to give a standard concentration with a known response (1.018 units). This can be used to find the unknown quantity of Vitamin A that gives a response of 0.724 units. An equality can be made between the two concentration-to-absorbance ratios.

$$\text{Concentration } (C_1, \text{ g/mL}) \text{ of Vitamin A} = \left( \frac{1.67 \times 10^{-3} \text{ g}}{250. \text{ mL}} \right) = 6.68 \times 10^{-6} \text{ g/mL Vitamin A}$$

Absorbance ( $A_1$ ) of Vitamin A = 1.018 units.

Absorbance ( $A_2$ ) of fish-liver oil = 0.724 units

Concentration (g/mL) of Vitamin A in fish-liver oil sample =  $C_2$

$$\frac{A_1}{C_1} = \frac{A_2}{C_2}$$

$$C_2 = \frac{A_2 C_1}{A_1} = \frac{(0.724)(6.68 \times 10^{-6} \text{ g/mL})}{(1.018)} = 4.7508 \times 10^{-6} \text{ g/mL Vitamin A}$$

$$\text{Mass (g) of Vitamin A in oil sample} = (500. \text{ mL oil}) \left( \frac{4.7508 \times 10^{-6} \text{ g Vitamin A}}{1 \text{ mL oil}} \right) = 2.3754 \times 10^{-3} \text{ g Vitamin A}$$

$$\text{Concentration of Vitamin A in oil sample} = \frac{(2.3754 \times 10^{-3} \text{ g})}{(0.1232 \text{ g Oil})} = 1.92808 \times 10^{-2} = \mathbf{1.93 \times 10^{-2} \text{ g Vitamin A/g oil}}$$

$$7.69 \quad \lambda = hc/E = \frac{(6.626 \times 10^{-34} \text{ J}\cdot\text{s})(3.00 \times 10^8 \text{ m/s})}{(7.59 \times 10^{-19} \text{ J})} \left( \frac{1 \text{ nm}}{10^{-9} \text{ m}} \right) = 261.897 = \mathbf{262 \text{ nm}}$$

Silver is not a good choice for a photocell that uses visible light because 262 nm is in the ultraviolet region.

7.70 Mr. Green must be in the dining room where green light (520 nm) is reflected. Lower frequency, longer wavelength light is reflected in the lounge and study. Both yellow and red light have longer wavelengths than green light. Therefore, Col. Mustard and Ms. Scarlet must be in either the lounge or study. The shortest wavelengths are violet. Prof. Plum must be in the library. **Ms. Peacock** must be the murderer.

$$7.71 \quad E_k = \frac{1}{2}mv^2$$

$$v = \sqrt{\frac{E_k}{\frac{1}{2}m}} = \sqrt{\frac{4.71 \times 10^{-15} \text{ J}}{\frac{1}{2}(9.109 \times 10^{-31} \text{ kg})}} \left( \frac{\text{kg}\cdot\text{m}^2/\text{s}^2}{\text{J}} \right) = 1.01692775 \times 10^8 \text{ m/s}$$

$$\lambda = h/mv = \frac{(6.626 \times 10^{-34} \text{ J}\cdot\text{s})}{(9.109 \times 10^{-31} \text{ kg}) \left( 1.01692775 \times 10^8 \frac{\text{m}}{\text{s}} \right)} \left( \frac{\text{kg}\cdot\text{m}^2/\text{s}^2}{\text{J}} \right) = 7.15304 \times 10^{-12} = \mathbf{7.15 \times 10^{-12} \text{ m}}$$

7.72 Plan: First find the energy in joules from the light that shines on the text. Each watt is one joule/s for a total of 75 J; take 5% of that amount of joules and then 10% of that amount. Use  $E = \frac{hc}{\lambda}$  to find the energy of one photon of light with a wavelength of 550 nm. Divide the energy that shines on the text by the energy of one photon to obtain the number of photons.

Solution:

The amount of energy is calculated from the wavelength of light:

$$\lambda (\text{m}) = (550 \text{ nm}) \left( \frac{10^{-9} \text{ m}}{1 \text{ nm}} \right) = 5.50 \times 10^{-7} \text{ m}$$

$$E = \frac{hc}{\lambda} = \frac{(6.626 \times 10^{-34} \text{ J}\cdot\text{s})(3.00 \times 10^8 \text{ m/s})}{5.50 \times 10^{-7} \text{ m}} = 3.614182 \times 10^{-19} \text{ J/photon}$$

$$\text{Amount of power from the bulb} = (75 \text{ W}) \left( \frac{1 \text{ J/s}}{1 \text{ W}} \right) = 75 \text{ J/s}$$

$$\text{Amount of power converted to light} = (75 \text{ J/s}) \left( \frac{5\%}{100\%} \right) = 3.75 \text{ J/s}$$

$$\text{Amount of light shining on book} = (3.75 \text{ J/s}) \left( \frac{10\%}{100\%} \right) = 0.375 \text{ J/s}$$

$$\text{Number of photons:} \left( \frac{0.375 \text{ J}}{\text{s}} \right) \left( \frac{1 \text{ photon}}{3.614182 \times 10^{-19} \text{ J}} \right) = 1.0376 \times 10^{18} = \mathbf{1.0 \times 10^{18} \text{ photons/s}}$$

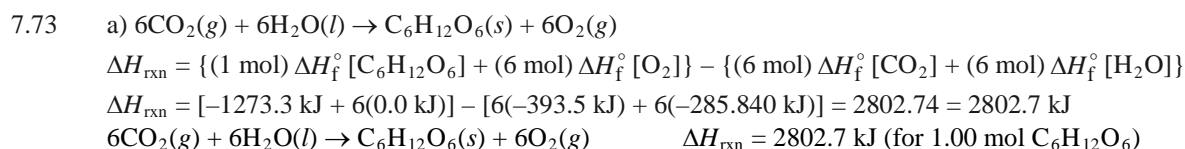

$$b) E = hc/\lambda = \frac{(6.626 \times 10^{-34} \text{ J}\cdot\text{s})(3.00 \times 10^8 \text{ m/s})}{680. \text{ nm}} \left( \frac{1 \text{ nm}}{10^{-9} \text{ m}} \right) = 2.9232353 \times 10^{-19} \text{ J/photon}$$

$$\text{Number of photons} = (2802.7 \text{ kJ}) \left( \frac{10^3 \text{ J}}{1 \text{ kJ}} \right) \left( \frac{1 \text{ photon}}{2.9232353 \times 10^{-19} \text{ J}} \right) = 9.5877 \times 10^{24} = \mathbf{9.59 \times 10^{24} \text{ photons}}$$

7.74 Use the equation  $\Delta x \cdot m\Delta u \geq \frac{h}{4\pi}$ . The uncertainty in the speed  $\Delta u$  is given as 1.00%.

$$\Delta u = 1.00\% \text{ of } u = 0.0100(100.0 \text{ mi/h}) = 1.00 \text{ mi/h}$$

$$\Delta u = \left( \frac{1.00 \text{ mi}}{\text{h}} \right) \left( \frac{1 \text{ h}}{60 \text{ min}} \right) \left( \frac{1 \text{ min}}{60 \text{ s}} \right) \left( \frac{1.609 \text{ km}}{1 \text{ mi}} \right) \left( \frac{10^3 \text{ m}}{1 \text{ km}} \right) = 0.4469 \text{ m/s}$$

$$\Delta x \geq \frac{h}{4\pi m\Delta u} \geq \frac{6.626 \times 10^{-34} \text{ J}\cdot\text{s}}{4\pi(142 \text{ g})(0.4469 \text{ m/s})} \left( \frac{10^3 \text{ g}}{1 \text{ kg}} \right) \left( \frac{1 \text{ kg}\cdot\text{m}^2/\text{s}^2}{1 \text{ J}} \right) = 8.3089 \times 10^{-34} = \mathbf{8.31 \times 10^{-34} \text{ m}}$$

جامعة بيرزيت  
BIRZEIT UNIVERSITY

2017 2016

مجلس الطلبة



# CHAPTER 8 ELECTRON CONFIGURATION AND CHEMICAL PERIODICITY

## END-OF-CHAPTER PROBLEMS

- 8.1 Elements are listed in the periodic table in an ordered, systematic way that correlates with a periodicity of their chemical and physical properties. The theoretical basis for the table in terms of atomic number and electron configuration does not allow for an “unknown element” between Sn and Sb.
- 8.2 Today, the elements are listed in order of increasing atomic number. This makes a difference in the sequence of elements in only a few cases, as the larger atomic number usually has the larger atomic mass. One of these exceptions is iodine,  $Z = 53$ , which is after tellurium,  $Z = 52$ , even though tellurium has a higher atomic mass.
- 8.3 Plan: The value should be the average of the elements above and below the one of interest.  
Solution:
- a) Predicted atomic mass (K) =  
$$\frac{\text{Na} + \text{Rb}}{2} = \frac{22.99 + 85.47}{2} = \mathbf{54.23 \text{ amu}}$$
 (actual value = 39.10 amu)
- b) Predicted melting point ( $\text{Br}_2$ ) =  
$$\frac{\text{Cl}_2 + \text{I}_2}{2} = \frac{-101.0 + 113.6}{2} = \mathbf{6.3^\circ\text{C}}$$
 (actual value =  $-7.2^\circ\text{C}$ )
- 8.4 The allowed values of  $n$ : positive integers: 1, 2, 3, 4, ... $\infty$   
The allowed values of  $l$ : integers from 0 to  $n - 1$ : 0, 1, 2, ...  $n - 1$   
The allowed values of  $m_l$ : integers from  $-l$  to 0 to  $+l$ :  $-l, (-l + 1), \dots, 0, \dots, (l - 1), +l$   
The allowed values of  $m_s$ :  $-1/2$  or  $+1/2$
- 8.5 The quantum number  $m_s$  relates to just the electron; all the others describe the orbital.
- 8.6 The exclusion principle states that no two electrons in the same atom may have the same four quantum numbers. Within a particular orbital, there can be only two electrons and they must have opposing spins.
- 8.7 In a one-electron system, all sublevels of a particular level (such as  $2s$  and  $2p$ ) have the same energy. In many electron systems, the principal energy levels are split into sublevels of differing energies. This splitting is due to electron-electron repulsions.  $\text{Be}^{3+}$  would be more like H since both have only one  $1s$  electron.
- 8.8 Shielding occurs when inner electrons protect or shield outer electrons from the full nuclear attractive force. The effective nuclear charge is the nuclear charge an electron actually experiences. As the number of inner electrons increases, shielding increases, and the effective nuclear charge decreases.
- 8.9 Penetration occurs when the probability distribution of an orbital is large near the nucleus, which results in an increase of the overall attraction of the nucleus for the electron, lowering its energy. Shielding results in lessening this effective nuclear charge on outer shell electrons, since they spend most of their time at distances farther from the nucleus and are shielded from the nuclear charge by the inner electrons. The lower the  $l$  quantum number of an orbital, the more time the electron spends penetrating near the nucleus. This results in a lower energy for a  $3p$  electron than for a  $3d$  electron in the same atom.
- 8.10 Plan: The integer in front of the letter represents the  $n$  value. The  $l$  value designates the orbital type:  $l = 0 = s$  orbital;  $l = 1 = p$  orbital;  $l = 2 = d$  orbital;  $l = 3 = f$  orbital. Remember that a  $p$  orbital set contains 3 orbitals, a  $d$  orbital set has 5 orbitals, and an  $f$  orbital set has 7 orbitals. Any one orbital can hold a maximum of 2 electrons.

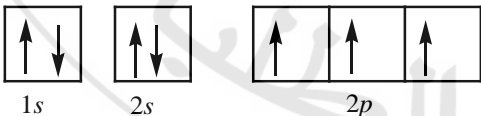
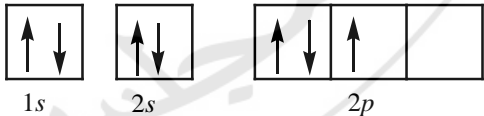

**Solution:**

- a) The  $l = 1$  quantum number can only refer to a  $p$  orbital. These quantum numbers designate the  $2p$  orbital set ( $n = 2$ ), which hold a maximum of **6** electrons, 2 electrons in each of the three  $2p$  orbitals.
- b) There are five  $3d$  orbitals, therefore a maximum of **10** electrons can have the  $3d$  designation, 2 electrons in each of the five  $3d$  orbitals.
- c) There is one  $4s$  orbital which holds a maximum of **2** electrons.
- 8.11 a) The  $l = 1$  quantum number can only refer to a  $p$  orbital, and the  $m_l$  value of 0 specifies one particular  $p$  orbital, which holds a maximum of **2** electrons.
- b) The  $5p$  orbitals, like any  $p$  orbital set, can hold a maximum of **6** electrons.
- c) The  $l = 3$  quantum number can only refer to an  $f$  orbital. These quantum numbers designate the  $4f$  orbitals, which hold a maximum of **14** electrons, 2 electrons in each of the seven  $4f$  orbitals.
- 8.12 **Plan:** The integer in front of the letter represents the  $n$  value. The  $l$  value designates the orbital type:  $l = 0 = s$  orbital;  $l = 1 = p$  orbital;  $l = 2 = d$  orbital;  $l = 3 = f$  orbital. Remember that a  $p$  orbital set contains 3 orbitals, a  $d$  orbital set has 5 orbitals, and an  $f$  orbital set has 7 orbitals. Any one orbital can hold a maximum of 2 electrons.
- Solution:**
- a) **6** electrons can be found in the three  $4p$  orbitals, 2 in each orbital.
- b) The  $l = 1$  quantum number can only refer to a  $p$  orbital, and the  $m_l$  value of +1 specifies one particular  $p$  orbital, which holds a maximum of **2** electrons with the difference between the two electrons being in the  $m_s$  quantum number.
- c) **14** electrons can be found in the  $5f$  orbitals ( $l = 3$  designates  $f$  orbitals; there are 7  $f$  orbitals in a set).
- 8.13 a) **Two** electrons, at most, can be found in any  $s$  orbital.
- b) The  $l = 2$  quantum number can only refer to a  $d$  orbital. These quantum numbers designate the  $3d$  orbitals, which hold a maximum of **10** electrons, 2 electrons in each of the five  $3d$  orbitals.
- c) A maximum of **10** electrons can be found in the five  $6d$  orbitals.
- 8.14 Properties recur periodically due to similarities in electron configurations recurring periodically.
- Na:  $1s^2 2s^2 2p^6 3s^1$
- K:  $1s^2 2s^2 2p^6 3s^2 3p^6 4s^1$
- The properties of Na and K are similar due to a similarity in their outer shell electron configuration; both have one electron in an outer shell  $s$  orbital.
- 8.15 Hund's rule states that electrons will fill empty orbitals in the same sublevel before filling half-filled orbitals. This lowest-energy arrangement has the maximum number of unpaired electrons with parallel spins. In the correct electron configuration for nitrogen shown in (a), the  $2p$  orbitals each have one unpaired electron; in the incorrect configuration shown in (b), electrons were paired in one of the  $2p$  orbitals while leaving one  $2p$  orbital empty. The arrows in the  $2p$  orbitals of configuration (a) could alternatively all point down.
- (a) – correct
- 
- (b) – incorrect
- 
- 1s 2s 2p 1s 2s 2p
- 8.16 Similarities in chemical behavior are reflected in similarities in the distribution of electrons in the highest energy orbitals. The periodic table may be re-created based on these similar outer electron configurations when orbital filling in is order of increasing energy.
- 8.17 For elements in the same group (vertical column in periodic table), the electron configuration of the outer electrons are identical except for the  $n$  value. For elements in the same period (horizontal row in periodic table), their configurations vary because each succeeding element has one additional electron. The electron configurations are similar only in the fact that the same level (principal quantum number) is the outer level.

- 8.18 **Plan:** Write the electron configuration for the atom or ion and find the electron for which you are writing the quantum numbers. Assume that the electron is in the ground-state configuration and that electrons fill in a  $p_x$ - $p_y$ - $p_z$  order. By convention, we assign the first electron to fill an orbital with an  $m_s$  value of  $+1/2$ . Also by convention,  $m_l = -1$  for the  $p_x$  orbital,  $m_l = 0$  for the  $p_y$  orbital, and  $m_l = +1$  for the  $p_z$  orbital. Also, keep in mind the following letter orbital designation for each  $l$  value:  $l = 0 = s$  orbital,  $l = 1 = p$  orbital,  $l = 2 = d$  orbital, and  $l = 3 = f$  orbital.

**Solution:**

- a) Rb:  $[\text{Kr}]5s^1$ . The outermost electron in a rubidium atom would be in a  $5s$  orbital (rubidium is in Row 5, Group 1). The quantum numbers for this electron are  $n = 5$ ,  $l = 0$ ,  $m_l = 0$ , and  $m_s = +1/2$ .
- b) The  $\text{S}^-$  ion would have the configuration  $[\text{Ne}]3s^23p^5$ . The electron added would go into the  $3p_z$  orbital and is the second electron in that orbital. Quantum numbers are  $n = 3$ ,  $l = 1$ ,  $m_l = +1$ , and  $m_s = -1/2$ .
- c) Ag atoms have the configuration  $[\text{Kr}]5s^14d^{10}$ . The electron lost would be from the  $5s$  orbital with quantum numbers  $n = 5$ ,  $l = 0$ ,  $m_l = 0$ , and  $m_s = +1/2$ .
- d) The F atom has the configuration  $[\text{He}]2s^22p^5$ . The electron gained would go into the  $2p_z$  orbital and is the second electron in that orbital. Quantum numbers are  $n = 2$ ,  $l = 1$ ,  $m_l = +1$ , and  $m_s = -1/2$ .
- 8.19 a)  $n = 2$ ;  $l = 0$ ;  $m_l = 0$ ;  $m_s = +1/2$   
 b)  $n = 4$ ;  $l = 1$ ;  $m_l = +1$ ;  $m_s = -1/2$   
 c)  $n = 6$ ;  $l = 0$ ;  $m_l = 0$ ;  $m_s = +1/2$   
 d)  $n = 2$ ;  $l = 1$ ;  $m_l = -1$ ;  $m_s = +1/2$

- 8.20 **Plan:** The atomic number gives the number of electrons and the periodic table shows the order for filling sublevels. Recall that  $s$  orbitals hold a maximum of 2 electrons, a  $p$  orbital set holds 6 electrons, a  $d$  orbital set holds 10 electrons, and an  $f$  orbital set holds 14 electrons.

**Solution:**

- a) Rb:  $1s^22s^22p^63s^23p^64s^23d^{10}4p^65s^1$   
 b) Ge:  $1s^22s^22p^63s^23p^64s^23d^{10}4p^2$   
 c) Ar:  $1s^22s^22p^63s^23p^6$
- 8.21 a) Br:  $1s^22s^22p^63s^23p^64s^23d^{10}4p^5$   
 b) Mg:  $1s^22s^22p^63s^2$   
 c) Se:  $1s^22s^22p^63s^23p^64s^23d^{10}4p^4$
- 8.22 **Plan:** The atomic number gives the number of electrons and the periodic table shows the order for filling sublevels. Recall that  $s$  orbitals hold a maximum of 2 electrons, a  $p$  orbital set holds 6 electrons, a  $d$  orbital set holds 10 electrons, and an  $f$  orbital set holds 14 electrons. Valence electrons are those in the highest energy level; in transition metals, the  $(n - 1)d$  electrons are also counted as valence electrons. For a condensed ground-state electron configuration, the electron configuration of the previous noble gas is shown by its element symbol in brackets, followed by the electron configuration of the energy level being filled.

**Solution:**

- a) Ti ( $Z = 22$ );  $[\text{Ar}]4s^23d^2$

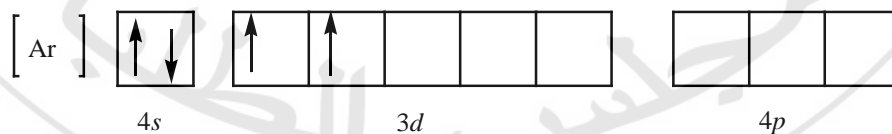

- b) Cl ( $Z = 17$ );  $[\text{Ne}]3s^23p^5$

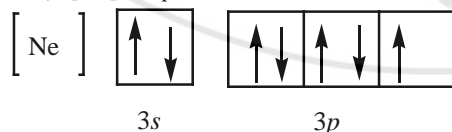

c) V ( $Z = 23$ );  $[\text{Ar}]4s^23d^3$

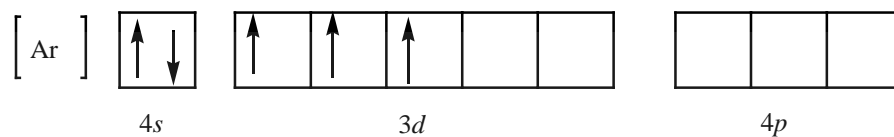

8.23 a) Ba:  $[\text{Xe}]6s^2$

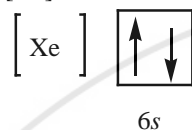

b) Co:  $[\text{Ar}]4s^23d^7$

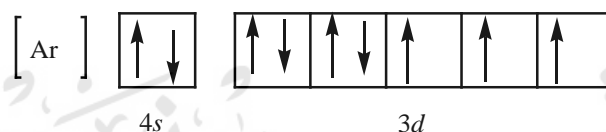

c) Ag:  $[\text{Kr}]5s^14d^{10}$

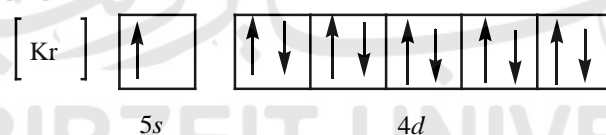

8.24 Plan: Add up all of the electrons in the electron configuration to obtain the atomic number of the element which is then used to identify the element and its position in the periodic table. When drawing the partial orbital diagram, only include electrons after those of the previous noble gas; remember to put one electron in each orbital in a set before pairing electrons.

Solution:

a) There are 8 electrons in the configuration; the element is O, Group 6A(16), Period 2.

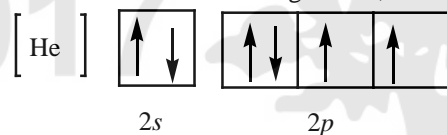

b) There are 15 electrons in the configuration; the element is P, Group 5A(15), Period 3.

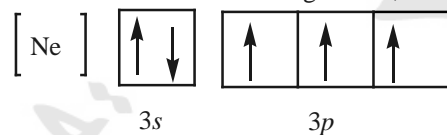

8.25 a) Cd; Group 2B(12); Period = 5

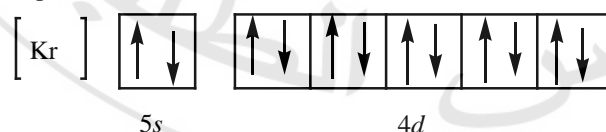

b) Ni; Group 8B(10); Period = 4

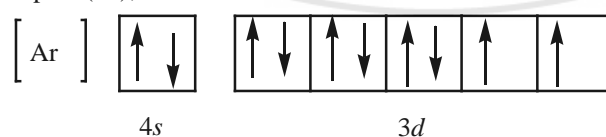

- 8.26 Plan: Use the periodic table and the partial orbital diagram to identify the element.  
Solution:  
 a) The orbital diagram shows the element is in Period 4 ( $n = 4$  as outer level). The configuration is  $1s^2 2s^2 2p^6 3s^2 3p^6 4s^2 3d^{10} 4p^1$  or  $[\text{Ar}]4s^2 3d^{10} 4p^1$ . One electron in the  $p$  level indicates the element is in Group **3A(13)**. The element is Ga.  
 b) The orbital diagram shows the  $2s$  and  $2p$  orbitals filled which would represent the last element in Period 2, Ne. The configuration is  $1s^2 2s^2 2p^6$  or  $[\text{He}]2s^2 2p^6$ . Filled  $s$  and  $p$  orbitals indicate Group **8A(18)**.

- 8.27 a) **[Kr]5s<sup>1</sup>4d<sup>4</sup>** Nb; **5B(5)**  
 b) **[He]2s<sup>2</sup>2p<sup>3</sup>** N; **5A(15)**

- 8.28 Plan: Inner electrons are those seen in the previous noble gas and completed transition series ( $d$  orbitals). Outer electrons are those in the highest energy level (highest  $n$  value). Valence electrons are the outer electrons for main-group elements; for transition metals, valence electrons also include electrons in the outermost  $d$  set of orbitals. It is easiest to determine the types of electrons by writing a condensed electron configuration.

Solution:

- a) O ( $Z = 8$ );  $[\text{He}]2s^2 2p^4$ . There are **2** inner electrons (represented by  $[\text{He}]$ ) and **6** outer electrons. The number of valence electrons (**6**) equals the outer electrons in this case.  
 b) Sn ( $Z = 50$ );  $[\text{Kr}]5s^2 4d^{10} 5p^2$ . There are 36 (from  $[\text{Kr}]$ ) + 10 (from the filled  $4d$  set) = **46** inner electrons. There are **4** outer electrons (highest energy level is  $n = 5$ ) and **4** valence electrons.  
 c) Ca ( $Z = 20$ );  $[\text{Ar}]4s^2$ . There are **2** outer electrons (the  $4s$  electrons), **2** valence electrons, and **18** inner electrons (from  $[\text{Ar}]$ ).  
 d) Fe ( $Z = 26$ );  $[\text{Ar}]4s^2 3d^6$ . There are **2** outer electrons (from  $n = 4$  level), **8** valence electrons (the  $d$  orbital electrons count in this case because the sublevel is not full), and **18** inner electrons (from  $[\text{Ar}]$ ).  
 e) Se ( $Z = 34$ );  $[\text{Ar}]4s^2 3d^{10} 4p^4$ . There are **6** outer electrons (2 + 4 in the  $n = 4$  level), **6** valence electrons (filled  $d$  sublevels count as inner electrons), and **28** inner electrons (18 from  $[\text{Ar}]$  and 10 from the filled  $3d$  set).

	<u>inner electrons</u>	<u>outer electrons</u>	<u>valence electrons</u>
a) Br	<b>28</b>	<b>7</b>	<b>7</b>
b) Cs	<b>54</b>	<b>1</b>	<b>1</b>
c) Cr	<b>18</b>	<b>1</b>	<b>6</b>
d) Sr	<b>36</b>	<b>2</b>	<b>2</b>
e) F	<b>2</b>	<b>7</b>	<b>7</b>

- 8.30 Plan: Add up all of the electrons in the electron configuration to obtain the atomic number of the element which is then used to identify the element and its position in the periodic table.

Solution:

- a) The electron configuration  $[\text{He}]2s^2 2p^1$  has a total of 5 electrons (3 + 2 from He configuration) which is element boron with symbol **B**. Boron is in Group 3A(13). Other elements in this group are **Al, Ga, In, and Tl**.  
 b) The electrons in this element total 16, 10 from the neon configuration plus 6 from the rest of the configuration. Element 16 is sulfur, **S**, in Group 6A(16). Other elements in Group 6A(16) are **O, Se, Te, and Po**.  
 c) Electrons total 3 + 54 (from xenon) = 57. Element 57 is lanthanum, **La**, in Group 3B(3). Other elements in this group are **Sc, Y, and Ac**.

- 8.31 a) **Se**; other members **O, S, Te, Po**  
 b) **Hf**; other members **Ti, Zr, Rf**  
 c) **Mn**; other members **Tc, Re, Bh**

- 8.32 a) **Mg:**  $[\text{Ne}]3s^2$   
 b) **Cl:**  $[\text{Ne}]3s^2 3p^5$   
 c) **Mn:**  $[\text{Ar}]4s^2 3d^5$   
 d) **Ne:**  $[\text{He}]2s^2 2p^6$

- 8.33 Atomic size increases down a main group and decreases across a period. Ionization energy decreases down a main group and increases across a period. These opposite trends result because as the atom gets larger, the outer electron is further from the attraction of the positive charge of the nucleus, which is what holds the electron in the atom. It thus takes less energy (lower IE) to remove the outer electron in a larger atom than to remove the outer electron in a smaller atom. As the atomic size decreases across a period due to higher  $Z_{\text{eff}}$ , it takes more energy (higher IE) to remove the outer electron.
- 8.34 a) **A = silicon; B = fluorine; C = strontium; D = sulfur**  
 b) **F < S < Si < Sr**  
 c) **Sr < Si < S < F**
- 8.35 High IEs correspond to elements in the upper right of the periodic table, while relatively low IEs correspond to elements at the lower left of the periodic table.
- 8.36 a) For a given element, successive ionization energies always increase. As each successive electron is removed, the positive charge on the ion increases, which results in a stronger attraction between the leaving electron and the ion.  
 b) When a large jump between successive ionization energies is observed, the subsequent electron must come from a full lower energy level. Thus, by looking at a series of successive ionization energies, we can determine the number of valence electrons. For instance, the electron configuration for potassium is  $[\text{Ar}]4s^1$ . The first electron lost is the one from the  $4s$  level. The second electron lost must come from the  $3p$  level, and hence breaks into the core electrons. Thus, we see a significant jump in the amount of energy for the second ionization when compared to the first ionization.  
 c) There is a large increase in ionization energy from  $\text{IE}_3$  to  $\text{IE}_4$ , suggesting that the element has 3 valence electrons. The Period 2 element would be **B**; the Period 3 element would be **Al**; and the Period 4 element would be **Ga**.
- 8.37 The first drop occurs because the  $3p$  sublevel is higher in energy than the  $3s$ , so the  $3p$  electron of Al is pulled off more easily than a  $3s$  electron of Mg. The second drop occurs because the  $3p^4$  electron occupies the same orbital as another  $3p$  electron. The resulting electron-electron repulsion raises the orbital energy and thus it is easier to remove an electron from S ( $3p^4$ ) than P ( $3p^3$ ).
- 8.38 A high, endothermic  $\text{IE}_1$  means it is very difficult to remove the first outer electron. This value would exclude any metal, because metals lose an outer electron easily. A very negative, exothermic  $\text{EA}_1$  suggests that this element easily gains one electron. These values indicate that the element belongs to the halogens, Group **7A(17)**, which form **-1** ions.
- 8.39 After an initial shrinking for the first 2 or 3 elements, the size remains relatively constant as the shielding of the  $3d$  electrons just counteracts the increase in the number of protons in the nucleus so the  $Z_{\text{eff}}$  remains relatively constant.
- 8.40 Plan: Atomic size decreases up a main group and left to right across a period.  
Solution:  
 a) Increasing atomic size: **K < Rb < Cs**; these three elements are all part of the same group, the alkali metals. Atomic size decreases up a main group (larger outer electron orbital), so potassium is the smallest and cesium is the largest.  
 b) Increasing atomic size: **O < C < Be**; these three elements are in the same period and atomic size decreases across a period (increasing effective nuclear charge), so beryllium is the largest and oxygen the smallest.  
 c) Increasing atomic size: **Cl < S < K**; chlorine and sulfur are in the same period so chlorine is smaller since it is further to the right in the period. Potassium is the first element in the next period so it is larger than either Cl or S.  
 d) Increasing atomic size: **Mg < Ca < K**; calcium is larger than magnesium because Ca is further down the alkaline earth metal group on the periodic table than Mg. Potassium is larger than calcium because K is further to the left than Ca in Period 4 of the periodic table.
- 8.41 a) **Pb > Sn > Ge** b) **Sr > Sn > Te** c) **Na > F > Ne** d) **Na > Mg > Be**

- 8.42 Plan: Ionization energy increases up a group and left to right across a period.  
Solution:  
 a) **Ba < Sr < Ca** The “group” rule applies in this case. Ionization energy increases up a main group. Barium’s outer electron receives the most shielding; therefore, it is easiest to remove and has the lowest IE.  
 b) **B < N < Ne** These elements have the same  $n$ , so the “period” rule applies. Ionization energy increases from left to right across a period. B experiences the lowest  $Z_{\text{eff}}$  and has the lowest IE. Ne has the highest IE, because it’s very difficult to remove an electron from the stable noble gas configuration.  
 c) **Rb < Se < Br** IE decreases with increasing atomic size, so Rb (largest atom) has the smallest IE. Se has a lower IE than Br because IE increases across a period.  
 d) **Sn < Sb < As** IE increases up a group, so Sn and Sb will have smaller IEs than As. The “period” rule applies for ranking Sn and Sb.
- 8.43 a) **Li > Na > K**    b) **F > C > Be**    c) **Ar > Cl > Na**    d) **Cl > Br > Se**
- 8.44 Plan: When a large jump between successive ionization energies is observed, the subsequent electron must come from a full lower energy level. Thus, by looking at a series of successive ionization energies, we can determine the number of valence electrons. The number of valence electrons identifies which group the element is in.  
Solution:  
 The successive ionization energies show a very significant jump between the third and fourth IEs. This indicates that the element has three valence electrons. The fourth electron must come from the core electrons and thus has a very large ionization energy. The electron configuration of the Period 2 element with three valence electrons is  $1s^2 2s^2 2p^1$  which represents boron, **B**.
- 8.45 The successive ionization energies show a significant jump between the second and third IEs, indicating that the element has only two valence electrons. The configuration is  $1s^2 2s^2 2p^6 3s^2$ , **Mg**.
- 8.46 Plan: For a given element, successive ionization energies always increase. As each successive electron is removed, the positive charge on the ion increases, which results in a stronger attraction between the leaving electron and the ion. A very large jump between successive ionization energies will occur when the electron to be removed comes from a full lower energy level. Examine the electron configurations of the atoms. If the  $IE_2$  represents removing an electron from a full orbital, then the  $IE_2$  will be very large. In addition, for atoms with the same outer electron configuration,  $IE_2$  is larger for the smaller atom.  
Solution:  
 a) **Na** would have the highest  $IE_2$  because ionization of a second electron would require breaking the stable [Ne] configuration:  
 First ionization:  $\text{Na} ([\text{Ne}]3s^1) \rightarrow \text{Na}^+ ([\text{Ne}]) + e^-$  (low IE)  
 Second ionization:  $\text{Na}^+ ([\text{Ne}]) \rightarrow \text{Na}^{2+} ([\text{He}]2s^2 2p^5) + e^-$  (high IE)  
 b) **Na** would have the highest  $IE_2$  because it has one valence electron and is smaller than K.  
 c) You might think that Sc would have the highest  $IE_2$ , because removing a second electron would require breaking the stable, filled 4s shell. However, **Be** has the highest  $IE_2$  because Be’s small size makes it difficult to remove a second electron.
- 8.47 a) **Al**    b) **Sc**    c) **Al**
- 8.48 Three of the ways that metals and nonmetals differ are: 1) metals conduct electricity, nonmetals do not; 2) when they form stable ions, metal ions tend to have a positive charge, nonmetal ions tend to have a negative charge; and 3) metal oxides are ionic and act as bases, nonmetal oxides are covalent and act as acids.
- 8.49 Metallic character increases down a group and decreases toward the right across a period. These trends are the same as those for atomic size and opposite those for ionization energy.
- 8.50 Generally, oxides of metals are basic while oxides of nonmetals are acidic. As the metallic character decreases, the oxide becomes more acidic. Thus, oxide acidity increases from left to right across a period and from bottom to top in a group.

8.51 An  $(n-1)d^{10}ns^0np^0$  configuration is called a pseudo-noble gas configuration.  $\text{In}^{3+}$ :  $[\text{Kr}]4d^{10}$

8.52  $3+ < 2+ < 1+ < 0 < 1- < 2- < 3-$

8.53 Plan: Metallic behavior decreases up a group and decreases left to right across a period.

Solution:

a) **Rb** is more metallic because it is to the left and below Ca.

b) **Ra** is more metallic because it lies below Mg in Group 2A(2).

c) **I** is more metallic because it lies below Br in Group 7A(17).

8.54 a) **S**    b) **In**    c) **As**

8.55 Plan: For main-group elements, the most stable ions have electron configurations identical to noble gas atoms. Write the electron configuration of the atom and then remove or add electrons until a noble gas configuration is achieved. Metals lose electrons and nonmetals gain electrons.

Solution:

a) Cl:  $1s^2 2s^2 2p^6 3s^2 3p^5$ ; chlorine atoms are one electron short of a noble gas configuration, so a  $-1$  ion will form by adding an electron to have the same electron configuration as an argon atom:  $\text{Cl}^-$ ,  $1s^2 2s^2 2p^6 3s^2 3p^6$ .

b) Na:  $1s^2 2s^2 2p^6 3s^1$ ; sodium atoms contain one more electron than the noble gas configuration of neon. Thus, a sodium atom loses one electron to form a  $+1$  ion:  $\text{Na}^+$ ,  $1s^2 2s^2 2p^6$ .

c) Ca:  $1s^2 2s^2 2p^6 3s^2 3p^6 4s^2$ ; calcium atoms contain two more electrons than the noble gas configuration of argon. Thus, a calcium atom loses two electrons to form a  $+2$  ion:  $\text{Ca}^{2+}$ ,  $1s^2 2s^2 2p^6 3s^2 3p^6$ .

8.56 a)  $\text{Rb}^+$ :  $1s^2 2s^2 2p^6 3s^2 3p^6 4s^2 3d^{10} 4p^6$     +1  
 b)  $\text{N}^{3-}$ :  $1s^2 2s^2 2p^6$     -3  
 c)  $\text{Br}^-$ :  $1s^2 2s^2 2p^6 3s^2 3p^6 4s^2 3d^{10} 4p^6$     -1

8.57 Plan: To find the number of unpaired electrons look at the electron configuration expanded to include the different orientations of the orbitals, such as  $p_x$  and  $p_y$  and  $p_z$ . Remember that one electron will occupy every orbital in a set ( $p$ ,  $d$ , or  $f$ ) before electrons will pair in an orbital in that set. In the noble gas configurations, all electrons are paired because all orbitals are filled.

Solution:

a) Configuration of 2A(2) group elements:  $[\text{noble gas}]ns^2$ , **no unpaired electrons**. The electrons in the  $ns$  orbital are paired.

b) Configuration of 5A(15) group elements:  $[\text{noble gas}]ns^2 np_x^1 np_y^1 np_z^1$ . **Three** unpaired electrons, one each in  $p_x$ ,  $p_y$ , and  $p_z$ .

c) Configuration of 8A(18) group elements: noble gas configuration  $ns^2 np^6$  with no half-filled orbitals, **no unpaired electrons**.

d) Configuration of 3A(13) group elements:  $[\text{noble gas}]ns^2 np^1$ . There is **one** unpaired electron in one of the  $p$  orbitals.



a)  $ns$



b)  $ns$                    $np$

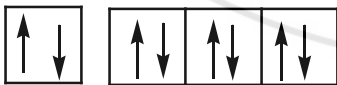

c)  $ns$                    $np$

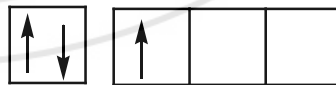

d)  $ns$                    $np$

8.58 To find the number of unpaired electrons look at the electron configuration expanded to include the different orientations of the orbitals, such as  $p_x$  and  $p_y$  and  $p_z$ . In the noble gas configurations, all electrons are paired because all orbitals are filled.

- a) Configuration of 4A(14) group elements: [noble gas] $ns^2np_x^1np_y^1np_z^0$ . **Two** unpaired electrons.  
 b) Configuration of 7A(17) group elements: [noble gas] $ns^2np_x^2np_y^2np_z^1$ . **One** unpaired electron.  
 c) Configuration of 1A(1) group elements: [noble gas] $ns^1$ . **One** unpaired electron.  
 d) Configuration of 6A(16) group elements: [noble gas] $ns^2np_x^2np_y^1np_z^1$ . **Two** unpaired electrons.

8.59 Plan: Substances are paramagnetic if they have unpaired electrons. Write the electron configuration of the atom and then remove the specified number of electrons. Remember that all orbitals in a  $p$ ,  $d$ , or  $f$  set will each have one electron before electrons pair in an orbital. In the noble gas configurations, all electrons are paired because all orbitals are filled.

Solution:

a) V: [Ar] $4s^23d^3$ ;  $V^{3+}$ : [Ar] $3d^2$  Transition metals first lose the  $s$  electrons in forming ions, so to form the +3 ion a vanadium atom loses two  $4s$  electrons and one  $3d$  electron. **Paramagnetic**

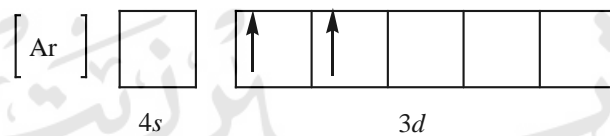

b) Cd: [Kr] $5s^24d^{10}$ ;  $Cd^{2+}$ : [Kr] $4d^{10}$  Cadmium atoms lose two electrons from the  $4s$  orbital to form the +2 ion. **Diamagnetic**

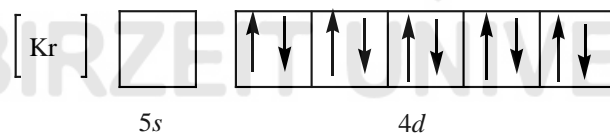

c) Co: [Ar] $4s^23d^7$ ;  $Co^{3+}$ : [Ar] $3d^6$  Cobalt atoms lose two  $4s$  electrons and one  $3d$  electron to form the +3 ion. **Paramagnetic**

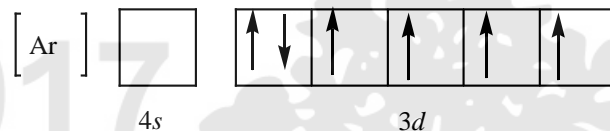

d) Ag: [Kr] $5s^14d^{10}$ ;  $Ag^+$ : [Kr] $4d^{10}$  Silver atoms lose the one electron in the  $5s$  orbital to form the +1 ion. **Diamagnetic**

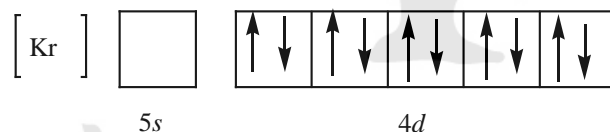

- 8.60 a)  $Mo^{3+}$ : [Kr] $4d^3$  **paramagnetic**  
 b)  $Au^+$ : [Xe] $4f^{14}5d^{10}$  **diamagnetic**  
 c)  $Mn^{2+}$ : [Ar] $3d^5$  **paramagnetic**  
 d)  $Hf^{2+}$ : [Xe] $4f^{14}5d^2$  **paramagnetic**

8.61 Plan: Substances are diamagnetic if they have no unpaired electrons. Draw the partial orbital diagrams, remembering that all orbitals in  $d$  set will each have one electron before electrons pair in an orbital.

Solution:

You might first write the condensed electron configuration for Pd as [Kr] $5s^24d^8$ . However, the partial orbital diagram is not consistent with diamagnetism.

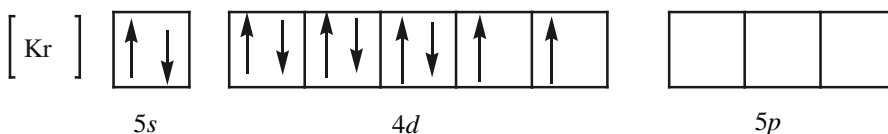

Promoting an  $s$  electron into the  $d$  sublevel (as in (c) [Kr] $5s^14d^9$ ) still leaves two electrons unpaired.



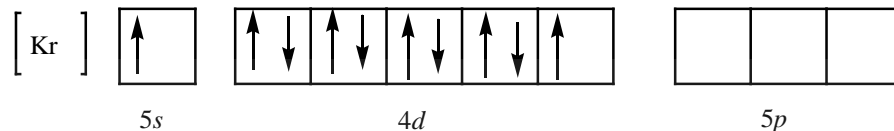

The only configuration that supports diamagnetism is (b)  $[\text{Kr}]4d^{10}$ .

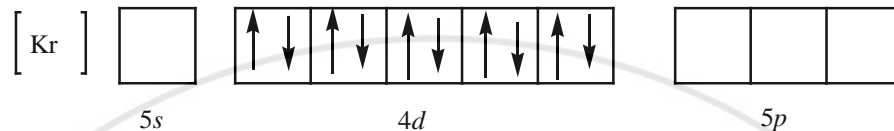

- 8.62 The expected electron configuration for Group 5B(5) elements is  $ns^2(n-1)d^3$ .  
 Nb (expected):  $[\text{Kr}]5s^24d^3$  3 unpaired  $e^-$



Nb (actual):  $[\text{Kr}]5s^14d^4$  5 unpaired  $e^-$

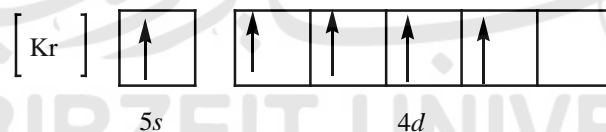

- 8.63 Plan: The size of ions increases down a group. For ions that are isoelectronic (have the same electron configuration) size decreases with increasing atomic number.

Solution:

- a) Increasing size:  $\text{Li}^+ < \text{Na}^+ < \text{K}^+$ , size increases down Group 1A(1).  
 b) Increasing size:  $\text{Rb}^+ < \text{Br}^- < \text{Se}^{2-}$ , these three ions are isoelectronic with the same electron configuration as krypton. Size decreases with increasing atomic number in an isoelectronic series.  
 c) Increasing size:  $\text{F}^- < \text{O}^{2-} < \text{N}^{3-}$ , the three ions are isoelectronic with an electron configuration identical to neon. Size decreases with increasing atomic number in an isoelectronic series.
- 8.64 a)  $\text{Se}^{2-} > \text{S}^{2-} > \text{O}^{2-}$ , size increases down a group.  
 b)  $\text{Te}^{2-} > \text{I}^- > \text{Cs}^+$ , size decreases with increasing atomic number in an isoelectronic series.  
 c)  $\text{Cs}^+ > \text{Ba}^{2+} > \text{Sr}^{2+}$ , both reasons as in parts a) and b).

- 8.65 a) oxygen      b) cesium      c) aluminum      d) carbon      e) rubidium      f) bismuth  
 g) thallium      h) krypton      i) silicon      j) ruthenium      k) vanadium      l) indium  
 m) scandium      n) manganese      o) lutetium      p) sulfur      q) strontium      r) arsenic

- 8.66 Plan: Write the formula of the oxoacid. Remember that in naming oxoacids (H + polyatomic ion), the suffix of the polyatomic changes: -ate becomes -ic acid and -ite becomes -ous acid. Determine the oxidation state of the nonmetal in the oxoacid; hydrogen has an O.N. of +1 and oxygen has an O.N. of -2. Based on the oxidation state of the nonmetal, and the oxidation state of the oxide ion (-2), the formula of the nonmetal oxide may be determined. The name of the nonmetal oxide comes from the formula; remember that nonmetal compounds use prefixes to indicate the number of each type of atom in the formula.

Solution:

- a) hypochlorous acid =  $\text{HClO}$  has  $\text{Cl}^+$  so the oxide is  $\text{Cl}_2\text{O}$  = **dichlorine oxide** or **dichlorine monoxide**  
 b) chlorous acid =  $\text{HClO}_2$  has  $\text{Cl}^{3+}$  so the oxide is  $\text{Cl}_2\text{O}_3$  = **dichlorine trioxide**  
 c) chloric acid =  $\text{HClO}_3$  has  $\text{Cl}^{5+}$  so the oxide is  $\text{Cl}_2\text{O}_5$  = **dichlorine pentaoxide**  
 d) perchloric acid =  $\text{HClO}_4$  has  $\text{Cl}^{7+}$  so the oxide is  $\text{Cl}_2\text{O}_7$  = **dichlorine heptaoxide**  
 e) sulfuric acid =  $\text{H}_2\text{SO}_4$  has  $\text{S}^{6+}$  so the oxide is  $\text{SO}_3$  = **sulfur trioxide**  
 f) sulfurous acid =  $\text{H}_2\text{SO}_3$  has  $\text{S}^{4+}$  so the oxide is  $\text{SO}_2$  = **sulfur dioxide**  
 g) nitric acid =  $\text{HNO}_3$  has  $\text{N}^{5+}$  so the oxide is  $\text{N}_2\text{O}_5$  = **dinitrogen pentaoxide**

- h) nitrous acid =  $\text{HNO}_2$  has  $\text{N}^{3+}$  so the oxide is  $\text{N}_2\text{O}_3$  = **dinitrogen trioxide**  
 i) carbonic acid =  $\text{H}_2\text{CO}_3$  has  $\text{C}^{4+}$  so the oxide is  $\text{CO}_2$  = **carbon dioxide**  
 j) phosphoric acid =  $\text{H}_3\text{PO}_4$  has  $\text{P}^{5+}$  so the oxide is  $\text{P}_2\text{O}_5$  = **diphosphorus pentoxide or  $\text{P}_4\text{O}_{10}$  = tetraphosphorus decaoxide.**

$$8.67 \quad \lambda = hc/\Delta E = \frac{(6.626 \times 10^{-34} \text{ J}\cdot\text{s})(3.00 \times 10^8 \text{ m/s})}{(2.7 \text{ eV}) \left( \frac{1.602 \times 10^{-19} \text{ J}}{1 \text{ eV}} \right)} = 4.59564 \times 10^{-7} = 4.6 \times 10^{-7} \text{ m}$$

The absorption of light of this wavelength (blue) leads to the complimentary color (yellow) being seen. An electron in gold's  $5d$  subshell can absorb blue light in its transition to a  $6s$  subshell, giving gold its characteristic "gold" color.

- 8.68 **Plan:** Remember that isoelectronic species have the same electron configuration. Atomic radius decreases up a group and left to right across a period.

**Solution:**

- a) A chemically unreactive Period 4 element would be Kr in Group 8A(18). Both the  $\text{Sr}^{2+}$  ion and  $\text{Br}^-$  ion are isoelectronic with Kr. Their combination results in  **$\text{SrBr}_2$ , strontium bromide.**  
 b) Ar is the Period 3 noble gas.  $\text{Ca}^{2+}$  and  $\text{S}^{2-}$  are isoelectronic with Ar. The resulting compound is **CaS, calcium sulfide.**  
 c) The smallest filled  $d$  subshell is the  $3d$  shell, so the element must be in Period 4. Zn forms the  $\text{Zn}^{2+}$  ion by losing its two  $s$  subshell electrons to achieve a *pseudo-noble gas* configuration ( $[\text{Ar}]3d^{10}$ ). The smallest halogen is fluorine, whose anion is  $\text{F}^-$ . The resulting compound is  **$\text{ZnF}_2$ , zinc fluoride.**  
 d) Ne is the smallest element in Period 2, but it is not ionizable. Li is the largest atom whereas F is the smallest atom in Period 2. The resulting compound is **LiF, lithium fluoride.**

- 8.69 **Plan:** Determine the electron configuration for iron, and then begin removing one electron at a time. Remember that all orbitals in a  $d$  set will each have one electron before electrons pair in an orbital, and electrons with the highest  $n$  value are removed first. Ions with all electrons paired are diamagnetic. Ions with at least one unpaired electron are paramagnetic. The more unpaired electrons, the greater the attraction to a magnetic field.

**Solution:**

Fe	$[\text{Ar}]4s^23d^6$	partially filled $3d$ = <b>paramagnetic</b>	number of unpaired electrons = 4
$\text{Fe}^+$	$[\text{Ar}]4s^13d^6$	partially filled $3d$ = <b>paramagnetic</b>	number of unpaired electrons = 5
$\text{Fe}^{2+}$	$[\text{Ar}]3d^6$	partially filled $3d$ = <b>paramagnetic</b>	number of unpaired electrons = 4
$\text{Fe}^{3+}$	$[\text{Ar}]3d^5$	partially filled $3d$ = <b>paramagnetic</b>	number of unpaired electrons = 5
$\text{Fe}^{4+}$	$[\text{Ar}]3d^4$	partially filled $3d$ = <b>paramagnetic</b>	number of unpaired electrons = 4
$\text{Fe}^{5+}$	$[\text{Ar}]3d^3$	partially filled $3d$ = <b>paramagnetic</b>	number of unpaired electrons = 3
$\text{Fe}^{6+}$	$[\text{Ar}]3d^2$	partially filled $3d$ = <b>paramagnetic</b>	number of unpaired electrons = 2
$\text{Fe}^{7+}$	$[\text{Ar}]3d^1$	partially filled $3d$ = <b>paramagnetic</b>	number of unpaired electrons = 1
$\text{Fe}^{8+}$	$[\text{Ar}]$	filled orbitals = <b>diamagnetic</b>	number of unpaired electrons = 0
$\text{Fe}^{9+}$	$[\text{Ne}]3s^23p^5$	partially filled $3p$ = <b>paramagnetic</b>	number of unpaired electrons = 1
$\text{Fe}^{10+}$	$[\text{Ne}]3s^23p^4$	partially filled $3p$ = <b>paramagnetic</b>	number of unpaired electrons = 2
$\text{Fe}^{11+}$	$[\text{Ne}]3s^23p^3$	partially filled $3p$ = <b>paramagnetic</b>	number of unpaired electrons = 3
$\text{Fe}^{12+}$	$[\text{Ne}]3s^23p^2$	partially filled $3p$ = <b>paramagnetic</b>	number of unpaired electrons = 2
$\text{Fe}^{13+}$	$[\text{Ne}]3s^23p^1$	partially filled $3p$ = <b>paramagnetic</b>	number of unpaired electrons = 1
$\text{Fe}^{14+}$	$[\text{Ne}]3s^2$	filled orbitals = <b>diamagnetic</b>	number of unpaired electrons = 0

**$\text{Fe}^+$  and  $\text{Fe}^{3+}$  would both be most attracted to a magnetic field. They each have 5 unpaired electrons.**

- 8.70 a) Rubidium atoms form **+1** ions,  $\text{Rb}^+$ ; bromine atoms form **-1** ions,  $\text{Br}^-$ .  
 b) Rb:  $[\text{Kr}]5s^1$ ;  $\text{Rb}^+$ :  $[\text{Kr}]$ ;  $\text{Rb}^+$  is a diamagnetic ion that is isoelectronic with Kr.  
 Br:  $[\text{Ar}]4s^23d^{10}4p^5$ ;  $\text{Br}^-$ :  $[\text{Ar}]4s^23d^{10}4p^6$  or  $[\text{Kr}]$ ;  $\text{Br}^-$  is a diamagnetic ion that is isoelectronic with Kr.  
 c)  $\text{Rb}^+$  is a smaller ion than  $\text{Br}^-$ ; **B** best represents the relative ionic sizes.
- 8.71 a)  $\text{X}^{2+} = [\text{Kr}]4d^8$ ;  $\text{X} = [\text{Kr}]5s^24d^8$ . The element is **palladium** and the oxide is  **$\text{PdO}$ .**  
 b)  $\text{X}^{3+} = [\text{Ar}]3d^6$ ;  $\text{X} = [\text{Ar}]4s^23d^6$ . The element is **cobalt** and the oxide is  **$\text{Co}_2\text{O}_3$ .**  
 c)  $\text{X}^+ = [\text{Kr}]4d^{10}$ ;  $\text{X} = [\text{Kr}]5s^14d^{10}$ . The element is **silver** and the oxide is  **$\text{Ag}_2\text{O}$ .**

d):  $X^{+4} = [\text{Ar}]3d^3$ ;  $X = [\text{Ar}]4s^23d^5$ . The element is **manganese** and the oxide is **MnO<sub>2</sub>**.

8.72 There is a large increase in ionization energy from  $\text{IE}_3$  to  $\text{IE}_4$ , suggesting that the element has 3 valence electrons. The Period 2 element would be **B**; the Period 3 element would be **Al** and the Period 4 element would be **Ga**.

8.73

balloonium	=	helium
inertium	=	neon
allotropium	=	sulfur
brinium	=	sodium
canium	=	tin
fertilium	=	nitrogen
liquidium	=	bromine
utilium	=	aluminum
crimsonium	=	strontium



# CHAPTER 9 MODELS OF CHEMICAL BONDING

## END-OF-CHAPTER PROBLEMS

- 9.1 a) Larger ionization energy decreases metallic character.  
b) Larger atomic radius increases metallic character.  
c) Larger number of outer electrons decreases metallic character.  
d) Larger effective nuclear charge decreases metallic character.
- 9.2 A has **covalent** bonding, B has **ionic** bonding, and C has **metallic** bonding.
- 9.3 The tendency of main-group elements to form cations decreases from Group 1A(1) to 4A(14), and the tendency to form anions increases from Group 4A(14) to 7A(17). Group 1A(1) and 2A(2) elements form mono- and divalent cations, respectively, while Group 6A(16) and 7A(17) elements form di- and monovalent anions, respectively.
- 9.4 Plan: Metallic behavior increases to the left and down a group in the periodic table.  
Solution:  
a) Cs is more metallic since it is further down the alkali metal group than Na.  
b) Rb is more metallic since it is both to the left and down from Mg.  
c) As is more metallic since it is further down Group 5A(15) than N.
- 9.5 a) O b) Be c) Se
- 9.6 Plan: Ionic bonding occurs between metals and nonmetals, covalent bonding between nonmetals, and metallic bonds between metals.  
Solution:  
a) Bond in CsF is **ionic** because Cs is a metal and F is a nonmetal.  
b) Bonding in N<sub>2</sub> is **covalent** because N is a nonmetal.  
c) Bonding in Na(s) is **metallic** because this is a monatomic, metal solid.
- 9.7 a) **covalent** b) **covalent** c) **ionic**
- 9.8 Plan: Lewis electron-dot symbols show valence electrons as dots. Place one dot at a time on the four sides (this method explains the structure in b) and then pair up dots until all valence electrons are used. The group number of the main-group elements (Groups 1A(1)-8A(18)) gives the number of valence electrons. Rb is Group 1A(1), Si is Group 4A(14), and I is Group 7A(17).  
Solution:
- a) Rb •      b) • Si •      c) • I •
- 9.9
- a) •Ba•      b) • Kr •      c) • Br •
- 9.10 Plan: Assuming X is an A-group element, the number of dots (valence electrons) equals the group number. Once the group number is known, the general electron configuration of the element can be written.

**Solution:**

a) Since there are 6 dots in the Lewis electron-dot symbol, element X has 6 valence electrons and is a Group **6A(16)** element. Its general electron configuration is **[noble gas] $ns^2np^4$** , where  $n$  is the energy level.

b) Since there are 3 dots in the Lewis electron-dot symbol, element X has 3 valence electrons and is a Group **3A(13)** element with general electron configuration **[noble gas] $ns^2np^1$** .

- 9.11 a) **5A(15);  $ns^2np^3$**   
b) **4A(14);  $ns^2np^2$**
- 9.12 Energy is required to form the cations and anions in ionic compounds but energy is released when the oppositely charged ions come together to form the compound. This energy is the lattice energy and more than compensates for the required energy to form ions from metals and nonmetals.
- 9.13 a) Because the lattice energy is the result of electrostatic attractions among the oppositely charged ions, its magnitude depends on several factors, including ionic size, ionic charge, and the arrangement of ions in the solid. For a particular arrangement of ions, the lattice energy increases as the charges on the ions increase and as their radii decrease.  
b) Increasing lattice energy: **A < B < C**
- 9.14 The lattice energy releases even more energy when the gas is converted to the solid.
- 9.15 The lattice energy drives the energetically unfavorable electron transfer resulting in solid formation.
- 9.16 Plan: Write condensed electron configurations and draw the Lewis electron-dot symbols for the atoms. The group number of the main-group elements (Groups **1A(1)-8A(18)**) gives the number of valence electrons. Remove electrons from the metal and add electrons to the nonmetal to attain filled outer levels. The number of electrons lost by the metal must equal the number of electrons gained by the nonmetal.

Solution:

a) Barium is a metal and loses 2 electrons to achieve a noble gas configuration:

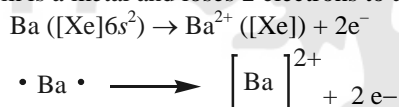

Chlorine is a nonmetal and gains 1 electron to achieve a noble gas configuration:

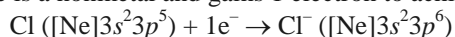

Two Cl atoms gain the 2 electrons lost by Ba. The ionic compound formed is **BaCl<sub>2</sub>**.

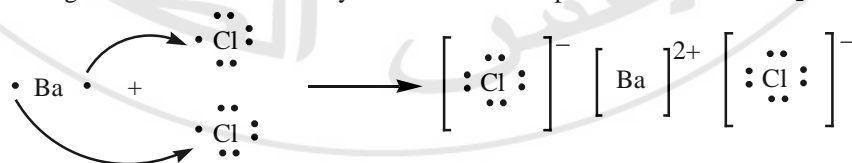

b) Strontium is a metal and loses 2 electrons to achieve a noble gas configuration:

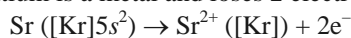

Oxygen is a nonmetal and gains 2 electrons to achieve a noble gas configuration:

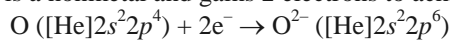

One O atom gains the two electrons lost by one Sr atom. The ionic compound formed is **SrO**.

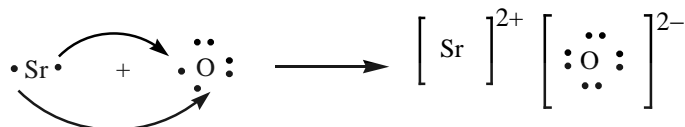

c) Aluminum is a metal and loses 3 electrons to achieve a noble gas configuration:

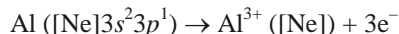

Fluorine is a nonmetal and gains 1 electron to achieve a noble gas configuration:

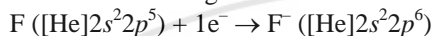

Three F atoms gain the three electrons lost by one Al atom. The ionic compound formed is **AlF<sub>3</sub>**.

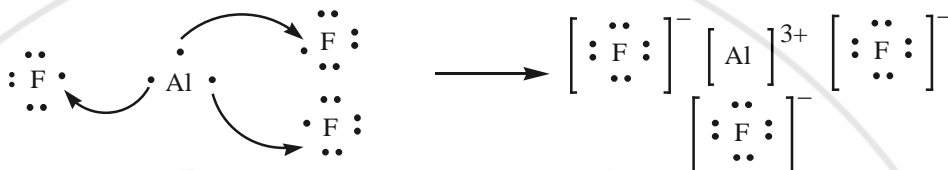

d) Rubidium is a metal and loses 1 electron to achieve a noble gas configuration:

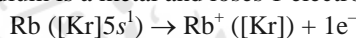

Oxygen is a nonmetal and gains 2 electrons to achieve a noble gas configuration:

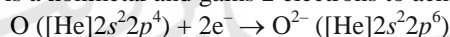

One O atom gains the two electrons lost by two Rb atoms. The ionic compound formed is **Rb<sub>2</sub>O**.



9.17 a) Cesium loses 1 electron to achieve a noble gas configuration:

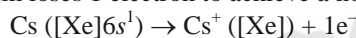

Sulfur gains 2 electrons to achieve a noble gas configuration:

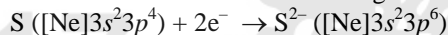

One S atom gains the two electrons lost by two Cs atoms. The ionic compound formed is **Cs<sub>2</sub>S**.

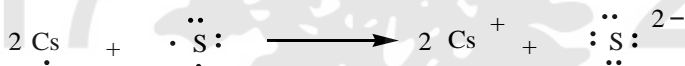

b) Gallium loses 3 electrons to achieve a noble gas configuration:

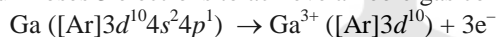

Oxygen gains 2 electrons to achieve a noble gas configuration:

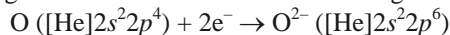

Three O atoms gain the six electrons lost by two Ga atoms. The ionic compound formed is **Ga<sub>2</sub>O<sub>3</sub>**.

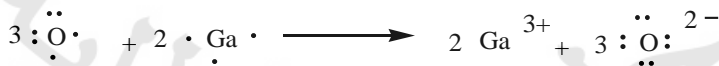

c) Magnesium loses 2 electrons to achieve a noble gas configuration:

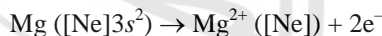

Nitrogen gains 3 electrons to achieve a noble gas configuration:

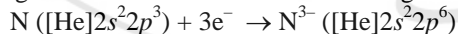

Two N atoms gain the six electrons lost by three Mg atoms. The ionic compound formed is **Mg<sub>3</sub>N<sub>2</sub>**.

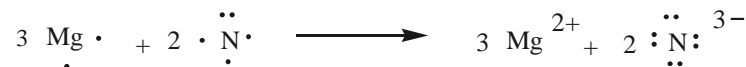

d) Lithium loses 1 electron to achieve a noble gas configuration:

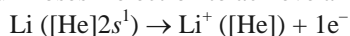

Bromine gains 1 electron to achieve a noble gas configuration:

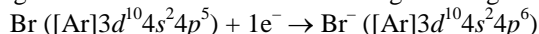

One Br atoms gains the one electron lost by one Li atom. The ionic compound formed is **LiBr**.

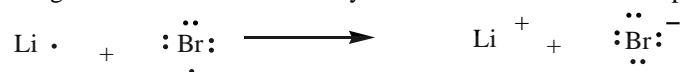

- 9.18 **Plan:** Find the charge of the known atom and use that charge to find the ionic charge of element X. For A-group cations, ion charge = the group number; for anions, ion charge = the group number – 8. Once the ion charge of X is known, the group number can be determined.

**Solution:**

- a) X in  $\text{X}_2\text{O}_3$  is a cation with +3 charge. The oxygen in this compound has a –2 charge. To produce an electrically neutral compound, 2 cations with +3 charge bond with 3 anions with –2 charge:  $2(+3) + 3(-2) = 0$ . Elements in **Group 3A(13)** form +3 ions.  
 b) The carbonate ion,  $\text{CO}_3^{2-}$ , has a –2 charge, so X has a +2 charge. **Group 2A(2)** elements form +2 ions.  
 c) X in  $\text{Na}_2\text{X}$  has a –2 charge, balanced with the +2 overall charge from the two  $\text{Na}^+$  ions. **Group 6A(16)** elements gain 2 electrons to form –2 ions with a noble gas configuration.
- 9.19 a) **7A(17)**      b) **6A(16)**      c) **3A(13)**

- 9.20 **Plan:** The magnitude of the lattice energy depends on ionic size and ionic charge. For a particular arrangement of ions, the lattice energy increases as the charges on the ions increase and as their radii decrease.

**Solution:**

- a) **BaS** has the lower lattice energy because the ionic radius of  $\text{Ba}^{2+}$  is larger than  $\text{Ca}^{2+}$ . A larger ionic radius results in a greater distance between ions. The lattice energy decreases with increasing distance between ions.  
 b) **NaF** has the lower lattice energy since the charge on each ion (+1, –1) is half the charge on the  $\text{Mg}^{2+}$  and  $\text{O}^{2-}$  ions. Lattice energy increases with increasing ion charge.
- 9.21 a) **NaCl**; Cl has a larger radius than F.  
 b) **K<sub>2</sub>S**; S has a larger radius than O.

- 9.22 The lattice energy in an ionic solid is directly proportional to the product of the ion charges and inversely proportional to the sum of the ion radii. The strong interactions between ions cause most ionic materials to be hard. A very large lattice energy implies a very hard material. The lattice energy is predicted to be high for  $\text{Al}_2\text{O}_3$  since the ions involved,  $\text{Al}^{3+}$  and  $\text{O}^{2-}$ , have fairly large charges and are relatively small ions.

- 9.23 When two chlorine atoms are far apart, there is no interaction between them. Once the two atoms move closer together, the nucleus of each atom attracts the electrons on the other atom. As the atoms move closer this attraction increases, but the repulsion of the two nuclei also increases. When the atoms are very close together the repulsion between nuclei is much stronger than the attraction between nuclei and electrons. The final internuclear distance for the chlorine molecule is the distance at which maximum attraction is achieved in spite of the repulsion. At this distance, the energy of the molecule is at its lowest value.

- 9.24 The bond energy is the energy required to overcome the attraction between H atoms and Cl atoms in one mole of HCl molecules in the gaseous state. Energy input is needed to break bonds, so bond energy is always absorbed (endothermic) and  $\Delta H^\circ_{\text{bond breaking}}$  is positive. The same amount of energy needed to break the bond is released upon its formation, so  $\Delta H^\circ_{\text{bond forming}}$  has the same magnitude as  $\Delta H^\circ_{\text{bond breaking}}$ , but opposite in sign (always exothermic and negative).

- 9.25 The strength of the covalent bond is generally inversely related to the size of the bonded atoms. The bonding orbitals in larger atoms are more diffuse, so they form weaker bonds.

- 9.26 Bond strength increases with bond order, so  $C\equiv C > C=C > C-C$ . Two nuclei are more strongly attracted to two shared electron pairs than to one shared electron pair and to three shared electron pairs than to two. The atoms are drawn closer together with more electron pairs in the bond and the bond is stronger.
- 9.27 When benzene boils, the gas consists of  $C_6H_6$  molecules. The energy supplied disrupts the intermolecular attractions between molecules but not the intramolecular forces of bonding within the molecule.
- 9.28 Plan: Bond strength increases as the atomic radii of atoms in the bond decrease; bond strength also increases as bond order increases.  
Solution:  
 a)  $I-I < Br-Br < Cl-Cl$ . Atomic radii decrease up a group in the periodic table, so I is the largest and Cl is the smallest of the three.  
 b)  $S-Br < S-Cl < S-H$ . H has the smallest radius and Br has the largest, so the bond strength for S-H is the greatest and that for S-Br is the weakest.  
 c)  $C-N < C=N < C\equiv N$ . Bond strength increases as the number of electrons in the bond increases. The triple bond is the strongest and the single bond is the weakest.
- 9.29 a)  $H-F < H-Cl < H-I$   
 b)  $C=O < C-O < C-S$   
 c)  $N-H < N-O < N-S$
- 9.30 Plan: Bond strength increases as the atomic radii of atoms in the bond decrease; bond strength also increases as bond order increases.  
Solution:  
 a) The C=O bond (bond order = 2) is stronger than the C-O bond (bond order = 1).  
 b) O is smaller than C so the O-H bond is shorter and stronger than the C-H bond.
- 9.31  $C\equiv C$  is a stronger bond than  $C=C$  since it has a higher bond order. Since the bond energy is greater, the absorption of IR would occur at shorter wavelength since shorter wavelength has more energy.
- 9.32  $H_2(g) + O_2(g) \rightarrow H-O-O-H(g)$   
 $\Delta H_{rxn}^\circ = \Sigma \Delta H_{bonds\ broken}^\circ + \Sigma \Delta H_{bonds\ formed}^\circ$   
 $\Delta H_{rxn}^\circ = BE_{H_2} + BE_{O=O} + [2(BE_{OH}) + BE_{O-O}]$  Use negative values for the bond energies of the products.
- 9.33 Reaction between molecules requires the breaking of existing bonds and the formation of new bonds. Substances with weak bonds are more reactive than are those with strong bonds because less energy is required to break weak bonds.
- 9.34 Bond energies are average values for a particular bond in a variety of compounds. Heats of formation are specific for a compound.
- 9.35 Plan: Write the combustion reactions of methane and of formaldehyde. The reactants requiring the smaller amount of energy to break bonds will have the greater heat of reaction. Examine the bonds in the reactant molecules that will be broken. In general, more energy is required to break double bonds than to break single bonds.  
Solution:  
 For methane:  $CH_4(g) + 2O_2(g) \rightarrow CO_2(g) + 2H_2O(l)$  which requires that 4 C-H bonds and 2 O=O bonds be broken and 2 C=O bonds and 4 O-H bonds be formed.  
 For formaldehyde:  $CH_2O(g) + O_2(g) \rightarrow CO_2(g) + H_2O(l)$  which requires that 2 C-H bonds, 1 C=O bond, and 1 O=O bond be broken and 2 C=O bonds and 2 O-H bonds be formed.



Methane contains more C–H bonds and fewer C=O bonds than formaldehyde. Since C–H bonds take less energy to break than C=O bonds, more energy is released in the combustion of methane than of formaldehyde.

- 9.36 Plan: To find the heat of reaction, add the energy required to break all the bonds in the reactants to the energy released to form all bonds in the product. Remember to use a negative sign for the energy of the bonds formed since bond formation is exothermic. The bond energy values are found in Table 9.2.

Solution:

Reactant bonds broken:

$$1 \times \text{C}=\text{C} = (1 \text{ mol})(614 \text{ kJ/mol}) = 614 \text{ kJ}$$

$$4 \times \text{C}-\text{H} = (4 \text{ mol})(413 \text{ kJ/mol}) = 1652 \text{ kJ}$$

$$1 \times \text{Cl}-\text{Cl} = (1 \text{ mol})(243 \text{ kJ/mol}) = 243 \text{ kJ}$$

$$\Sigma \Delta H_{\text{bonds broken}}^{\circ} = 2509 \text{ kJ}$$

Product bonds formed:

$$1 \times \text{C}-\text{C} = (1 \text{ mol})(-347 \text{ kJ/mol}) = -347 \text{ kJ}$$

$$4 \times \text{C}-\text{H} = (4 \text{ mol})(-413 \text{ kJ/mol}) = -1652 \text{ kJ}$$

$$2 \times \text{C}-\text{Cl} = (2 \text{ mol})(-339 \text{ kJ/mol}) = -678 \text{ kJ}$$

$$\Sigma \Delta H_{\text{bonds formed}}^{\circ} = -2677 \text{ kJ}$$

$$\Delta H_{\text{rxn}}^{\circ} = \Sigma \Delta H_{\text{bonds broken}}^{\circ} + \Sigma \Delta H_{\text{bonds formed}}^{\circ} = 2509 \text{ kJ} + (-2677 \text{ kJ}) = \mathbf{-168 \text{ kJ}}$$

- 9.37  $\text{CO}_2 + 2\text{NH}_3 \rightarrow (\text{H}_2\text{N})_2\text{CO} + \text{H}_2\text{O}$

$$\Delta H_{\text{rxn}}^{\circ} = \Sigma \Delta H_{\text{bonds broken}}^{\circ} + \Sigma \Delta H_{\text{bonds formed}}^{\circ}$$

$$\Delta H_{\text{rxn}}^{\circ} = [(2 \text{ mol } \text{BE}_{\text{C}=\text{O}} + 6 \text{ BE}_{\text{N}-\text{H}})] + [4 (\text{BE}_{\text{N}-\text{H}}) + (\text{BE}_{\text{C}=\text{O}}) + 2 (\text{BE}_{\text{C}-\text{N}}) + 2 (\text{BE}_{\text{O}-\text{H}})]$$

$$= [2 \text{ mol}(799 \text{ kJ/mol}) + 6 \text{ mol}(391 \text{ kJ/mol})] +$$

$$[4 \text{ mol}(-391 \text{ kJ/mol}) + 1 \text{ mol}(-745 \text{ kJ/mol}) + 2 \text{ mol}(-305 \text{ kJ/mol}) + 2 \text{ mol}(-467 \text{ kJ/mol})]$$

$$= 3944 \text{ kJ} + (-3853 \text{ kJ})$$

$$= \mathbf{91 \text{ kJ}}$$

- 9.38 Plan: To find the heat of reaction, add the energy required to break all the bonds in the reactants to the energy released to form all bonds in the product. Remember to use a negative sign for the energy of the bonds formed since bond formation is exothermic. The bond energy values are found in Table 9.2.

Solution:

The reaction:

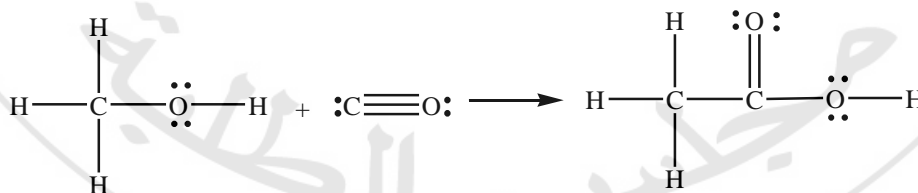

Reactant bonds broken:

$$1 \times \text{C}-\text{O} = (1 \text{ mol})(358 \text{ kJ/mol}) = 358 \text{ kJ}$$

$$3 \times \text{C}-\text{H} = (3 \text{ mol})(413 \text{ kJ/mol}) = 1239 \text{ kJ}$$

$$1 \times \text{O}-\text{H} = (1 \text{ mol})(467 \text{ kJ/mol}) = 467 \text{ kJ}$$

$$1 \times \text{C}\equiv\text{O} = (1 \text{ mol})(1070 \text{ kJ/mol}) = 1070 \text{ kJ}$$

$$\Sigma \Delta H_{\text{bonds broken}}^{\circ} = 3134 \text{ kJ}$$

Product bonds formed:

$$\begin{aligned} 3 \times \text{C-H} &= (3 \text{ mol})(-413 \text{ kJ/mol}) = -1239 \text{ kJ} \\ 1 \times \text{C-C} &= (1 \text{ mol})(-347 \text{ kJ/mol}) = -347 \text{ kJ} \\ 1 \times \text{C=O} &= (1 \text{ mol})(-745 \text{ kJ/mol}) = -745 \text{ kJ} \\ 1 \times \text{C-O} &= (1 \text{ mol})(-358 \text{ kJ/mol}) = -358 \text{ kJ} \\ 1 \times \text{O-H} &= (1 \text{ mol})(-467 \text{ kJ/mol}) = -467 \text{ kJ} \end{aligned}$$

$$\Sigma \Delta H_{\text{bonds formed}}^{\circ} = -3156 \text{ kJ}$$

$$\Delta H_{\text{rxn}}^{\circ} = \Sigma \Delta H_{\text{bonds broken}}^{\circ} + \Sigma \Delta H_{\text{bonds formed}}^{\circ} = 3134 \text{ kJ} + (-3156 \text{ kJ}) = -22 \text{ kJ}$$

- 9.39 **Plan:** To find the heat of reaction, add the energy required to break all the bonds in the reactants to the energy released to form all bonds in the product. Remember to use a negative sign for the energy of the bonds formed since bond formation is exothermic. The bond energy values are found in Table 9.2.

**Solution:**

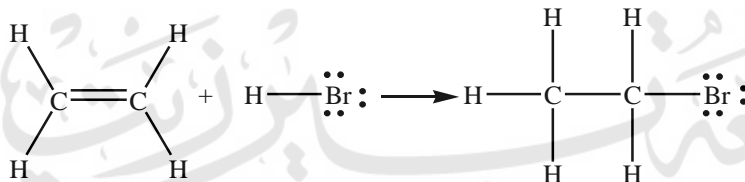

Reactant bonds broken:

$$\begin{aligned} 1 \times \text{C=C} &= (1 \text{ mol})(614 \text{ kJ/mol}) = 614 \text{ kJ} \\ 4 \times \text{C-H} &= (4 \text{ mol})(413 \text{ kJ/mol}) = 1652 \text{ kJ} \\ 1 \times \text{H-Br} &= (1 \text{ mol})(363 \text{ kJ/mol}) = 363 \text{ kJ} \end{aligned}$$

$$\Sigma \Delta H_{\text{bonds broken}}^{\circ} = 2629 \text{ kJ}$$

Product bonds formed:

$$\begin{aligned} 5 \times \text{C-H} &= (5 \text{ mol})(-413 \text{ kJ/mol}) = -2065 \text{ kJ} \\ 1 \times \text{C-C} &= (1 \text{ mol})(-347 \text{ kJ/mol}) = -347 \text{ kJ} \\ 1 \times \text{C-Br} &= (1 \text{ mol})(-276 \text{ kJ/mol}) = -276 \text{ kJ} \end{aligned}$$

$$\Sigma \Delta H_{\text{bonds formed}}^{\circ} = -2688 \text{ kJ}$$

$$\Delta H_{\text{rxn}}^{\circ} = \Sigma \Delta H_{\text{bonds broken}}^{\circ} + \Sigma \Delta H_{\text{bonds formed}}^{\circ} = 2629 \text{ kJ} + (-2688 \text{ kJ}) = -59 \text{ kJ}$$

- 9.40 Electronegativity increases from left to right across a period (except for the noble gases) and increases from bottom to top within a group. Fluorine (F) and oxygen (O) are the two most electronegative elements. Cesium (Cs) and francium (Fr) are the two least electronegative elements.
- 9.41 In general, electronegativity and ionization energies are directly related. Electronegativity relates the strength with which an atom attracts bonding electrons and the ionization energy measures the energy needed to remove an electron. Atoms that do not require much energy to have an electron removed do not have much attraction for bonding electrons.
- 9.42 Ionic bonds occur between two elements of very different electronegativity, generally a metal with low electronegativity and a nonmetal with high electronegativity. Although electron sharing occurs to a very small extent in some ionic bonds, the primary force in ionic bonds is attraction of opposite charges resulting from electron transfer between the atoms. A nonpolar covalent bond occurs between two atoms with identical electronegativity values where the sharing of bonding electrons is equal. A polar covalent bond is between two atoms (generally nonmetals) of different electronegativities so that the bonding electrons are unequally shared. The H-O bond in water is **polar covalent**. The bond is between two nonmetals so it is covalent and not ionic, but atoms with different electronegativity values are involved.

9.43 Electronegativity is the tendency of a bonded atom to hold the bonding electrons more strongly. Electron affinity is the energy involved when an atom acquires an electron.

9.44 The difference in EN is a reflection of how strongly one atom in a bond attracts bonding electrons. The greater this difference is, the more likely the bond will be ionic (higher partial ionic character); the smaller the EN difference, the more covalent (lower partial ionic character) the bond.

9.45 Plan: Electronegativity increases from left to right across a period (except for the noble gases) and increases from bottom to top within a group.

Solution:

a)  $\text{Si} < \text{S} < \text{O}$ , sulfur is more electronegative than silicon since it is located further to the right in the table. Oxygen is more electronegative than sulfur since it is located nearer the top of the table.

b)  $\text{Mg} < \text{As} < \text{P}$ , magnesium is the least electronegative because it lies on the left side of the periodic table and phosphorus and arsenic on the right side. Phosphorus is more electronegative than arsenic because it is higher in the table.

9.46 a)  $\text{I} < \text{Br} < \text{N}$

b)  $\text{Ca} < \text{H} < \text{F}$

9.47 Plan: The polar arrow points toward the more electronegative atom. Electronegativity increases from left to right across a period (except for the noble gases) and increases from bottom to top within a group.

Solution:

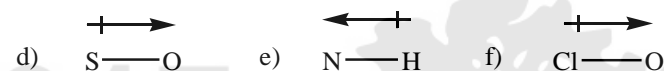
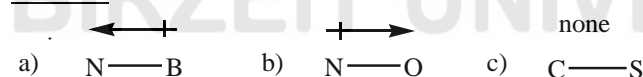

9.48 The more electronegative element is partially negative ( $\delta^-$ ) and the less electronegative element is partially positive ( $\delta^+$ ).

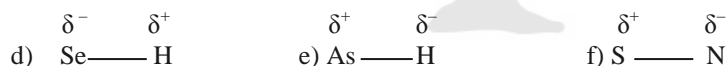

9.49 Plan: The more polar bond will have a greater difference in electronegativity,  $\Delta\text{EN}$ .

Solution:

a) N: EN = 3.0; B: EN = 2.0;  $\Delta\text{EN}_a = 3.0 - 2.0 = 1.0$

b) N: EN = 3.0; O: EN = 3.5;  $\Delta\text{EN}_b = 3.5 - 3.0 = 0.5$

c) C: EN = 2.5; S: EN = 2.5;  $\Delta\text{EN}_c = 2.5 - 2.5 = 0$

d) S: EN = 2.5; O: EN = 3.5;  $\Delta\text{EN}_d = 3.5 - 2.5 = 1.0$

e) N: EN = 3.0; H: EN = 2.1;  $\Delta\text{EN}_e = 3.0 - 2.1 = 0.9$

f) Cl: EN = 3.0; O: EN = 3.5;  $\Delta\text{EN}_f = 3.5 - 3.0 = 0.5$

**(a), (d), and (e)** have greater bond polarity.

9.50 **b)** is more polar;  $\Delta\text{EN}$  is 1.0 for F–Cl and 0.2 for Br–Cl

**c)** is more polar;  $\Delta\text{EN}$  is 1.4 for H–O and 0.3 for Se–H

**f)** is more polar;  $\Delta\text{EN}$  is 0.5 for S–N and 0.1 for As–H

- 9.51 Plan: Ionic bonds occur between two elements of very different electronegativity, generally a metal with low electronegativity and a nonmetal with high electronegativity. Although electron sharing occurs to a very small extent in some ionic bonds, the primary force in ionic bonds is attraction of opposite charges resulting from electron transfer between the atoms. A nonpolar covalent bond occurs between two atoms with identical electronegativity values where the sharing of bonding electrons is equal. A polar covalent bond is between two atoms (generally nonmetals) of different electronegativities so that the bonding electrons are unequally shared. For polar covalent bonds, the larger the  $\Delta EN$ , the more polar the bond.

Solution:

- a) Bonds in  $S_8$  are **nonpolar covalent**. All the atoms are nonmetals so the substance is covalent and bonds are nonpolar because all the atoms are of the same element and thus have the same electronegativity value.  $\Delta EN = 0$ .
- b) Bonds in  $RbCl$  are **ionic** because  $Rb$  is a metal and  $Cl$  is a nonmetal.  $\Delta EN$  is large.
- c) Bonds in  $PF_3$  are **polar covalent**. All the atoms are nonmetals so the substance is covalent. The bonds between  $P$  and  $F$  are polar because their electronegativity differs (by 1.9 units for  $P-F$ ).
- d) Bonds in  $SCl_2$  are **polar covalent**.  $S$  and  $Cl$  are nonmetals and differ in electronegativity (by 0.5 unit for  $S-Cl$ ).
- e) Bonds in  $F_2$  are **nonpolar covalent**.  $F$  is a nonmetal. Bonds between two atoms of the same element are nonpolar since  $\Delta EN = 0$ .
- f) Bonds in  $SF_2$  are **polar covalent**.  $S$  and  $F$  are nonmetals that differ in electronegativity (by 1.5 units for  $S-F$ ).

**Increasing bond polarity:  $SCl_2 < SF_2 < PF_3$**

- 9.52 a)  $KCl$  **ionic**      b)  $P_4$  **nonpolar covalent**      c)  $BF_3$  **polar covalent**  
 d)  $SO_2$  **polar covalent**      e)  $Br_2$  **nonpolar covalent**      f)  $NO_2$  **polar covalent**  
 **$NO_2 < SO_2 < BF_3$**

- 9.53 Plan: Increasing ionic character occurs with increasing  $\Delta EN$ . Electronegativity increases from left to right across a period (except for the noble gases) and increases from bottom to top within a group. The polar arrow points toward the more electronegative atom.

Solution:

- a)  $H$ :  $EN = 2.1$ ;  $Cl$ :  $EN = 3.0$ ;  $Br$ :  $EN = 2.8$ ;  $I$ :  $EN = 2.5$   
 $\Delta EN_{HBr} = 2.8 - 2.1 = 0.7$ ;  $\Delta EN_{HCl} = 3.0 - 2.1 = 0.9$ ;  $\Delta EN_{HI} = 2.5 - 2.1 = 0.4$
- b)  $H$ :  $EN = 2.1$ ;  $O$ :  $EN = 3.5$ ;  $C$ :  $EN = 2.5$ ;  $F$ :  $EN = 4.0$   
 $\Delta EN_{HO} = 3.5 - 2.1 = 1.4$ ;  $\Delta EN_{CH} = 2.5 - 2.1 = 0.4$ ;  $\Delta EN_{HF} = 4.0 - 2.1 = 1.9$
- c)  $Cl$ :  $EN = 3.0$ ;  $S$ :  $EN = 2.5$ ;  $P$ :  $EN = 2.1$ ;  $Si$ :  $EN = 1.8$   
 $\Delta EN_{SCl} = 3.0 - 2.5 = 0.5$ ;  $\Delta EN_{PCl} = 3.0 - 2.1 = 0.9$ ;  $\Delta EN_{SiCl} = 3.0 - 1.8 = 1.2$

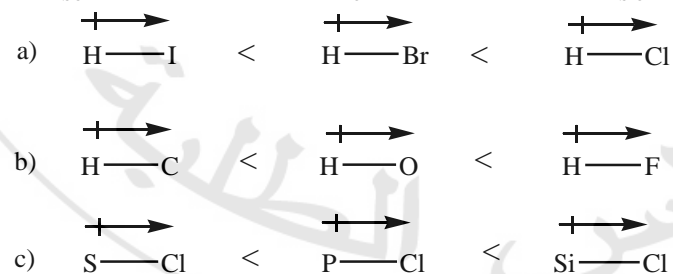

- 9.54 Increasing ionic character occurs with increasing  $\Delta EN$ .

- a)  $\Delta EN_{PCl} = 0.9$ ,  $\Delta EN_{PBr} = 0.7$ ,  $\Delta EN_{PF} = 1.9$        $P-F > P-Cl > P-Br$
- b)  $\Delta EN_{BF} = 2.0$ ,  $\Delta EN_{NF} = 1.0$ ,  $\Delta EN_{CF} = 1.5$        $B-F > C-F > N-F$
- c)  $\Delta EN_{SeF} = 1.6$ ,  $\Delta EN_{TeF} = 1.9$ ,  $\Delta EN_{BrF} = 1.2$        $Te-F > Se-F > Br-F$
- $\delta+ \delta- \quad \delta+ \delta- \quad \delta+ \delta-$   
 $\delta+ \delta- \quad \delta+ \delta- \quad \delta+ \delta-$   
 $\delta+ \delta- \quad \delta+ \delta- \quad \delta+ \delta-$

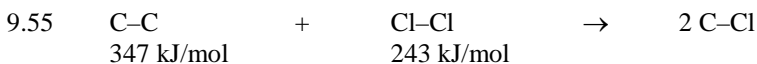

d) The value should be greater than the average of the two bond energies given. This is due to the electronegativity difference.

9.56 Molten rock cools from top to bottom. The most stable compound (the one with the largest lattice energy) will solidify first near the top. The less stable compounds will remain in the molten state at the bottom and eventually crystallize there later.

9.57 Plan: Write a balanced chemical reaction. The given heat of reaction is the sum of the energy required to break all the bonds in the reactants and the energy released to form all bonds in the product. Remember to use a negative sign for the energy of the bonds formed since bond formation is exothermic. The bond energy values are found in Table 9.2. Use the ratios from the balanced reaction between the heat of reaction and acetylene and between acetylene and  $\text{CO}_2$  and  $\text{O}_2$  to find the amounts needed. The ideal gas law is used to convert from moles of oxygen to volume of oxygen.

Solution:

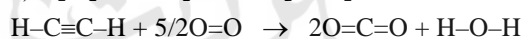

$$\Delta H_{\text{rxn}}^\circ = \Sigma \Delta H_{\text{bonds broken}}^\circ + \Sigma \Delta H_{\text{bonds formed}}^\circ$$

$$\Delta H_{\text{rxn}}^\circ = [2 \text{BE}_{\text{C-H}} + \text{BE}_{\text{C}\equiv\text{C}} + 5/2 \text{BE}_{\text{O}=\text{O}}] + [4(-\text{BE}_{\text{C}=\text{O}}) + 2(-\text{BE}_{\text{O-H}})]$$

$$-1259 \text{ kJ} = [2(413) + \text{BE}_{\text{C}\equiv\text{C}} + 5/2(498)] + [4(-799) + 2(-467)]$$

$$-1259 \text{ kJ} = [826 + \text{BE}_{\text{C}\equiv\text{C}} + 1245] + [-4130] \text{ kJ}$$

$$-1259 \text{ kJ} = -2059 + \text{BE}_{\text{C}\equiv\text{C}} \text{ kJ}$$

$$\text{BE}_{\text{C}\equiv\text{C}} = \mathbf{800. \text{ kJ/mol}}$$

Table 9.2 lists the value as 839 kJ/mol.

$$\text{b) Heat (kJ)} = (500.0 \text{ g C}_2\text{H}_2) \left( \frac{1 \text{ mol C}_2\text{H}_2}{26.04 \text{ g C}_2\text{H}_2} \right) \left( \frac{-1259 \text{ kJ}}{1 \text{ mol C}_2\text{H}_2} \right)$$

$$= -2.4174347 \times 10^4 = \mathbf{-2.417 \times 10^4 \text{ kJ}}$$

$$\text{c) Mass (g) of CO}_2 = (500.0 \text{ g C}_2\text{H}_2) \left( \frac{1 \text{ mol C}_2\text{H}_2}{26.04 \text{ g C}_2\text{H}_2} \right) \left( \frac{2 \text{ mol CO}_2}{1 \text{ mol C}_2\text{H}_2} \right) \left( \frac{44.01 \text{ g CO}_2}{1 \text{ mol CO}_2} \right)$$

$$= 1690.092 = \mathbf{1690. \text{ g CO}_2}$$

$$\text{d) Amount (mol) of O}_2 = (500.0 \text{ g C}_2\text{H}_2) \left( \frac{1 \text{ mol C}_2\text{H}_2}{26.04 \text{ g C}_2\text{H}_2} \right) \left( \frac{5/2 \text{ mol O}_2}{1 \text{ mol C}_2\text{H}_2} \right)$$

$$= 48.0030722 \text{ mol O}_2$$

$$PV = nRT$$

$$\text{Volume (L) of O}_2 = \frac{nRT}{P} = \frac{(48.0030722 \text{ mol O}_2) \left( 0.08206 \frac{\text{L} \cdot \text{atm}}{\text{mol} \cdot \text{K}} \right) (298 \text{ K})}{18.0 \text{ atm}}$$

$$= 65.2145 = \mathbf{65.2 \text{ L O}_2}$$

9.58 Plan: The heat of formation of  $\text{MgCl}$  is represented by the equation  $\text{Mg}(s) + 1/2\text{Cl}_2(g) \rightarrow \text{MgCl}(s)$ . Use Hess's law and arrange the given equations so that they sum up to give the equation for the heat of formation of  $\text{MgCl}$ . You will need to multiply the second equation by  $1/2$ ; you will need to reverse the equation for the lattice energy [ $\text{MgCl}(s) \rightarrow \text{Mg}^+(g) + \text{Cl}^-(g)$ ] and change the sign of the given lattice energy value. Negative heats of formation are energetically favored.

**Solution:**

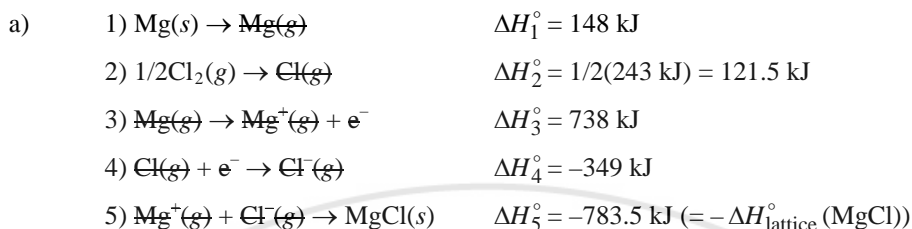

$$\begin{aligned} \Delta H_f^\circ(\text{MgCl}) &= \Delta H_1^\circ + \Delta H_2^\circ + \Delta H_3^\circ + \Delta H_4^\circ + \Delta H_5^\circ \\ &= 148 \text{ kJ} + 121.5 \text{ kJ} + 738 \text{ kJ} + (-349 \text{ kJ}) + (-783.5 \text{ kJ}) = \mathbf{-125 \text{ kJ}} \end{aligned}$$

b) **Yes**, since  $\Delta H_f^\circ$  for MgCl is negative, MgCl(s) is stable relative to its elements.



$$\Delta H_{\text{rxn}}^\circ = \Delta H_{\text{rxn}}^\circ = \sum m \Delta H_f^\circ(\text{products}) - \sum n \Delta H_f^\circ(\text{reactants})$$

$$\Delta H_{\text{rxn}}^\circ = \{1 \Delta H_f^\circ[\text{MgCl}_2(s)] + 1 \Delta H_f^\circ[\text{Mg}(s)]\} - \{2 \Delta H_f^\circ[\text{MgCl}(s)]\}$$

$$\Delta H_{\text{rxn}}^\circ = [1 \text{ mol}(-641.6 \text{ kJ/mol}) + 1 \text{ mol}(0)] - [2 \text{ mol}(-125 \text{ kJ/mol})]$$

$$\Delta H_{\text{rxn}}^\circ = -391.6 = \mathbf{-392 \text{ kJ}}$$

d) **No**,  $\Delta H_f^\circ$  for MgCl<sub>2</sub> is much more negative than that for MgCl. This makes the  $\Delta H_{\text{rxn}}^\circ$  value for the above reaction very negative, and the formation of MgCl<sub>2</sub> would be favored.

9.59 **Plan:** Find the bond energy for an H–I bond from Table 9.2. For part a), calculate the wavelength with this energy using the relationship from Chapter 7:  $E = hc/\lambda$ . For part b), calculate the energy for a wavelength of 254 nm and then subtract the energy from part a) to get the excess energy. For part c), speed can be calculated from the excess energy since  $E_k = 1/2mu^2$ .

**Solution:**

a) Bond energy for H–I is 295 kJ/mol (Table 9.2).

$$\text{Bond energy (J/photon)} = \left(\frac{295 \text{ kJ}}{\text{mol}}\right) \left(\frac{10^3 \text{ J}}{1 \text{ kJ}}\right) \left(\frac{1 \text{ mol}}{6.022 \times 10^{23} \text{ photons}}\right) = 4.898705 \times 10^{-19} \text{ J/photon}$$

$$E = hc/\lambda$$

$$\lambda \text{ (m)} = hc/E = \frac{(6.626 \times 10^{-34} \text{ J}\cdot\text{s})(3.00 \times 10^8 \text{ m/s})}{(4.898705 \times 10^{-19} \text{ J})} = 4.057807 \times 10^{-7} \text{ m}$$

$$\lambda \text{ (nm)} = (4.057807 \times 10^{-7} \text{ m}) \left(\frac{1 \text{ nm}}{10^{-9} \text{ m}}\right) = 405.7807 = \mathbf{406 \text{ nm}}$$

b)  $E(\text{HI}) = 4.898705 \times 10^{-19} \text{ J}$

$$E(254 \text{ nm}) = hc/\lambda = \frac{(6.626 \times 10^{-34} \text{ J}\cdot\text{s})(3.00 \times 10^8 \text{ m/s})}{254 \text{ nm}} \left(\frac{1 \text{ nm}}{10^{-9} \text{ m}}\right) = 7.82598 \times 10^{-19} \text{ J}$$

$$\text{Excess energy} = 7.82598 \times 10^{-19} \text{ J} - 4.898705 \times 10^{-19} \text{ J} = 2.92728 \times 10^{-19} = \mathbf{2.93 \times 10^{-19} \text{ J}}$$

c) Mass (kg) of H =  $\left(\frac{1.008 \text{ g H}}{\text{mol}}\right) \left(\frac{\text{mol}}{6.022 \times 10^{23}}\right) \left(\frac{1 \text{ kg}}{10^3 \text{ g}}\right) = 1.67386 \times 10^{-27} \text{ kg}$

$$E_k = 1/2mu^2 \text{ thus, } u = \sqrt{\frac{2E}{m}}$$

$$u = \sqrt{\frac{2(2.92728 \times 10^{-19} \text{ J})}{1.67386 \times 10^{-27} \text{ kg}} \left(\frac{\text{kg}\cdot\text{m}^2/\text{s}^2}{\text{J}}\right)} = 1.8701965 \times 10^4 = \mathbf{1.87 \times 10^4 \text{ m/s}}$$

- 9.60 a) Vibrational motions have frequencies which are in the **IR region** of the electromagnetic spectrum.  
 b)  $E = h\nu = (6.626 \times 10^{-34} \text{ J}\cdot\text{s})(4.02 \times 10^{13} \text{ s}^{-1}) = 2.66365 \times 10^{-20} = \mathbf{2.66 \times 10^{-20} \text{ J}}$  (symmetric stretch)  
 $E = (6.626 \times 10^{-34} \text{ J}\cdot\text{s})(2.00 \times 10^{13} \text{ s}^{-1}) = 1.3252 \times 10^{-20} = \mathbf{1.33 \times 10^{-20} \text{ J}}$  (bending)  
 $E = (6.626 \times 10^{-34} \text{ J}\cdot\text{s})(7.05 \times 10^{13} \text{ s}^{-1}) = 4.6713 \times 10^{-20} = \mathbf{4.67 \times 10^{-20} \text{ J}}$  (asymmetrical stretch)

**Bending requires the least amount of energy.**

- 9.61 “Excess bond energy” refers to the difference between the actual bond energy for an X–Y bond and the average of the energies for the X–X and the Y–Y bonds.

$$\text{Excess bond energy} = BE_{X-Y} - 1/2 (BE_{X-X} + BE_{Y-Y}).$$

The excess bond energy is zero when the atoms X and Y are identical or have the same electronegativity, as in **(a), (b), and (e)**.

$$\Delta EN_{PH} = 0, \Delta EN_{CS} = 0, \Delta EN_{BrCl} = 0.2, \Delta EN_{BH} = 0.1, \Delta EN_{SeSe} = 0$$

- 9.62 Plan: Find the appropriate bond energies in Table 9.2. Calculate the wavelengths using  $E = hc/\lambda$ .

Solution:

C–Cl bond energy = 339 kJ/mol

$$\text{Bond energy (J/photon)} = \left( \frac{339 \text{ kJ}}{\text{mol}} \right) \left( \frac{10^3 \text{ J}}{1 \text{ kJ}} \right) \left( \frac{1 \text{ mol}}{6.022 \times 10^{23} \text{ photons}} \right) = 5.62936 \times 10^{-19} \text{ J/photon}$$

$$E = hc/\lambda$$

$$\lambda \text{ (m)} = hc/E = \frac{(6.626 \times 10^{-34} \text{ J}\cdot\text{s})(3.00 \times 10^8 \text{ m/s})}{(5.62936 \times 10^{-19} \text{ J})} = 3.5311296 \times 10^{-7} = \mathbf{3.53 \times 10^{-7} \text{ m}}$$

O<sub>2</sub> bond energy = 498 kJ/mol

$$\text{Bond energy (J/photon)} = \left( \frac{498 \text{ kJ}}{\text{mol}} \right) \left( \frac{10^3 \text{ J}}{1 \text{ kJ}} \right) \left( \frac{1 \text{ mol}}{6.022 \times 10^{23} \text{ photons}} \right) = 8.269678 \times 10^{-19} \text{ J/photon}$$

$$E = hc/\lambda$$

$$\lambda \text{ (m)} = hc/E = \frac{(6.626 \times 10^{-34} \text{ J}\cdot\text{s})(3.00 \times 10^8 \text{ m/s})}{(8.269678 \times 10^{-19} \text{ J})} = 2.40372 \times 10^{-7} = \mathbf{2.40 \times 10^{-7} \text{ m}}$$

- 9.63 Plan: Write balanced chemical equations for the formation of each of the compounds. Obtain the bond energy of fluorine from Table 9.2 (159 kJ/mol). Determine the average bond energy from  $\Delta H = \text{bonds broken} + \text{bonds formed}$ . Remember that the bonds formed (Xe–F) have negative values since bond formation is exothermic.

Solution:

$$\Delta H_{\text{rxn}}^{\circ} = \Sigma \Delta H_{\text{bonds broken}}^{\circ} + \Sigma \Delta H_{\text{bonds formed}}^{\circ}$$



$$\Delta H_{\text{rxn}}^{\circ} = -105 \text{ kJ/mol} = [1 \text{ mol F}_2 (159 \text{ kJ/mol})] + [2 (-\text{Xe-F})]$$

$$-264 \text{ kJ/mol} = 2 (-\text{Xe-F})$$

$$\text{Xe-F} = \mathbf{132 \text{ kJ/mol}}$$



$$\Delta H_{\text{rxn}}^{\circ} = -284 \text{ kJ/mol} = [2 \text{ mol F}_2 (159 \text{ kJ/mol})] + [4 (-\text{Xe-F})]$$

$$-602 \text{ kJ/mol} = 4 (-\text{Xe-F})$$

$$\text{Xe-F} = 150.5 = \mathbf{150. \text{ kJ/mol}}$$

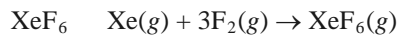

$$\Delta H_{\text{rxn}}^{\circ} = -402 \text{ kJ/mol} = [3 \text{ mol F}_2 (159 \text{ kJ/mol})] + [6 (-\text{Xe-F})]$$

$$-879 \text{ kJ/mol} = 6 (-\text{Xe-F})$$

$$\text{Xe-F} = 146.5 = \mathbf{146 \text{ kJ/mol}}$$

- 9.64 The difference in electronegativity produces a greater than expected overlap of orbitals, which shortens the bond. As  $\Delta EN$  becomes smaller (i.e., as you proceed from HF to HI), this effect lessens and the bond lengths become more predictable.
- 9.65 a) The presence of the very electronegative fluorine atoms bonded to one of the carbon atoms in  $H_3C-CF_3$  makes the C-C bond polar. This polar bond will tend to undergo heterolytic rather than homolytic cleavage. More energy is required to force heterolytic cleavage.  
 b) Since one atom gets both of the bonding electrons in heterolytic bond breakage, this results in the formation of ions. In heterolytic cleavage a cation is formed, involving ionization energy; an anion is also formed, involving electron affinity. The bond energy of the  $O_2$  bond is 498 kJ/mol.  
 $\Delta H = (\text{homolytic cleavage} + \text{electron affinity} + \text{first ionization energy})$   
 $\Delta H = (498/2 \text{ kJ/mol} + (-141 \text{ kJ/mol}) + 1314 \text{ kJ/mol}) = 1422 = \mathbf{1420 \text{ kJ/mol}}$   
 It would require 1420 kJ to heterolytically cleave 1 mol of  $O_2$ .
- 9.66 The bond energies are needed from Table 9.2.  $N_2 = 945 \text{ kJ/mol}$ ;  $O_2 = 498 \text{ kJ/mol}$ ;  $F_2 = 159 \text{ kJ/mol}$

$N_2$ :

$$\lambda = hc/E = \frac{(6.626 \times 10^{-34} \text{ J}\cdot\text{s})(3.00 \times 10^8 \text{ m/s})}{\left(945 \frac{\text{kJ}}{\text{mol}}\right) \left(\frac{10^3 \text{ J}}{1 \text{ kJ}}\right) \left(\frac{\text{mol}}{6.022 \times 10^{23}}\right)} = 1.26672 \times 10^{-7} = \mathbf{1.27 \times 10^{-7} \text{ m}}$$

$O_2$ :

$$\lambda = hc/E = \frac{(6.626 \times 10^{-34} \text{ J}\cdot\text{s})(3.00 \times 10^8 \text{ m/s})}{\left(498 \frac{\text{kJ}}{\text{mol}}\right) \left(\frac{10^3 \text{ J}}{1 \text{ kJ}}\right) \left(\frac{\text{mol}}{6.022 \times 10^{23}}\right)} = 2.40372 \times 10^{-7} = \mathbf{2.40 \times 10^{-7} \text{ m}}$$

$F_2$ :

$$\lambda = hc/E = \frac{(6.626 \times 10^{-34} \text{ J}\cdot\text{s})(3.00 \times 10^8 \text{ m/s})}{\left(159 \frac{\text{kJ}}{\text{mol}}\right) \left(\frac{10^3 \text{ J}}{1 \text{ kJ}}\right) \left(\frac{\text{mol}}{6.022 \times 10^{23}}\right)} = 7.528636 \times 10^{-7} = \mathbf{7.53 \times 10^{-7} \text{ m}}$$

9.67  $\Delta H_{\text{rxn}}^\circ = \Sigma \Delta H_{\text{bonds broken}}^\circ + \Sigma \Delta H_{\text{bonds formed}}^\circ$

For ethane:  $\Delta H_{\text{rxn}}^\circ = [1 \text{ mol} (\text{BE}_{C-C}) + 6 \text{ mol} (\text{BE}_{C-H}) + 1 \text{ mol} (\text{BE}_{H-H})] + [8 \text{ mol} (\text{BE}_{C-H}) - 65.07 \text{ kJ}] = [1 \text{ mol}(347 \text{ kJ/mol}) + 6 \text{ mol} (\text{BE}_{C-H}) + 1 \text{ mol}(432 \text{ kJ/mol})] + [8 \text{ mol}(-415 \text{ kJ/mol})]$

$$\text{BE}_{C-H} = \frac{(-65.07 - 347 - 432 + 3320) \text{ kJ}}{6 \text{ mol}} = 412.655 = \mathbf{413 \text{ kJ/mol}}$$

For ethene:  $\Delta H_{\text{rxn}}^\circ = [1 \text{ mol} (\text{BE}_{C=C}) + 4 \text{ mol} (\text{BE}_{C-H}) + 2 \text{ mol} (\text{BE}_{H-H})] + [8 \text{ mol} (\text{BE}_{C-H}) - 202.21 \text{ kJ}] = [1 \text{ mol}(614 \text{ kJ/mol}) + 4 \text{ mol} (\text{BE}_{C-H}) + 2 \text{ mol}(432 \text{ kJ/mol}) + [8 \text{ mol}(-415 \text{ kJ/mol})]$

$$\text{BE}_{C-H} = \frac{(-202.21 - 614 - 864 + 3320) \text{ kJ}}{4 \text{ mol}} = 409.9475 = \mathbf{410. \text{ kJ/mol}}$$

For ethyne:  $\Delta H_{\text{rxn}}^\circ = [1 \text{ mol} (\text{BE}_{C=C}) + 2 \text{ mol} (\text{BE}_{C-H}) + 3 \text{ mol} (\text{BE}_{H-H})] + [8 \text{ mol} (\text{BE}_{C-H}) - 376.74 \text{ kJ}] = [1 \text{ mol}(839 \text{ kJ/mol}) + 2 \text{ mol} (\text{BE}_{C-H}) + 3 \text{ mol}(432 \text{ kJ/mol}) + [8 \text{ mol}(-415 \text{ kJ/mol})]$

$$\text{BE}_{C-H} = \frac{(-376.74 - 839 - 1296 + 3320) \text{ kJ}}{2 \text{ mol}} = 404.13 = \mathbf{404 \text{ kJ/mol}}$$



- 9.68 **Plan:** Convert the bond energy in kJ/mol to units of J/photon. Use the equations  $E = h\nu$ , and  $E = hc/\lambda$  to find the frequency and wavelength of light associated with this energy.

**Solution:**

$$\text{Bond energy (J/photon)} = \left( \frac{347 \text{ kJ}}{\text{mol}} \right) \left( \frac{10^3 \text{ J}}{1 \text{ kJ}} \right) \left( \frac{1 \text{ mol}}{6.022 \times 10^{23} \text{ photons}} \right) = 5.762205 \times 10^{-19} \text{ J/photon}$$

$$E = h\nu \text{ or } \nu = \frac{E}{h}$$

$$\nu = \frac{E}{h} = \frac{5.762205 \times 10^{-19} \text{ J}}{6.626 \times 10^{-34} \text{ J}\cdot\text{s}} = 8.6963553 \times 10^{14} = \mathbf{8.70 \times 10^{14} \text{ s}^{-1}}$$

$$E = hc/\lambda \text{ or } \lambda = hc/E$$

$$\lambda \text{ (m)} = hc/E = \frac{(6.626 \times 10^{-34} \text{ J}\cdot\text{s})(3.00 \times 10^8 \text{ m/s})}{5.762205 \times 10^{-19} \text{ J}} = 3.44972 \times 10^{-7} = \mathbf{3.45 \times 10^{-7} \text{ m}}$$

This is in the **ultraviolet** region of the electromagnetic spectrum.

$$9.69 \quad \nu = \frac{E}{h} = \frac{\left( \frac{467 \text{ kJ}}{\text{mol}} \right) \left( \frac{10^3 \text{ J}}{1 \text{ kJ}} \right) \left( \frac{\text{mol}}{6.022 \times 10^{23}} \right)}{6.626 \times 10^{-34} \text{ J}\cdot\text{s}} = 1.170374 \times 10^{15} = \mathbf{1.17 \times 10^{15} \text{ s}^{-1}}$$

$$\lambda \text{ (m)} = hc/E = \frac{(6.626 \times 10^{-34} \text{ J}\cdot\text{s})(3.00 \times 10^8 \text{ m/s})}{\left( \frac{467 \text{ kJ}}{\text{mol}} \right) \left( \frac{10^3 \text{ J}}{1 \text{ kJ}} \right) \left( \frac{\text{mol}}{6.022 \times 10^{23}} \right)} = 2.56328 \times 10^{-7} = \mathbf{2.56 \times 10^{-7} \text{ m}}$$

$$E_{\text{photon}} = \left( \frac{467 \text{ kJ}}{\text{mol}} \right) \left( \frac{1 \text{ mol}}{6.022 \times 10^{23} \text{ photons}} \right) = 7.7548987 \times 10^{-22} = \mathbf{7.75 \times 10^{-22} \text{ kJ/photon}}$$

- 9.70 **Plan:** Write the balanced equations for the reactions. Determine the heat of reaction from  $\Delta H = \text{bonds broken} + \text{bonds formed}$ . Remember that the bonds formed have negative values since bond formation is exothermic.

**Solution:**

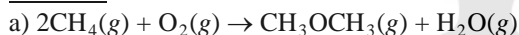

$$\Delta H_{\text{rxn}}^{\circ} = \Sigma \Delta H_{\text{bonds broken}}^{\circ} + \Sigma \Delta H_{\text{bonds formed}}^{\circ}$$

$$\Delta H_{\text{rxn}}^{\circ} = [8 \times (\text{BE}_{\text{C-H}}) + 1 \times (\text{BE}_{\text{O-O}})] + [6 \times (\text{BE}_{\text{C-H}}) + 2 \times (\text{BE}_{\text{C-O}}) + 2 \times (\text{BE}_{\text{O-H}})]$$

$$\Delta H_{\text{rxn}}^{\circ} = [8 \text{ mol}(413 \text{ kJ/mol}) + 1 \text{ mol}(498 \text{ kJ/mol})] + [6 \text{ mol}(-413 \text{ kJ/mol}) + 2 \text{ mol}(-358 \text{ kJ/mol}) + 2 \text{ mol}(-467 \text{ kJ/mol})]$$

$$\Delta H_{\text{rxn}}^{\circ} = \mathbf{-326 \text{ kJ}}$$



$$\Delta H_{\text{rxn}}^{\circ} = \Sigma \Delta H_{\text{bonds broken}}^{\circ} + \Sigma \Delta H_{\text{bonds formed}}^{\circ}$$

$$\Delta H_{\text{rxn}}^{\circ} = [8 \times (\text{BE}_{\text{C-H}}) + 1 \times (\text{BE}_{\text{O-O}})] + [5 \times (\text{BE}_{\text{C-H}}) + 1 \times (\text{BE}_{\text{C-C}}) + 1 \times (\text{BE}_{\text{C-O}}) + 3 \times (\text{BE}_{\text{O-H}})]$$

h)]

$$\Delta H_{\text{rxn}}^{\circ} = [8 \text{ mol}(413 \text{ kJ/mol}) + 1 \text{ mol}(498 \text{ kJ/mol})]$$

$$+ [5 \text{ mol}(-413 \text{ kJ/mol}) + 1 \text{ mol}(-347 \text{ kJ/mol}) + 1 \text{ mol}(-358 \text{ kJ/mol}) + 3 \text{ mol}(-467 \text{ kJ/mol})]$$

$$\Delta H_{\text{rxn}}^{\circ} = \mathbf{-369 \text{ kJ}}$$

- b) The formation of gaseous **ethanol** is more exothermic.

c) The conversion reaction is  $\text{CH}_3\text{CH}_2\text{OH}(g) \rightarrow \text{CH}_3\text{OCH}_3(g)$ .

Use Hess's law:

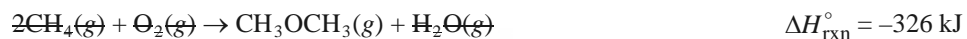
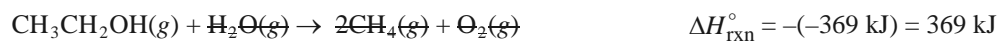

جامعة بيرزيت

BIRZEIT UNIVERSITY

2017



2016

مجلس الطلبة

# CHAPTER 10 THE SHAPES OF MOLECULES

## END-OF-CHAPTER PROBLEMS

10.1 Plan: To be the central atom in a compound, an atom must be able to simultaneously bond to at least two other atoms.

Solution:

**He, F, and H** cannot serve as central atoms in a Lewis structure. Helium ( $1s^2$ ) is a noble gas, and as such, it does not need to bond to any other atoms. Hydrogen ( $1s^1$ ) and fluorine ( $1s^2 2s^2 2p^5$ ) only need one electron to complete their valence shells. Thus, they can only bond to one other atom, and they do not have  $d$  orbitals available to expand their valence shells.

10.2 Resonance must be present any time that a single Lewis structure is inadequate in explaining one or more aspects of a molecule or ion. The two N–O bonds in  $\text{NO}_2$  are equivalent in bond length and bond energy; no single Lewis structure can account for this. The following Lewis structures may be drawn for  $\text{NO}_2$ :

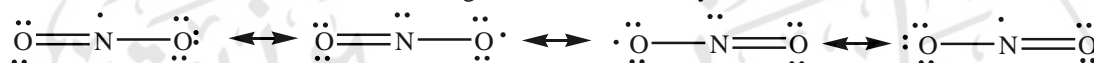

The average of all of these structures gives equivalent N–O bonds with a bond length that is between N–O and N=O.

10.3 Plan: For an element to obey the octet rule it must be surrounded by eight electrons. To determine the number of electrons present, (1) count the individual electrons actually shown adjacent to a particular atom (lone pairs), and (2) add two times the number of bonds to that atom: number of electrons = individual electrons + 2(number of bonds).

Solution:

(a)  $0 + 2(4) = 8$ ; (b)  $2 + 2(3) = 8$ ; (c)  $0 + 2(5) = 10$ ; (d)  $2 + 2(3) = 8$ ; (e)  $0 + 2(4) = 8$ ; (f)  $2 + 2(3) = 8$ ;  
(g)  $0 + 2(3) = 6$ ; (h)  $8 + 2(0) = 8$ . **All the structures obey the octet rule except: c and g.**

10.4 For an atom to expand its valence shell, it must have readily available  $d$  orbitals. The  $d$  orbitals do not become readily available until the third period or below on the periodic table. For the elements in the problem F, S, H, Al, Se, and Cl, the period numbers are 2, 3, 1, 3, 4, and 3, respectively. All of these elements, except those in the first two periods (H and F), can expand their valence shells.

10.5 Plan: Count the valence electrons and draw Lewis structures.

Solution:

Total valence electrons:  $\text{SiF}_4$ :  $[1 \times \text{Si}(4e^-)] + [4 \times \text{F}(7e^-)] = 32$ ;  $\text{SeCl}_2$ :  $[1 \times \text{Se}(6e^-)] + [2 \times \text{Cl}(7e^-)] = 20$ ;

$\text{COF}_2$ :  $[1 \times \text{C}(4e^-)] + [1 \times \text{O}(6e^-)] + [2 \times \text{F}(7e^-)] = 24$ . The Si, Se, and the C are the central atoms, because these are the elements in their respective compounds with the lower group number (in addition, we are told C is central). Place the other atoms around the central atoms and connect each to the central atom with a single bond.

$\text{SiF}_4$ : At this point, eight electrons ( $2e^-$  in four Si–F bonds) have been used with  $32 - 8 = 24$  remaining; the remaining electrons are placed around the fluorine atoms (three pairs each). All atoms have an octet.

$\text{SeCl}_2$ : The two bonds use  $4e^-$  ( $2e^-$  in two Se–Cl bonds) leaving  $20 - 4 = 16e^-$ . These  $16e^-$  are used to complete the octets on Se and the Cl atoms.

$\text{COF}_2$ : The three bonds to the C use  $6e^-$  ( $2e^-$  in three bonds) leaving  $24 - 6 = 18e^-$ . These  $18e^-$  are distributed to the surrounding atoms first to complete their octets. After the  $18e^-$  are used, the central C is two electrons short of an octet. Forming a double bond to the O (change a lone pair on O to a bonding pair on C) completes the C octet.

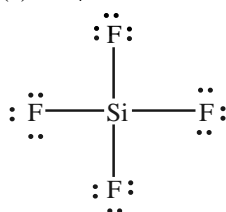
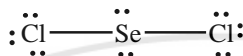
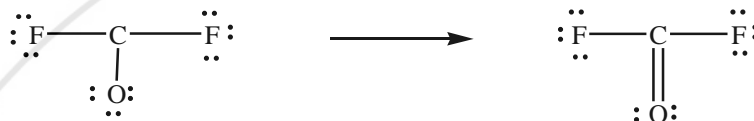
(a)  $\text{SiF}_4$ (b)  $\text{SeCl}_2$ (c)  $\text{COF}_2$ 

10.6 Total valence electrons:  $\text{PH}_4^+$  has 8;  $\text{C}_2\text{F}_4$  has 36; and  $\text{SbH}_3$  has 8. Ignoring H, the atom in the lower group number is central: P, C, and Sb. Added proof: H and F are never central. The two central C atoms must be adjacent. Place all the other atoms around the central atom. Split the F atoms so that each C gets two. Connect all the atoms with single bonds. This uses all the electrons in  $\text{PH}_4^+$ , and gives P an octet. The H atoms need no additional electrons. The C atoms have six electrons each, but can achieve an octet by forming a double bond. Splitting the twenty-four remaining electrons in  $\text{C}_2\text{F}_4$  into twelve pairs and giving three pairs to each F leaves each F with an octet. The last two electrons in  $\text{SbH}_3$  end as a lone pair on the Sb, and complete its octet.

(a)

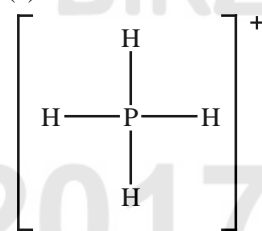

(b)

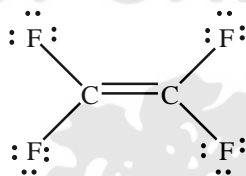

(c)

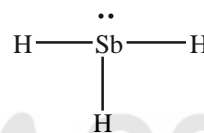

10.7 Plan: Count the valence electrons and draw Lewis structures.

Solution:

a)  $\text{PF}_3$ :  $[1 \times \text{P}(5e^-)] + [3 \times \text{F}(7e^-)] = 26$  valence electrons. P is the central atom. Draw single bonds from P to the three F atoms, using  $2e^- \times 3 \text{ bonds} = 6e^-$ . Remaining  $e^-$ :  $26 - 6 = 20e^-$ . Distribute the  $20e^-$  around the P and F atoms to complete their octets.

b)  $\text{H}_2\text{CO}_3$ :  $[2 \times \text{H}(1e^-)] + [1 \times \text{C}(4e^-)] + 3 \times \text{O}(6e^-) = 24$  valence electrons. C is the central atom with the H atoms attached to the O atoms. Place appropriate single bonds between all atoms using  $2e^- \times 5 \text{ bonds} = 10e^-$  so that  $24 - 10 = 14e^-$  remain. Use these  $14e^-$  to complete the octets of the O atoms (the H atoms already have their two electrons). After the  $14e^-$  are used, the central C is two electrons short of an octet. Forming a double bond to the O that does not have an H bonded to it (change a lone pair on O to a bonding pair on C) completes the C octet.

c)  $\text{CS}_2$ :  $[1 \times \text{C}(4e^-)] + [2 \times \text{S}(6e^-)] = 16$  valence electrons. C is the central atom. Draw single bonds from C to the two S atoms, using  $2e^- \times 2 \text{ bonds} = 4e^-$ . Remaining  $e^-$ :  $16 - 4 = 12e^-$ . Use these  $12e^-$  to complete the octets of the surrounding S atoms; this leaves C four electrons short of an octet. Form a double bond from each S to the C by changing a lone pair on each S to a bonding pair on C.

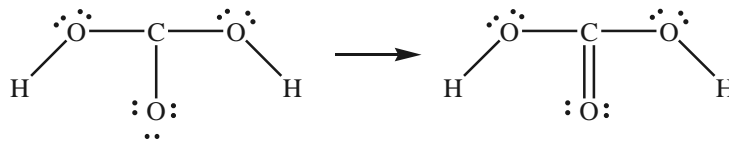
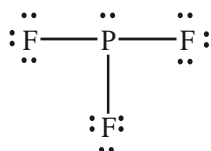
a)  $\text{PF}_3$  (26 valence  $e^-$ )b)  $\text{H}_2\text{CO}_3$  (24 valence  $e^-$ )

c) CS<sub>2</sub> (16 valence e<sup>-</sup>)

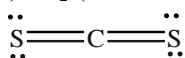

10.8 The C and S atoms are central. The S in part a) is attached to an H and the C. All atoms are attached with single bonds and the remaining electrons are divided into lone pairs. All the atoms, except H, have octets.

a) CH<sub>4</sub>S

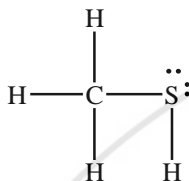

b) S<sub>2</sub>Cl<sub>2</sub>

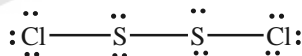

c) CHCl<sub>3</sub>

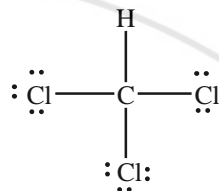

10.9 Plan: The problem asks for resonance structures, so there must be more than one answer for each part.

Solution:

a) NO<sub>2</sub><sup>+</sup> has [1 x N(5e<sup>-</sup>)] + [2 x O(6e<sup>-</sup>)] - 1e<sup>-</sup> (+ charge) = 16 valence electrons. Draw a single bond from N to each O, using 2e<sup>-</sup> x 2 bonds = 4e<sup>-</sup>; 16 - 4 = 12e<sup>-</sup> remain. Distribute these 12e<sup>-</sup> to the O atoms to complete their octets. This leaves N 4e<sup>-</sup> short of an octet. Form a double bond from each O to the N by changing a lone pair on each O to a bonding pair on N. No resonance is required as all atoms can achieve an octet with double bonds.

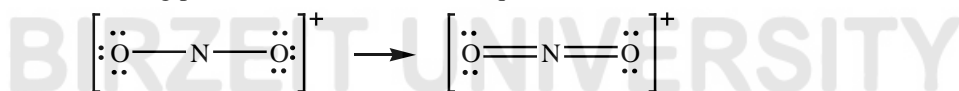

b) NO<sub>2</sub>F has [1 x N(5e<sup>-</sup>)] + [2 x O(6e<sup>-</sup>)] + [1 x F(7e<sup>-</sup>)] = 24 valence electrons. Draw a single bond from N to each surrounding atom, using 2e<sup>-</sup> x 3 bonds = 6e<sup>-</sup>; 24 - 6 = 18e<sup>-</sup> remain. Distribute these 18e<sup>-</sup> to the O and F atoms to complete their octets. This leaves N 2e<sup>-</sup> short of an octet. Form a double bond from either O to the N by changing a lone pair on O to a bonding pair on N. There are two resonance structures since a lone pair from either of the two O atoms can be moved to a bonding pair with N:

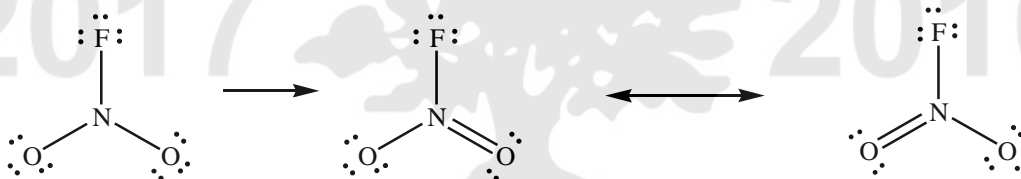

10.10 a)

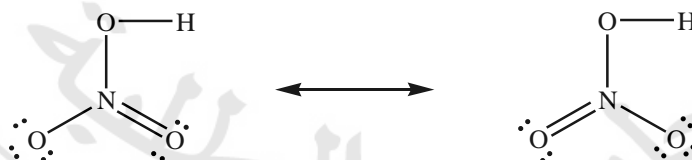

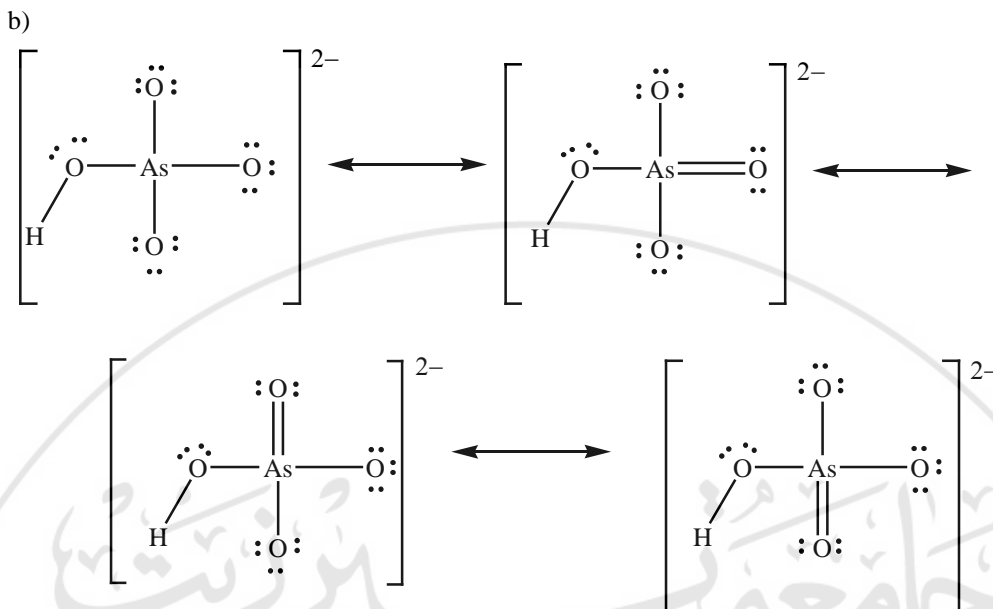

10.11 **Plan:** Count the valence electrons and draw Lewis structures. Additional structures are needed to show resonance.

**Solution:**

a)  $\text{N}_3^-$  has  $[3 \times \text{N}(5e^-)] + [1 e^- \text{ (from charge)}] = 16$  valence electrons. Place a single bond between the nitrogen atoms. This uses  $2e^- \times 2 \text{ bonds} = 4$  electrons, leaving  $16 - 4 = 12$  electrons (6 pairs). Giving three pairs on each end nitrogen gives them an octet, but leaves the central N with only four electrons as shown below:

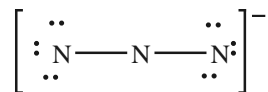

The central N needs four electrons. There are three options to do this: (1) each of the end N atoms could form a double bond to the central N by sharing one of its pairs; (2) one of the end N atoms could form a triple bond by sharing two of its lone pairs; (3) the other end N atom could form the triple bond instead.

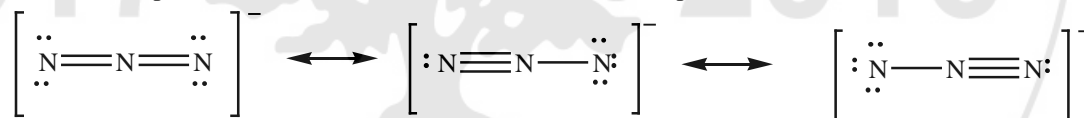

b)  $\text{NO}_2^-$  has  $[1 \times \text{N}(5e^-)] + [2 \times \text{O}(6e^-)] + [1 e^- \text{ (from charge)}] = 18$  valence electrons. The nitrogen should be the central atom with each of the oxygen atoms attached to it by a single bond ( $2e^- \times 2 \text{ bonds} = 4$  electrons). This leaves  $18 - 4 = 14$  electrons (seven pairs). If three pairs are given to each O and one pair is given to the N, then both O atoms have an octet, but the N atom only has six. To complete an octet the N atom needs to gain a pair of electrons from one O atom or the other (form a double bond). The resonance structures are:

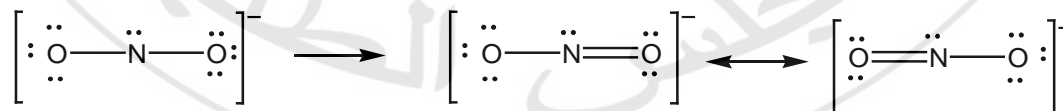

10.12 a)  $\text{HCO}_2^-$  has 18 valence electrons.

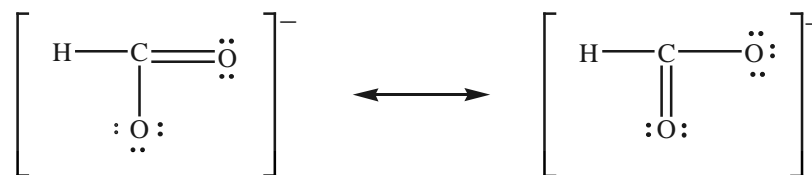

b)  $\text{HBrO}_4$  has 32 valence electrons.

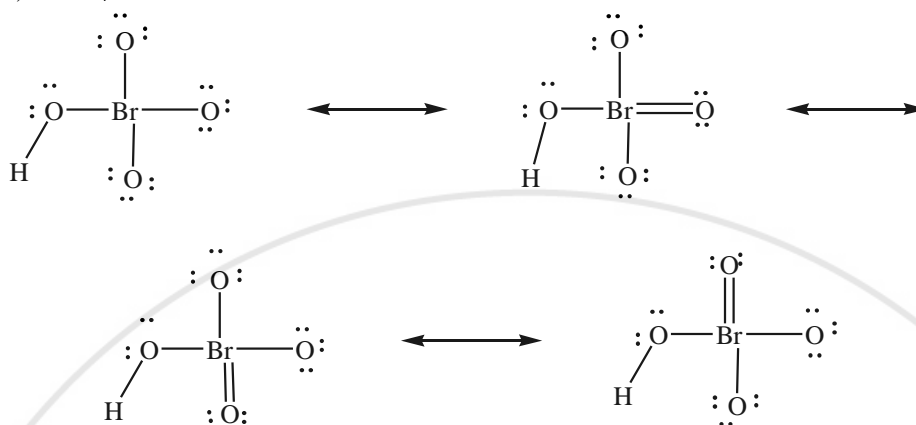

10.13 Plan: Initially, the method used in the preceding problems may be used to establish a Lewis structure. The total of the formal charges must equal the charge on an ion or be equal to 0 for a compound. The formal charge only needs to be calculated once for a set of identical atoms. Formal charge (FC) = no. of valence electrons – [no. of unshared valence electrons +  $\frac{1}{2}$  no. of shared valence electrons].

Solution:

a)  $\text{IF}_5$  has  $[1 \times \text{I}(7e^-)] + [5 \times \text{F}(7e^-)] = 42$  valence electrons. The presence of five F atoms around the central I means that the I atom will have a minimum of ten electrons; thus, this is an exception to the octet rule. The five I–F bonds use  $2e^- \times 5$  bonds = 10 electrons leaving  $42 - 10 = 32$  electrons (16 pairs). Each F needs three pairs to complete an octet. The five F atoms use fifteen of the sixteen pairs, so there is one pair left for the central I. This gives:

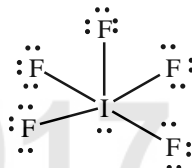

Calculating formal charges:

FC = no. of valence electrons – [no. of unshared valence electrons +  $\frac{1}{2}$  no. of shared valence electrons].

For iodine:  $\text{FC}_I = 7 - [2 + \frac{1}{2}(10)] = 0$  For each fluorine:  $\text{FC}_F = 7 - [6 + \frac{1}{2}(2)] = 0$

Total formal charge = 0 = charge on the compound.

b)  $\text{AlH}_4^-$  has  $[1 \times \text{Al}(3e^-)] + [4 \times \text{H}(1e^-)] + [1e^- \text{ (from charge)}] = 8$  valence electrons.

The four Al–H bonds use all the electrons and Al has an octet.

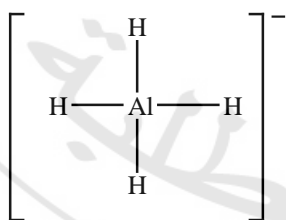

FC = no. of valence electrons – [no. of unshared valence electrons +  $\frac{1}{2}$  no. of shared valence electrons].

For aluminum:  $\text{FC}_{\text{Al}} = 3 - [0 + \frac{1}{2}(8)] = -1$

For each hydrogen:  $\text{FC}_H = 1 - [0 + \frac{1}{2}(2)] = 0$

10.14 a) OCS has sixteen valence electrons.

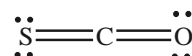

$\text{FC}_S = 6 - [4 + \frac{1}{2}(4)] = 0$

$\text{FC}_C = 4 - [0 + \frac{1}{2}(8)] = 0$

$\text{FC}_O = 6 - [4 + \frac{1}{2}(4)] = 0$





- 10.16 a)  $\text{AsO}_4^{3-}$  has 32 valence electrons. See structure I.  
 $\text{FC}_{\text{As}} = 5 - [0 + \frac{1}{2}(8)] = +1$        $\text{FC}_{\text{O}} = 6 - [6 + \frac{1}{2}(2)] = -1$   
 Net formal charge  $(+1 - 4) = -3$       The octet rule is followed by all atoms.

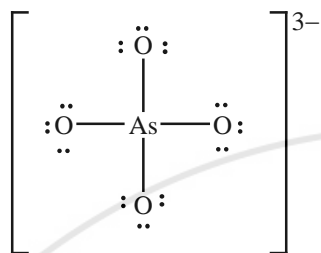

I

For more reasonable formal charges, move a lone pair from an O to a bonded pair on As (structure II):

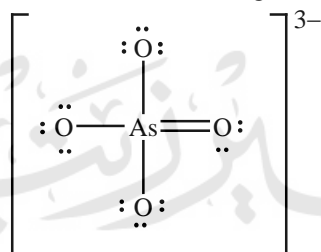

II

$$\text{FC}_{\text{As}} = 5 - [0 + \frac{1}{2}(10)] = 0 \quad \text{FC}_{\text{O}(\text{single bond})} = 6 - [6 + \frac{1}{2}(2)] = -1 \quad \text{FC}_{\text{O}(\text{double bond})} = 6 - [4 + \frac{1}{2}(4)] = 0$$

Net formal charge:  $(0 + 3(-1)) + 0 = -3$       Improved formal charge distribution

O.N.: O  $-2$  each  $\times 4 = -8$  total; As  $+5$

b)  $\text{ClO}_2^-$  has 20 valence electrons. For structure I in which all atoms have an octet:

$$\text{FC}_{\text{Cl}} = 7 - [4 + \frac{1}{2}(4)] = +1 \quad \text{FC}_{\text{O}} = 6 - [6 + \frac{1}{2}(2)] = -1$$

For more reasonable formal charges, see structure II:

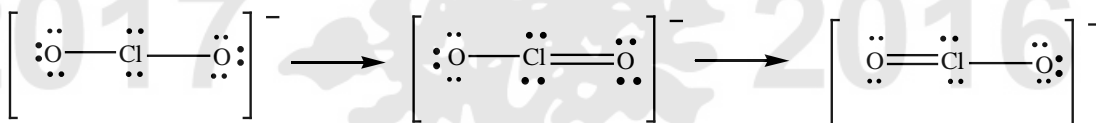

I

II

Formal charges in structure II:

$$\text{FC}_{\text{Cl}} = 7 - [4 + \frac{1}{2}(6)] = 0$$

$$\text{FC}_{\text{O}(\text{double bond})} = 6 - [4 + \frac{1}{2}(4)] = 0$$

$$\text{FC}_{\text{O}(\text{single bond})} = 6 - [6 + \frac{1}{2}(2)] = -1$$

O.N.: O  $-2$  each  $\times 2 = -4$  total; Cl  $+3$

- 10.17 Plan: The octet rule states that when atoms bond, they share electrons to attain a filled outer shell of eight electrons. If an atom has fewer than eight electrons, it is electron deficient; if an atom has more than eight electrons around it, the atom has an expanded octet.

Solution:

a)  $\text{BH}_3$  has  $[1 \times \text{B}(3e^-)] + [3 \times \text{H}(1e^-)] = 6$  valence electrons. These are used in three B–H bonds. The B has six electrons instead of an octet; this molecule is **electron deficient**.

b)  $\text{AsF}_4^-$  has  $[1 \times \text{As}(5e^-)] + [4 \times \text{F}(7e^-)] + [1e^- \text{ (from charge)}] = 34$  valence electrons. Four As–F bonds use eight electrons leaving  $34 - 8 = 26$  electrons (13 pairs). Each F needs three pairs to complete its octet and the remaining pair goes to the As. The As has an **expanded octet** with ten electrons. The F cannot expand its octet.

c)  $\text{SeCl}_4$  has  $[1 \times \text{Se}(6e^-)] + [4 \times \text{Cl}(7e^-)] = 34$  valence electrons. The  $\text{SeCl}_4$  is isoelectronic (has the same electron structure) as  $\text{AsF}_4^-$ , and so its Lewis structure looks the same. Se has an **expanded octet** of ten electrons.

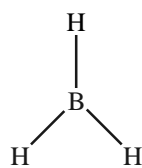

(a)

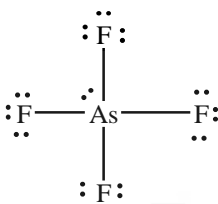

(b)

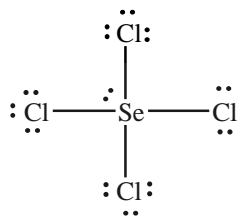

(c)

10.18 a)  $\text{PF}_6^-$  has 48 valence electrons. P has an **expanded octet** of 12  $e^-$ .

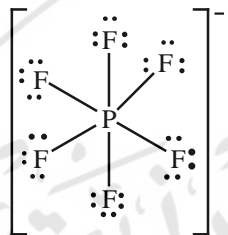

b)  $\text{ClO}_3$  has twenty-five valence electrons. The odd number means that there will be an exception. This is a radical: the chlorine or one of the oxygen atoms will lack an  $e^-$  to complete its octet.

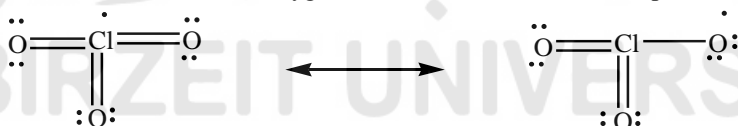

There are two additional resonance structures where the other O atoms are the ones lacking the octet. The FC predicts that Cl will end with the odd electron.

c)  $\text{H}_3\text{PO}_3$  has twenty-six valence electrons. To balance the formal charges; the O lacking an H will form a double bond to the P. This compound is an exception in that one of the H atoms is attached to the central P.

P has an **expanded octet** of 10  $e^-$ .

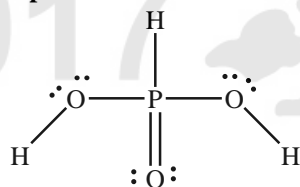

10.19 Plan: The octet rule states that when atoms bond, they share electrons to attain a filled outer shell of eight electrons. If an atom has fewer than eight electrons, it is electron deficient; if an atom has more than eight electrons around it, the atom has an expanded octet.

Solution:

a)  $\text{BrF}_3$  has  $[1 \times \text{Br}(7e^-)] + [3 \times \text{F}(7e^-)] = 28$  valence electrons. Placing a single bond between Br and each F uses  $2e^- \times 3 \text{ bonds} = 6e^-$ , leaving  $28 - 6 = 22$  electrons (eleven pairs). After the F atoms complete their octets with three pairs each, the Br gets the last two lone pairs. The Br has an **expanded octet** of ten electrons.

b)  $\text{ICl}_2^-$  has  $[1 \times \text{I}(7e^-)] + [2 \times \text{Cl}(7e^-)] + [1e^- \text{ (from charge)}] = 22$  valence electrons. Placing a single bond between I and each Cl uses  $2e^- \times 2 \text{ bond} = 4e^-$ , leaving  $22 - 4 = 18$  electrons (nine pairs). After the Cl atoms complete their octets with three pairs each, the iodine finishes with the last three lone pairs. The iodine has an **expanded octet** of ten electrons.

c)  $\text{BeF}_2$  has  $[1 \times \text{Be}(2e^-)] + [2 \times \text{F}(7e^-)] = 16$  valence electrons. Placing a single bond between Be and each of the F atoms uses  $2e^- \times 2 \text{ bonds} = 4e^-$ , leaving  $16 - 4 = 12$  electrons (six pairs). The F atoms complete their octets with three pairs each, and there are no electrons left for the Be. Formal charges work against the formation of double bonds. Be, with only four electrons, is **electron deficient**.

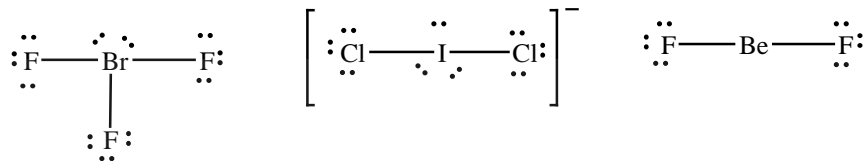

a)

b)

c)

- 10.20 a)  $\text{O}_3^-$  has nineteen valence electrons (note the odd number). There are several resonance structures possible; only one is necessary for the answer. One of the O atoms has the odd electron (seven total).

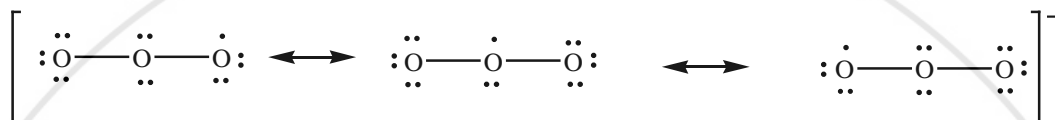

- b)
- $\text{XeF}_2$
- has twenty-two valence electrons.

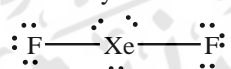
Xe has an **expanded octet** of  $10e^-$ .

- c)
- $\text{SbF}_4^-$
- has thirty-four valence electrons.

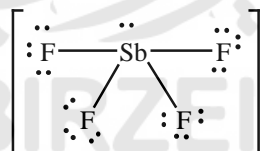
Sb has an **expanded octet** of  $10e^-$ .

- 10.21
- Plan:
- Draw Lewis structures for the reactants and products.

Solution:

Beryllium chloride has the formula  $\text{BeCl}_2$ .  $\text{BeCl}_2$  has  $[1 \times \text{Be}(2e^-)] + [2 \times \text{Cl}(7e^-)] = 16$  valence electrons. Four of these electrons are used to place a single bond between Be and each of the Cl atoms, leaving  $16 - 4 = 12$  electrons (six pairs). These six pairs are used to complete the octets of the Cl atoms, but Be does not have an octet – it is electron deficient.

Chloride ion has the formula  $\text{Cl}^-$  with an octet of electrons.

$\text{BeCl}_4^{2-}$  has  $[1 \times \text{Be}(2e^-)] + [4 \times \text{Cl}(7e^-)] + [2e^- \text{ (from charge)}] = 32$  valence electrons. Eight of these electrons are used to place a single bond between Be and each Cl atom, leaving  $32 - 8 = 24$  electrons (twelve pairs). These twelve pairs complete the octet of the Cl atoms (Be already has an octet).

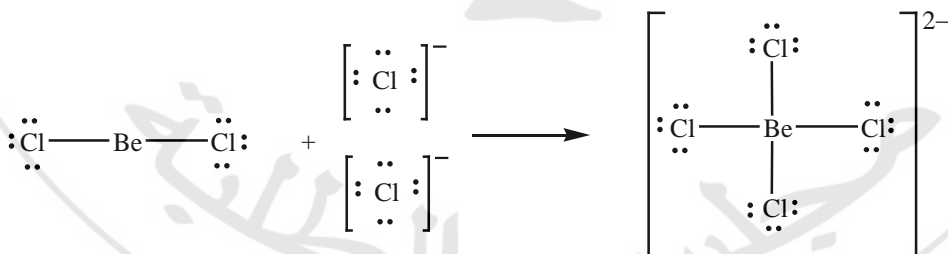

- 10.22 Draw a Lewis structure. If the formal charges are not ideal, a second structure may be needed.  $\text{BrO}_4^-$  has thirty-two valence electrons.

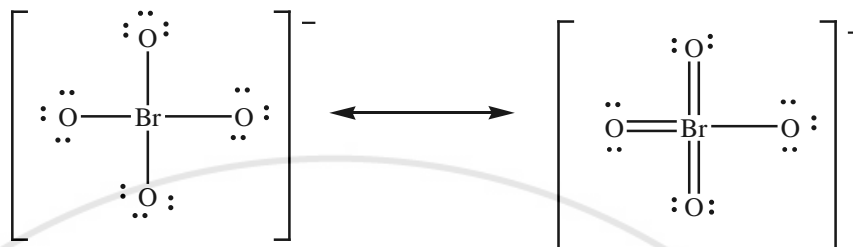

In the structure on the left, all atoms have octets. The formal charges are:

$$\text{FC}_{\text{Br}} = 7 - [0 + \frac{1}{2}(8)] = +3 \quad \text{FC}_{\text{O}} = 6 - [6 + \frac{1}{2}(2)] = -1$$

The structure on the right expands the valence shell of the Br to give more favorable formal charges.

$$\text{FC}_{\text{Br}} = 7 - [0 + \frac{1}{2}(14)] = 0 \quad \text{FC}_{\text{O}(\text{single bonded})} = 6 - [6 + \frac{1}{2}(2)] = -1 \quad \text{FC}_{\text{O}(\text{double bonded})} = 6 - [4 + \frac{1}{2}(4)] = 0$$

- 10.23 Count the total valence electrons and draw a Lewis structure.  $\text{AlF}_6^{3-}$  has forty-eight valence electrons.

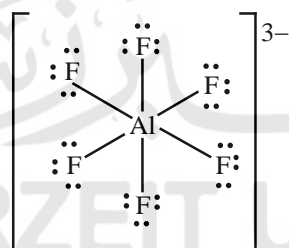

- 10.24 Plan: Use the structures in the text to determine the formal charges.

Formal charge (FC) = no. of valence electrons – [no. of unshared valence electrons +  $\frac{1}{2}$  no. of shared valence electrons].

Solution:

Structure A:  $\text{FC}_{\text{C}} = 4 - [0 + \frac{1}{2}(8)] = 0$ ;  $\text{FC}_{\text{O}} = 6 - [4 + \frac{1}{2}(4)] = 0$ ;  $\text{FC}_{\text{Cl}} = 7 - [6 + \frac{1}{2}(2)] = 0$

Total FC = 0

Structure B:  $\text{FC}_{\text{C}} = 4 - [0 + \frac{1}{2}(8)] = 0$ ;  $\text{FC}_{\text{O}} = 6 - [6 + \frac{1}{2}(2)] = -1$ ;

$\text{FC}_{\text{Cl}(\text{double bonded})} = 7 - [4 + \frac{1}{2}(4)] = +1$ ;  $\text{FC}_{\text{Cl}(\text{single bonded})} = 7 - [6 + \frac{1}{2}(2)] = 0$

Total FC = 0

Structure C:  $\text{FC}_{\text{C}} = 4 - [0 + \frac{1}{2}(8)] = 0$ ;  $\text{FC}_{\text{O}} = 6 - [6 + \frac{1}{2}(2)] = -1$ ;

$\text{FC}_{\text{Cl}(\text{double bonded})} = 7 - [4 + \frac{1}{2}(4)] = +1$ ;  $\text{FC}_{\text{Cl}(\text{single bonded})} = 7 - [6 + \frac{1}{2}(2)] = 0$

Total FC = 0

Structure A has the most reasonable set of formal charges.

- 10.25 Determine the total number of valence electrons present. Next, draw a Lewis structure. Finally, use VSEPR or valence bond theory to predict the shape.
- 10.26 The molecular shape and the electron-group arrangement are the same when there are no lone pairs on the central atom.
- 10.27 A bent (V-shaped) molecule will have the stoichiometry  $\text{AX}_2$ , so only  $\text{AX}_2\text{E}_n$  geometries result in a bent molecule. The presence of one or two lone pairs in the **three and four electron-group arrangements** can produce a bent (V-shaped) molecule as either  $\text{AX}_2\text{E}$  or  $\text{AX}_2\text{E}_2$ . Examples are:  $\text{NO}_2^-$  and  $\text{H}_2\text{O}$ .

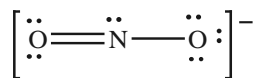

$$120^\circ$$

$$\text{AX}_2\text{E}$$

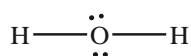

$$109.5^\circ$$

$$\text{AX}_2\text{E}_2$$

10.28 Plan: Examine a list of all possible structures, and choose the ones with four electron groups since the tetrahedral electron-group arrangement has four electron groups.

Solution:

Tetrahedral	$AX_4$
Trigonal pyramidal	$AX_3E$
Bent or V shaped	$AX_2E_2$

10.29 a) **A**, which has a square planar molecular geometry, has the most electron pairs. There are four shared pairs and two unshared pairs for a total of six pairs of electrons. The six electron pairs are arranged in an octahedral arrangement with the four bonds in a square planar geometry. **B** and **C** have five electron pairs and **D** has four electron pairs.

b) **A** has the most unshared pairs around the central atom with two unshared pairs. **B** has only one unshared pair on the central atom and **C** and **D** have no unshared pairs on the central atom.

c) **C and D** have only shared pairs around the central atom.

10.30 The number of electron pairs governs the overall arrangement of the electrons. The superposition of the atoms on this arrangement gives rise to the molecular shape. The actual molecular shape reflects the positions of the atoms, not the positions of electron pairs.

10.31 Plan: Begin with the basic structures and redraw them.

Solution:

a) A molecule that is V shaped has two bonds and generally has either one ( $AX_2E$ ) or two ( $AX_2E_2$ ) lone electron pairs.

b) A trigonal planar molecule follows the formula  $AX_3$  with three bonds and no lone electron pairs.

c) A trigonal bipyramidal molecule contains five bonding pairs (single bonds) and no lone pairs ( $AX_5$ ).

d) A T-shaped molecule has three bonding groups and two lone pairs ( $AX_3E_2$ ).

e) A trigonal pyramidal molecule follows the formula  $AX_3E$  with three bonding pairs and one lone pair.

f) A square pyramidal molecule shape follows the formula  $AX_5E$  with five bonding pairs and one lone pair.

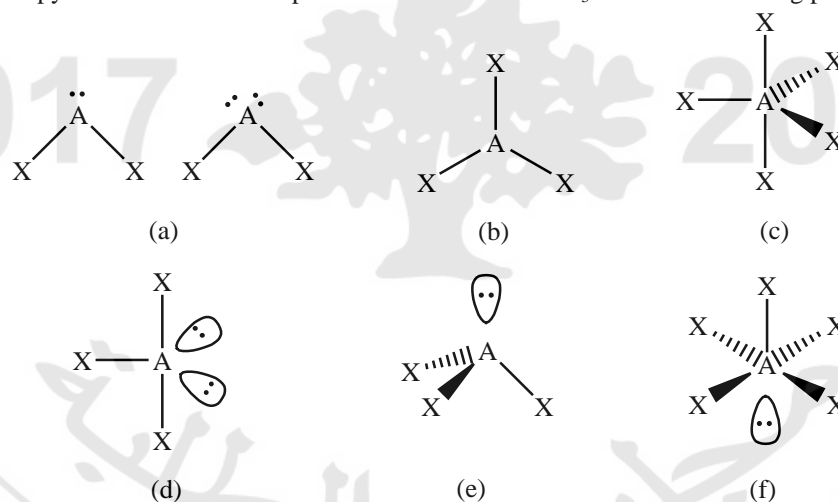

10.32 Determine the geometry from the lone pairs and the number of groups attached to the central atom.

a) $AX_3E$	tetrahedral	$109.5^\circ$	smaller
b) $AX_2$	linear	$180^\circ$	none
c) $AX_3$	trigonal planar	$120^\circ$	none
d) $AX_2E_2$	tetrahedral	$109.5^\circ$	smaller
e) $AX_2$	linear	$180^\circ$	none
f) $AX_4E$	trigonal bipyramidal	$180^\circ, 120^\circ, 90^\circ$	smaller

10.33 Plan: First, draw a Lewis structure, and then apply VSEPR.

Solution:

a)  $O_3$ : The molecule has  $[3 \times O(6e^-)] = 18$  valence electrons. Four electrons are used to place single bonds between the oxygen atoms, leaving  $18 - 4 = 14e^-$  (seven pairs). Six pairs are required to give the end oxygen atoms an octet; the last pair is distributed to the central oxygen, leaving this atom two electrons short of an octet. Form a double bond from one of the end O atoms to the central O by changing a lone pair on the end O to a bonding pair on the central O. This gives the following Lewis structure:

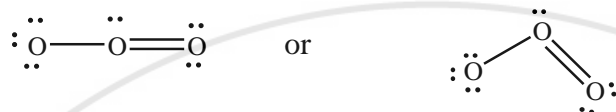

There are three electron groups around the central O, one of which is a lone pair. This gives a **trigonal planar** electron-group arrangement ( $AX_2E$ ), a **bent** molecular shape, and an ideal bond angle of  $120^\circ$ .

b)  $H_3O^+$ : This ion has  $[3 \times H(1e^-)] + [1 \times O(6e^-)] - [1e^- \text{ (due to + charge)}] =$  eight valence electrons. Six electrons are used to place a single bond between O and each H, leaving  $8 - 6 = 2e^-$  (one pair). Distribute this pair to the O atom, giving it an octet (the H atoms only get two electrons). This gives the following Lewis structure:



There are four electron groups around the O, one of which is a lone pair. This gives a **tetrahedral** electron-group arrangement ( $AX_3E$ ), a **trigonal pyramidal** molecular shape, and an ideal bond angle of  $109.5^\circ$ .

c)  $NF_3$ : The molecule has  $[1 \times N(5e^-)] + [3 \times F(7e^-)] = 26$  valence electrons. Six electrons are used to place a single bond between N and each F, leaving  $26 - 6 = 20e^-$  (ten pairs). These ten pairs are distributed to all of the F atoms and the N atoms to give each atom an octet. This gives the following Lewis structure:



There are four electron groups around the N, one of which is a lone pair. This gives a **tetrahedral** electron-group arrangement ( $AX_3E$ ), a **trigonal pyramidal** molecular shape, and an ideal bond angle of  $109.5^\circ$ .

10.34	Lewis structure	Electron-group arrangement	Molecular shape	Ideal bond angle
(a)	$\left[ \begin{array}{c} \cdot\cdot \\ \cdot\cdot \\ \text{:O} - \text{S} - \text{O} \\    \\ \text{O} \\ \cdot\cdot \\ \cdot\cdot \end{array} \right]^{2-}$	Tetrahedral	Tetrahedral	$109.5^\circ$
(b)	$\left[ \begin{array}{c} \cdot\cdot \\ \cdot\cdot \\ \text{:O} - \text{N} = \text{O} \\ \cdot\cdot \\ \cdot\cdot \end{array} \right]^-$	Trigonal planar	Bent	$120^\circ$

In addition, there are other resonance forms.

In addition, there are other resonance forms.

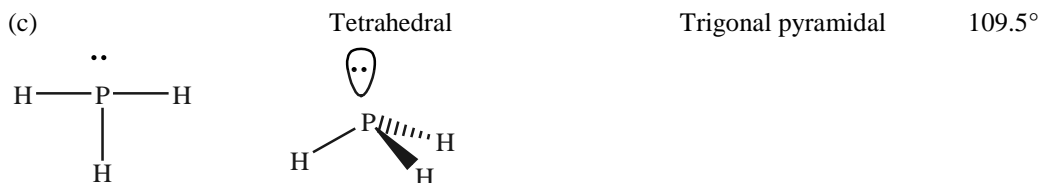

10.35 Plan: First, draw a Lewis structure, and then apply VSEPR.

Solution:

(a)  $\text{CO}_3^{2-}$ : This ion has  $[1 \times \text{C}(4e^-)] + [3 \times \text{O}(6e^-)] + [2e^- \text{ (from charge)}] = 24$  valence electrons. Six electrons are used to place single bonds between C and each O atom, leaving  $24 - 6 = 18 e^-$  (nine pairs). These nine pairs are used to complete the octets of the three O atoms, leaving C two electrons short of an octet. Form a double bond from one of the O atoms to C by changing a lone pair on an O to a bonding pair on C. This gives the following Lewis structure:

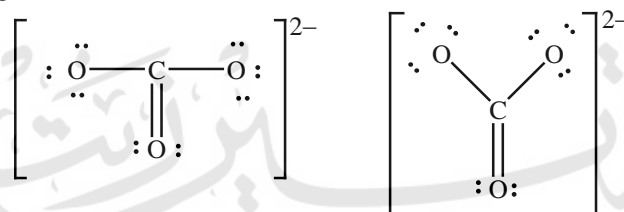

There are two additional resonance forms. There are three groups of electrons around the C, none of which are lone pairs. This gives a **trigonal planar** electron-group arrangement ( $\text{AX}_3$ ), a **trigonal planar** molecular shape, and an ideal bond angle of  $120^\circ$ .

(b)  $\text{SO}_2$ : This molecule has  $[1 \times \text{S}(6e^-)] + [2 \times \text{O}(6e^-)] = 18$  valence electrons. Four electrons are used to place a single bond between S and each O atom, leaving  $18 - 4 = 14e^-$  (seven pairs). Six pairs are needed to complete the octets of the O atoms, leaving a pair of electrons for S. S needs one more pair to complete its octet. Form a double bond from one of the end O atoms to the S by changing a lone pair on the O to a bonding pair on the S. This gives the following Lewis structure:



There are three groups of electrons around the C, one of which is a lone pair.

This gives a **trigonal planar** electron-group arrangement ( $\text{AX}_2\text{E}$ ), a **bent (V-shaped)** molecular shape, and an ideal bond angle of  $120^\circ$ .

(c)  $\text{CF}_4$ : This molecule has  $[1 \times \text{C}(4e^-)] + [4 \times \text{F}(7e^-)] = 32$  valence electrons. Eight electrons are used to place a single bond between C and each F, leaving  $32 - 8 = 24 e^-$  (twelve pairs). Use these twelve pairs to complete the octets of the F atoms (C already has an octet). This gives the following Lewis structure:

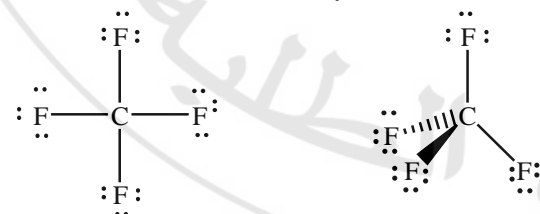

There are four groups of electrons around the C, none of which is a lone pair.

This gives a **tetrahedral** electron-group arrangement ( $\text{AX}_4$ ), a **tetrahedral** molecular shape, and an ideal bond angle of  $109.5^\circ$ .

10.36	Lewis structure	Electron-group arrangement	Molecular shape	Ideal bond angle
		Trigonal planar	Trigonal planar	120°
		Linear	Linear	180°
		Tetrahedral	Tetrahedral	109.5°

10.37 Plan: Examine the structure shown, and then apply VSEPR.

Solution:

a) This structure shows three electron groups with three bonds around the central atom. There appears to be no distortion of the bond angles so the shape is **trigonal planar**, the classification is **AX<sub>3</sub>**, with an ideal bond angle of **120°**.

b) This structure shows three electron groups with three bonds around the central atom. The bonds are distorted down indicating the presence of a lone pair. The shape of the molecule is **trigonal pyramidal** and the classification is **AX<sub>3</sub>E**, with an ideal bond angle of **109.5°**.

c) This structure shows five electron groups with five bonds around the central atom. There appears to be no distortion of the bond angles so the shape is **trigonal bipyramidal** and the classification is **AX<sub>5</sub>**, with ideal bond angles of **90°** and **120°**.

- 10.38 a) This structure shows five electron groups with five bonds around the central atom. There appears to be no distortion of the bond angles so the shape is **square pyramidal** (in reality square pyramidal structures have a slight distortion of the bond angles because there is a lone pair across from the atom at the apex of the pyramid). The classification is **AX<sub>5</sub>E**, with an ideal bond angle of **90°**.
- b) This structure shows three electron groups with three bonds around the central atom. There appears to be no distortion of the bond angles so the shape is **T shaped** (in reality T shaped structures have a slight distortion of the bond angles to the apical bonds because there are two equatorial lone pairs). The classification is **AX<sub>3</sub>E<sub>2</sub>**, with an ideal bond angle of **90°**.
- c) This structure shows four electron groups with four bonds around the central atom. There appears to be no distortion of the bond angles so the shape is **tetrahedral** and the classification is **AX<sub>4</sub>**, an ideal bond angle of **109.5°**.

10.39 Plan: The Lewis structures must be drawn, and VSEPR applied to the structures. Lone pairs on the central atom generally result in a deviation of the ideal bond angle.

Solution:

a) The  $\text{ClO}_2^-$  ion has  $[1 \times \text{Cl}(7e^-)] + [2 \times \text{O}(6e^-)] + [1e^- \text{ (from charge)}] = 20$  valence electrons. Four electrons are used to place a single bond between the Cl and each O, leaving  $20 - 4 = 16$  electrons (eight pairs). All eight pairs are used to complete the octets of the Cl and O atoms. There are two bonds (to the O atoms) and two lone pairs on the Cl for a total of four electron groups (**AX<sub>2</sub>E<sub>2</sub>**). The structure is based on a tetrahedral electron-group arrangement with an ideal bond angle of **109.5°**. The shape is **bent** (or V shaped). The presence of the lone pairs will cause the remaining angles to be **less than 109.5°**.

b) The  $\text{PF}_5$  molecule has  $[1 \times \text{P}(5e^-)] + [5 \times \text{F}(7e^-)] = 40$  valence electrons. Ten electrons are used to place single bonds between P and each F atom, leaving  $40 - 10 = 30e^-$  (fifteen pairs). The fifteen pairs are used to complete the octets of the F atoms. There are five bonds to the P and no lone pairs (**AX<sub>5</sub>**). The electron-group



arrangement and the shape is **trigonal bipyramidal**. The ideal bond angles are **90° and 120°**. The absence of lone pairs means the **angles are ideal**.

c) The  $\text{SeF}_4$  molecule has  $[1 \times \text{Se}(6e^-)] + [4 \times \text{F}(7e^-)] = 34$  valence electrons. Eight electrons are used to place single bonds between Se and each F atom, leaving  $34 - 8 = 26e^-$  (thirteen pairs). Twelve pairs are used to complete the octets of the F atoms which leaves one pair of electrons. This pair is placed on the central Se atom. There are four bonds to the Se which also has a lone pair ( $\text{AX}_4\text{E}$ ). The structure is based on a trigonal bipyramidal structure with ideal angles of **90° and 120°**. The shape is **seesaw**. The presence of the lone pairs means the angles are **less than ideal**.

d) The  $\text{KrF}_2$  molecule has  $[1 \times \text{Kr}(8e^-)] + [2 \times \text{F}(7e^-)] = 22$  valence electrons. Four electrons are used to place a single bond between the Kr atom and each F atom, leaving  $22 - 4 = 18e^-$  (nine pairs). Six pairs are used to complete the octets of the F atoms. The remaining three pairs of electrons are placed on the Kr atom. The Kr is the central atom. There are two bonds to the Kr and three lone pairs ( $\text{AX}_2\text{E}_3$ ). The structure is based on a trigonal bipyramidal structure with ideal angles of  $90^\circ$  and  $120^\circ$ . The shape is **linear**. The placement of the F atoms makes their ideal bond angle to be  $2 \times 90^\circ = 180^\circ$ . The placement of the lone pairs is such that they cancel each other's repulsion, thus the actual **bond angle is ideal**.

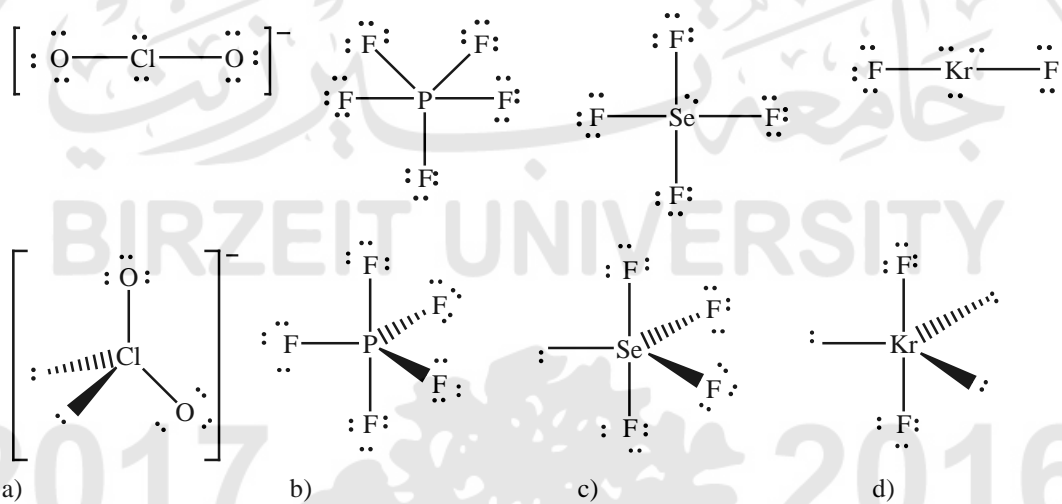

- 10.40 a) The  $\text{ClO}_3^-$  ion has twenty-six valence electrons. The Cl is the central atom. There are three bonds (to the O atoms) and one lone pair on the Cl ( $\text{AX}_3\text{E}$ ). The shape is **trigonal pyramidal**. The structure is based on a tetrahedral electron-group arrangement with an ideal bond angle of **109.5°**. The presence of the lone pair will cause the remaining angles to be **less than 109.5°**.
- b) The  $\text{IF}_4^-$  ion has thirty-six valence electrons. The I is the central atom. There are four bonds to the I and two lone pairs ( $\text{AX}_4\text{E}_2$ ). The shape is **square planar**. The structure is based on an octahedral electron-group arrangement with ideal bond angles of **90°**. The repulsion from the two lone pairs cancels so the **angles are ideal**.
- c) The  $\text{SeOF}_2$  molecule has twenty-six valence electrons. The Se is the central atom. There are three bonds to the Se which also has a lone pair ( $\text{AX}_3\text{E}$ ). The shape is **trigonal pyramidal**. The structure is based on a tetrahedral structure with ideal angles of **109.5°**. The presence of the lone pair means the angles are **less than ideal**.
- d) The  $\text{TeF}_5^-$  ion has forty-two valence electrons. The Te is the central atom. There are five bonds to the Te which also has one lone pair ( $\text{AX}_5\text{E}$ ). The shape is **square pyramidal**. The structure is based on an octahedral with ideal angles of **90°**. The presence of the lone pair means the angles are **less than ideal**.

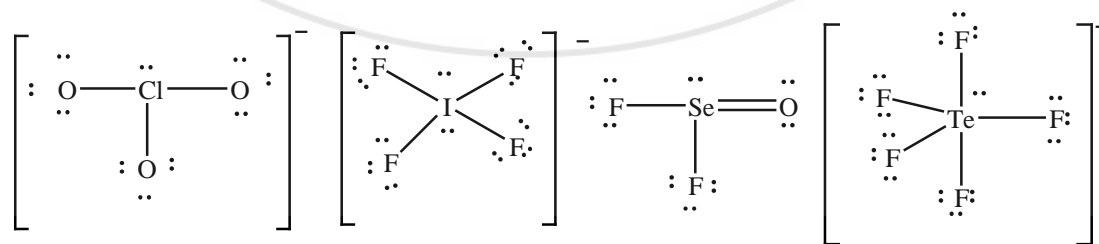

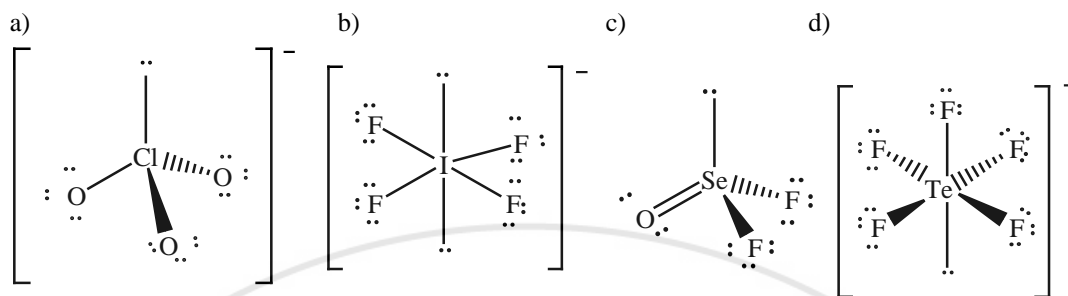

10.41 Plan: The Lewis structures must be drawn, and VSEPR applied to the structures.

Solution:

a)  $\text{CH}_3\text{OH}$ : This molecule has  $[1 \times \text{C}(4e^-)] + [4 \times \text{H}(1e^-)] + [1 \times \text{O}(6e^-)] =$  fourteen valence electrons. In the  $\text{CH}_3\text{OH}$  molecule, both carbon and oxygen serve as central atoms. (H can never be central.) Use eight electrons to place a single bond between the C and the O atom and three of the H atoms and another two electrons to place a single bond between the O and the last H atom. This leaves  $14 - 10 = 4 e^-$  (two pairs). Use these two pairs to complete the octet of the O atom. C already has an octet and each H only gets two electrons. The carbon has four bonds and no lone pairs ( $\text{AX}_4$ ), so it is **tetrahedral** with **no deviation** (no lone pairs) from the ideal angle of  $109.5^\circ$ . The oxygen has two bonds and two lone pairs ( $\text{AX}_2\text{E}_2$ ), so it is **V shaped** or **bent** with the angles **less than the ideal** angle of  $109.5^\circ$ .

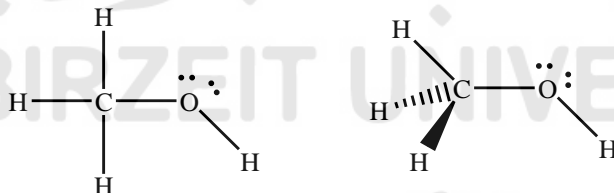

b)  $\text{N}_2\text{O}_4$ : This molecule has  $[2 \times \text{N}(5e^-)] + [4 \times \text{O}(6e^-)] = 34$  valence electrons. Use ten electrons to place a single bond between the two N atoms and between each N and two of the O atoms. This leaves  $34 - 10 = 24e^-$  (twelve pairs). Use the twelve pairs to complete the octets of the oxygen atoms. Neither N atom has an octet, however. Form a double bond from one O atom to one N atom by changing a lone pair on the O to a bonding pair on the N. Do this for the other N atom as well. In the  $\text{N}_2\text{O}_4$  molecule, both nitrogen atoms serve as central atoms. This is the arrangement given in the problem. Both nitrogen atoms are equivalent with three groups and no lone pairs ( $\text{AX}_3$ ), so the arrangement is **trigonal planar** with **no deviation** (no lone pairs) from the ideal angle of  $120^\circ$ . The same results arise from the other resonance structures.

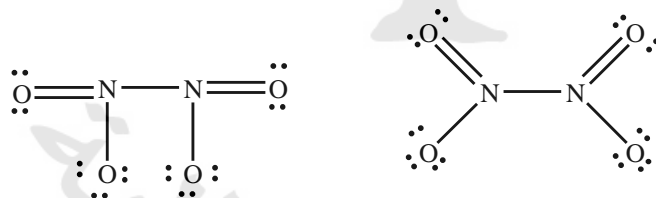

10.42 a) In the  $\text{H}_3\text{PO}_4$  molecule the P and each of the O atoms with an H attached serve as central atoms. The P has four groups and no lone pairs ( $\text{AX}_4$ ), so it is **tetrahedral** with **no deviation** from the ideal angle of  $109.5^\circ$ . The H bearing O atoms have two bonds and two lone pairs ( $\text{AX}_2\text{E}_2$ ), so the arrangement is **V shaped** or **bent** with angles **less than the ideal** value of  $109.5^\circ$ .

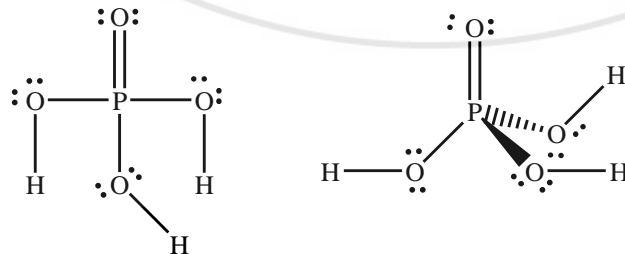

b) In the  $\text{CH}_3\text{OCH}_2\text{CH}_3$  molecule, all atoms except the hydrogen atoms serve as central atoms. All the carbons have four bonds and no lone pairs ( $\text{AX}_4$ ), so they are tetrahedral with no deviation from the ideal bond angle of  $109.5^\circ$ . The oxygen has two bonds and two lone pairs ( $\text{AX}_2\text{E}_2$ ), so the arrangement is **V shaped** or **bent** with angles **less than the ideal** value of  $109.5^\circ$ .

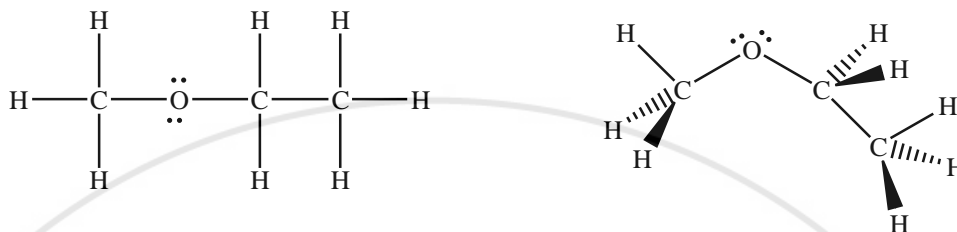

10.43 Plan: The Lewis structures must be drawn, and VSEPR applied to the structures.

Solution:

a)  $\text{CH}_3\text{COOH}$  has  $[2 \times \text{C}(4e^-)] + [4 \times \text{H}(1e^-)] + [2 \times \text{O}(6e^-)] =$  twenty-four valence electrons. Use fourteen electrons to place a single bond between all of the atoms. This leaves  $24 - 14 = 10 e^-$  (five pairs). Use these five pairs to complete the octets of the O atoms; the C atom bonded to the H atoms has an octet but the other C atom does not have a complete octet. Form a double bond from the O atom (not bonded to H) to the C by changing a lone pair on the O to a bonding pair on the C. In the  $\text{CH}_3\text{COOH}$  molecule, the carbons and the O with H attached serve as central atoms. The carbon bonded to the H atoms has four groups and no lone pairs ( $\text{AX}_4$ ), so it is **tetrahedral** with **no deviation** from the ideal angle of  $109.5^\circ$ . The carbon bonded to the O atoms has three groups and no lone pairs ( $\text{AX}_3$ ), so it is **trigonal planar** with **no deviation** from the ideal angle of  $120^\circ$ . The H bearing O has two bonds and two lone pairs ( $\text{AX}_2\text{E}_2$ ), so the arrangement is **V shaped** or **bent** with an angle **less than the ideal** value of  $109.5^\circ$ .

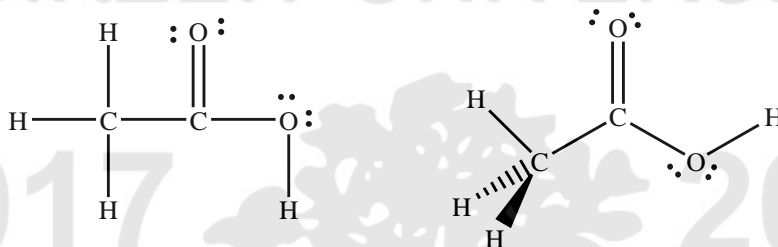

b)  $\text{H}_2\text{O}_2$  has  $[2 \times \text{H}(1e^-)] + [2 \times \text{O}(6e^-)] =$  fourteen valence electrons. Use six electrons to place single bonds between the O atoms and between each O atom and an H atom. This leaves  $14 - 6 = 8 e^-$  (four pairs). Use these four pairs to complete the octets of the O atoms. In the  $\text{H}_2\text{O}_2$  molecule, both oxygen atoms serve as central atoms. Both O atoms have two bonds and two lone pairs ( $\text{AX}_2\text{E}_2$ ), so they are **V shaped** or **bent** with angles **less than the ideal** value of  $109.5^\circ$ .

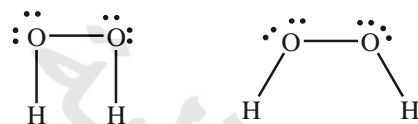

10.44 a) In the  $\text{H}_2\text{SO}_3$  molecule, the S and the O atoms with an H attached serve as central atoms. The S has three groups and one lone pair ( $\text{AX}_3\text{E}$ ), so it is **trigonal pyramidal** with angles **less than** the ideal angle of  $109.5^\circ$ . The H bearing O atoms each have two bonds and two lone pairs ( $\text{AX}_2\text{E}_2$ ), so the arrangement is **V shaped** or **bent** with an angle **less than the ideal** value of  $109.5^\circ$ .

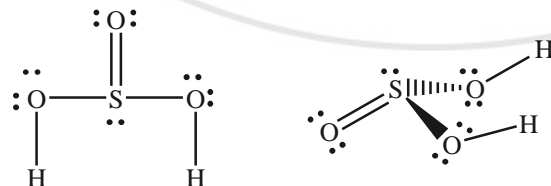

b) The  $\text{N}_2\text{O}_3$  molecule has the structure indicated in the problem with the N atoms serving as central atoms. The nitrogen labeled  $\text{N}_1$  has two groups and a lone pair ( $\text{AX}_2\text{E}$ ), so it is **V shaped** or **bent** with angles **less than the**

**ideal** value of  $120^\circ$ . The nitrogen labeled  $N_2$  has three bonds and no lone pairs ( $AX_3$ ), so it is **trigonal planar** with **no deviation** from the ideal angle of  $120^\circ$ .

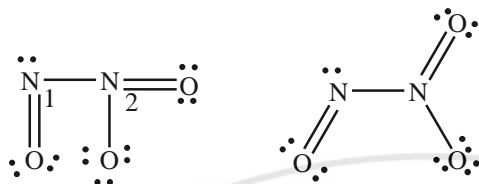

10.45 Plan: First, draw a Lewis structure, and then apply VSEPR. The presence of lone pairs on the central atom generally results in a smaller than ideal bond angle.

Solution:

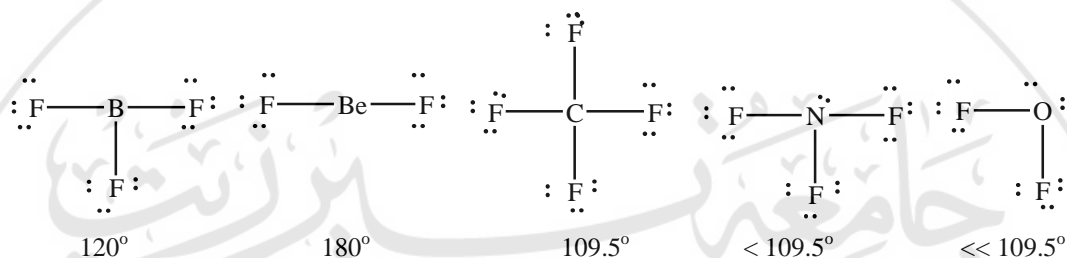

Bond angles:  $OF_2 < NF_3 < CF_4 < BF_3 < BeF_2$

$BeF_2$  is an  $AX_2$  type molecule, so the angle is the ideal  $180^\circ$ .  $BF_3$  is an  $AX_3$  molecule, so the angle is the ideal  $120^\circ$ .  $CF_4$ ,  $NF_3$ , and  $OF_2$  all have tetrahedral electron-group arrangements of the following types:  $AX_4$ ,  $AX_3E$ , and  $AX_2E_2$ , respectively. The ideal tetrahedral bond angle is  $109.5^\circ$ , which is present in  $CF_4$ . The one lone pair in  $NF_3$  decreases the angle a little. The two lone pairs in  $OF_2$  decrease the angle even more.

10.46

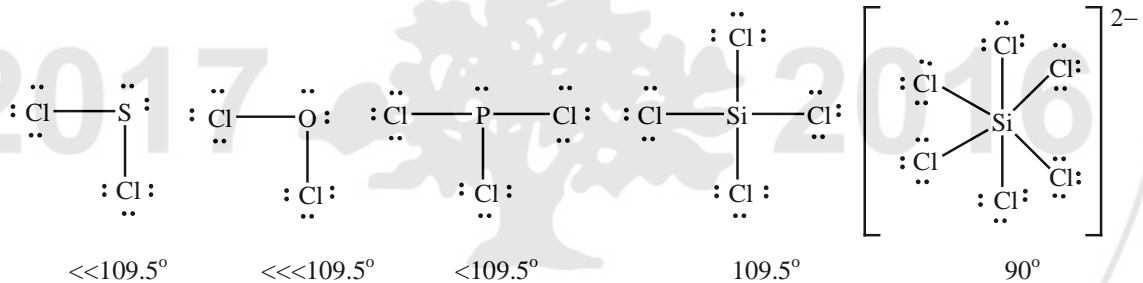

Bond angles:  $SiCl_4 > PCl_3 > SiCl_4 > OCl_2 > SiCl_6^{2-}$

All the species except  $SiCl_6^{2-}$  are based on a tetrahedral electron-group arrangement.  $SiCl_6^{2-}$  has an octahedral electron arrangement with an ideal angle of  $90^\circ$ . The tetrahedral arrangement has an ideal bond angle of  $109.5^\circ$ , which is present in  $AX_4$  species like  $SiCl_4$ . The ideal tetrahedral bond angle is reduced slightly by the lone pair in  $AX_3E$  species such as  $PCl_3$ . A greater reduction in the ideal tetrahedral bond angle is present in  $AX_2E_2$  species such as  $SCl_2$  and  $OCl_2$  with two lone pairs. The angle is reduced less around the larger S atom.

10.47 Plan: The ideal bond angles depend on the electron-group arrangement. Deviations depend on lone pairs.

Solution:

a) The C and N have three groups, so they are **ideally  $120^\circ$** , and the O has four groups, so **ideally the angle is  $109.5^\circ$** . The N and O have lone pairs, so the **angles are less than ideal**.

b) All central atoms have four pairs, so ideally all the angles are  **$109.5^\circ$** . The lone pairs on the O **reduce** this value.

c) The B has three groups (no lone pairs) leading to an **ideal bond angle of  $120^\circ$** . All the O atoms have four pairs (**ideally  $109.5^\circ$** ), two of which are lone, and **reduce the angle**.

10.48 a) The N has three groups, no lone pairs, so the angle is **ideal**, and equal to  **$120^\circ$** . The O, attached to the H, has four groups (**ideally  $109.5^\circ$** ); the lone pairs **reduce the bond angle from ideal**.

- b) The C, attached to the O, has three groups and no lone pairs so the angle will be the **ideal 120°**. The remaining C has four groups, and with no lone pairs the angle will be ideal and equal to **109.5°**.
- c) The C with three groups will have angles that are **ideal (120°)**. The O, with the H attached, has four groups. The presence of four groups gives an **ideal angle of 109.5°**, which is **reduced** by the lone pairs.

10.49

a) Type: AX<sub>2</sub>E  
Ideal angle: 120°

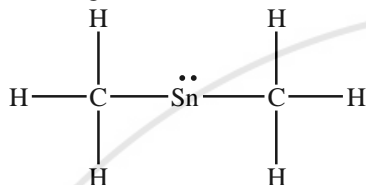

Shape: bent  
Actual angle: <120° (because of the lone pair)

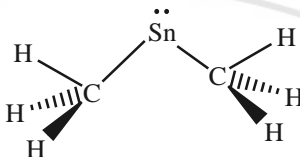

b) Type: AX<sub>3</sub>E  
Ideal angle: 109.5°

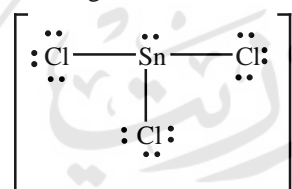

Shape: trigonal pyramidal  
Actual angle: <109.5° (because of the lone pair)

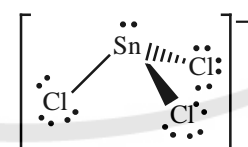

c) Type: AX<sub>4</sub>  
Ideal angle: 109.5°

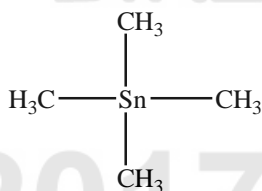

Shape: tetrahedral  
Actual angle: 109.5° (there are no lone pairs)

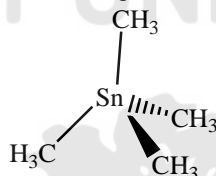

d) Type: AX<sub>5</sub>  
Ideal angles: 120° and 90°

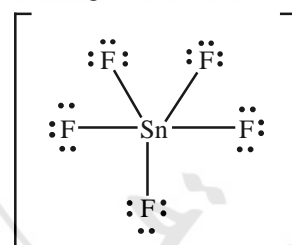

Shape: trigonal bipyramidal  
Actual angle: 120° and 90° (there are no lone pairs)

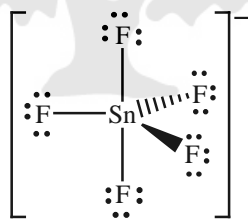

e) Type: AX<sub>6</sub>  
Ideal angles: 90°

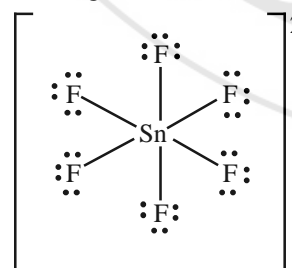

Shape: octahedral  
Actual angle: 90° (there are no lone pairs)

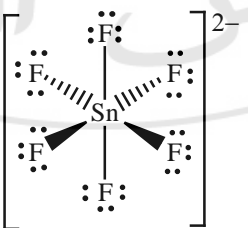

10.50 Plan: The Lewis structures are needed to predict the ideal bond angles.

Solution:

The P atoms have no lone pairs in any case so the angles are ideal.

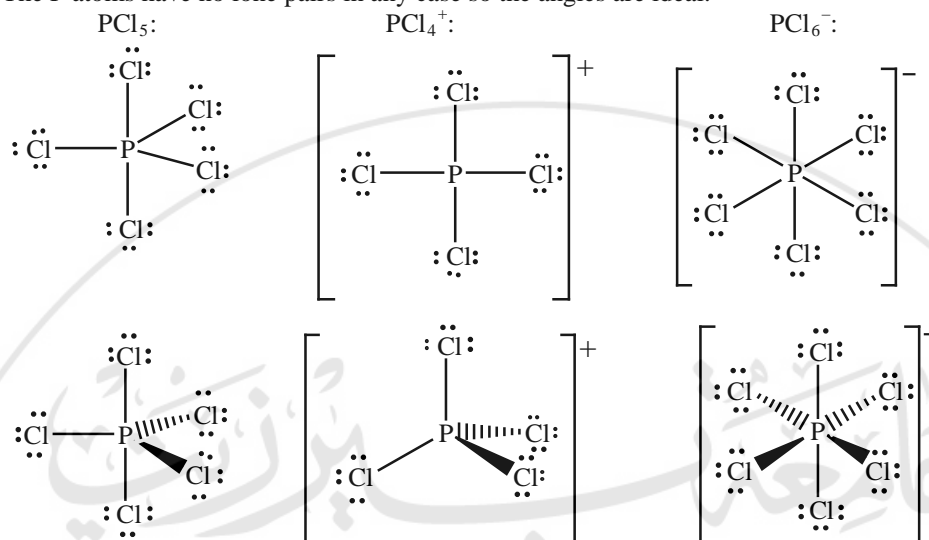

The original  $\text{PCl}_5$  is  $\text{AX}_5$ , so the shape is trigonal bipyramidal, and the angles are  $120^\circ$  and  $90^\circ$ .

The  $\text{PCl}_4^+$  is  $\text{AX}_4$ , so the shape is tetrahedral, and the angles are  $109.5^\circ$ .

The  $\text{PCl}_6^-$  is  $\text{AX}_6$ , so the shape is octahedral, and the angles are  $90^\circ$ .

Half the  $\text{PCl}_5$  (trigonal bipyramidal,  $120^\circ$  and  $90^\circ$ ) become tetrahedral  $\text{PCl}_4^+$  (tetrahedral,  $109.5^\circ$ ), and the other half become octahedral  $\text{PCl}_6^-$  (octahedral,  $90^\circ$ ).

10.51 Molecules are polar if they have polar bonds that are not arranged to cancel each other. If the polar covalent bonds are arranged in such a way as to cancel each other, the molecule will be nonpolar. An example of a molecule with polar covalent bonds that is not polar is  $\text{SO}_3$ . The trigonal planar shape causes the three polar S–O bonds to cancel.

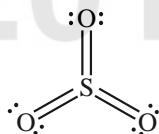

10.52 Plan: To determine if a bond is polar, determine the electronegativity difference of the atoms participating in the bond. The greater the electronegativity difference, the more polar the bond. To determine if a molecule is polar (has a dipole moment), it must have polar bonds, and a certain shape determined by VSEPR.

Solution:

a) Molecule	Bond	Electronegativities	Electronegativity difference
$\text{SCl}_2$	S–Cl	S = 2.5 Cl = 3.0	$3.0 - 2.5 = 0.5$
$\text{F}_2$	F–F	F = 4.0 F = 4.0	$4.0 - 4.0 = 0.0$
$\text{CS}_2$	C–S	C = 2.5 S = 2.5	$2.5 - 2.5 = 0.0$
$\text{CF}_4$	C–F	C = 2.5 F = 4.0	$4.0 - 2.5 = 1.5$
$\text{BrCl}$	Br–Cl	Br = 2.8 Cl = 3.0	$3.0 - 2.8 = 0.2$

The polarities of the bonds increase in the order:  $\text{F–F} = \text{C–S} < \text{Br–Cl} < \text{S–Cl} < \text{C–F}$ . Thus,  $\text{CF}_4$  has the most polar bonds.

b) The  $\text{F}_2$  and  $\text{CS}_2$  cannot be polar since they do not have polar bonds.  $\text{CF}_4$  is an  $\text{AX}_4$  molecule, so it is tetrahedral with the four polar C–F bonds arranged to cancel each other giving an overall nonpolar molecule. **BrCl has a dipole moment** since there are no other bonds to cancel the polar Br–Cl bond.  **$\text{SCl}_2$  has a dipole moment** (is polar) because it is a bent molecule,  $\text{AX}_2\text{E}_2$ , and the electron density in both S–Cl bonds is pulled towards the more electronegative chlorine atoms.

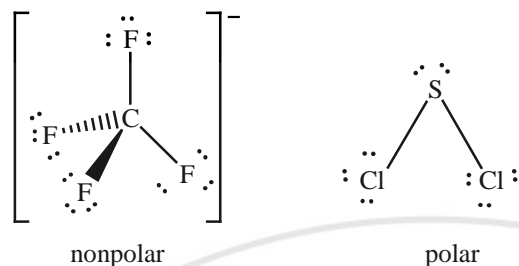

10.53 a) The greater the difference in electronegativity the more polar the bond:

Molecule	Bond	Electronegativities	Electronegativity difference
BF <sub>3</sub>	B–F	B = 2.0 F = 4.0	4.0 – 2.0 = 2.0
PF <sub>3</sub>	P–F	P = 2.1 F = 4.0	4.0 – 2.1 = 1.9
BrF <sub>3</sub>	Br–F	Br = 2.8 F = 4.0	4.0 – 2.8 = 1.2
SF <sub>4</sub>	S–F	S = 2.5 F = 4.0	4.0 – 2.5 = 1.5
SF <sub>6</sub>	S–F	S = 2.5 Cl = 4.0	4.0 – 2.5 = 1.5

The polarities of the bonds are increasing in the order: Br–F < S–F < P–F < B–F. Thus, **BF<sub>3</sub>** has the most polar bonds.

b) All the molecules meet the requirement of having polar bonds. The arrangement of the bonds must be considered in each case. **BF<sub>3</sub>** is trigonal planar, AX<sub>3</sub>, so it is nonpolar because the polarities of the bonds cancel. **PF<sub>3</sub> has a dipole moment** (is polar) because it has a trigonal pyramidal geometry, AX<sub>3</sub>E. **BrF<sub>3</sub> has a dipole moment** because it has a T-shaped geometry, AX<sub>3</sub>E<sub>2</sub>. **SF<sub>4</sub> has a dipole moment** because it has a see-saw geometry, AX<sub>4</sub>E. SF<sub>6</sub> is nonpolar because it is octahedral, AX<sub>6</sub>, and the bonds are arranged so they cancel.

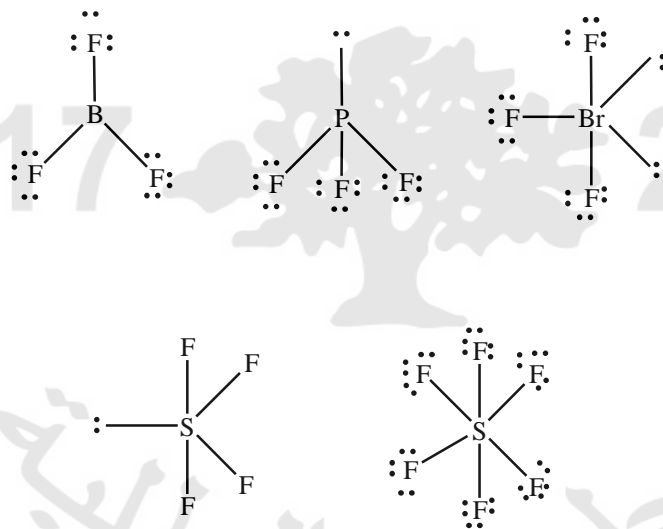

10.54 Plan: If only two atoms are involved, only an electronegativity difference is needed. The greater the difference in electronegativity, the more polar the bond. If there are more than two atoms, the molecular geometry must be determined.

Solution:

a) All the bonds are polar covalent. The SO<sub>3</sub> molecule is trigonal planar, AX<sub>3</sub>, so the bond dipoles cancel leading to a nonpolar molecule (no dipole moment). The SO<sub>2</sub> molecule is bent, AX<sub>2</sub>E, so the polar bonds result in electron density being pulled towards one side of the molecule. **SO<sub>2</sub> has a greater dipole moment** because it is the only one of the pair that is polar.

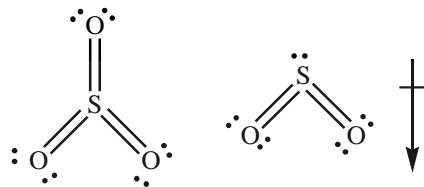

b) ICl and IF are polar, as are all diatomic molecules composed of atoms with differing electronegativities. The electronegativity difference for ICl ( $3.0 - 2.5 = 0.5$ ) is less than that for IF ( $4.0 - 2.5 = 1.5$ ). The greater difference means that **IF has a greater dipole moment**.

c) All the bonds are polar covalent. The  $\text{SiF}_4$  molecule is nonpolar (has no dipole moment) because the bonds are arranged tetrahedrally,  $\text{AX}_4$ .  $\text{SF}_4$  is  $\text{AX}_4\text{E}$ , so it has a see-saw shape, where the bond dipoles do not cancel.  **$\text{SF}_4$  has the greater dipole moment**.

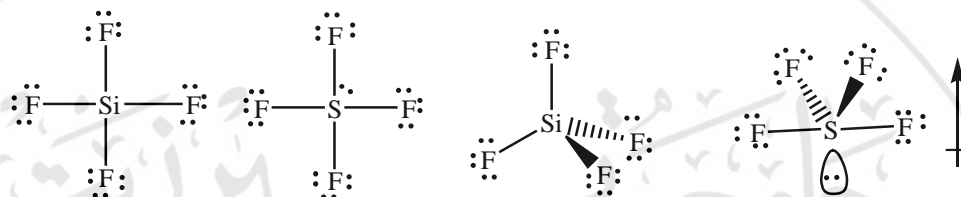

d)  $\text{H}_2\text{O}$  and  $\text{H}_2\text{S}$  have the same basic structure. They are both bent molecules,  $\text{AX}_2\text{E}_2$ , and as such, they are polar. The electronegativity difference in  $\text{H}_2\text{O}$  ( $3.5 - 2.1 = 1.4$ ) is greater than the electronegativity difference in  $\text{H}_2\text{S}$  ( $2.5 - 2.1 = 0.4$ ) so  **$\text{H}_2\text{O}$  has a greater dipole moment**.

- 10.55 a) All the bonds are polar covalent. Both the molecules are bent ( $\text{SO}_2$  and  $\text{ClO}_2$  are  $\text{AX}_2\text{E}_2$ ). The difference in electronegativity is greater in  $\text{SO}_2$  than in  $\text{ClO}_2$  so  **$\text{SO}_2$  has a greater dipole moment**.
- b) HBr and HCl are polar, as are all diatomic molecules composed of atoms with differing electronegativities. The electronegativity difference for HBr is less than that for HCl. The greater difference means that **HCl has a greater dipole moment**.
- c) All the bonds are polar covalent. The  $\text{BeCl}_2$  molecule is nonpolar (has no dipole moment) because the bonds are arranged linearly,  $\text{AX}_2$ .  $\text{SCl}_2$  is  $\text{AX}_2\text{E}_2$ , so it has a bent shape, where the bond dipoles do not cancel.  **$\text{SCl}_2$  has the greater dipole moment**.
- d) All the bonds are polar covalent.  $\text{AsF}_5$  is  $\text{AX}_5$ , so it is trigonal bipyramidal and nonpolar.  $\text{AsF}_3$  is  $\text{AX}_3\text{E}_2$ , so it is trigonal pyramidal and polar.  **$\text{AsF}_3$  has a greater dipole moment**.

- 10.56 Plan: Draw Lewis structures, and then apply VSEPR. A molecule has a dipole moment if polar bonds do not cancel.

Solution:

$\text{C}_2\text{H}_2\text{Cl}_2$  has  $[2 \times \text{C}(4e^-)] + [2 \times \text{H}(1e^-)] + [2 \times \text{Cl}(7e^-)] = 24$  valence electrons. The two carbon atoms are bonded to each other. The H atoms and Cl atoms are bonded to the C atoms. Use ten electrons to place a single bond between all of the atoms. This leaves  $24 - 10 = 14e^-$  (seven pairs). Use these seven pairs to complete the octets of the Cl atoms and one of the C atoms; the other C atom does not have a complete octet. Form a double bond between the carbon atoms by changing the lone pair on one C atom to a bonding pair. There are three possible structures for the compound  $\text{C}_2\text{H}_2\text{Cl}_2$ :

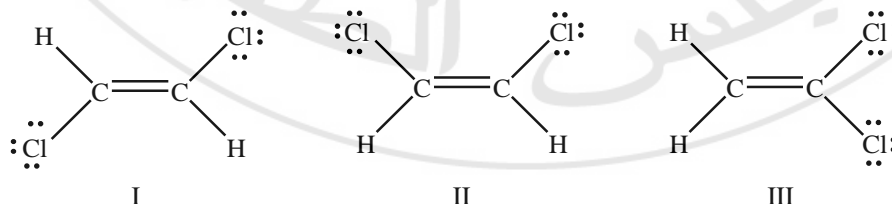

The presence of the double bond prevents rotation about the  $\text{C}=\text{C}$  bond, so the structures are “fixed.” The  $\text{C}-\text{Cl}$  bonds are more polar than the  $\text{C}-\text{H}$  bonds, so the key to predicting the polarity is the positioning of the  $\text{C}-\text{Cl}$  bonds. Structure I has the  $\text{C}-\text{Cl}$  bonds arranged so that they cancel leaving I as a nonpolar molecule. Both II and III have  $\text{C}-\text{Cl}$  bonds on the same side so the bonds work together making both molecules polar. Both I and II will react with  $\text{H}_2$  to give a compound with a Cl attached to each C (same product). Structure III will react with  $\text{H}_2$  to



give a compound with two Cl atoms on one C and none on the other (different product). **Structure I must be X** as it is the only one that is nonpolar (has no dipole moment). **Structure II must be Z** because it is polar and gives the same product as compound X. This means that **Structure III must be the remaining compound, Y**. **Compound Y (III) has a dipole moment.**

- 10.57 Plan: The Lewis structures are needed to do this problem. A single bond (bond order = 1) is weaker and longer than a double bond (bond order = 2) which is weaker and longer than a triple bond (bond order = 3). To find the heat of reaction, add the energy required to break all the bonds in the reactants to the energy released to form all bonds in the product. Remember to use a negative sign for the energy of the bonds formed since bond formation is exothermic. The bond energy values are found in Table 9.2.

Solution:

a) The H atoms cannot be central, and they are evenly distributed on the N atoms.

$\text{N}_2\text{H}_4$  has  $[2 \times \text{N}(5e^-)] + [4 \times \text{H}(1e^-)] =$  fourteen valence electrons, ten of which are used in the bonds between the atoms. The remaining two pairs are used to complete the octets of the N atoms.

$\text{N}_2\text{H}_2$  has  $[2 \times \text{N}(5e^-)] + (2 \times \text{H}(1e^-)) =$  twelve valence electrons, six of which are used in the bonds between the atoms. The remaining three pairs of electrons are not enough to complete the octets of both N atoms, so one lone pair is moved to a bonding pair between the N atoms.

$\text{N}_2$  has  $[2 \times \text{N}(5e^-)] =$  ten valence electrons, two of which are used to place a single bond between the two N atoms. Since only four pairs of electrons remain and six pairs are required to complete the octets, two lone pairs become bonding pairs to form a triple bond.

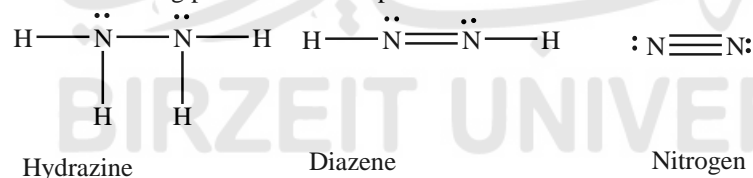

The **single (bond order = 1) N–N bond is weaker and longer** than any of the others are. The **triple bond (bond order = 3) is stronger and shorter** than any of the others. The **double bond (bond order = 2) has an intermediate strength and length.**

b)  $\text{N}_4\text{H}_4$  has  $[4 \times \text{N}(5e^-)] + [4 \times \text{H}(1e^-)] =$  twenty-four valence electrons, fourteen of which are used for single bonds between the atoms. When the remaining five pairs are distributed to complete the octets, one N atom lacks two electrons. A lone pair is moved to a bonding pair for a double bond.

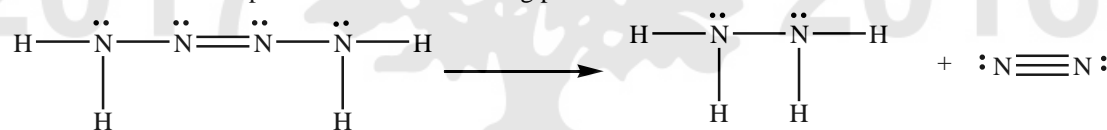

Reactant bonds broken:

$$4 \text{ N-H} = 4 \text{ mol } (391 \text{ kJ/mol}) = 1564 \text{ kJ}$$

$$2 \text{ N-N} = 2 \text{ mol } (160 \text{ kJ/mol}) = 320 \text{ kJ}$$

$$1 \text{ N=N} = 1 \text{ mol } (418 \text{ kJ/mol}) = 418 \text{ kJ}$$

$$\Sigma \Delta H_{\text{bonds broken}}^{\circ} = 2302 \text{ kJ}$$

Product bonds formed:

$$4 \text{ N-H} = 4 \text{ mol } (-391 \text{ kJ/mol}) = -1564 \text{ kJ}$$

$$1 \text{ N-N} = 1 \text{ mol } (-160 \text{ kJ/mol}) = -160 \text{ kJ}$$

$$1 \text{ N}\equiv\text{N} = 1 \text{ mol } (-945 \text{ kJ/mol}) = -945 \text{ kJ}$$

$$\Sigma \Delta H_{\text{bonds formed}}^{\circ} = -2669 \text{ kJ}$$

$$\Delta H_{\text{rxn}}^{\circ} = \Sigma \Delta H_{\text{bonds broken}}^{\circ} + \Sigma \Delta H_{\text{bonds formed}}^{\circ} = 2302 \text{ kJ} + (-2669 \text{ kJ}) = -367 \text{ kJ}$$

- 10.58 a)  $\text{SiF}_4$  with its thirty-two valence electrons is an  $\text{AX}_4$  molecule and has a tetrahedral molecular shape.  $\text{SiF}_5^-$  with its forty valence electrons is an  $\text{AX}_5$  ion and has a trigonal bipyramidal molecular shape. **B** best represents the change in molecular shape from tetrahedral to trigonal bipyramidal.
- b)  $\text{SiF}_4$ : tetrahedral,  $\text{AX}_4$ ;  $\text{SiF}_5^-$ : trigonal bipyramidal,  $\text{AX}_5$ .

- 10.59 Draw Lewis structures, and then determine the formal charges.  
The atom sequence may be ONF, NOF, or NFO. F is never central so the structure cannot be NFO.

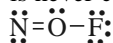

$$\text{FC}_{\text{O}} = +6 - (4 + 1/2(4)) = 0$$

$$\text{FC}_{\text{O}} = +6 - (2 + 1/2(6)) = +1$$

$$\text{FC}_{\text{N}} = +5 - (2 + 1/2(6)) = 0$$

$$\text{FC}_{\text{N}} = +5 - (4 + 1/2(4)) = -1$$

$$\text{FC}_{\text{F}} = +7 - (6 + 1/2(2)) = 0$$

$$\text{FC}_{\text{F}} = +7 - (6 + 1/2(2)) = 0$$

Thus, the structure on the left is the correct structure.

- 10.60 **Plan:** Use the Lewis structures shown in the text. The equation for formal charge (FC) is  
FC = no. of valence electrons – [no. of unshared valence electrons + 1/2 no. of shared valence electrons].

**Solution:**

a) Formal charges for  $\text{Al}_2\text{Cl}_6$ :

$$\text{FC}_{\text{Al}} = 3 - [0 + 1/2(8)] = -1$$

$$\text{FC}_{\text{Cl, ends}} = 7 - [6 + 1/2(2)] = 0$$

$$\text{FC}_{\text{Cl, bridging}} = 7 - [4 + 1/2(4)] = +1$$

(Check: Formal charges add to zero, the charge on the compound.)

Formal charges for  $\text{I}_2\text{Cl}_6$ :

$$\text{FC}_{\text{I}} = 7 - [4 + 1/2(8)] = -1$$

$$\text{FC}_{\text{Cl, ends}} = 7 - [6 + 1/2(2)] = 0$$

$$\text{FC}_{\text{Cl, bridging}} = 7 - [4 + 1/2(4)] = +1$$

(Check: Formal charges add to zero, the charge on the compound.)

b) The aluminum atoms have no lone pairs and are  $\text{AX}_4$ , so they are tetrahedral. The two tetrahedral Al atoms cannot give a planar structure. The iodine atoms in  $\text{I}_2\text{Cl}_6$  have two lone pairs each and are  $\text{AX}_4\text{E}_2$  so they are square planar. Placing the square planar I atoms adjacent can give a planar molecule.

- 10.61 The Lewis structure for each is required.

Compound

Lewis structure

Molecular geometry

$\text{XeF}_2$

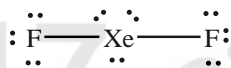

**Linear** ( $\text{AX}_2\text{E}_3$ )

$\text{XeF}_4$

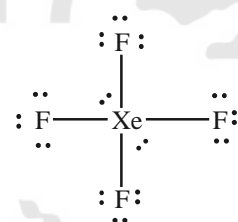

**Square planar** ( $\text{AX}_4\text{E}_2$ )

$\text{XeF}_6$

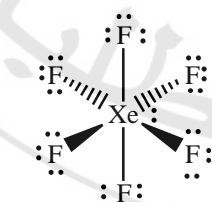

**Distorted octahedral** ( $\text{AX}_6\text{E}$ )

- 10.62 a)  $\text{SO}_3$  is an  $\text{AX}_3$  molecule and has a trigonal planar shape.  $\text{SO}_3^{2-}$  is an  $\text{AX}_3\text{E}$  species and has a trigonal pyramidal molecular shape. C best illustrates the change in molecular shape from trigonal planar to trigonal pyramidal.

b) **Yes**, there is a change in polarity during the reaction as the nonpolar  $\text{SO}_3$  molecule becomes the polar  $\text{SO}_3^{2-}$  ion.

- 10.63 From the Lewis structures, both are AX<sub>2</sub>E which has an ideal bond angle of 120°. But the “lone pair” on N in NO<sub>2</sub> is only half a pair, so it only exerts “half” the repulsion. This allows the bond angle to open to a larger than normal bond angle. The “complete” lone pair in NO<sub>2</sub><sup>-</sup>, like other lone pairs, forces the bonding pairs together to give a smaller than normal bond angle.

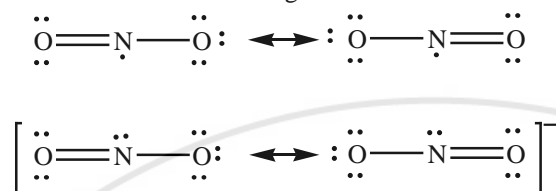

- 10.64  $\text{Xe}(g) + 3\text{F}_2(g) \rightarrow \text{XeF}_6(g)$

$$\Delta H_{\text{rxn}}^{\circ} = \Sigma \Delta H_{\text{bonds broken}}^{\circ} + \Sigma \Delta H_{\text{bonds formed}}^{\circ}$$

The three F-F bonds must be broken, and six Xe-F bonds are formed.

$$\Delta H_{\text{rxn}}^{\circ} = 3 \text{BE}_{\text{F-F}} + 6 \text{BE}_{\text{Xe-F}}$$

$$-402 \text{ kJ/mol} = (3 \text{ mol})(159 \text{ kJ/mol}) + (6 \text{ mol})(-\text{BE}_{\text{Xe-F}})$$

$$-879 \text{ kJ/mol} = 6 (-\text{BE}_{\text{Xe-F}})$$

$$146.5 = \mathbf{146 \text{ kJ/mol}} = \text{BE}_{\text{Xe-F}}$$

- 10.65

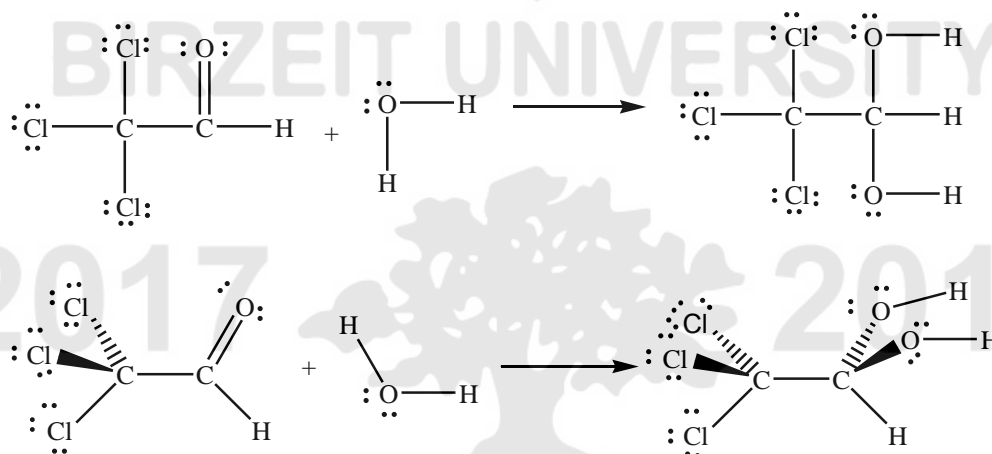

The C with the chlorine atoms attached does not change shape. That C is tetrahedral in both compounds. The other C changes from trigonal planar (AX<sub>3</sub>) to tetrahedral (AX<sub>4</sub>).

- 10.66

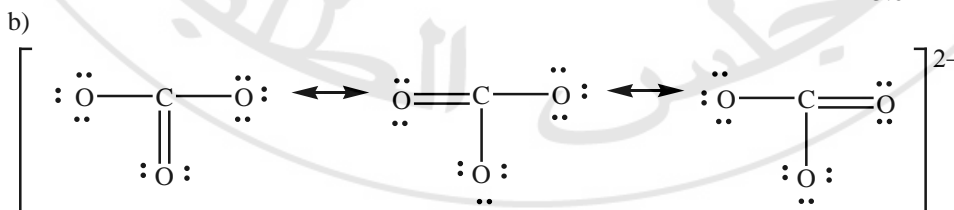

Each C-O bond is a single bond two-thirds of the time and a double bond the rest of the time.

The average is  $[(1 + 1 + 2)/3] = 4/3 = 1.33$

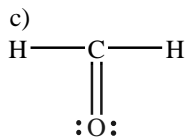

2.0

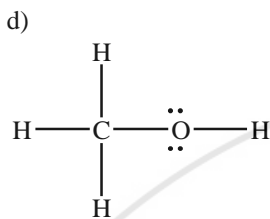

1.0

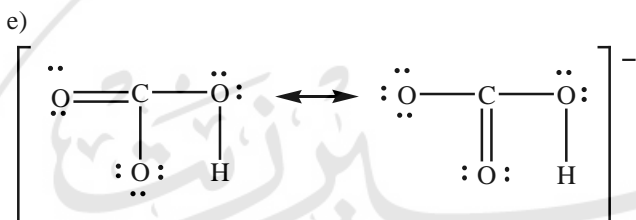

The resonating double bond means the average bond length is  $[(1 + 2)/2] = 1.5$

The C–O bond for the O attached to the H does not resonate and remains 1.0

Bond length  $\mathbf{a < c < e < b < d}$  ignoring O attached to H in part e)

Bond strength  $\mathbf{d < b < e < c < a}$

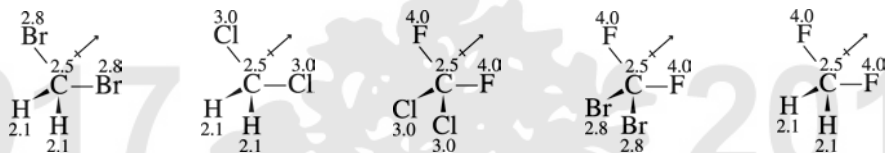

- 10.68 **Plan:** Ethanol burns (combusts) with  $\text{O}_2$  to produce  $\text{CO}_2$  and  $\text{H}_2\text{O}$ . To find the heat of reaction in part a), add the energy required to break all the bonds in the reactants to the energy released to form all bonds in the product. Remember to use a negative sign for the energy of the bonds formed since bond formation is exothermic. The bond energy values are found in Table 9.2. The heat of vaporization of ethanol must be included for part b). The enthalpy change in part c) is the sum of the heats of formation of the products minus the sum of the heats of formation of the reactants. The calculation for part d) is the same as in part a).

**Solution:**

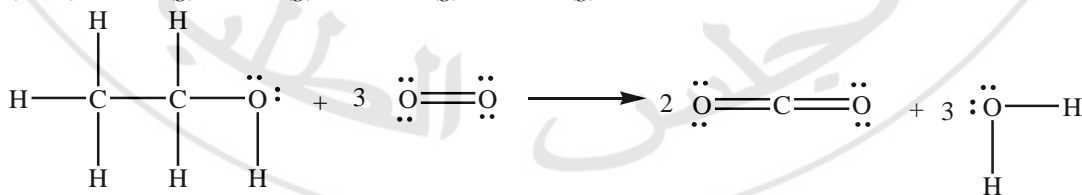
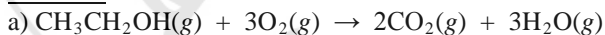

Reactant bonds broken:

$$1 \times \text{C}-\text{C} = (1 \text{ mol})(347 \text{ kJ/mol}) = 347 \text{ kJ}$$

$$5 \times \text{C}-\text{H} = (5 \text{ mol})(413 \text{ kJ/mol}) = 2065 \text{ kJ}$$

$$1 \times \text{C}-\text{O} = (1 \text{ mol})(358 \text{ kJ/mol}) = 358 \text{ kJ}$$

$$1 \times \text{O}-\text{H} = (1 \text{ mol})(467 \text{ kJ/mol}) = 467 \text{ kJ}$$

$$3 \times \text{O}=\text{O} = (3 \text{ mol})(498 \text{ kJ/mol}) = 1494 \text{ kJ}$$

$$\Sigma \Delta H_{\text{bonds broken}}^{\circ} = 4731 \text{ kJ}$$

Product bonds formed:

$$4 \times \text{C=O} = (4 \text{ mol})(-799 \text{ kJ/mol}) = -3196 \text{ kJ}$$

$$6 \times \text{O-H} = (6 \text{ mol})(-467 \text{ kJ/mol}) = -2802 \text{ kJ}$$

$$\Sigma \Delta H_{\text{bonds formed}}^{\circ} = -5998 \text{ kJ}$$

$$\Delta H_{\text{rxn}}^{\circ} = \Sigma \Delta H_{\text{bonds broken}}^{\circ} + \Sigma \Delta H_{\text{bonds formed}}^{\circ} = 4731 \text{ kJ} + (-5998 \text{ kJ}) = -1267 \text{ kJ} \text{ for each mole of ethanol burned}$$

b) If it takes 40.5 kJ/mol to vaporize the ethanol, part of the heat of combustion must be used to convert liquid ethanol to gaseous ethanol. The new value becomes:

$$\Sigma \Delta H_{\text{combustion (liquid)}}^{\circ} = -1267 \text{ kJ} + (1 \text{ mol}) \left[ \frac{40.5 \text{ kJ}}{1 \text{ mol}} \right] = -1226.5 = -1226 \text{ kJ per mole of liquid ethanol burned}$$

$$\text{c) } \Delta H_{\text{rxn}}^{\circ} = \Sigma m \Delta H_{\text{f}}^{\circ}(\text{products}) - \Sigma n \Delta H_{\text{f}}^{\circ}(\text{reactants})$$

$$\Delta H_{\text{rxn}}^{\circ} = \{2 \Delta H_{\text{f}}^{\circ} [\text{CO}_2(\text{g})] + 3 \Delta H_{\text{f}}^{\circ} [\text{H}_2\text{O}(\text{g})]\} - \{1 \Delta H_{\text{f}}^{\circ} [\text{C}_2\text{H}_5\text{OH}(\text{l})] + 3 \Delta H_{\text{f}}^{\circ} [\text{O}_2(\text{g})]\}$$

$$= [(2 \text{ mol})(-393.5 \text{ kJ/mol}) + (3 \text{ mol})(-241.826 \text{ kJ/mol})] - [(1 \text{ mol})(-277.63 \text{ kJ/mol}) + 3 \text{ mol}(0 \text{ kJ/mol})]$$

$$= -1234.848 = -1234.8 \text{ kJ}$$

The two answers differ by less than 10 kJ. This is a very good agreement since average bond energies were used to calculate the answers in a) and b).

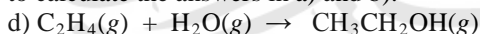

The Lewis structures for the reaction are:

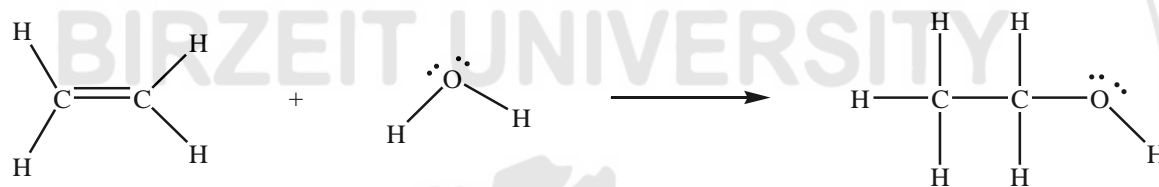

Reactant bonds broken:

$$1 \times \text{C=C} = (1 \text{ mol})(614 \text{ kJ/mol}) = 614 \text{ kJ}$$

$$4 \times \text{C-H} = (4 \text{ mol})(413 \text{ kJ/mol}) = 1652 \text{ kJ}$$

$$2 \times \text{O-H} = (2 \text{ mol})(467 \text{ kJ/mol}) = 934 \text{ kJ}$$

$$\Sigma \Delta H_{\text{bonds broken}}^{\circ} = 3200 \text{ kJ}$$

Product bonds formed:

$$1 \times \text{C-C} = (1 \text{ mol})(-347 \text{ kJ/mol}) = -347 \text{ kJ}$$

$$5 \times \text{C-H} = (5 \text{ mol})(-413 \text{ kJ/mol}) = -2065 \text{ kJ}$$

$$1 \times \text{C-O} = (1 \text{ mol})(-358 \text{ kJ/mol}) = -358 \text{ kJ}$$

$$1 \times \text{O-H} = (1 \text{ mol})(-467 \text{ kJ/mol}) = -467 \text{ kJ}$$

$$\Sigma \Delta H_{\text{bonds formed}}^{\circ} = -3237 \text{ kJ}$$

$$\Delta H_{\text{rxn}}^{\circ} = \Sigma \Delta H_{\text{bonds broken}}^{\circ} + \Sigma \Delta H_{\text{bonds formed}}^{\circ} = 3200 \text{ kJ} + (-3237 \text{ kJ}) = -37 \text{ kJ}$$

- 10.69 Determine the empirical formula from the percent composition (assuming 100 grams of compound). The empirical formula and the molar mass may then be used to determine the molecular formula. Count the valence electrons in the molecular formula and then construct the Lewis structure. Name the compound from its molecular formula.

$$\text{N} \quad 25.9 \text{ g}/(14.01 \text{ g/mol}) = 1.849 \text{ mol}/1.849 \text{ mol} = 1.00 \quad \text{Only round at the end.}$$

$$\text{O} \quad (100.0 - 25.9) \text{ g}/(16.00 \text{ g/mol}) = 4.631 \text{ mol}/1.849 \text{ mol} = 2.50$$

Doubling the ratios gives N = 2 and O = 5 or N<sub>2</sub>O<sub>5</sub> with a molar mass of 108.02 g/mol. Since this is the same as the molar mass given in the problem, the empirical and molecular formulas are both N<sub>2</sub>O<sub>5</sub>.

This formula has 40 valence electrons, and when drawn with no N-N or O-O bonds one gets the following Lewis structure:

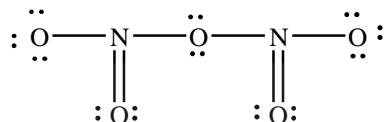

The name of this compound is **dinitrogen pentoxide**.

- 10.70 **Plan:** Determine the empirical formula from the percent composition (assuming 100 g of compound). Use the titration data to determine the mole ratio of acid to the NaOH. This ratio gives the number of acidic H atoms in the formula of the acid. Finally, combine this information to construct the Lewis structure.

**Solution:**

$$\text{Moles of H} = (2.24 \text{ g H}) \left( \frac{1 \text{ mol}}{1.008 \text{ g H}} \right) = 2.222 \text{ mol H}$$

$$\text{Moles of C} = (26.7 \text{ g C}) \left( \frac{1 \text{ mol}}{12.01 \text{ g C}} \right) = 2.223 \text{ mol C}$$

$$\text{Moles of O} = (71.1 \text{ g O}) \left( \frac{1 \text{ mol}}{16.00 \text{ g O}} \right) = 4.444 \text{ mol O}$$

The preliminary formula is  $\text{H}_{2.222}\text{C}_{2.223}\text{O}_{4.444}$ .

Dividing all subscripts by the smallest subscript to obtain integer subscripts:

$$\frac{\text{H}_{2.222}\text{C}_{2.223}\text{O}_{4.444}}{2.222} = \text{HCO}_2$$

The empirical formula is  $\text{HCO}_2$ .

Calculate the amount of NaOH required for the titration:

$$\text{Mmoles of NaOH} = (50.0 \text{ mL}) \left( \frac{1 \text{ L}}{1000 \text{ mL}} \right) \left( \frac{0.040 \text{ mol NaOH}}{\text{L}} \right) \left( \frac{1 \text{ mmol}}{0.001 \text{ mol}} \right) = 2.0 \text{ mmol NaOH}$$

Thus, the ratio is 2.0 mmole base/1.0 mmole acid, or each acid molecule has two hydrogen atoms to react (diprotic). The empirical formula indicates a monoprotic acid, so the formula must be doubled to:  $\text{H}_2\text{C}_2\text{O}_4$ .  $\text{H}_2\text{C}_2\text{O}_4$  has  $[2 \times \text{H}(1e^-)] + [2 \times \text{C}(4e^-)] + [4 \times \text{O}(6e^-)] = 34$  valence electrons to be used in the Lewis structure. Fourteen of these electrons are used to bond the atoms with single bonds, leaving  $34 - 14 = 20$  electrons or ten pairs of electrons. When these ten pairs of electrons are distributed to the atoms to complete octets, neither C atom has an octet; a lone pair from the oxygen without hydrogen is changed to a bonding pair on C.

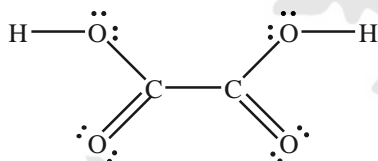

- 10.71 **Plan:** Draw the Lewis structure of the OH species. The standard enthalpy of formation is the sum of the energy required to break all the bonds in the reactants and the energy released to form all bonds in the product. Remember to use a negative sign for the energy of the bonds formed since bond formation is exothermic. The bond energy values are found in Table 9.2.

**Solution:**

a) The OH molecule has  $[1 \times \text{O}(6e^-)] + [1 \times \text{H}(1e^-)] = 7$  valence electrons to be used in the Lewis structure. Two of these electrons are used to bond the atoms with a single bond, leaving  $7 - 2 = 5$  electrons. Those five electrons are given to oxygen. But no atom can have an octet, and one electron is left unpaired. The Lewis structure is:

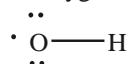

b) The formation reaction is:  $1/2\text{O}_2(g) + 1/2\text{H}_2(g) \rightarrow \text{OH}(g)$ . The heat of reaction is:

$$\Delta H_{\text{rxn}}^\circ = \sum \Delta H_{\text{bonds broken}}^\circ + \sum \Delta H_{\text{bonds formed}}^\circ = 39.0 \text{ kJ}$$

$$[1/2 (\text{BE}_{\text{O-O}}) + 1/2 (\text{BE}_{\text{H-H}})] + [\text{BE}_{\text{O-H}}] = 39.0 \text{ kJ}$$

$$[(1/2 \text{ mol})(498 \text{ kJ/mol}) + (1/2 \text{ mol})(432 \text{ kJ/mol})] + [\text{BE}_{\text{O-H}}] = 39.0 \text{ kJ}$$

$$465 \text{ kJ} + [\text{BE}_{\text{O-H}}] = 39.0 \text{ kJ}$$

$$\text{BE}_{\text{O-H}} = -426 \text{ kJ or } 426 \text{ kJ}$$

c) The average bond energy (from the bond energy table) is 467 kJ/mol. There are two O–H bonds in water for a total of  $2 \times 467 \text{ kJ/mol} = 934 \text{ kJ}$ . The answer to part b) accounts for 426 kJ of this, leaving:  
 $934 \text{ kJ} - 426 \text{ kJ} = \mathbf{508 \text{ kJ}}$

10.72 Both  $\text{N}_3^-$  and  $\text{HN}_3$  have sixteen valence electrons.

Azide ion:

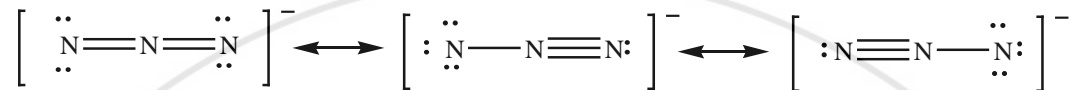

There are three resonance structures for the  $\text{N}_3^-$  ion. The formal charges in the first structure are, from left to right,  $-1$ ,  $+1$ , and  $-1$ . In the other two Lewis structures the single bonded N has a formal charge of  $-2$ , making both of these less stable than the first structure. The central N is  $+1$  and the triple bonded N is  $0$ . The first resonance structure is more important; the structure should have two equal bonds with a bond order of  $2$ .

Hydrazoic acid:

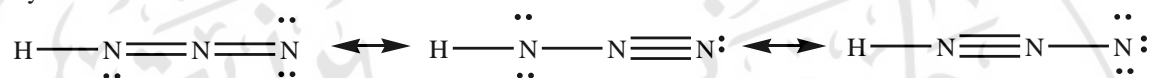

$\text{HN}_3$  also has three resonance structures. The formal charge for the H is  $0$  in all the structures. In the structure with two double bonds, the formal charges for the N atoms are, left to right:  $0$ ,  $+1$ , and  $-1$ . The structure where the H is attached to the single bonded N, has N atoms with the following formal charges:  $-1$ ,  $+1$ , and  $0$ . In the final Lewis structure, the formal charges on the N atoms are:  $+1$ ,  $+1$ , and  $-2$ . The third structure is clearly not as good as the other two. The first two structures should be averaged to give, starting at the H–end, a bond order of  $1.5$  then a bond order of  $2.5$ . Thus, the two bonds are unequal.

10.73 Plan: The basic Lewis structure will be the same for all species. The Cl atoms are larger than the F atoms. All of the molecules are of the type  $\text{AX}_5$  and have trigonal bipyramidal molecular shape. The equatorial positions are in the plane of the triangle and the axial positions above and below the plane of the triangle. In this molecular shape, there is more room in the equatorial positions.

Solution:

- a) The F atoms will occupy the smaller **axial positions** first so that the larger Cl atoms can occupy the equatorial positions which are less crowded.
- b) The molecule containing only F atoms is nonpolar (has no dipole moment), as all the polar bonds would cancel. The molecules with one F or one Cl would be polar since the P–F and P–Cl bonds are not equal in polarity and thus do not cancel each other. The presence of two axial F atoms means that their polarities will cancel (as would the three Cl atoms) giving a nonpolar molecule. The molecule with three F atoms is also polar.

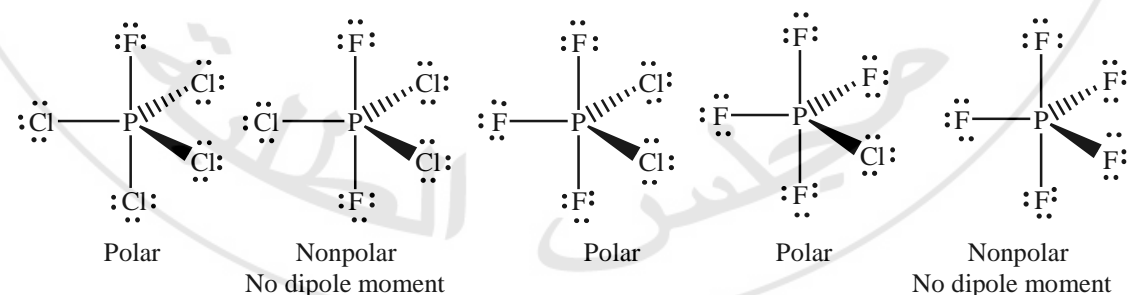

10.74  $\text{N}_2\text{O}$  has sixteen valence electrons; there are three resonance structures.

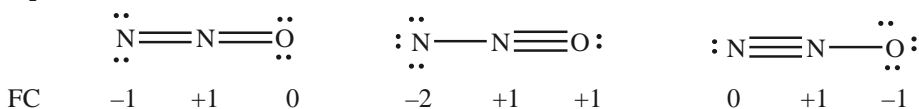

The third structure has a more reasonable distribution of formal charges. The third form has a strong triple bond between the N atoms and a weak N–O bond. It is easy to break the N–O bond which is why this compound easily decomposes to support combustion.

- 10.75 The molecule has forty-two valence electrons. Thirty electrons are already accounted for in the skeleton structure in the bonds.  $42 - 30 = 12$  valence electrons remain. If these twelve electrons are given to the two oxygen atoms to complete their octets, the carbon atom that is bonded to the two oxygen atoms does not have an octet. A lone pair from one of the oxygen atoms is changed to a bonding pair on the C. All the atoms have 0 formal charge except the N (FC = +1), and the single bonded O (FC = -1)

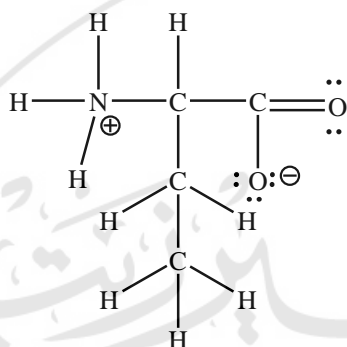

- 10.76 a) **Yes**, the black sphere can represent selenium.  $\text{SeF}_4$  has thirty-four valence electrons. Eight of these electrons are used in the four Se–F single bonds and twenty-four electrons are used to complete the octets of the F atoms. The remaining electron pair goes to selenium and the molecule is  $\text{AX}_4\text{E}$ . The molecular geometry is the seesaw molecular shape shown.
- b) **Yes**, the black sphere can represent nitrogen if the species is an anion with a -1 charge. The  $\text{NF}_4^-$  ion has thirty-four valence electrons and would have the seesaw molecular shape as an  $\text{AX}_4\text{E}$  species.
- c) For  $\text{BrF}_4$  to have the thirty-four valence electrons needed for this seesaw molecular geometry, the charge of the species must be +1.  $\text{BrF}_4^+$  would have  $[1 \times \text{Br}(7e^-)] + [4 \times \text{F}(7e^-)] - [1e^- \text{ from } + \text{ charge}] = 34$  valence electrons.
- 10.77 **Plan:** Draw the Lewis structures. Calculate the heat of reaction using the bond energies in Table 9.2.

**Solution:**

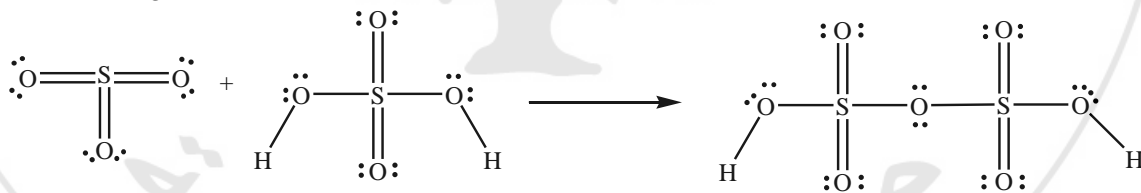
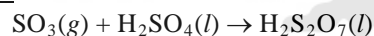

Reactant bonds broken:

$$5 \times \text{S}=\text{O} = (5 \text{ mol})(552 \text{ kJ/mol}) = 2760 \text{ kJ}$$

$$2 \times \text{S}-\text{O} = (2 \text{ mol})(265 \text{ kJ/mol}) = 530 \text{ kJ}$$

$$2 \times \text{O}-\text{H} = (2 \text{ mol})(467 \text{ kJ/mol}) = 934 \text{ kJ}$$

$$\Sigma \Delta H_{\text{bonds broken}}^{\circ} = 4224 \text{ kJ}$$

Product bonds formed:

$$4 \times \text{S}=\text{O} = (4 \text{ mol})(-552 \text{ kJ/mol}) = -2208 \text{ kJ}$$

$$4 \times \text{S}-\text{O} = (4 \text{ mol})(-265 \text{ kJ/mol}) = -1060 \text{ kJ}$$

$$2 \times \text{O}-\text{H} = (2 \text{ mol})(-467 \text{ kJ/mol}) = -934 \text{ kJ}$$

$$\Sigma \Delta H_{\text{bonds formed}}^{\circ} = -4202 \text{ kJ}$$

$$\Delta H_{\text{rxn}}^{\circ} = \Sigma \Delta H_{\text{bonds broken}}^{\circ} + \Sigma \Delta H_{\text{bonds formed}}^{\circ} = 4224 \text{ kJ} + (-4202 \text{ kJ}) = \mathbf{22 \text{ kJ}}$$



- 10.78 Draw the 2 Lewis structures, and then apply VSEPR to predict the angles.

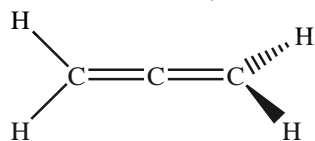

There are no deviations from the ideal angles. The central carbon is linear ( $180^\circ$ ). The end C atoms are trigonal planar ( $120^\circ$ ).

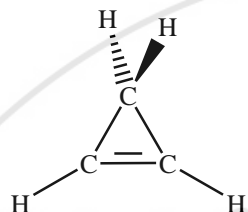

Ideally, the single bonded carbon should be tetrahedral ( $109.5^\circ$ ), and the double bonded carbons are trigonal planar ( $120^\circ$ ). The 3-membered ring will approximate an equilateral triangle with  $60^\circ$  angles. The external bonds are probably close to ideal, but the internal bonds are much less.

- 10.79 Plan: Pick the VSEPR structures for  $AY_3$  substances. Then determine which are polar.

Solution:

The molecular shapes that have a central atom bonded to three other atoms are trigonal planar, trigonal pyramidal, and T shaped:

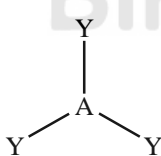

a)  
three groups  
( $AX_3$ )  
trigonal planar



b)  
four groups  
( $AX_3E$ )  
trigonal pyramidal

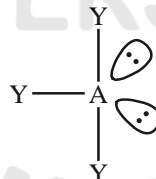

c)  
five groups  
( $AX_3E_2$ )  
T shaped

Trigonal planar molecules, such as a), are nonpolar, so it cannot be  $AY_3$ . Trigonal pyramidal molecules b) and T-shaped molecules c) are polar, so either could represent  $AY_3$ .

- 10.80 Draw the resonance structures for the fulminate ion, and determine the formal charges:

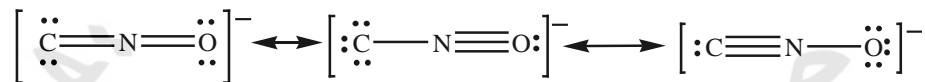

F.C.      -2    +1    0            -3    +1    +1            -1    +1    -1

None of the structures has a good distribution of formal charges, thus, none are stable. The best of the choices is the middle structure.

- 10.81 a) Shape A is T shaped ( $AX_3E_2$ ); Shape B is trigonal planar ( $AX_3$ ); Shape C is trigonal pyramid ( $AX_3E$ ).  $XeF_3^+$ , with twenty-eight valence electrons, has two unshared pairs on Xe and is  $AX_3E_2$  and is the T-shaped molecular shape in A.  $SbBr_3$ , with twenty-six valence electrons, has one unshared pair on Sb; thus it is  $AX_3E$  and is the trigonal pyramidal molecular shape in C.  $GaCl_3$ , with twenty-four valence electrons, has no unshared pairs on Ga; thus it is  $AX_3$  and is the trigonal planar shape in B.  
b) Shapes **A and C** are polar.  
c) Shape **A**, which is T-shaped, has the most valence electrons (ten) around the central atom.

10.82 The simplified Lewis structures for the reaction are:

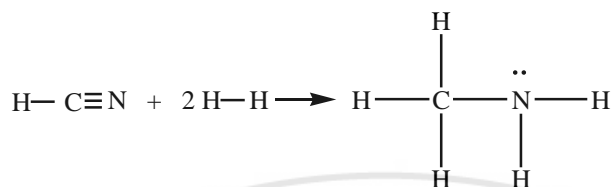

Reactant bonds broken:

$$1 \times \text{C}-\text{H} = (1 \text{ mol})(413 \text{ kJ/mol}) = 413 \text{ kJ}$$

$$1 \times \text{C}\equiv\text{N} = (1 \text{ mol})(891 \text{ kJ/mol}) = 891 \text{ kJ}$$

$$2 \times \text{H}-\text{H} = (2 \text{ mol})(432 \text{ kJ/mol}) = 864 \text{ kJ}$$

$$\Sigma\Delta H_{\text{bonds broken}}^{\circ} = 2168 \text{ kJ}$$

Product bonds formed:

$$3 \times \text{C}-\text{H} = (3 \text{ mol})(-413 \text{ kJ/mol}) = -1239 \text{ kJ}$$

$$1 \times \text{C}-\text{N} = (1 \text{ mol})(-305 \text{ kJ/mol}) = -305 \text{ kJ}$$

$$2 \times \text{N}-\text{H} = (2 \text{ mol})(-391 \text{ kJ/mol}) = -782 \text{ kJ}$$

$$\Sigma\Delta H_{\text{bonds formed}}^{\circ} = -2326 \text{ kJ}$$

$$\Delta H_{\text{rxn}}^{\circ} = \Sigma\Delta H_{\text{bonds broken}}^{\circ} + \Sigma\Delta H_{\text{bonds formed}}^{\circ} = 2168 \text{ kJ} + (-2326 \text{ kJ}) = -158 \text{ kJ}$$

10.83 a)

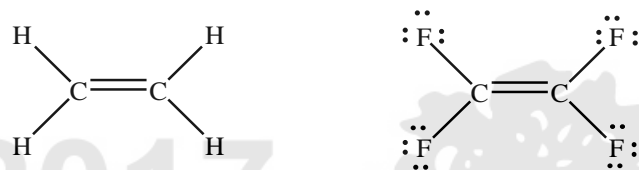

All the carbons are trigonal planar so the ideal angles should all be  $120^{\circ}$ .

b) The observed angles are slightly less than ideal because the  $\text{C}=\text{C}$  bond repels better than the single bonds. The larger F atoms cannot get as close together as the smaller H atoms, so the angles in tetrafluoroethylene are not reduced as much.

10.84 The top portions of the molecules are similar; therefore the top portions will interact with biomolecules in a similar manner.

10.85

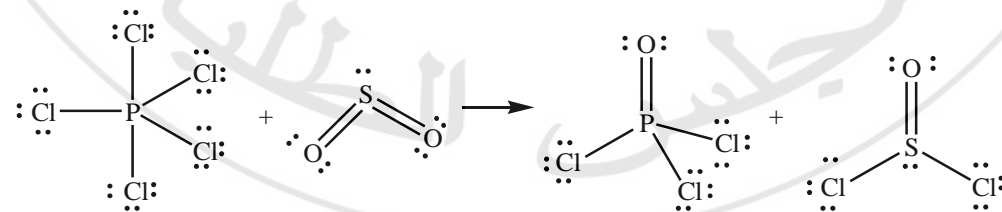
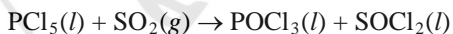

$\text{PCl}_5$ :  $\text{AX}_5$  **trigonal bipyramidal**

$\text{SO}_2$ :  $\text{AX}_2\text{E}$  **bent**

$\text{POCl}_3$ :  $\text{AX}_4$  **tetrahedral**

$\text{SOCl}_2$ :  $\text{AX}_3\text{E}$  **trigonal pyramidal**

# CHAPTER 11 THEORIES OF COVALENT BONDING

## END-OF-CHAPTER PROBLEMS

- 11.1 **Plan:** Table 11.1 describes the types of hybrid orbitals that correspond to the various electron-group arrangements. The number of hybrid orbitals formed by a central atom is equal to the number of electron groups arranged around that central atom.  
**Solution:**  
a) trigonal planar: three electron groups - three hybrid orbitals:  $sp^2$   
b) octahedral: six electron groups - six hybrid orbitals:  $sp^3d^2$   
c) linear: two electron groups - two hybrid orbitals:  $sp$   
d) tetrahedral: four electron groups - four hybrid orbitals:  $sp^3$   
e) trigonal bipyramidal: five electron groups - five hybrid orbitals:  $sp^3d$
- 11.2 a)  $sp^2$  b)  $sp^3$  c)  $sp^3d$  d)  $sp^3d^2$
- 11.3 Carbon and silicon have the same number of valence electrons, but the outer level of electrons is  $n = 2$  for carbon and  $n = 3$  for silicon. Thus, silicon has  $3d$  orbitals in addition to  $3s$  and  $3p$  orbitals available for bonding in its outer level, to form up to six hybrid orbitals, whereas carbon has only  $2s$  and  $2p$  orbitals available in its outer level to form up to four hybrid orbitals.
- 11.4 **Four.** The same number of hybrid orbitals will form as the initial number of atomic orbitals mixed.
- 11.5 **Plan:** The number of hybrid orbitals is the same as the number of atomic orbitals before hybridization. The type depends on the orbitals mixed. The name of the type of hybrid orbital comes from the number and type of atomic orbitals mixed. The number of each type of atomic orbital appears as a superscript in the name of the hybrid orbital.  
**Solution:**  
a) There are six unhybridized orbitals, and therefore **six** hybrid orbitals result. The type is  $sp^3d^2$  since one  $s$ , three  $p$ , and two  $d$  atomic orbitals were mixed.  
b) **Four**  $sp^3$  hybrid orbitals form from three  $p$  and one  $s$  atomic orbitals.
- 11.6 a) **two  $sp$  orbitals**                                      b) **five  $sp^3d$  orbitals**
- 11.7 **Plan:** To determine hybridization, draw the Lewis structure and count the number of electron groups around the central nitrogen atom. Hybridize that number of orbitals. Single, double, and triple bonds all count as one electron group. An unshared pair (lone pair) of electrons or one unshared electron also counts as one electron group.  
**Solution:**  
a) The three electron groups (one double bond, one lone pair, and one unpaired electron) around nitrogen require three hybrid orbitals. The hybridization is  $sp^2$ .

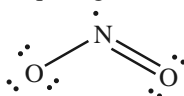
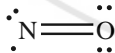

c) The nitrogen has three electron groups (one single bond, one double bond, and one lone pair) so the hybridization is  $sp^2$ .

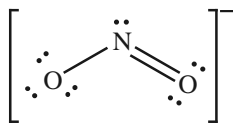

11.8 a)  $sp^2$

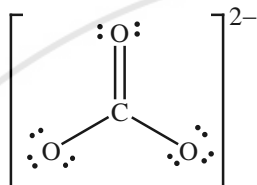

b)  $sp^2$

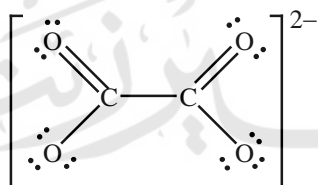

c)  $sp$

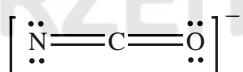

11.9 Plan: To determine hybridization, draw the Lewis structure and count the number of electron groups around the central chlorine atom. Hybridize that number of orbitals. Single, double, and triple bonds all count as one electron group. An unshared pair (lone pair) of electrons or one unshared electron also counts as one electron group.

Solution:

a) The Cl has four electron groups (one lone pair, one lone electron, and two double bonds) and therefore four hybrid orbitals are required; the hybridization is  $sp^3$ . Note that in  $\text{ClO}_2$ , the  $\pi$  bond is formed by the overlap of  $d$  orbitals from chlorine with  $p$  orbitals from oxygen.

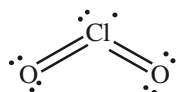

b) The Cl has four electron groups (one lone pair and three bonds) and therefore four hybrid orbitals are required; the hybridization is  $sp^3$ .

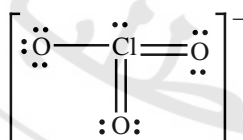

c) The Cl has four electron groups (four bonds) and therefore four hybrid orbitals are required; the hybridization is  $sp^3$ .

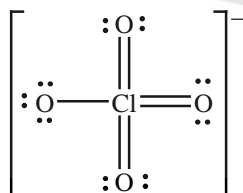

11.10 a)  $sp^3d$

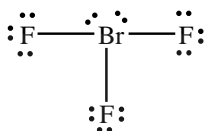

b)  $sp^3$

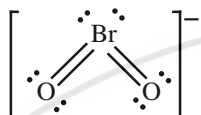

c)  $sp^3d^2$

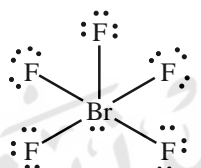

11.11 Plan: Draw the Lewis structure and count the number of electron groups around the central atom. Hybridize that number of orbitals. Single, double, and triple bonds all count as one electron group. An unshared pair (lone pair) of electrons or one unshared electron also counts as one electron group. Once the type of hybridization is known, the types of atomic orbitals that will mix to form those hybrid orbitals are also known.

Solution:

a) Silicon has four electron groups (four bonds) requiring four hybrid orbitals; four  $sp^3$  hybrid orbitals are made from **one  $s$  and three  $p$  atomic orbitals**.

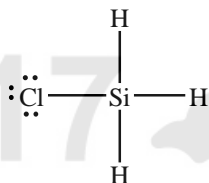

b) Carbon has two electron groups (two double bonds) requiring two hybrid orbitals; two  $sp$  hybrid orbitals are made from **one  $s$  and one  $p$  orbital**.

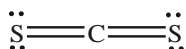

c) Sulfur is surrounded by five electron groups (four bonding pairs and one lone pair), requiring five hybrid orbitals; five  $sp^3d$  hybrid orbitals are formed from **one  $s$  orbital, three  $p$  orbitals, and one  $d$  orbital**.

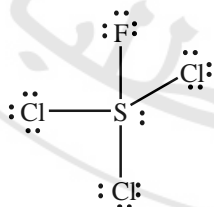

d) Nitrogen is surrounded by four electron groups (three bonding pairs and one lone pair) requiring four hybrid orbitals; four  $sp^3$  hybrid orbitals are formed from **one  $s$  orbital and three  $p$  orbitals**.

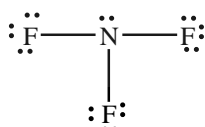

11.12 a)  $sp^3 \leftarrow s + 3p$

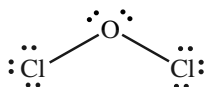

b)  $sp^3d \leftarrow s + 3p + d$

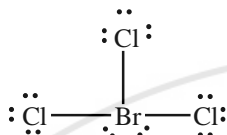

c)  $sp^3d \leftarrow s + 3p + d$

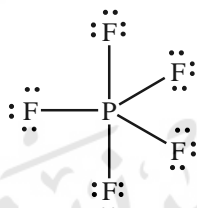

d)  $sp^3 \leftarrow s + 3p$

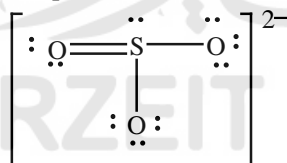

11.13 Plan: To determine hybridization, draw the Lewis structure of the reactants and products and count the number of electron groups around the central atom. Hybridize that number of orbitals. Single, double, and triple bonds all count as one electron group. An unshared pair (lone pair) of electrons or one unshared electron also counts as one electron group. Recall that  $sp$  hybrid orbitals are oriented in a linear geometry,  $sp^2$  in a trigonal planar geometry,  $sp^3$  in a tetrahedral geometry,  $sp^3d$  in a trigonal bipyramidal geometry, and  $sp^3d^2$  in an octahedral geometry.

Solution:

a) The P in  $\text{PH}_3$  has four electron groups (one lone pair and three bonds) and therefore four hybrid orbitals are required; the hybridization is  $sp^3$ . The P in the product also has four electron groups (four bonds) and again four hybrid orbitals are required. The hybridization of P remains  $sp^3$ . There is no change in hybridization. Illustration B best shows the hybridization of P during the reaction as  $sp^3 \rightarrow sp^3$ .

b) The B in  $\text{BH}_3$  has three electron groups (three bonds) and therefore three hybrid orbitals are required; the hybridization is  $sp^2$ . The B in the product has four electron groups (four bonds) and four hybrid orbitals are required. The hybridization of B is now  $sp^3$ . The hybridization of B changes from  $sp^2$  to  $sp^3$ ; this is best shown by illustration A.

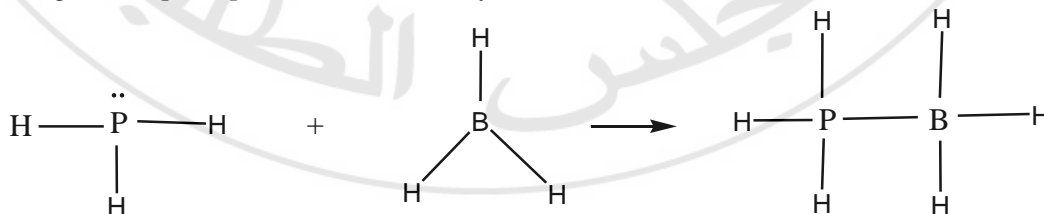

- 11.14 a) The Te in  $\text{TeF}_6$  has six electron groups (six bonds) and therefore six hybrid orbitals are required; the hybridization is  $sp^3d^2$ . Te in  $\text{TeF}_5^-$  also has six electron groups (five bonds and one unshared pair) and again six hybrid orbitals are required. The hybridization of Te remains  $sp^3d^2$ . There is no change in hybridization. Illustration A best shows the hybridization of Te when  $\text{TeF}_6$  forms  $\text{TeF}_5^-$ :  $sp^3d^2 \rightarrow sp^3d^2$ .

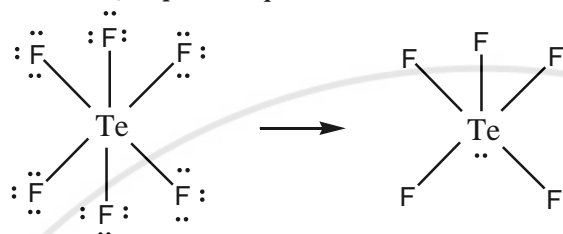

- b) The Te in  $\text{TeF}_4$  has five electron groups (four bonds and one unshared pair) and therefore five hybrid orbitals are required; the hybridization is  $sp^3d$ . Te in  $\text{TeF}_6$  has six electron groups (six bonds) and therefore six hybrid orbitals are required; the hybridization is  $sp^3d^2$ . Illustration C best shows the change in hybridization of Te from  $sp^3d$  to  $sp^3d^2$ .

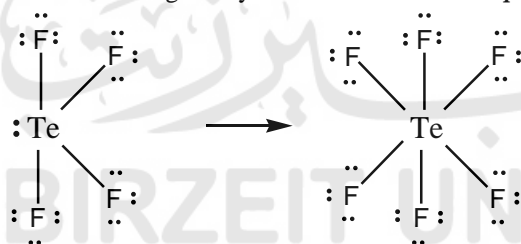

- 11.15 Plan: To determine hybridization, draw the Lewis structure and count the number of electron groups around the central atom. Hybridize that number of orbitals. Single, double, and triple bonds all count as one electron group. An unshared pair (lone pair) of electrons or one unshared electron also counts as one electron group. Write the electron configuration of the central atom and mix the appropriate atomic orbitals to form the hybrid orbitals.

Solution:

- a) Germanium is the central atom in  $\text{GeCl}_4$ . Its electron configuration is  $[\text{Ar}]4s^23d^{10}4p^2$ . Ge has four electron groups (four bonds), requiring four hybrid orbitals. Hybridization is  $sp^3$  around Ge. One of the  $4s$  electrons is moved to a  $4p$  orbital and the four orbitals are hybridized.

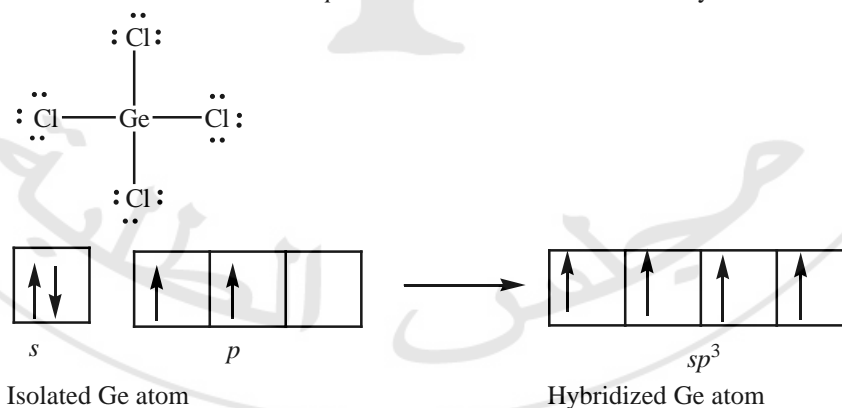

b) Boron is the central atom in  $\text{BCl}_3$ . Its electron configuration is  $[\text{He}]2s^2 2p^1$ . B has three electron groups (three bonds), requiring three hybrid orbitals. Hybridization is  $sp^2$  around B. One of the  $2s$  electrons is moved to an empty  $2p$  orbital and the three atomic orbitals are hybridized. One of the  $2p$  atomic orbitals is not involved in the hybridization.

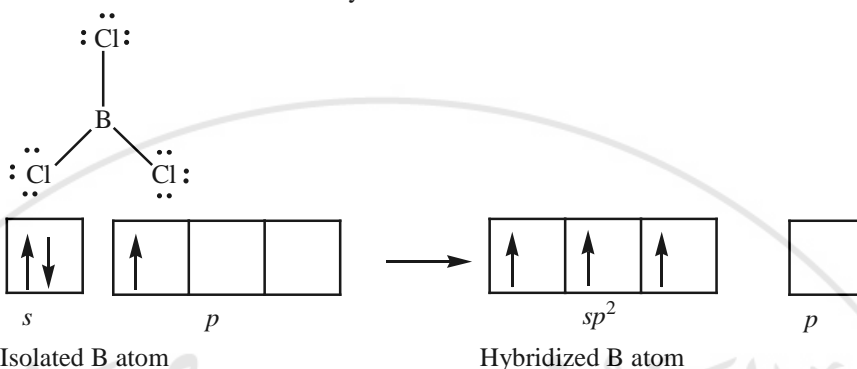

c) Carbon is the central atom in  $\text{CH}_3^+$ . Its electron configuration is  $[\text{He}]2s^2 2p^2$ . C has three electron groups (three bonds), requiring three hybrid orbitals. Hybridization is  $sp^2$  around C. One of the  $2s$  electrons is moved to an empty  $2p$  orbital; three orbitals are hybridized and one electron is removed to form the +1 ion.

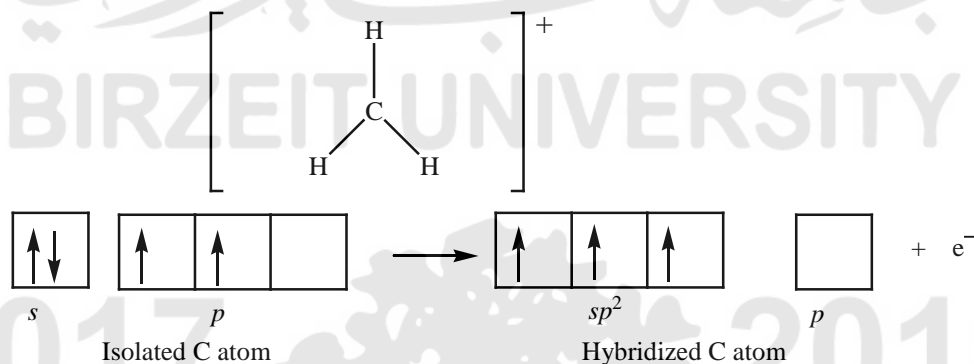

11.16

a)

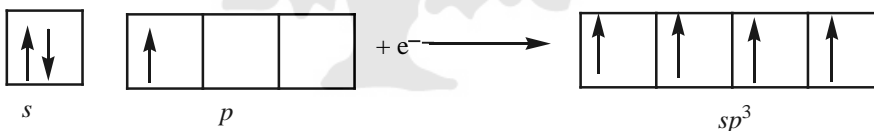

b)

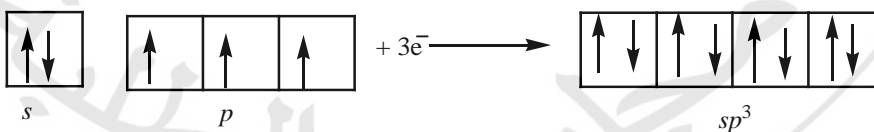

c)

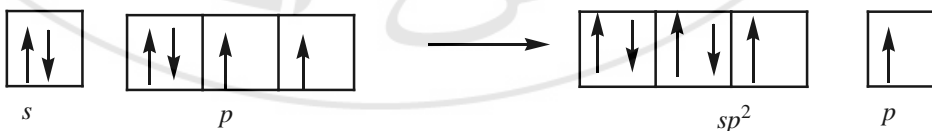



11.17 **Plan:** To determine hybridization, draw the Lewis structure and count the number of electron groups around the central atom. Hybridize that number of orbitals. Single, double, and triple bonds all count as one electron group. An unshared pair (lone pair) of electrons or one unshared electron also counts as one electron group. Write the electron configuration of the central atom and mix the appropriate atomic orbitals to form the hybrid orbitals.

**Solution:**

a) In  $\text{SeCl}_2$ , Se is the central atom and has four electron groups (two single bonds and two lone pairs), requiring four hybrid orbitals so Se is  $sp^3$  hybridized. The electron configuration of Se is  $[\text{Ar}]4s^23d^{10}4p^4$ . The  $4s$  and  $4p$  atomic orbitals are hybridized. Two  $sp^3$  hybrid orbitals are filled with lone electron pairs and two  $sp^3$  orbitals bond with the chlorine atoms.

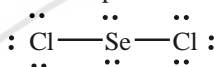

b) In  $\text{H}_3\text{O}^+$ , O is the central atom and has four electron groups (three single bonds and one lone pair), requiring four hybrid orbitals. O is  $sp^3$  hybridized. The electron configuration of O is  $[\text{He}]2s^22p^4$ . The  $2s$  and  $2p$  orbitals are hybridized. One  $sp^3$  hybrid orbital is filled with a lone electron pair and three  $sp^3$  orbitals bond with the hydrogen atoms.

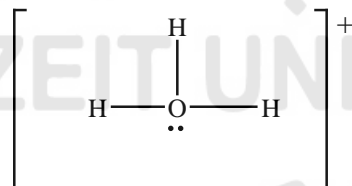

c) I is the central atom in  $\text{IF}_4^-$  with six electron groups (four single bonds and two lone pairs) surrounding it. Six hybrid orbitals are required and I has  $sp^3d^2$  hybrid orbitals. The  $sp^3d^2$  hybrid orbitals are composed of one  $s$  orbital, three  $p$  orbitals, and two  $d$  orbitals. Two  $sp^3d^2$  orbitals are filled with a lone pair and four  $sp^3d^2$  orbitals bond with the fluorine atoms.

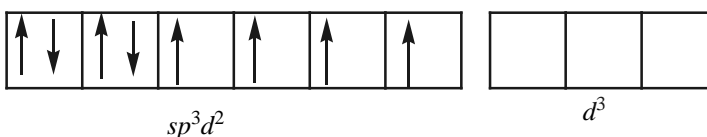
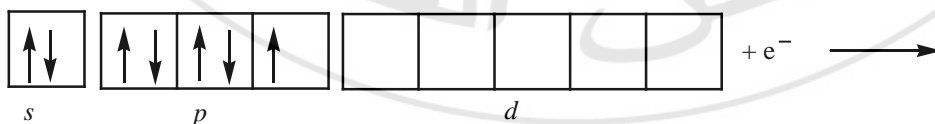
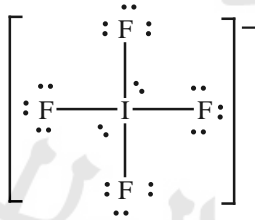

11.18 a)



b)

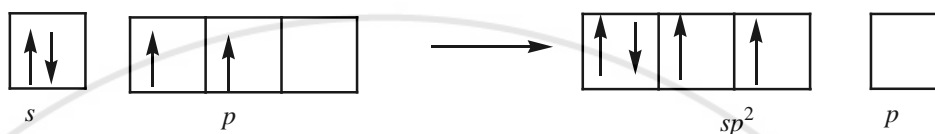

c)

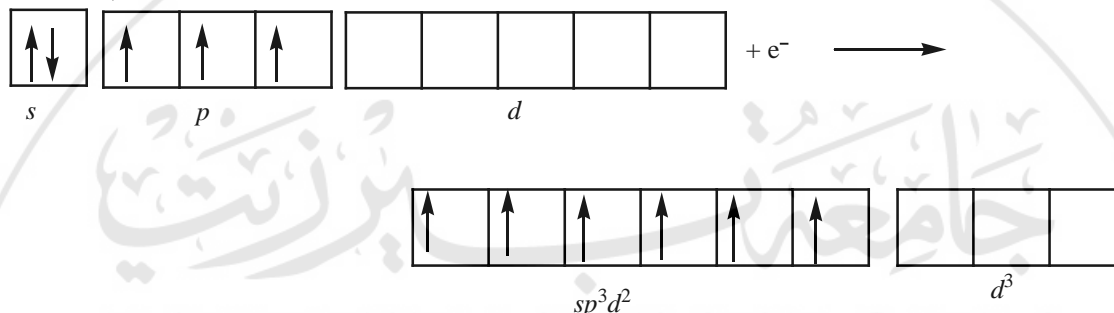

11.19

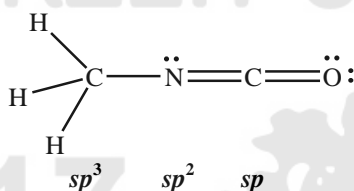

11.20 **Plan:** A single bond is a sigma bond which is the result of two orbitals overlapping end to end; a double bond consists of one sigma bond and one pi bond; and a triple bond consists of one sigma bond and two pi bonds. A pi bond is the result of orbitals overlapping side to side.

**Solution:**

- a) **False**, a double bond is one sigma ( $\sigma$ ) and one pi ( $\pi$ ) bond.
- b) **False**, a triple bond consists of one sigma ( $\sigma$ ) and two pi ( $\pi$ ) bonds.
- c) **True**
- d) **True**
- e) **False**, a  $\pi$  bond consists of one pair of electrons; it occurs after a  $\sigma$  bond has been previously formed.
- f) **False**, end-to-end overlap results in a bond with electron density along the bond axis.

11.21 **Plan:** To determine hybridization, draw the Lewis structure and count the number of electron groups around the central atom. Hybridize that number of orbitals. Single, double, and triple bonds all count as one electron group. An unshared pair (lone pair) of electrons or one unshared electron also counts as one electron group. A single bond is a sigma bond which is the result of two orbitals overlapping end to end; a double bond consists of one sigma bond and one pi bond; and a triple bond consists of one sigma bond and two pi bonds.

**Solution:**

- a) Nitrogen is the central atom in  $\text{NO}_3^-$ . Nitrogen has three surrounding electron groups (two single bonds and one double bond), so it is  $sp^2$  hybridized. Nitrogen forms **three  $\sigma$  bonds** (one each for the N–O bonds) and **one  $\pi$  bond** (part of the N=O double bond).

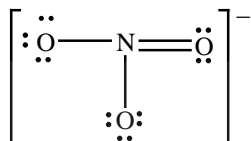

b) Carbon is the central atom in  $\text{CS}_2$ . Carbon has two surrounding electron groups (two double bonds), so it is  $sp$  hybridized. Carbon forms **two  $\sigma$  bonds** (one each for the C–S bonds) and **two  $\pi$  bonds** (part of the two C=S double bonds).

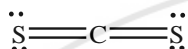

c) Carbon is the central atom in  $\text{CH}_2\text{O}$ . Carbon has three surrounding electron groups (two single bonds and one double bond), so it is  $sp^2$  hybridized. Carbon forms **three  $\sigma$  bonds** (one each for the two C–H bonds and one C–O bond) and **one  $\pi$  bond** (part of the C=O double bond).

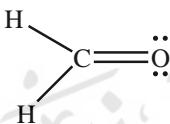

11.22 a)  $sp^2$  **2  $\sigma$  bonds and 1  $\pi$  bond**

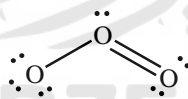

b)  $sp^3d$  **2  $\sigma$  bonds**

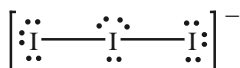

c)  $sp^2$  **3  $\sigma$  bond and 1  $\pi$  bond**

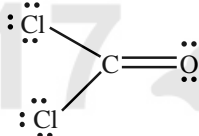

11.23 Plan: To determine hybridization, draw the Lewis structure and count the number of electron groups around the central nitrogen atom. Hybridize that number of orbitals. Single, double, and triple bonds all count as one electron group. An unshared pair (lone pair) of electrons or one unshared electron also counts as one electron group. A single bond is a sigma bond which is the result of two orbitals overlapping end to end; a double bond consists of one sigma bond and one pi bond; and a triple bond consists of one sigma bond and two pi bonds.

Solution:

a) In FNO, three electron groups (one lone pair, one single bond, and one double bond) surround the central N atom. Hybridization is  $sp^2$  around nitrogen. One sigma bond exists between F and N, and one sigma and one pi bond exist between N and O. Nitrogen participates in a total of **2  $\sigma$  and 1  $\pi$  bonds**.

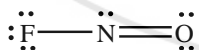

b) In  $\text{C}_2\text{F}_4$ , each carbon has three electron groups (two single bonds and one double bond) with  $sp^2$  hybridization. The bonds between C and F are sigma bonds. The C–C bond consists of one sigma and one pi bond. Each carbon participates in a total of **three  $\sigma$  bonds and one  $\pi$  bond**.

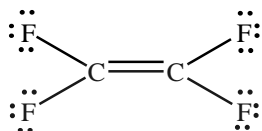

c) In  $(\text{CN})_2$ , each carbon has two electron groups (one single bond and one triple bond) and is  $sp$  hybridized with a sigma bond between the two carbons and a sigma and two pi bonds comprising each C–N triple bond. Each carbon participates in a total of **two  $\sigma$  and two  $\pi$  bonds**.



11.24 a)  $sp^3d$  **three  $\sigma$  bonds**

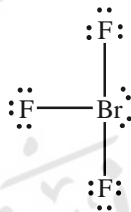

b)  $sp^3$  ( $\text{CH}_3$ )  $sp$  (other two C atoms) **six  $\sigma$  and two  $\pi$  bonds**

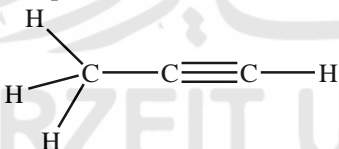

c)  $sp^2$  **two  $\sigma$  and two  $\pi$  bonds**

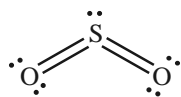

11.25 Four molecular orbitals form from the four  $p$  atomic orbitals. In forming molecular orbitals, the total number of molecular orbitals must equal the number of atomic orbitals. Two of the four molecular orbitals formed are bonding orbitals and two are antibonding.

11.26 Two  $p_x$  atomic orbitals were used to form a sigma bonding MO (lower energy) and a sigma antibonding MO (higher energy). The bonding MO does not have a node separating the two halves of the orbital.

11.27 a) Bonding MOs have lower energy than antibonding MOs. The bonding MO's lower energy, even lower than its constituent atomic orbitals, accounts for the stability of a molecule in relation to its individual atoms. However, the sum of energy of the MOs must equal the sum of energy of the AOs.

b) The node is the region of an orbital where the probability of finding the electron is zero, so the nodal plane is the plane that bisects the node perpendicular to the bond axis. There is no node along the bond axis (probability is positive between the two nuclei) for the bonding MO. The antibonding MO does have a nodal plane.

c) The bonding MO has higher electron density between nuclei than the antibonding MO.

11.28 A bonding MO may contain a nodal plane lying along the internuclear axis, as in  $\pi$  bonding. In an antibonding MO, the nodal plane is perpendicular to the bond axis, between the atoms.

11.29 Plan: Like atomic orbitals, any one MO holds a maximum of two electrons. Two atomic orbitals combine to form two molecular orbitals, a bonding and an antibonding MO.

Solution:

- a) **Two** electrons are required to fill a  $\sigma$ -bonding molecular orbital. Each molecular orbital requires two electrons.
- b) **Two** electrons are required to fill a  $\pi$ -antibonding molecular orbital. There are two  $\pi$ -antibonding orbitals, each holding a maximum of two electrons.
- c) **Four** electrons are required to fill the two  $\sigma$  molecular orbitals (two electrons to fill the  $\sigma$ -bonding and two to fill the  $\sigma$ -antibonding) formed from two  $1s$  atomic orbitals.

11.30 a) **twelve** b) **two** c) **four**

11.31 Plan: Recall that a bonding MO has a region of high electron density between the nuclei while an antibonding MO has a node, or region of zero electron density between the nuclei. MOs formed from  $s$  orbitals, or from  $p$  orbitals overlapping end to end, are called  $\sigma$  and MOs formed by the side-to-side overlap of  $p$  orbitals are called  $\pi$ . A superscript star (\*) is used to designate an antibonding MO. To write the electron configuration of  $F_2^+$ , determine the number of valence electrons and write the sequence of MO energy levels, following the sequence order given in the text.

Solution:

a) A is the  $\pi^*_{2p}$  molecular orbital (two  $p$  orbitals overlapping side to side with a node between them); B is the  $\sigma_{2p}$  molecular orbital (two  $p$  orbitals overlapping end to end with no node); C is the  $\pi_{2p}$  molecular orbital (two  $p$  orbitals overlapping side to side with no node); D is the  $\sigma^*_{2p}$  molecular orbital (two  $p$  orbitals overlapping end to end with a node).

b)  $F_2^+$  has thirteen valence electrons:  $[2 \times F(7e^-) - 1 \text{ (from + charge)}]$ . The MO electron configuration is  $(\sigma_{2s})^2(\sigma^*_{2s})^2(\sigma_{2p})^2(\pi_{2p})^2(\pi_{2p})^2(\pi^*_{2p})^2(\pi^*_{2p})^1$ . The  $\pi^*_{2p}$  molecular orbital, A,  $\sigma_{2p}$  molecular orbital, B, and  $\pi_{2p}$  molecular orbital, C, are all occupied by at least one electron. The  $\sigma^*_{2p}$  molecular orbital is unoccupied.

c) A  $\pi^*_{2p}$  molecular orbital, A, has only one electron.

- 11.32 a) A is the  $\pi^*_{2p}$  molecular orbital; B is the  $\sigma_{2p}$  molecular orbital; C is the  $\pi_{2p}$  molecular orbital; D is the  $\sigma^*_{2p}$  molecular orbital; E is the  $\sigma_{2s}$  molecular orbital; F is the  $\sigma^*_{2s}$  molecular orbital.
- b) The  $\sigma^*_{2p}$  molecular orbital, D, is the highest in energy.
- c) The  $\sigma_{2s}$  molecular orbital, E, is the lowest in energy.
- d)  $\sigma_{2s} < \sigma^*_{2s} < \pi_{2p} < \sigma_{2p} < \pi^*_{2p} < \sigma^*_{2p}$  ( $E < F < C < B < A < D$ )

11.33 The horizontal line in all cases represents the bond axis.

a) Bonding  $s + p$



Antibonding  $s - p$

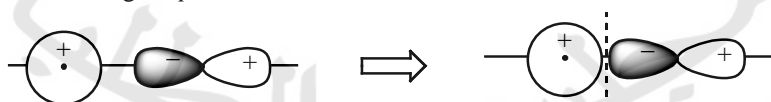

b) Bonding  $p + p$



Antibonding  $p - p$

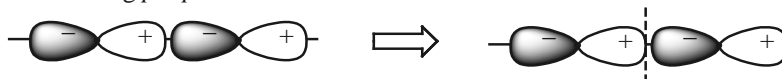

11.34 a)  
 $s + s =$



Bonding

$s - s =$



Antibonding

b)  
 $p + p =$

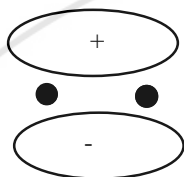

Bonding

$p - p =$

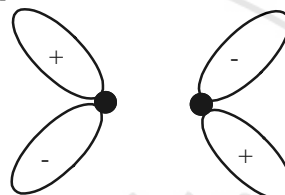

Antibonding

11.35 Plan: To write the electron configuration of  $\text{Be}_2^+$ , determine the number of electrons and write the sequence of MO energy levels, following the sequence order given in the text.  
 Bond order =  $\frac{1}{2}[(\text{no. of electrons in bonding MO}) - (\text{no. of electrons in antibonding MO})]$ . Recall that a diamagnetic substance has no unpaired electrons.

Solution:

a)  $\text{Be}_2^+$  has a total of seven electrons [ $2 \times \text{Be}(4e^-) - 1$  (from + charge)]. The molecular orbital configuration is  $(\sigma_{1s})^2(\sigma_{1s}^*)^2(\sigma_{2s})^2(\sigma_{2s}^*)^1$  and bond order =  $\frac{1}{2}(4 - 3) = 1/2$ . With a bond order of  $1/2$  the  $\text{Be}_2^+$  ion will be **stable**.

b) No, the ion has one unpaired electron in the  $\sigma_{2s}^*$  MO, so it is **paramagnetic**, not diamagnetic.

c) Valence electrons would be those in the molecular orbitals at the  $n = 2$  level, so the valence electron configuration is  $(\sigma_{2s})^2(\sigma_{2s}^*)^1$ .

11.36 a) The molecular orbital configuration for  $\text{O}_2^-$  with a total of seventeen electrons is  $(\sigma_{1s})^2(\sigma_{1s}^*)^2(\sigma_{2s})^2(\sigma_{2s}^*)^2(\sigma_{2p})^2(\pi_{2p})^2(\pi_{2p})^2(\pi_{2p}^*)^2(\pi_{2p}^*)^1$ .

Bond order =  $\frac{1}{2}(10 \text{ bonding} - 7 \text{ antibonding } e^-) = 3/2 = 1.5$ .  $\text{O}_2^-$  is **stable**.

b)  $\text{O}_2^-$  is **paramagnetic** with an unpaired electron in the  $\pi_{2p}^*$  MO.

c)  $(\sigma_{2s})^2(\sigma_{2s}^*)^2(\sigma_{2p})^2(\pi_{2p})^2(\pi_{2p})^2(\pi_{2p}^*)^2(\pi_{2p}^*)^1$

11.37 Plan: Write the electron configuration of each species by determining the number of electrons and writing the sequence of MO energy levels, following the sequence order given in the text.  
 Calculate the bond order: bond order =  $\frac{1}{2}[(\text{no. of electrons in bonding MO}) - (\text{no. of electrons in antibonding MO})]$ . Bond energy increases as bond order increases; bond length decreases as bond order increases.

Solution:

$\text{C}_2^-$  Total electrons =  $6 + 6 + 1 = 13$

MO configuration:  $(\sigma_{1s})^2(\sigma_{1s}^*)^2(\sigma_{2s})^2(\sigma_{2s}^*)^2(\pi_{2p})^4(\sigma_{2p})^1$

Bond order =  $1/2(9 - 4) = 2.5$

$\text{C}_2$  Total electrons =  $6 + 6 = 12$

MO configuration:  $(\sigma_{1s})^2(\sigma_{1s}^*)^2(\sigma_{2s})^2(\sigma_{2s}^*)^2(\pi_{2p})^4$

Bond order =  $1/2(8 - 4) = 2$

$\text{C}_2^+$  Total electrons =  $6 + 6 - 1 = 11$

MO configuration:  $(\sigma_{1s})^2(\sigma_{1s}^*)^2(\sigma_{2s})^2(\sigma_{2s}^*)^2(\pi_{2p})^3$

Bond order =  $1/2(7 - 4) = 1.5$

a) Bond energy increases as bond order increases:  $\text{C}_2^+ < \text{C}_2 < \text{C}_2^-$

b) Bond length decreases as bond energy increases, so the order of increasing bond length will be opposite that of increasing bond energy. Increasing bond length:  $\text{C}_2^- < \text{C}_2 < \text{C}_2^+$

11.38

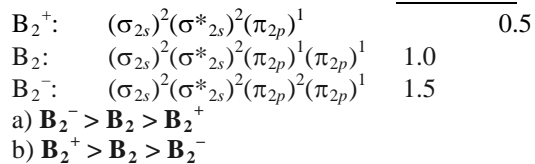
Bond order

11.39

			<u>Ideal</u>	<u>Deviations</u>
a) $\text{BrO}_3^-$	$\text{AX}_3\text{E}$	<b>trigonal pyramidal</b> $sp^3$ hybrid AO	<b>109.5°</b>	<b>&lt;109.5°</b>
b) $\text{AsCl}_4^-$	$\text{AX}_4\text{E}$	<b>seesaw</b> $sp^3d$ hybrid AO	<b>120°, 90°</b>	<b>&lt;120°, &lt;90°</b>
c) $\text{SeO}_4^{2-}$	$\text{AX}_4$	<b>tetrahedral</b> $sp^3$ hybrid AO	<b>109.5°</b>	<b>none</b>
d) $\text{BiF}_5^{2-}$	$\text{AX}_5\text{E}$	<b>square pyramidal</b> $sp^3d^2$ hybrid AO	<b>90°</b>	<b>&lt;90°</b>
e) $\text{SbF}_4^+$	$\text{AX}_4$	<b>tetrahedral</b> $sp^3$ hybrid AO	<b>109.5°</b>	<b>none</b>
f) $\text{AlF}_6^{3-}$	$\text{AX}_6$	<b>octahedral</b> $sp^3d^2$ hybrid AO	<b>90°</b>	<b>none</b>
g) $\text{IF}_4^+$	$\text{AX}_4\text{E}$	<b>seesaw</b> $sp^3d$ hybrid AO	<b>120°, 90°</b>	<b>&lt;120°, &lt;90°</b>

Lewis structures:

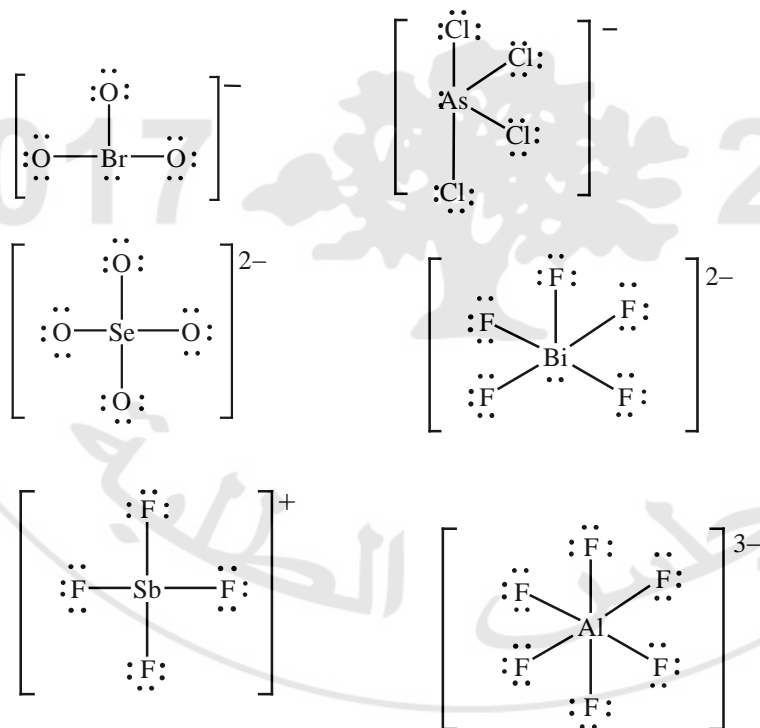

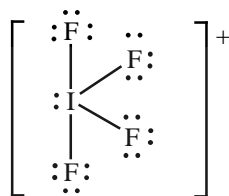

11.40 a) There are **9  $\sigma$**  and **2  $\pi$**  bonds. Each of the six C–H bonds are sigma bonds. The C–C bond contains a sigma bond. The double bonds between the carbons consist of a pi bond in addition to the sigma bond.

11.41 Plan: To determine hybridization, count the number of electron groups around each of the C, O, and N atoms. Hybridize that number of orbitals. Single, double, and triple bonds all count as one electron group. An unshared pair (lone pair) of electrons or one unshared electron also counts as one electron group. A single bond is a sigma bond which is the result of two orbitals overlapping end to end; a double bond consists of one sigma bond and one pi bond; and a triple bond consists of one sigma bond and two pi bonds.

Solution:

a) Each of the six C atoms in the ring has three electron groups (two single bonds and a double bond) and has  $sp^2$  hybridization; all of the other C atoms have four electron groups (four single bonds) and have  $sp^3$  hybridization; all of the O atoms have four electron groups (two single bonds and two lone pairs) and have  $sp^3$  hybridization; the N atom has four electron groups (three single bonds and a lone pair) and has  $sp^3$  hybridization.

b) Each of the single bonds is a sigma bond; each of the double bonds has one sigma bond for a total of **26 sigma bonds**.

c) The ring has three double bonds each of which is composed of one sigma bond and one pi bond; so there are three pi bonds each with two electrons for a total of **six pi electrons**.

11.42

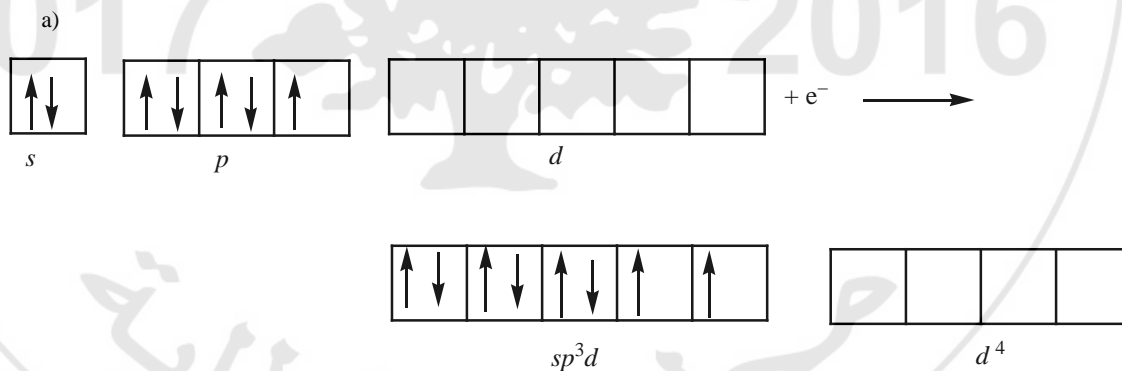



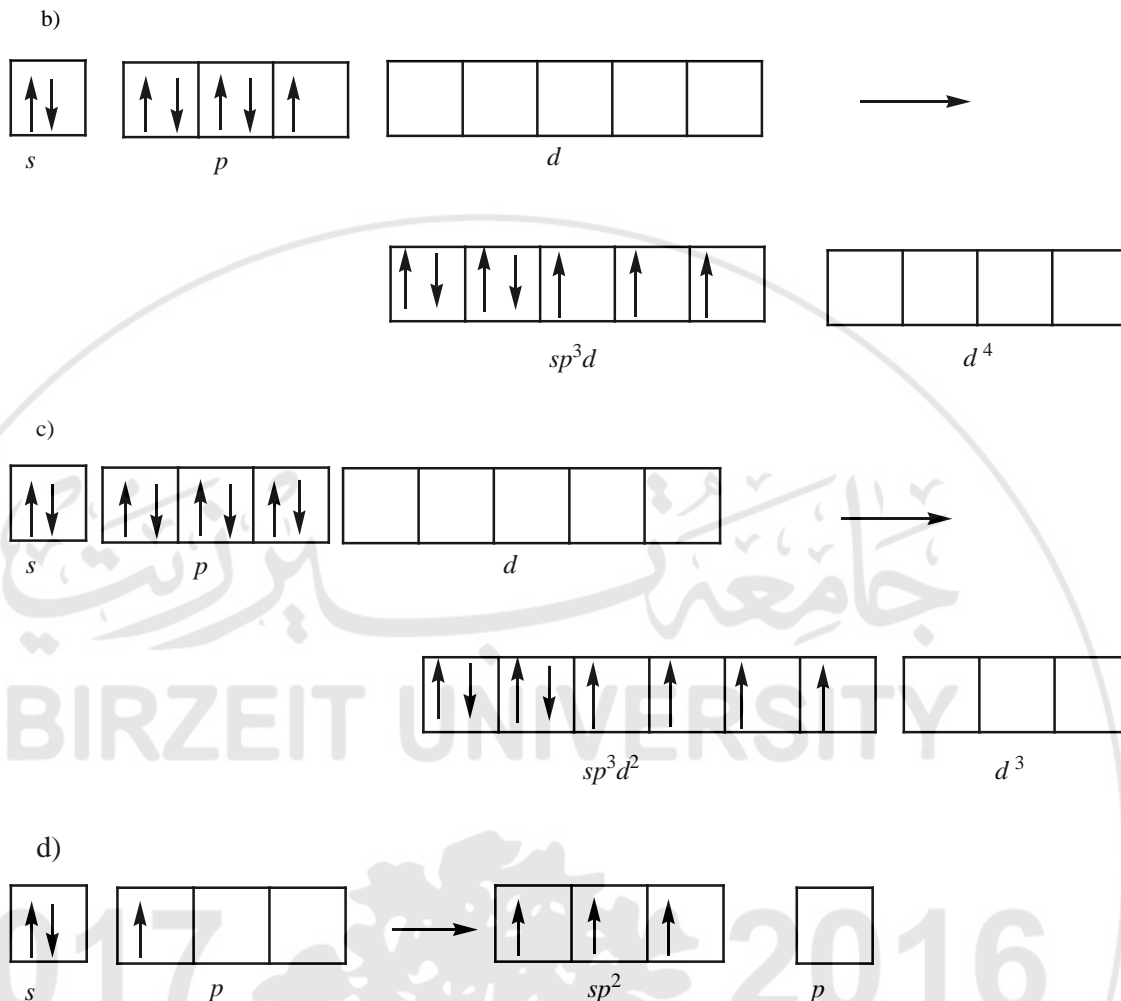

11.43 **Plan:** To determine hybridization, count the number of electron groups around each C and N atom. Hybridize that number of orbitals. Single, double, and triple bonds all count as one electron group. An unshared pair (lone pair) of electrons or one unshared electron also counts as one electron group. A single bond is a sigma bond which is the result of two orbitals overlapping end to end; a double bond consists of one sigma bond and one pi bond; and a triple bond consists of one sigma bond and two pi bonds.

**Solution:**

a) Every single bond is a sigma bond. There is one sigma bond in each double bond as well. There are **17  $\sigma$**  bonds in isoniazid. Every atom-to-atom connection contains a  $\sigma$  bond.

b) All carbons have three surrounding electron groups (two single and one double bond), so their hybridization is  $sp^2$ . The ring N also has three surrounding electron groups (one single bond, one double bond, and one lone pair), so its hybridization is also  $sp^2$ . The other two N atoms have four surrounding electron groups (three single bonds and one lone pair) and are  $sp^3$  hybridized.

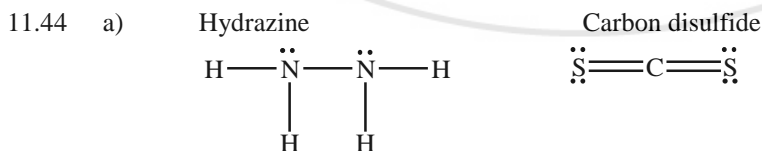

b) The electron-group arrangement around each nitrogen changes from tetrahedral to trigonal planar. The molecular shape changes from trigonal pyramidal to bent and the hybridization changes from  $sp^3$  to  $sp^2$ .

c) The electron-group arrangement and molecular shape around carbon change from linear to trigonal planar. The hybridization changes from  $sp$  to  $sp^2$ .

11.45 Plan: To determine the hybridization in each species, count the number of electron groups around the underlined atom. Hybridize that number of orbitals. Single, double, and triple bonds all count as one electron group. An unshared pair (lone pair) of electrons or one unshared electron also counts as one electron group.

Solution:

a) B changes from  $sp^2 \rightarrow sp^3$ . Boron in  $\text{BF}_3$  has three electron groups with  $sp^2$  hybridization. In  $\text{BF}_4^-$ , four electron groups surround B with  $sp^3$  hybridization.

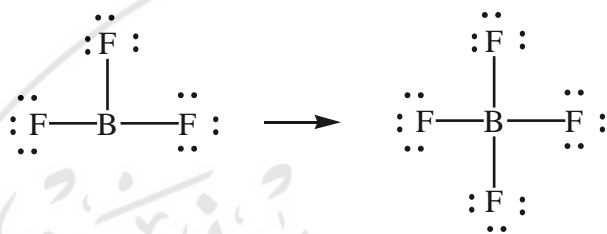

b) P changes from  $sp^3 \rightarrow sp^3d$ . Phosphorus in  $\text{PCl}_3$  is surrounded by four electron groups (three bonds to Cl and one lone pair) for  $sp^3$  hybridization. In  $\text{PCl}_5$ , phosphorus is surrounded by five electron groups for  $sp^3d$  hybridization.

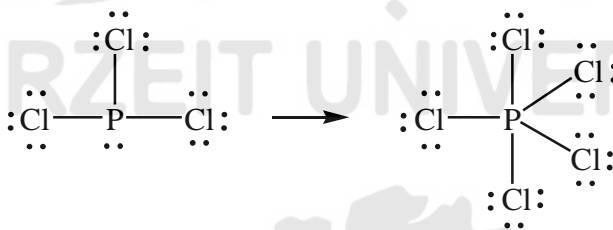

c) C changes from  $sp \rightarrow sp^2$ . Two electron groups surround C in  $\text{C}_2\text{H}_2$  and three electron groups surround C in  $\text{C}_2\text{H}_4$ .



d) Si changes from  $sp^3 \rightarrow sp^3d^2$ . Four electron groups surround Si in  $\text{SiF}_4$  and six electron groups surround Si in  $\text{SiF}_6^{2-}$ .

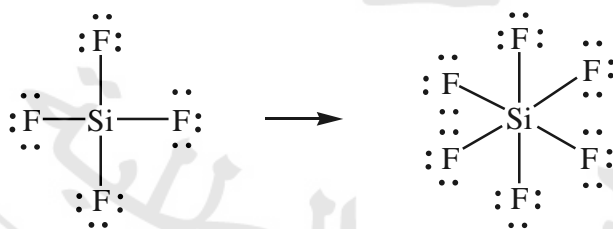

e) **No change**, S in  $\text{SO}_2$  is surrounded by three electron groups (one single bond, one double bond, and one lone pair) and in  $\text{SO}_3$  is surrounded by three electron groups (two single bonds and one double bond); both have  $sp^2$  hybridization.

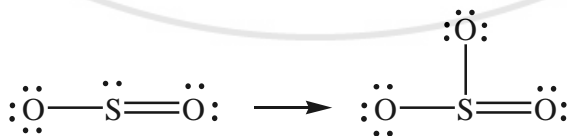

- 11.46 **Plan:** To determine the molecular shape and hybridization, count the number of electron groups around the P, N, and C atoms. Hybridize that number of orbitals. Single, double, and triple bonds all count as one electron group. An unshared pair (lone pair) of electrons or one unshared electron also counts as one electron group.

**Solution:**

P (3 single bonds and 1 double bond)	AX <sub>4</sub>	<b>tetrahedral</b>	<i>sp</i> <sup>3</sup>
N (3 single bonds and 1 lone pair)	AX <sub>3</sub> E	<b>trigonal pyramidal</b>	<i>sp</i> <sup>3</sup>
C <sub>1</sub> and C <sub>2</sub> (4 single bonds)	AX <sub>4</sub>	<b>tetrahedral</b>	
<i>sp</i> <sup>3</sup>			
C <sub>3</sub> (2 single bonds and 1 double bond)	AX <sub>3</sub>	<b>trigonal planar</b>	<i>sp</i> <sup>2</sup>

- 11.47 a) The representation with two S=O double bonds:

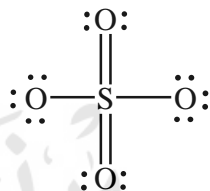

$$FC_S = 6 - [0 + 1/2(12)] = 0 \quad FC_{O(\text{single bond})} = 6 - [6 + 1/2(2)] = -1$$

$$FC_{O(\text{double bond})} = 6 - [4 + 1/2(4)] = 0$$

The representation with four S-O single bonds:

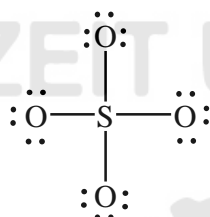

$$FC_S = 6 - [0 + 1/2(8)] = +2 \quad FC_O = 6 - [6 + 1/2(2)] = -1$$

The representation with **two S=O double bonds** is better since it minimizes formal charges. For sulfur, the formal charge in the single bond representation is +2 while in the double bond representation it decreases to zero. The formal charge for the oxygen atoms double bonded to the sulfur increases from -1 in the representation with four single bonds to 0 in the representation with two double bonds. The oxygens that are single bonded in both cases have the same formal charge in both representations, -1.

b) In both representations the sulfate ion is **tetrahedral** because 4 electron groups surround S in both cases. The double bonded representation would show some deviation from the ideal angle of 109.5° due to the double bonds. The single bond hybridization is *sp*<sup>3</sup>.

c) Since sulfur's valence *p*-orbitals are used in the sigma bonds, the  $\pi$  bonds are formed from the valence **3d orbitals in sulfur overlapping with 2p orbitals in oxygen.**

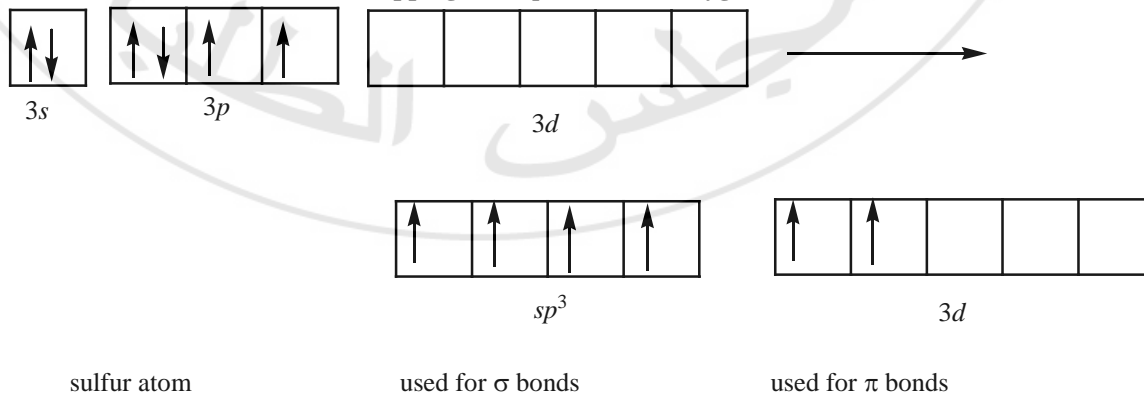

d)

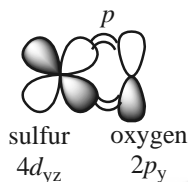

11.48 a) **1:  $sp^3$  2:  $sp^2$  3:  $sp^3$  4:  $sp^3$  5:  $sp^2$  6:  $sp^2$**

b) **28**

c) **a:  $< 109.5^\circ$  b:  $120^\circ$  c:  $120^\circ$**

11.49  $O_2$   $(\sigma_{2s})^2(\sigma_{2s}^*)^2(\sigma_{2p})^2(\pi_{2p})^2(\pi_{2p})^2(\pi_{2p}^*)^1(\pi_{2p}^*)^1$  bond order = 2.0 paramagnetic  
(2 unpaired)

$O_2^+$   $(\sigma_{2s})^2(\sigma_{2s}^*)^2(\sigma_{2p})^2(\pi_{2p})^2(\pi_{2p})^2(\pi_{2p}^*)^1$  bond order = 2.5 paramagnetic  
(1 unpaired)

$O_2^-$   $(\sigma_{2s})^2(\sigma_{2s}^*)^2(\sigma_{2p})^2(\pi_{2p})^2(\pi_{2p})^2(\pi_{2p}^*)^2(\pi_{2p}^*)^1$  bond order = 1.5 paramagnetic  
(1 unpaired)

$O_2^{2-}$   $(\sigma_{2s})^2(\sigma_{2s}^*)^2(\sigma_{2p})^2(\pi_{2p})^2(\pi_{2p})^2(\pi_{2p}^*)^2(\pi_{2p}^*)^2$  bond order = 1.0 diamagnetic  
(0 unpaired)

Bond length:  $O_2^+ < O_2 < O_2^- < O_2^{2-}$

11.50 a) **Yes**, each one is  $sp^2$  hybridized.

b) **Yes**, each one is  $sp^3$  hybridized.

c) C–O bonds: **6  $\sigma$  bonds, 1  $\pi$  bond.**

d) No, the C=O lone pair electrons are in  $sp^2$  hybrid orbitals, while the other oxygen lone pairs occupy  $sp^3$  hybrid orbitals.

11.51 **Plan:** To determine the hybridization, count the number of electron groups around the atoms. Hybridize that number of orbitals. Single, double, and triple bonds all count as one electron group. An unshared pair (lone pair) of electrons or one unshared electron also counts as one electron group.

**Solution:**

a) **B and D** show hybrid orbitals that are present in the molecule. B shows  $sp^3$  hybrid orbitals, used by atoms that have four groups of electrons. In the molecule, the C atom in the  $CH_3$  group, the S atom, and the O atom all have four groups of electrons and would have  $sp^3$  hybrid orbitals. D shows  $sp^2$  hybrid orbitals, used by atoms that have three groups of electrons. In the molecule, the C bonded to the nitrogen atom, the C atoms involved in the C=C bond, and the nitrogen atom all have three groups of electrons and would have  $sp^2$  hybrid orbitals.

b) The C atoms in the  $C\equiv C$  bond have only two electron groups and would have  **$sp$  hybrid orbitals**. These orbitals are not shown in the picture.

c) There are **two sets of  $sp$  hybrid orbitals**, **four sets of  $sp^2$  hybrid orbitals**, and **three sets of  $sp^3$  hybrid orbitals** in the molecule.

11.52

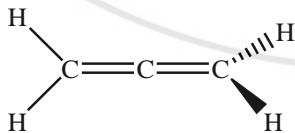

The central C is  $sp$  hybridized, and the other two C atoms are  $sp^2$ .

11.53 Draw the Lewis structures.

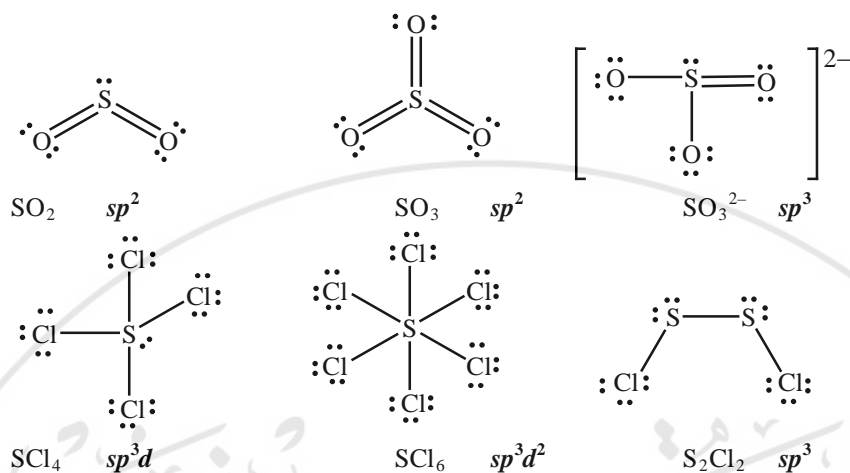

11.54 a)

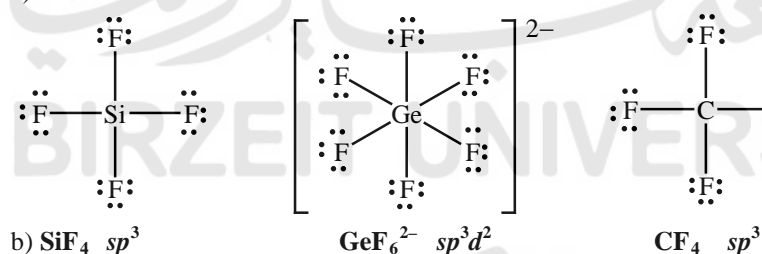

c) Carbon has no  $d$ -orbitals available to form  $sp^3d^2$  hybrids.

11.55 a) N has  $sp^2$  hybridization, formed from **one 2s and two 2p orbitals**.

b) The lone pair is in a  $sp^2$  hybrid orbital.

c) Hybridization of C in  $\text{CH}_3$  is  $sp^3$ ; C in the ring is  $sp^2$ .

11.56 **Plan:** To determine hybridization, count the number of electron groups around each C and O atom. Hybridize that number of orbitals. Single, double, and triple bonds all count as one electron group. An unshared pair (lone pair) of electrons or one unshared electron also counts as one electron group. A single bond is a sigma bond which is the result of two orbitals overlapping end to end; a double bond consists of one sigma bond and one pi bond; and a triple bond consists of one sigma bond and two pi bonds.

**Solution:**

a) The six carbons in the ring each have three surrounding electron groups (two single bonds and one double bond) with  $sp^2$  hybrid orbitals. The two carbons participating in the  $\text{C}=\text{O}$  bond are also  $sp^2$  hybridized. The single carbon in the  $-\text{CH}_3$  group has four electron groups (four single bonds) and is  $sp^3$  hybridized. The two central oxygen atoms, one in a  $\text{C}-\text{O}-\text{H}$  configuration and the other in a  $\text{C}-\text{O}-\text{C}$  configuration, each have four surrounding electron groups (two single bonds and two lone pairs) and are  $sp^3$  hybridized. The O atoms in the two  $\text{C}=\text{O}$  bonds have three electron groups (one double bond and two lone pairs) and are  $sp^2$  hybridized.

Summary: C in  $-\text{CH}_3$ :  $sp^3$ , all other C atoms (8 total):  $sp^2$ , O in  $\text{C}=\text{O}$  (2 total):  $sp^2$ , O in the  $\text{C}-\text{O}$  bonds (2 total):  $sp^3$ .

b) The **two**  $\text{C}=\text{O}$  bonds are localized; the double bonds on the ring are delocalized as in benzene.

c) Each carbon with three surrounding groups has  $sp^2$  hybridization and trigonal planar shape; therefore, **eight** carbons have this shape. Only **one** carbon in the  $\text{CH}_3$  group has four surrounding groups with  $sp^3$  hybridization and tetrahedral shape.



# CHAPTER 12 INTERMOLECULAR FORCES: LIQUIDS, SOLIDS, AND PHASE CHANGES

---

## END-OF-CHAPTER PROBLEMS

- 12.1 The energy of attraction is a *potential* energy and denoted  $E_p$ . The energy of motion is *kinetic* energy and denoted  $E_k$ . The relative strength of  $E_p$  vs.  $E_k$  determines the phase of the substance. In the gas phase,  $E_p \ll E_k$  because gas particles experience little attraction for one another and the particles are moving very fast. In the solid phase,  $E_p \gg E_k$  because the particles are very close together and are only vibrating in place. Two properties that differ between a gas and a solid are the volume and density. The volume of a gas expands to fill the container it is in while the volume of a solid is constant no matter what container holds the solid. Density of a gas is much less than the density of a solid. The density of a gas also varies significantly with temperature and pressure changes. The density of a solid is only slightly altered by changes in temperature and pressure. Compressibility and ability to flow are other properties that differ between gases and solids.
- 12.2 a) Gases are more easily compressed than liquids because the distance between particles is much greater in a gas than in a liquid. Liquids have very little free space between particles and thus can be compressed (crowded together) only very slightly.  
b) Liquids have a greater ability to flow because the interparticle forces are weaker in the liquid phase than in the solid phase. The stronger interparticle forces in the solid phase fix the particles in place. Liquid particles have enough kinetic energy to move around.
- 12.3 a) **intermolecular**      b) **intermolecular**      c) **intermolecular**      d) **intramolecular**
- 12.4 a) Heat of fusion refers to the change between the solid and the liquid states and heat of vaporization refers to the change between liquid and gas states. In the change from solid to liquid, the kinetic energy of the molecules must increase only enough to partially offset the intermolecular attractions between molecules. In the change from liquid to gas, the kinetic energy of the molecules must increase enough to overcome the intermolecular forces. The energy to overcome the intermolecular forces for the molecules to move freely in the gaseous state is much greater than the amount of energy needed to allow the molecules to move more easily past each other but still stay very close together.  
b) The net force holding molecules together in the solid state is greater than that in the liquid state. Thus, to change solid molecules to gaseous molecules in sublimation requires more energy than to change liquid molecules to gaseous molecules in vaporization.  
c) At a given temperature and pressure, the magnitude of  $\Delta H_{\text{vap}}$  is the same as the magnitude of  $\Delta H_{\text{cond}}$ . The only difference is in the sign:  $\Delta H_{\text{vap}} = -\Delta H_{\text{cond}}$ .
- 12.5 a) **Condensation**      The water vapor in the air condenses to liquid when the temperature drops during the night.  
b) **Fusion** (melting)      Solid ice melts to liquid water.  
c) **Evaporation**      Liquid water on clothes evaporates to water vapor.
- 12.6 a) **deposition**      b) **sublimation**      c) **crystallization** (freezing)
- 12.7 The propane gas molecules slow down as the gas is compressed. Therefore, much of the **kinetic energy** lost by the propane molecules is released to the surroundings upon liquefaction.
- 12.8 **Sublimation and deposition**
- 12.9 The gaseous  $\text{PCl}_3$  molecules are moving faster and are farther apart than the liquid molecules. As they condense, the kinetic energy of the molecules is changed into potential energy stored in the dipole-dipole interactions between the molecules.

- 12.10 The two processes are the formation of solid from liquid and the formation of liquid from solid (at the macroscopic level). At the molecular level, the two processes are the removal of kinetic energy from the liquid molecules as they solidify and the overcoming of the dispersion forces between the molecules as they turn to liquid.
- 12.11 In closed containers, two processes, evaporation and condensation, occur simultaneously. Initially there are few molecules in the vapor phase, so more liquid molecules evaporate than gas molecules condense. Thus, the number of molecules in the gas phase increases, causing the vapor pressure of hexane to increase. Eventually, the number of molecules in the gas phase reaches a maximum where the number of liquid molecules evaporating equals the number of gas molecules condensing. In other words, the evaporation rate equals the condensation rate. At this point, there is no further change in the vapor pressure.
- 12.12 **Point 1 is depicted by C.** This is the equilibrium between melting and freezing.  
**Point 2 is depicted by A.** This is the equilibrium between vaporization and condensation.  
**Point 3 is depicted by D.** This is the equilibrium between sublimation and deposition.
- 12.13 **No,** at 1.1 atm, water boils at a temperature above 100°C, since it is more difficult for gas molecules to escape the liquid when the applied pressure is greater.
- 12.14 If the solid is more dense than the liquid, the solid-liquid line slopes to the right; if less dense, to the left.
- 12.15 Plan: The total heat required is the sum of three processes: warming the ice to 0.00°C, the melting point; melting the ice to liquid water; warming the water to 0.500°C. The equation  $q = c \times \text{mass} \times \Delta T$  is used to calculate the heat involved in changing the temperature of the ice and of the water; the heat of fusion is used to calculate the heat involved in the phase change of ice to water.  
Solution:  
 1) Warming the ice from -6.00°C to 0.00°C:  

$$q_1 = c \times \text{mass} \times \Delta T = (2.09 \text{ J/g}^\circ\text{C})(22.00 \text{ g})[0.0 - (-6.00)]^\circ\text{C} = 275.88 \text{ J}$$
 2) Phase change of ice at 0.00°C to water at 0.00°C:  

$$q_2 = n(\Delta H_{\text{fus}}^\circ) = (22.0 \text{ g})\left(\frac{1 \text{ mol}}{18.02 \text{ g}}\right)\left(\frac{6.02 \text{ kJ}}{\text{mol}}\right)\left(\frac{10^3 \text{ J}}{1 \text{ kJ}}\right) = 7349.6115 \text{ J}$$
 3) Warming the liquid from 0.00°C to 0.500°C:  

$$q_3 = c \times \text{mass} \times \Delta T = (4.21 \text{ J/g}^\circ\text{C})(22.00 \text{ g})[0.500 - (0.0)]^\circ\text{C} = 46.31 \text{ J}$$
 The three heats are positive because each process takes heat from the surroundings (endothermic). The phase change requires much more energy than the two temperature change processes. The total heat is  

$$q_1 + q_2 + q_3 = (275.88 \text{ J} + 7349.6115 \text{ J} + 46.31 \text{ J}) = 7671.8015 = \mathbf{7.67 \times 10^3 \text{ J}}$$
- 12.16  $0.333 \text{ mol} \times 46.07 \text{ g/mol} = 15.34131 \text{ g ethanol}$   
 Cooling vapor to boiling point:  

$$q_1 = c \times \text{mass} \times \Delta T = (1.43 \text{ J/g}^\circ\text{C})(15.34131 \text{ g})(78.5 - 300)^\circ\text{C} = -4859.28 \text{ J}$$
 Condensing vapor: (note  $\Delta H_{\text{cond}} = -\Delta H_{\text{vap}}$ )  

$$q_2 = n(\Delta H_{\text{cond}}^\circ) = (0.333 \text{ mol})(-38.6 \text{ kJ/mol})(10^3 \text{ J/kJ}) = -12,853.8 \text{ J}$$
 Cooling liquid to 25.0°C:  

$$q_3 = c \times \text{mass} \times \Delta T = (2.45 \text{ J/g}^\circ\text{C})(15.34131 \text{ g})(25.0 - 78.5)^\circ\text{C} = -2010.86 \text{ J}$$

$$q_{\text{total}} = q_1 + q_2 + q_3 = (-4859.28 \text{ J}) + (-12,853.8 \text{ J}) + (-2010.86 \text{ J}) = -19,723.94 = \mathbf{-1.97 \times 10^4 \text{ J}}$$
- 12.17 Plan: The Clausius-Clapeyron equation gives the relationship between vapor pressure and temperature. We are given  $\Delta H_{\text{vap}}^\circ$ ,  $P_1$ ,  $T_1$ , and  $T_2$ ; these values are substituted into the equation to find the  $P_2$ , the vapor pressure.  
Solution:  

$$P_1 = 1.00 \text{ atm} \quad T_1 = 122^\circ\text{C} + 273 = 395 \text{ K}$$

$$P_2 = ? \quad T_2 = 113^\circ\text{C} + 273 = 386 \text{ K} \quad \Delta H_{\text{vap}}^\circ = 35.5 \text{ kJ/mol}$$



$$\ln \frac{P_2}{P_1} = \frac{-\Delta H_{\text{vap}}^{\circ}}{R} \left( \frac{1}{T_2} - \frac{1}{T_1} \right)$$

$$\ln \frac{P_2}{1.00 \text{ atm}} = \frac{-35.5 \frac{\text{kJ}}{\text{mol}}}{8.314 \text{ J/mol}\cdot\text{K}} \left( \frac{1}{386 \text{ K}} - \frac{1}{395 \text{ K}} \right) \left( \frac{10^3 \text{ J}}{1 \text{ kJ}} \right) = -0.2520440$$

$$\frac{P_2}{1.00 \text{ atm}} = 0.7772105$$

$$P_2 = (0.7772105)(1.00 \text{ atm}) = 0.7772105 = \mathbf{0.777 \text{ atm}}$$

- 12.18 **Plan:** The Clausius-Clapeyron equation gives the relationship between vapor pressure and temperature. We are given  $P_1$ ,  $P_2$ ,  $T_1$ , and  $T_2$ ; these values are substituted into the equation to find  $\Delta H_{\text{vap}}^{\circ}$ . The pressure in torr must be converted to atm.

**Solution:**

$$P_1 = (621 \text{ torr}) \left( \frac{1 \text{ atm}}{760 \text{ torr}} \right) = 0.817105 \text{ atm} \quad T_1 = 85.2^{\circ}\text{C} + 273.2 = 358.4 \text{ K}$$

$$P_2 = 1 \text{ atm} \quad T_2 = 95.6^{\circ}\text{C} + 273.2 = 368.8 \text{ K} \quad \Delta H_{\text{vap}}^{\circ} = ?$$

$$\ln \frac{P_2}{P_1} = \frac{-\Delta H_{\text{vap}}^{\circ}}{R} \left( \frac{1}{T_2} - \frac{1}{T_1} \right)$$

$$\ln \frac{1 \text{ atm}}{0.817105 \text{ atm}} = \frac{-\Delta H_{\text{vap}}^{\circ}}{8.314 \text{ J/mol}\cdot\text{K}} \left( \frac{1}{368.8 \text{ K}} - \frac{1}{358.4 \text{ K}} \right)$$

$$0.2019877 = -\Delta H_{\text{vap}}^{\circ} (-9.463775 \times 10^{-6}) \text{ J/mol}$$

$$\Delta H_{\text{vap}}^{\circ} = 21,343.248 = \mathbf{2 \times 10^4 \text{ J/mol}}$$

(The significant figures in the answer are limited by the 1 atm in the problem.)

12.19

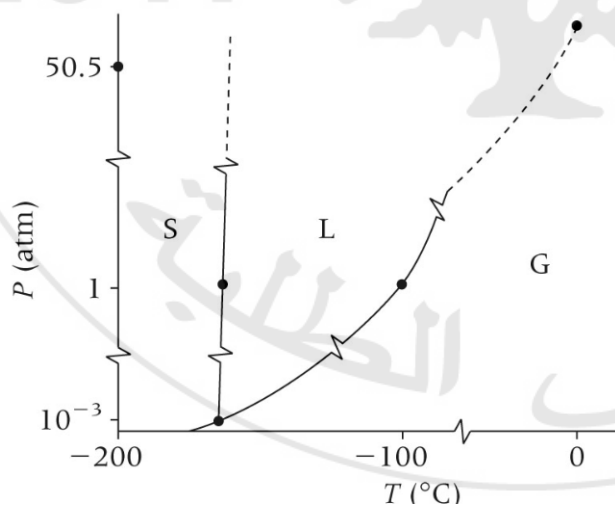

The pressure scale is distorted to represent the large range in pressures given in the problem, so the liquid-solid curve looks different from the one shown in the text. The important features of the graph include the distinction between the gas, liquid, and solid states, and the melting point  $T$ , which is located directly above the critical  $T$ . Solid ethylene is **more dense** than liquid ethylene since the solid-liquid line slopes to the right with increasing pressure.

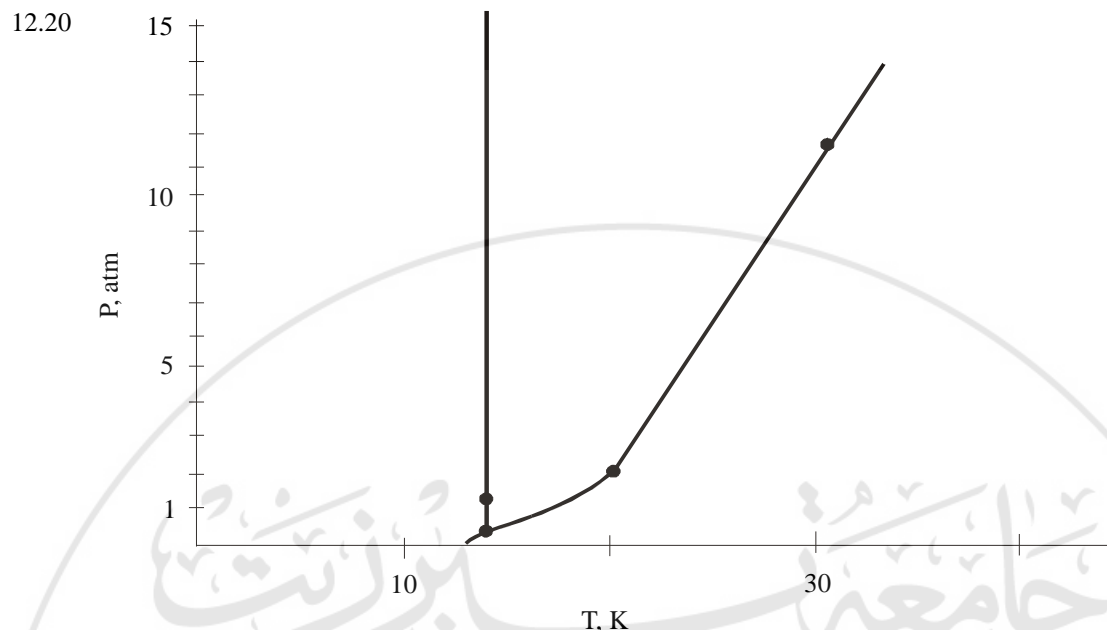

Hydrogen does not sublime at 0.05 atm, since 0.05 atm is below the triple point pressure.

- 12.21 **Plan:** The Clausius-Clapeyron equation gives the relationship between vapor pressure and temperature. We are given  $\Delta H_{\text{vap}}^{\circ}$ ,  $P_1$ ,  $T_1$ , and  $T_2$ ; these values are substituted into the equation to find  $P_2$ . Convert the temperatures from  $^{\circ}\text{C}$  to K and  $\Delta H_{\text{vap}}^{\circ}$  from kJ/mol to J/mol to allow cancellation with the units in  $R$ .

**Solution:**

$$P_1 = 2.3 \text{ atm} \quad T_1 = 25.0^{\circ}\text{C} + 273 = 298 \text{ K}$$

$$P_2 = ? \quad T_2 = 135^{\circ}\text{C} + 273 = 408 \text{ K} \quad \Delta H_{\text{vap}}^{\circ} = 24.3 \text{ kJ/mol}$$

$$\ln \frac{P_2}{P_1} = \frac{-\Delta H_{\text{vap}}^{\circ}}{R} \left( \frac{1}{T_2} - \frac{1}{T_1} \right)$$

$$\ln \frac{P_2}{2.3 \text{ atm}} = \frac{-24.3 \frac{\text{kJ}}{\text{mol}}}{8.314 \text{ J/mol}\cdot\text{K}} \left( \frac{1}{408 \text{ K}} - \frac{1}{298 \text{ K}} \right) \left( \frac{10^3 \text{ J}}{1 \text{ kJ}} \right)$$

$$\ln \frac{P_2}{2.3 \text{ atm}} = 2.644311$$

$$\frac{P_2}{2.3 \text{ atm}} = 14.07374$$

$$P_2 = (14.07374)(2.3 \text{ atm}) = 32.3696 = \mathbf{32 \text{ atm}}$$

- 12.22 a) At  $20^{\circ}\text{C}$  and  $40^{\circ}\text{C}$ , no liquid exists, only gas. At  $-40^{\circ}\text{C}$ , liquid exists. At  $-120^{\circ}\text{C}$ , no liquid exists, only solid.  
 b) **No**, at any pressure below the triple point pressure, the  $\text{CO}_2(s)$  will sublime.  
 c) **No**  
 d) **No**
- 12.23 Intermolecular forces involve interactions of lower (partial) charges at relatively larger distances than in covalent bonds.
- 12.24 Even though molecules are neutral, many of them are polar. These polar molecules will orient themselves so that their partial charges will result in dipole-dipole interactions. The partially positive pole of one molecule attracts the partially negative pole of another.

- 12.25 a) Scene A: dipole-dipole forces; Scene B: dipole-dipole forces; Scene C: ion-dipole forces; Scene D: hydrogen bonds  
b) dipole-dipole forces < hydrogen bonds < ion-dipole
- 12.26 To form hydrogen bonds, the atom bonded to hydrogen must have two characteristics: small size and high electronegativity (so that the atom has a very high electron density). With this high electron density, the attraction for a hydrogen on another molecule is very strong. Selenium is much larger than oxygen (atomic radius of 119 pm vs. 73 pm) and less electronegative than oxygen (2.4 for Se and 3.5 for O) resulting in an electron density on Se in H<sub>2</sub>Se that is too small to form hydrogen bonds.
- 12.27 All particles (atoms and molecules) exhibit dispersion forces, but these are the weakest of intermolecular forces. The dipole-dipole forces in polar molecules dominate the dispersion forces.
- 12.28 Polarity refers to a permanent imbalance in the distribution of electrons in the molecule. Polarizability refers to the ability of the electron distribution in a molecule to change temporarily. The polarity affects dipole-dipole interactions, while the polarizability affects dispersion forces.
- 12.29 If the electron distribution in one molecule is not symmetrical (permanent or temporary), that can induce a temporary dipole in an adjacent molecule by causing the electrons in that molecule to shift for some (often short) time.
- 12.30 Plan: Dispersion forces are the only forces between nonpolar substances; dipole-dipole forces exist between polar substances. Hydrogen bonds only occur in substances in which hydrogen is directly bonded to either oxygen, nitrogen, or fluorine.  
Solution:  
a) **Hydrogen bonding** will be the strongest force between methanol molecules since they contain O–H bonds. Dipole-dipole and dispersion forces also exist.  
b) **Dispersion forces** are the only forces between nonpolar carbon tetrachloride molecules and, thus, are the strongest forces.  
c) **Dispersion forces** are the only forces between nonpolar chlorine molecules and, thus, are the strongest forces.
- 12.31 a) **Hydrogen bonding**   b) **Dipole-dipole**   c) **Ionic bonds**
- 12.32 Plan: Dispersion forces are the only forces between nonpolar substances; dipole-dipole forces exist between polar substances. Hydrogen bonds only occur in substances in which hydrogen is directly bonded to either oxygen, nitrogen, or fluorine.  
Solution:  
a) **Dipole-dipole** interactions will be the strongest forces between methyl chloride molecules because the C–Cl bond has a dipole moment.  
b) **Dispersion** forces dominate because CH<sub>3</sub>CH<sub>3</sub> (ethane) is a symmetrical nonpolar molecule.  
c) **Hydrogen bonding** dominates because hydrogen is bonded to nitrogen, which is one of the three atoms (N, O, or F) that participate in hydrogen bonding.
- 12.33 a) **Dispersion**   b) **Dipole-dipole**   c) **Hydrogen bonding**
- 12.34 Plan: Hydrogen bonds are formed when a hydrogen atom is bonded to N, O, or F.  
Solution:  
a) The presence of an OH group leads to the formation of hydrogen bonds in CH<sub>3</sub>CH(OH)CH<sub>3</sub>. There are no hydrogen bonds in CH<sub>3</sub>SCH<sub>3</sub>.

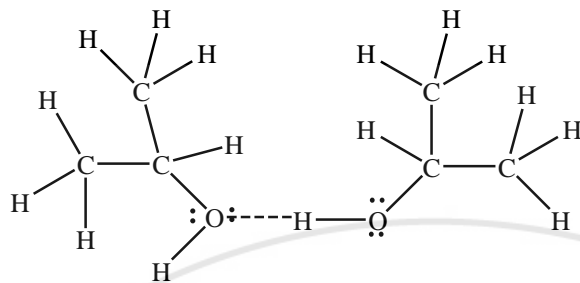

b) The presence of H attached to F in **HF** leads to the formation of hydrogen bonds. There are no hydrogen bonds in **HBr**.

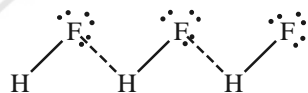

12.35 a) The presence of H directly attached to the N in **(CH<sub>3</sub>)<sub>2</sub>NH** leads to hydrogen bonding. More than one arrangement is possible.

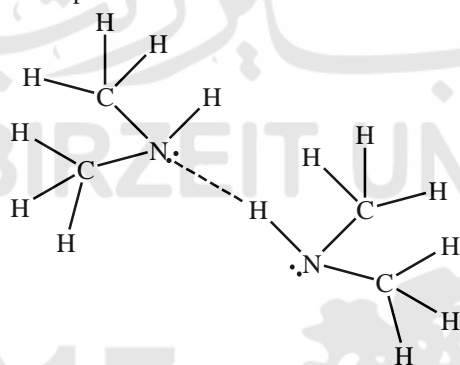

b) Each of the hydrogen atoms directly attached to oxygen atoms in **HOCH<sub>2</sub>CH<sub>2</sub>OH** leads to hydrogen bonding. More than one arrangement is possible. In **FCH<sub>2</sub>CH<sub>2</sub>F**, the H atoms are bonded to C so there is no hydrogen bonding.

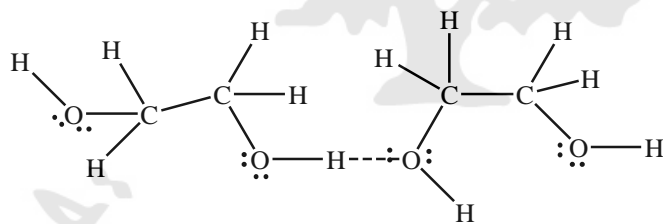

12.36 Plan: Polarizability increases down a group and decreases from left to right because as atomic size increases, polarizability increases.

Solution:

a) **Iodide ion** has greater polarizability than the bromide ion because the iodide ion is larger. The electrons can be polarized over a larger volume in a larger atom or ion.

b) **Ethene (CH<sub>2</sub>=CH<sub>2</sub>)** has greater polarizability than ethane (CH<sub>3</sub>CH<sub>3</sub>) because the electrons involved in  $\pi$  bonds are more easily polarized than electrons involved in  $\sigma$  bonds.

c) **H<sub>2</sub>Se** has greater polarizability than water because the selenium atom is larger than the oxygen atom.

12.37 a) **Ca** b) **CH<sub>3</sub>CH<sub>2</sub>CH<sub>3</sub>** c) **CCl<sub>4</sub>**

In all cases, the larger molecule (i.e., the one with more electrons) has the higher polarizability.

12.38 Plan: Weaker attractive forces result in a higher vapor pressure because the molecules have a smaller energy barrier in order to escape the liquid and go into the gas phase. Decide which of the two substances in each pair has the weaker interparticle force. Dispersion forces are weaker than dipole-dipole forces, which are weaker than hydrogen bonds.

Solution:

- a)  $\text{C}_2\text{H}_6$   $\text{C}_2\text{H}_6$  is a smaller molecule exhibiting weaker dispersion forces than  $\text{C}_4\text{H}_{10}$ .  
b)  $\text{CH}_3\text{CH}_2\text{F}$   $\text{CH}_3\text{CH}_2\text{F}$  has no H–F bonds (F is bonded to C, not to H), so it only exhibits dipole-dipole forces, which are weaker than the hydrogen bonding in  $\text{CH}_3\text{CH}_2\text{OH}$ .  
c)  $\text{PH}_3$   $\text{PH}_3$  has weaker intermolecular forces (dipole-dipole) than  $\text{NH}_3$  (hydrogen bonding).

- 12.39 a)  $\text{HOCH}_2\text{CH}_2\text{OH}$  has a stronger intermolecular force, because there are more –OH groups to hydrogen bond.  
b)  $\text{CH}_3\text{COOH}$  has a stronger intermolecular force, because hydrogen bonding is stronger than dipole-dipole forces.  
c)  $\text{HF}$  has a stronger intermolecular force, because hydrogen bonding is stronger than dipole-dipole forces.

12.40 Plan: The weaker the interparticle forces, the lower the boiling point. Decide which of the two substances in each pair has the weaker interparticle force. Dispersion forces are weaker than dipole-dipole forces, which are weaker than hydrogen bonds, which are weaker than ionic forces.

Solution:

- a)  $\text{HCl}$  would have a lower boiling point than  $\text{LiCl}$  because the dipole-dipole intermolecular forces between hydrogen chloride molecules in the liquid phase are weaker than the significantly stronger ionic forces holding the ions in lithium chloride together.  
b)  $\text{PH}_3$  would have a lower boiling point than  $\text{NH}_3$  because the intermolecular forces in  $\text{PH}_3$  are weaker than those in  $\text{NH}_3$ . Hydrogen bonding exists between  $\text{NH}_3$  molecules but weaker dipole-dipole forces hold  $\text{PH}_3$  molecules together.  
c)  $\text{Xe}$  would have a lower boiling point than iodine. Both are nonpolar with dispersion forces, but the forces between xenon atoms would be weaker than those between iodine molecules since the iodine molecules are more polarizable because of their larger size.

- 12.41 a)  $\text{CH}_3\text{CH}_2\text{OH}$ , hydrogen bonding ( $\text{CH}_3\text{CH}_2\text{OH}$ ) vs. dispersion ( $\text{CH}_3\text{CH}_2\text{CH}_3$ )  
b)  $\text{NO}$ , dipole-dipole ( $\text{NO}$ ) vs. dispersion ( $\text{N}_2$ )  
c)  $\text{H}_2\text{Te}$ , the larger molecule has larger dispersion forces

12.42 Plan: The weaker the intermolecular forces, the lower the boiling point. Decide which of the two substances in each pair has the weaker intermolecular force. Dispersion forces are weaker than dipole-dipole forces, which are weaker than hydrogen bonds, which are weaker than ionic forces.

Solution:

- a)  $\text{C}_4\text{H}_8$ , the cyclic molecule, cyclobutane, has less surface area exposed, so its dispersion forces are weaker than the straight chain molecule,  $\text{C}_4\text{H}_{10}$ .  
b)  $\text{PBr}_3$ , the dipole-dipole forces of phosphorous tribromide are weaker than the ionic forces of sodium bromide.  
c)  $\text{HBr}$ , the dipole-dipole forces of hydrogen bromide are weaker than the hydrogen bonding forces of water.

- 12.43 a)  $\text{CH}_3\text{OH}$ , hydrogen bonding ( $\text{CH}_3\text{OH}$ ) vs. dispersion forces ( $\text{CH}_3\text{CH}_3$ ).  
b)  $\text{FNO}$ , greater polarity in  $\text{FNO}$  vs.  $\text{ClNO}$   
c)

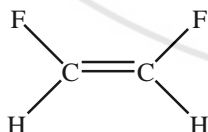

This molecule has dipole-dipole forces since the two C–F bonds do not cancel and the molecule is polar. The other molecule has only dispersion forces since the two C–F bonds do cancel, so that the molecule is nonpolar.

- 12.44 The molecules of motor oil are long chains of  $\text{CH}_2$  units. The high molar mass results in stronger dispersion forces and leads to a high boiling point. In addition, these chains can become tangled in one another and restrict each other's motions and ease of vaporization.
- 12.45 The ethylene glycol molecules have two sites (two  $-\text{OH}$  groups) which can hydrogen bond; the propanol has only one  $-\text{OH}$  group.
- 12.46 The molecules at the surface are attracted to one another and to those molecules in the bulk of the liquid. Since this force is directed downwards and sideways, it tends to "tighten the skin."
- 12.47 The shape of the drop depends upon the competing cohesive forces (attraction of molecules within the drop itself) and adhesive forces (attraction between molecules in the drop and the molecules of the waxed floor). If the cohesive forces are strong and outweigh the adhesive forces, the drop will be as spherical as gravity will allow. If, on the other hand, the adhesive forces are significant, the drop will spread out. Both water (hydrogen bonding) and mercury (metallic bonds) have strong cohesive forces, whereas cohesive forces in oil (dispersion) are relatively weak. Neither water nor mercury will have significant adhesive forces to the nonpolar wax molecules, so these drops will remain nearly spherical. The adhesive forces between the oil and wax can compete with the weak, cohesive forces of the oil (dispersion) and so the oil drop spreads out.
- 12.48 The strength of the intermolecular forces does not change when the liquid is heated, but the molecules have greater kinetic energy and can overcome these forces more easily as they are heated. The molecules have more energy at higher temperatures, so they can break the intermolecular forces and can move more easily past their neighbors; thus, viscosity decreases.
- 12.49 **Plan:** The stronger the intermolecular force, the greater the surface tension. Decide which of the substances has the weakest intermolecular force and which has the strongest. Dispersion forces are weaker than dipole-dipole forces, which are weaker than hydrogen bonds, which are weaker than ionic forces.  
**Solution:**  
 All three molecules exhibit hydrogen bonding (H is bonded to O), but the extent of hydrogen bonding increases with the number of O–H bonds present in each molecule.  $\text{HOCH}_2\text{CH}(\text{OH})\text{CH}_2\text{OH}$  with three O–H groups can form more hydrogen bonds than  $\text{HOCH}_2\text{CH}_2\text{OH}$  with two O–H groups, which in turn can form more hydrogen bonds than  $\text{CH}_3\text{CH}_2\text{CH}_2\text{OH}$  with only one O–H group. The greater the number of hydrogen bonds, the stronger the intermolecular forces, and the higher the surface tension.  
 $\text{CH}_3\text{CH}_2\text{CH}_2\text{OH} < \text{HOCH}_2\text{CH}_2\text{OH} < \text{HOCH}_2\text{CH}(\text{OH})\text{CH}_2\text{OH}$
- 12.50  $\text{CH}_3\text{OH} > \text{H}_2\text{CO} > \text{CH}_3\text{CH}_3$   
 The intermolecular forces would decrease as shown (hydrogen bonding > dipole-dipole > dispersion), as would the surface tension.

- 12.51 a) Calculate the energies involved using the heats of fusion.

$$q_{\text{Hg}} = n(\Delta H_{\text{fus}}^\circ) = (12.0 \text{ g Hg}) \left( \frac{1 \text{ mol Hg}}{200.6 \text{ g Hg}} \right) \left( \frac{23.4 \text{ kJ}}{1 \text{ mol Hg}} \right) = 1.3998 = 1.40 \text{ kJ}$$

$$q_{\text{methane}} = n(\Delta H_{\text{fus}}^\circ) = (12.0 \text{ g CH}_4) \left( \frac{1 \text{ mol CH}_4}{16.04 \text{ g CH}_4} \right) \left( \frac{0.94 \text{ kJ}}{1 \text{ mol CH}_4} \right) = 0.70324 = 0.70 \text{ kJ}$$

**Mercury** takes more energy.

- b) Calculate the energies involved using the heats of vaporization.

$$q_{\text{Hg}} = n(\Delta H_{\text{vap}}^\circ) = (12.0 \text{ g Hg}) \left( \frac{1 \text{ mol Hg}}{200.6 \text{ g Hg}} \right) \left( \frac{59 \text{ kJ}}{1 \text{ mol Hg}} \right) = 3.5294 = 3.5 \text{ kJ}$$

$$q_{\text{methane}} = n(\Delta H_{\text{vap}}^\circ) = (12.0 \text{ g CH}_4) \left( \frac{1 \text{ mol CH}_4}{16.04 \text{ g CH}_4} \right) \left( \frac{8.9 \text{ kJ}}{1 \text{ mol CH}_4} \right) = 6.65835 = 6.6 \text{ kJ}$$

**Methane** takes more energy.

- c) Mercury involves **metallic bonding** and methane involves **dispersion forces**.

- 12.52 The pentanol has stronger intermolecular forces (hydrogen bonds) than the hexane (dispersion forces).
- 12.53 Water is a good solvent for polar and ionic substances and a poor solvent for nonpolar substances. Water is a polar molecule and dissolves polar substances because their intermolecular forces are of similar strength. Water is also able to dissolve ionic compounds and keep ions separated in solution through ion-dipole interactions. Nonpolar substances will not be very soluble in water since their dispersion forces are much weaker than the hydrogen bonds in water. A solute whose intermolecular attraction to a solvent molecule is less than the attraction between two solvent molecules will not dissolve because its attraction cannot replace the attraction between solvent molecules.
- 12.54 A single water molecule can form four hydrogen bonds. The two hydrogen atoms form a hydrogen bond each to oxygen atoms on neighboring water molecules. The two lone pairs on the oxygen atom form hydrogen bonds with hydrogen atoms on neighboring molecules.
- 12.55 The heat capacity of water is quite high, meaning that a large amount of heat is needed to change the temperature of a quantity of water by even a small amount.
- 12.56 Water exhibits strong capillary action, which allows it to be easily absorbed by the plant's roots and transported to the leaves.
- 12.57 In ice, water molecules pack in a very specific, ordered way. When it melts, the molecular order is disrupted and the molecules pack more closely. This makes liquid water (at least below 4°C) denser than ice and allows ice to float.
- 12.58 As the temperature of the ice increases, the water molecules move more vigorously about their fixed positions until at some temperature, the increasing kinetic energy of the water molecules at last overcomes the attractions (hydrogen bonding) between them, allowing the water molecules to move freely through the liquid.
- 12.59 An amorphous solid has little order on the molecular level and has no characteristic crystal shape on the macroscopic level. An example would be rubber. A crystalline solid has a great deal of order on the molecular level and forms regularly shaped forms bounded by flat faces on the macroscopic level. An example would be NaCl.
- 12.60 When the unit cell is repeated infinitely in all directions, the crystal lattice is formed.
- 12.61 The simple, body-centered, and face-centered cubic unit cells contain one, two, and four atoms, respectively. Atoms in the body of a cell are in that cell only; atoms on faces are shared by two cells; atoms at corners are shared by eight cells. All of the cells have eight corner atoms;  $8 \text{ atoms} \times \frac{1}{8} \text{ atom per cell} = 1 \text{ atom}$ . In addition, the body-centered cell has an atom in the center, for a total of two atoms. The face-centered cell has six atoms in the faces;  $6 \text{ atoms} \times \frac{1}{2} \text{ atom per cell} = 3 \text{ atoms}$ , for a total of 4 in the cell (corner + face).
- 12.62 A solid metal is a shiny solid that conducts heat, is malleable, and melts at high temperatures. (Other answers include relatively high boiling point and good conductor of electricity.)
- 12.63
- Potassium is a larger atom than sodium, so its electrons are held more loosely and thus its metallic bond strength is weaker.
  - Be has two valence electrons per atom compared with Li, which has one. The metallic bond strength is stronger for the Be.
  - The boiling point is high due to the large amount of energy needed to separate the metal ions from each other in the electron sea.
- 12.64 When metallic magnesium is deformed, the atoms are displaced and pass over one another while still being tightly held by the attraction of the "sea of electrons." When ionic  $\text{MgF}_2$  is deformed, the ions are displaced so that repulsive forces between neighboring ions of like charge cause shattering of the crystals.

- 12.65 The energy gap is the energy difference between the highest filled energy level (valence band) and the lowest unfilled energy level (conduction band). In conductors and superconductors, the energy gap is zero because the valence band overlaps the conduction band. In semiconductors, the energy gap is small but greater than zero. In insulators, the energy gap is large and thus insulators do not conduct electricity.
- 12.66 Plan: The simple cubic structure unit cell contains one atom since the atoms at the eight corners are shared by eight cells for a total of 8 atoms  $\times$  1/8 atom per cell = 1 atom; the body-centered cell also has an atom in the center, for a total of two atoms; the face-centered cell has six atoms in the faces which are shared by two cells: 6 atoms  $\times$  1/2 atom per cell = 3 atoms plus another atom from the eight corners for a total of four atoms.  
Solution:  
a) Ni is **face-centered cubic** since there are four atoms/unit cell.  
b) Cr is **body-centered cubic** since there are two atoms/unit cell.  
c) Ca is **face-centered cubic** since there are four atoms/unit cell.
- 12.67 a) **one** b) **two** c) **four**
- 12.68 a) There is a change in unit cell from CdO in a sodium chloride structure to CdSe in a zinc blende structure.  
b) **Yes**, the coordination number of Cd does change from six in the CdO unit cell to four in the CdSe unit cell.
- 12.69 a) The unit cell of Fe changes from a face-centered cubic unit cell at 1674 K to a body-centered cubic unit cell below 1181 K.  
b) The face-centered cubic cell has the greater packing efficiency.
- 12.70 Plan: Substances composed of individual atoms are atomic solids; molecular substances composed of covalent molecules form molecular solids; ionic compounds form ionic solids; metal elements form metallic solids; certain substances that form covalent bonds between atoms or molecules form network covalent solids.  
Solution:  
a) Nickel forms a **metallic solid** since nickel is a metal whose atoms are held together by metallic bonds.  
b) Fluorine forms a **molecular solid** since the F<sub>2</sub> molecules have covalent bonds and the molecules are held to each other by dispersion forces.  
c) Methanol forms a **molecular solid** since the covalently bonded CH<sub>3</sub>OH molecules are held to each other by hydrogen bonds.  
d) Tin forms a **metallic solid** since tin is a metal whose atoms are held together by metallic bonds.  
e) Silicon is in the same group as carbon, so it exhibits similar bonding properties. Since diamond and graphite are both **network covalent** solids, it makes sense that Si forms the same type of bonds.  
f) Xe is an **atomic** solid since individual atoms are held together by dispersion forces.
- 12.71 a) **Network covalent**, since this is similar to diamond.  
b) **Ionic**, since it consists of ions.  
c) **Molecular**, since this is a molecule.  
d) **Molecular**, since this is a molecule.  
e) **Ionic**, since it is an ionic compound.  
f) **Network covalent**, since this substance is isoelectronic with C (diamond).
- 12.72 Figure P12.73 shows the face-centered cubic array of zinc blende, ZnS. Both ZnS and ZnO have a 1:1 ion ratio, so the ZnO unit cell will also contain **four** Zn<sup>2+</sup> ions.
- 12.73 Figure P12.73 shows the face-centered cubic array of calcium sulfide, CaS. Both CaS and NaCl have a 1:1 ion ratio, so the CaS unit cell will also contain **four** S<sup>2-</sup> ions.
- 12.74 Plan: To determine the number of Zn<sup>2+</sup> ions and Se<sup>2-</sup> ions in each unit cell count the number of ions at the corners, faces, and center of the unit cell. Atoms at the eight corners are shared by eight cells for a total of 8 atoms  $\times$  1/8 atom per cell = 1 atom; atoms in the body of a cell are in that cell only; atoms at the faces are shared by two cells: 6 atoms  $\times$  1/2 atom per cell = 3 atoms. Add the masses of the total number of atoms in the cell to find the mass of the cell. Given the mass of one unit cell and the ratio of mass to volume (density) divide the mass, converted to grams (conversion factor is 1 amu = 1.66054  $\times$  10<sup>-24</sup> g), by the density to find the volume of the



unit cell. Since the volume of a cube is length x width x height, the edge length is found by taking the cube root of the cell volume.

Solution:

a) Looking at selenide ions, there is one ion at each corner and one ion on each face. The total number of selenide ions is  $1/8$  (8 corner ions) +  $1/2$  (6 face ions) = **4 Se<sup>2-</sup> ions**. There are also **4 Zn<sup>2+</sup> ions** due to the 1:1 ratio of Se ions to Zn ions.

b) Mass of unit cell = (4 x mass of Zn atom) + (4 x mass of Se atom)  
 = (4 x 65.41 amu) + (4 x 78.96 amu) = **577.48 amu**

c) Volume (cm<sup>3</sup>) = (577.48 amu)  $\left(\frac{1.66054 \times 10^{-24} \text{ g}}{1 \text{ amu}}\right) \left(\frac{\text{cm}^3}{5.42 \text{ g}}\right)$  =  $1.76924 \times 10^{-22}$  = **1.77 x 10<sup>-22</sup> cm<sup>3</sup>**

d) The volume of a cube equals (length of edge)<sup>3</sup>.

Edge length (cm) =  $\sqrt[3]{1.76924 \times 10^{-22} \text{ cm}^3}$  =  $5.6139 \times 10^{-8}$  = **5.61 x 10<sup>-8</sup> cm**

12.75 a) A face-centered cubic unit cell contains **four atoms**.

b) Volume =  $(4.52 \times 10^{-8} \text{ cm})^3$  =  $9.23454 \times 10^{-23}$  = **9.23 x 10<sup>-23</sup> cm<sup>3</sup>**

c) Mass of unit cell =  $(1.45 \text{ g/cm}^3)(9.23454 \times 10^{-23} \text{ cm}^3)$  =  $1.3390 \times 10^{-22}$  = **1.34 x 10<sup>-22</sup> g**

d) Mass of atom =  $\left(\frac{1.3390 \times 10^{-22} \text{ g}}{1 \text{ unit cell}}\right) \left(\frac{1 \text{ kg}}{10^3 \text{ g}}\right) \left(\frac{1 \text{ amu}}{1.66054 \times 10^{-27} \text{ kg}}\right) \left(\frac{1 \text{ unit cell}}{4 \text{ atoms}}\right)$   
 = 20.1592 = **20.2 amu/atom**

12.76 Plan: To classify a substance according to its electrical conductivity, first locate it on the periodic table as a metal, metalloid, or nonmetal. In general, metals are conductors, metalloids are semiconductors, and nonmetals are insulators.

Solution:

a) Phosphorous is a nonmetal and an **insulator**.

b) Mercury is a metal and a **conductor**.

c) Germanium is a metalloid in Group 4A(14) and is beneath carbon and silicon in the periodic table. Pure germanium crystals are **semiconductors** and are used to detect gamma rays emitted by radioactive materials. Germanium can also be doped with phosphorous (similar to the doping of silicon) to form an n-type semiconductor or be doped with lithium to form a p-type semiconductor.

12.77 Plan: First, classify the substance as an insulator, conductor, or semiconductor. The electrical conductivity of conductors decreases with increasing temperature, whereas that of semiconductors increases with temperature. Temperature increases have little impact on the electrical conductivity of insulators.

Solution:

a) Antimony, Sb, is a metalloid, so it is a semiconductor. Its electrical conductivity **increases** as the temperature increases.

b) Tellurium, Te, is a metalloid, so it is a semiconductor. Its electrical conductivity **increases** as temperature increases.

c) Bismuth, Bi, is a metal, so it is a conductor. Its electrical conductivity **decreases** as temperature increases.

12.78 Rb ([Kr]5s<sup>1</sup>) has one valence electron, so the metallic bonding would be fairly weak, resulting in a soft, low-melting material. Cd ([Kr]5s<sup>2</sup>4d<sup>10</sup>) has two valence electrons so the metallic bonding is stronger. V ([Ar]4s<sup>2</sup>3d<sup>3</sup>) has five valence electrons, so its metallic bonding is the strongest, that is, its hardness, melting point, and other metallic properties would be greatest.

12.79 a) Edge of unit cell =  $\sqrt[3]{\left(\frac{95.94 \text{ g Mo}}{1 \text{ mol Mo}}\right) \left(\frac{\text{cm}^3}{10.28 \text{ g}}\right) \left(\frac{1 \text{ mol Mo}}{6.022 \times 10^{23} \text{ Mo atoms}}\right) (2 \text{ Mo atoms})}$   
 =  $3.1412218 \times 10^{-8}$  = **3.141 x 10<sup>-8</sup> cm**

b) The body-diagonal of a body-centered cubic unit cell is equal to four times the radius of the Mo atom. The body-diagonal is also =  $\sqrt{3}$  times the length of the unit cell edge.

$$4r = \sqrt{3}(3.1412218 \times 10^{-8} \text{ cm}) = 5.4407559 \times 10^{-8} \text{ cm}$$

$$r = 1.360189 \times 10^{-8} = \mathbf{1.360 \times 10^{-8} \text{ cm}}$$

12.80 Volume =  $\left(\frac{\text{cm}^3}{3.62 \text{ g}}\right)\left(\frac{137.3 \text{ g}}{1 \text{ mol Ba}}\right) = 37.9281768 \text{ cm}^3/\text{mol Ba}$

Volume/mol of Ba atoms = volume/mol Ba x packing efficiency

The packing efficiency in the body-centered cubic unit cell is 68%.

$$\text{Volume/mol of Ba atoms} = 37.9281768 \text{ cm}^3/\text{mol Ba} \times 0.68 = 25.791116 \text{ cm}^3/\text{mol Ba atoms}$$

$$\text{Volume of one Ba atom} = \left(\frac{25.791116 \text{ cm}^3}{1 \text{ mol Ba atoms}}\right)\left(\frac{1 \text{ mol Ba atoms}}{6.022 \times 10^{23} \text{ Ba atoms}}\right) = 4.28282 \times 10^{-23} \text{ cm}^3/\text{atom}$$

Use the volume of a sphere to find the radius of the Ba atom:

$$V = \frac{4}{3}\pi r^3$$

$$r = \sqrt[3]{\frac{3V}{4\pi}} = \sqrt[3]{\frac{3(4.28282 \times 10^{-23} \text{ cm}^3)}{4\pi}} = 2.17044 \times 10^{-8} = \mathbf{2.17 \times 10^{-8} \text{ cm}}$$

- 12.81 a) I, II, III, V  
 b) IV  
 c) V → IV → liquid → I  
 d) Triple point: I, II, liquid  
 Triple point: II, IV, liquid  
 Triple point: II, III, IV  
 Triple point: III, IV, V  
 Triple point: IV, V, liquid

12.82 Plan: The Clausius-Clapeyron equation gives the relationship between vapor pressure and temperature. We are given  $P_1$ ,  $P_2$ ,  $T_1$ , and  $\Delta H_{\text{vap}}^\circ$ ; these values are substituted into the equation to find  $T_2$ .

Solution:

$$\ln \frac{P_2}{P_1} = -\frac{\Delta H_{\text{vap}}^\circ}{R} \left( \frac{1}{T_2} - \frac{1}{T_1} \right) \quad P_1 = 1.20 \times 10^{-3} \text{ torr} \quad T_1 = 20.0^\circ\text{C} + 273 = 293 \text{ K}$$

$$P_2 = 5.0 \times 10^{-5} \text{ torr} \quad T_2 = ? \quad \Delta H_{\text{vap}}^\circ = 59.1 \text{ kJ/mol}$$

$$\ln \frac{5.0 \times 10^{-5} \text{ torr}}{1.20 \times 10^{-3} \text{ torr}} = \frac{-59.1 \text{ kJ/mol}}{8.314 \text{ J/mol}\cdot\text{K}} \left( \frac{1}{T_2} - \frac{1}{293 \text{ K}} \right) \left( \frac{10^3 \text{ J}}{1 \text{ kJ}} \right)$$

$$-3.178054 = -7108.492 \left( \frac{1}{T_2} - \frac{1}{293 \text{ K}} \right)$$

$$(-3.178054)/(-7108.49) = 4.47078 \times 10^{-4} = \left( \frac{1}{T_2} - \frac{1}{293 \text{ K}} \right)$$

$$4.47078 \times 10^{-4} + 1/293 = 1/T_2$$

$$T_2 = 259.064 = \mathbf{259 \text{ K}}$$

- 12.83 a) A: solid      E: solid + liquid      F: liquid + gas  
 H: liquid      B: liquid + solid + gas      C: gas  
 b) Critical point: D      Triple point: B  
 c) BG  
 d) The substance is a solid, which would melt and then boil.

- e) The substance is a liquid, which would vaporize.  
 f) The liquid is denser than the solid.

12.84 **Plan:** Add up the number of atoms in the unit cell. An atom at a corner counts 1/8 of an atom, an atom in the center counts as one atom, and an atom on an edge counts as 1/4 of an atom. Use the edge length of the cell to calculate the volume of the cell; the mass of the cell divided by the volume gives the density.

**Solution:**

a) The cell contents are one Ca,  $8 \times (1/8) = 1$  Ti, and  $12 \times (1/4) = 3$  O, or one  $\text{CaTiO}_3$  formula unit. The presence of one formula unit per unit cell indicates a **simple cubic** unit cell.

$$\text{b) Mass (g) of the unit cell} = \left( \frac{1 \text{ CaTiO}_3}{\text{unit cell}} \right) \left( \frac{1 \text{ mol CaTiO}_3}{6.022 \times 10^{23} \text{ CaTiO}_3} \right) \left( \frac{135.96 \text{ g CaTiO}_3}{1 \text{ mol CaTiO}_3} \right) = 2.257722 \times 10^{-22} \text{ g}$$

$$\text{Volume (cm}^3\text{) of the unit cell} = \left( \frac{(3.84 \text{ \AA})^3}{\text{unit cell}} \right) \left( \frac{10^{-8} \text{ cm}}{1 \text{ \AA}} \right)^3 = 5.6623 \times 10^{-23} \text{ cm}^3$$

$$\text{Density} = \frac{2.257722 \times 10^{-22} \text{ g}}{5.6623 \times 10^{-23} \text{ cm}^3} = 3.98729 = \mathbf{3.99 \text{ g/cm}^3}$$

12.85 The density of Fe is  $7.874 \text{ g/cm}^3$ , but Fe atoms occupy only 68% of the volume in a body-centered cubic cell. Calculate the volume/mole Fe ratio, and multiply by 0.68 to determine the volume/mol Fe atoms ratio. Dividing by the volume of a single Fe will yield the units of atoms/mol, which is Avogadro's number.

$$\text{Molar volume of Fe} = (55.85 \text{ g/mol}) / (7.874 \text{ g/cm}^3) = 7.09296 \text{ cm}^3/\text{mol Fe}$$

The volume of just the atoms (not including the empty spaces between atoms) is:

$$\text{Volume/mole Fe atoms} = (7.09296 \text{ cm}^3/\text{mol Fe})(68\% / 100\%) = 4.82321 \text{ cm}^3/\text{mol Fe atoms}$$

The number of atoms in one mole of Fe is obtained by dividing by the volume of one Fe atom:

$$\begin{aligned} \text{Atoms/mol} &= (4.82321 \text{ cm}^3/\text{mol Fe atoms})(1 \text{ Fe atom}/8.38 \times 10^{-24} \text{ cm}^3) \\ &= 5.7556 \times 10^{23} = \mathbf{5.8 \times 10^{23} \text{ atoms/mol}} \end{aligned}$$

12.86 The number of anions that can fit around a cation depends on the relative sizes of the two ions, or the ratio  $r_+/r_-$ . The large size of the  $\text{Cs}^+$  ion allows for eight anions ( $\text{CN} = 8$ ) to fit around the cation in a cubic arrangement, while the smaller size  $\text{Na}^+$  ion can only fit six anions ( $\text{CN} = 6$ ). With this additional contact, the high polarizability of the large ions allows for strong dispersion forces, which favor the CsCl structure.

12.87 The formulas are **TaN and TaC**.

12.88 In the NaCl type lattice, there are four ions of each type.

$$\begin{aligned} \text{Density of KF} &= \left( \frac{4 \text{ KF}}{\text{unit cell}} \right) \left( \frac{1 \text{ mol KF}}{6.022 \times 10^{23} \text{ KF}} \right) \left( \frac{58.10 \text{ g KF}}{1 \text{ mol KF}} \right) \left( \frac{\text{unit cell}}{(5.39 \text{ \AA})^3} \right) \left( \frac{1 \text{ \AA}}{10^{-8} \text{ cm}} \right)^3 \\ &= 2.46450 = \mathbf{2.46 \text{ g/cm}^3} \end{aligned}$$

12.89 **Plan:** Hydrogen bonds only occur in substances in which hydrogen is directly bonded to either oxygen, nitrogen, or fluorine.

**Solution:**

a) Both **furfuryl alcohol** and 2-furoic acid can form hydrogen bonds since these two molecules have hydrogen directly bonded to oxygen.

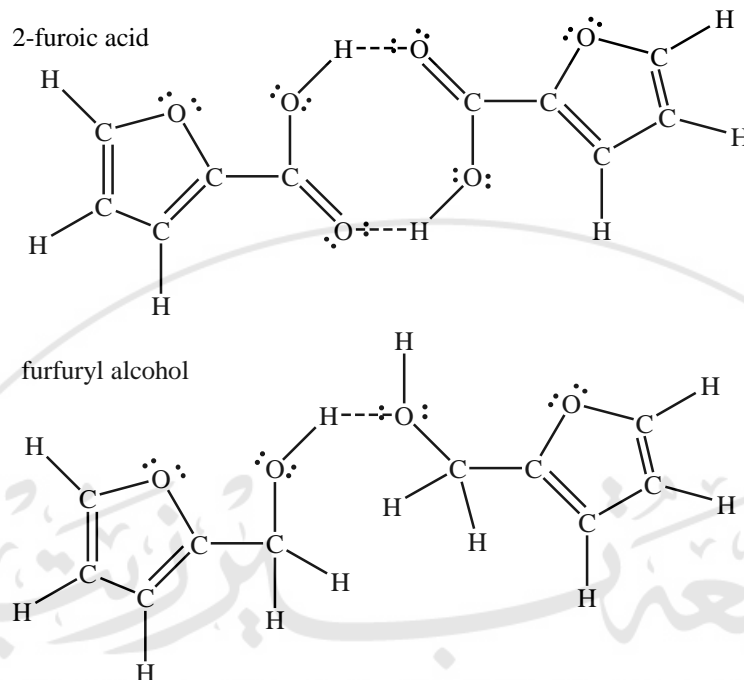

b) Both **furfuryl alcohol** and **2-furoic acid** can form internal hydrogen bonds by forming a hydrogen bond between the O–H and the O in the ring.

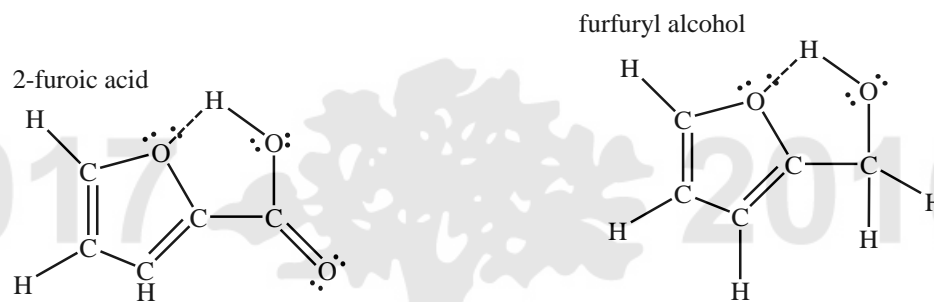

- 12.90 The eight atoms of A are each 1/8 in the cell (i.e., shared by eight cells), so there is a net of one A atom. The six atoms of Z are each 1/2 in the cell (i.e., shared by two cells), so there are three net Z atoms. The compound is **AZ<sub>3</sub>**.
- 12.91 **No**, filling all the available holes (8) in the face-centered cubic lattice leads to a stoichiometry of 2:1 (8 holes/4 atoms).
- 12.92 a) Determine the vapor pressure of ethanol in the bottle at  $-11^{\circ}\text{C}$  by applying the Clausius-Clapeyron equation. The boiling point of ethanol is  $78.5^{\circ}\text{C}$  at a pressure of 1 atm (760 torr).  $\Delta H_{\text{vap}}^{\circ}$  (38.6 kJ/mol) is given in Figure 12.1.

$$\ln \frac{P_2}{P_1} = -\frac{\Delta H_{\text{vap}}^{\circ}}{R} \left( \frac{1}{T_2} - \frac{1}{T_1} \right)$$

$$P_1 = ? \quad T_1 = (273 + (-11^{\circ}\text{C})) = 262 \text{ K}$$

$$P_2 = 760. \text{ torr} \quad T_2 = (273.15 + 78.5^{\circ}\text{C}) = 351.6 \text{ K}$$

$$\Delta H_{\text{vap}}^{\circ} = 38.6 \text{ kJ/mol}$$

$$\ln \frac{760. \text{ torr}}{P_1} = \frac{-38.6 \text{ kJ/mol}}{8.314 \text{ J/mol}\cdot\text{K}} \left( \frac{1}{351.6 \text{ K}} - \frac{1}{262 \text{ K}} \right) \left( \frac{10^3 \text{ J}}{1 \text{ kJ}} \right) = 4.515804546$$

$$\frac{760. \text{ torr}}{P_1} = 91.45111307$$

$$P_1 = 8.31045 \text{ torr}$$

Note: The pressure should be small because not many ethanol molecules escape the liquid surface at such a cold temperature.

Determine the number of moles by substituting  $P$ ,  $V$ , and  $T$  into the ideal gas equation. Assume that the volume the liquid takes up in the 4.7 L space is negligible.

$$n = \frac{PV}{RT} = \frac{(8.31045 \text{ torr})(4.7 \text{ L})}{\left(0.0821 \frac{\text{L}\cdot\text{atm}}{\text{mol}\cdot\text{K}}\right)(262 \text{ K})} \left(\frac{1 \text{ atm}}{760 \text{ torr}}\right) = 0.0023892652 \text{ mol C}_2\text{H}_6\text{O}$$

Convert moles of ethanol to mass of ethanol using the molar mass ( $\mathcal{M} = 46.07 \text{ g/mol}$ ).

$$\text{Mass (g) of C}_2\text{H}_6\text{O} = (0.0023892652 \text{ mol C}_2\text{H}_6\text{O})(46.07 \text{ g/mol C}_2\text{H}_6\text{O}) = 0.11007345 = \mathbf{0.11 \text{ g C}_2\text{H}_6\text{O}}$$

$$\text{b) } \ln \frac{P_2}{P_1} = -\frac{\Delta H_{\text{vap}}^\circ}{R} \left( \frac{1}{T_2} - \frac{1}{T_1} \right) \quad P_1 = ? \quad T_1 = (273 + 20.^\circ\text{C}) = 293 \text{ K}$$

$$P_2 = 760. \text{ torr} \quad T_2 = (273.15 + 78.5^\circ\text{C}) = 351.6 \text{ K}$$

$$\Delta H_{\text{vap}}^\circ = 38.6 \text{ kJ/mol}$$

$$\ln \frac{760. \text{ torr}}{P_1} = \frac{-38.6 \text{ kJ/mol}}{8.314 \text{ J/mol}\cdot\text{K}} \left( \frac{1}{351.6 \text{ K}} - \frac{1}{293 \text{ K}} \right) \left( \frac{10^3 \text{ J}}{1 \text{ kJ}} \right) = 2.640939266$$

$$\frac{760. \text{ torr}}{P_1} = 14.02637191$$

$$P_1 = 54.18365 \text{ torr}$$

Determine the number of moles by substituting  $P$ ,  $V$ , and  $T$  into the ideal gas equation. Assume that the volume the liquid takes up in the 4.7 L space is negligible.

$$n = \frac{PV}{RT} = \frac{(54.18365 \text{ torr})(4.7 \text{ L})}{\left(0.0821 \frac{\text{L}\cdot\text{atm}}{\text{mol}\cdot\text{K}}\right)(293 \text{ K})} \left(\frac{1 \text{ atm}}{760 \text{ torr}}\right) = 0.0139297 \text{ mol C}_2\text{H}_6\text{O}$$

Convert moles of ethanol to mass of ethanol using the molar mass ( $\mathcal{M} = 46.07 \text{ g/mol}$ ).

$$\text{Mass (g) of C}_2\text{H}_6\text{O} = (0.0139297 \text{ mol C}_2\text{H}_6\text{O})(46.07 \text{ g/mol C}_2\text{H}_6\text{O}) = 0.6417413 = 0.64 \text{ g C}_2\text{H}_6\text{O}$$

The mass of ethanol present in the vapor, if excess liquid was present, is 0.64 g. Since this exceeds the 0.33 g available, **all of the ethanol will vaporize.**

$$\text{c) } 0.0^\circ\text{C} = (273.2 + 0.0) = 273.2 \text{ K}$$

$$\ln \frac{P_2}{760 \text{ torr}} = \frac{-38.6 \text{ kJ/mol}}{8.314 \text{ J/mol}\cdot\text{K}} \left( \frac{1}{273.2 \text{ K}} - \frac{1}{351.6 \text{ K}} \right) \left( \frac{10^3 \text{ J}}{1 \text{ kJ}} \right) = -3.789341845$$

$$\frac{P_2}{760 \text{ torr}} = 0.0226104781$$

$$P_2 = (0.0226104781)(760 \text{ torr}) = 17.18396 \text{ torr}$$

$$n = \frac{PV}{RT} = \frac{(17.18396 \text{ torr})(4.7 \text{ L})}{\left(0.0821 \frac{\text{L}\cdot\text{atm}}{\text{mol}\cdot\text{K}}\right)(273.2 \text{ K})} \left(\frac{1 \text{ atm}}{760 \text{ torr}}\right) = 0.0047378757 \text{ mol C}_2\text{H}_6\text{O}$$

Convert moles of ethanol to mass of ethanol using the molar mass ( $\mathcal{M} = 46.07 \text{ g/mol}$ ).

$$\text{Mass C}_2\text{H}_6\text{O} = (0.0047378757 \text{ mol C}_2\text{H}_6\text{O})(46.07 \text{ g/mol C}_2\text{H}_6\text{O}) = 0.2182739 \text{ g C}_2\text{H}_6\text{O}$$

Mass (g) of ethanol in liquid = mass (g) of ethanol (total) – mass (g) of ethanol in vapor

$$\text{Mass (g) of ethanol in liquid} = 0.33 \text{ g} - 0.2182739 \text{ g} = 0.1117261 = \mathbf{0.11 \text{ g C}_2\text{H}_6\text{O}}$$

12.93 Plan: This problem involves carefully examining the figures showing the different cells pictured in the chapter.

Solution:

a) The atoms touch along the body diagonal. The two corner atoms each contribute one radius (r), and the center atom contributes a diameter (2r). The total for the body diagonal = **4r**.

b) The face diagonal is the hypotenuse of a right triangle with the other two sides being the unit cell edge (a). Using the Pythagorean Theorem ( $a^2 + b^2 = c^2$ ) with  $a = b =$  the unit cell edge, and  $c =$  the face diagonal:

$$a^2 + b^2 = c^2$$

$$a^2 + a^2 = 2 a^2 = c^2$$

$$c = \text{face diagonal} = \sqrt{2} a$$

c) The body-diagonal is the hypotenuse (c) of a triangle with one of the other sides being a face-diagonal (b) and the remaining side being a unit cell edge (a). Again, the Pythagorean Theorem is applied.

$$a^2 + b^2 = c^2$$

From part a:

$$a^2 + b^2 = (4r)^2$$

From part b:

$$a^2 + (\sqrt{2} a)^2 = (4r)^2$$

$$a^2 + 2 a^2 = 16r^2$$

Rearranging:

$$3a^2 = 16r^2$$

$$a^2 = \frac{16r^2}{3}$$

$$a = \frac{4r}{\sqrt{3}}$$

d) A body-centered cubic unit cell contains **2 atoms**. There is one atom in the center of the cell; eight atoms in the corners are each 1/8 in the cell (i.e., shared by eight cells), so there is a net of one more atom – 1/8 x 8.

e) Fraction filled = (volume of atoms present)/(volume of unit cell)  
= [2 atoms x volume of one atom]/(answer from part c)

Find the volume of one atom using the equation for the volume of a sphere:  $\frac{4}{3} \pi r^3$

Find the volume of the unit cell by cubing the value of the edge length from part c:

Volume of a cube = length x width x height

$$\text{Fraction filled} = \frac{2 \left[ \frac{4}{3} \pi r^3 \right]}{\left[ \frac{4r}{\sqrt{3}} \right]^3} = \frac{8.37758r^3}{12.3168r^3} = \mathbf{0.68017}$$

12.94 a) **A and B** can form intermolecular H bonds since both have a hydrogen atom bonded to an oxygen atom.

b) Highest viscosity = strongest intermolecular forces. **B** has the highest viscosity.