

Reinforced Concrete Design I

ENCE 335

Bond, Development length, standard hooks and lap splices

Dr. Khalil M. Qatu

Typical detailing

- ◆ We learned before the required extension for flexural reinforcement
- ◆ But this only applies for specific conditions
 - ◆ Applied load must be uniformly distributed
 - ◆ Equal spans
 - ◆ etc.

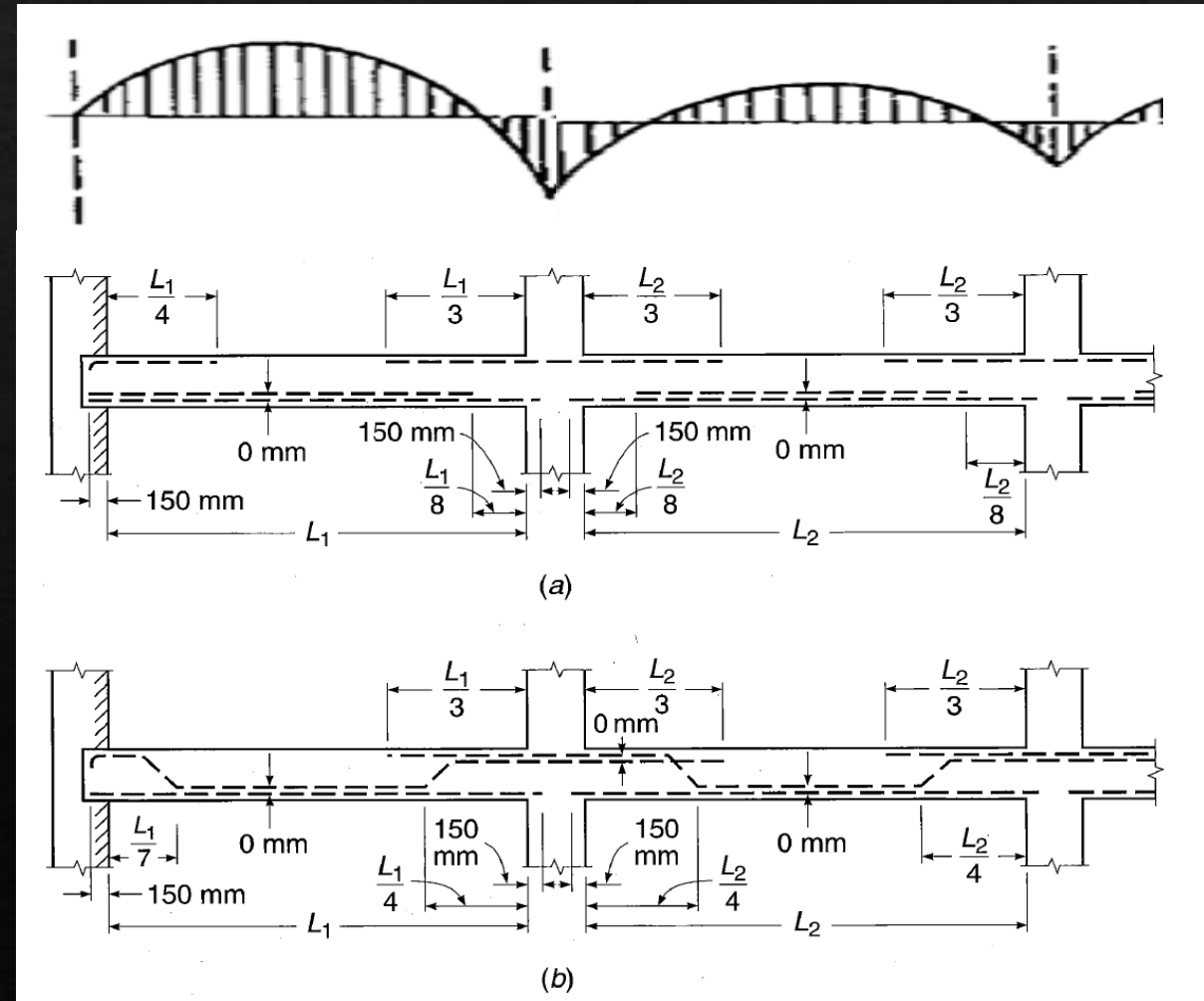

General loading

- ◆ Reinforcement is only needed in tension zones
- ◆ We can cut the bars when moment is zero
- ◆ For the given moment diagrams, What is the location and extension of the reinforcement?
- ◆ However, The bar need to perfectly bonded with the concrete to act as one material!!!
- ◆ So far, we assumed a perfect bond between the steel and the concrete

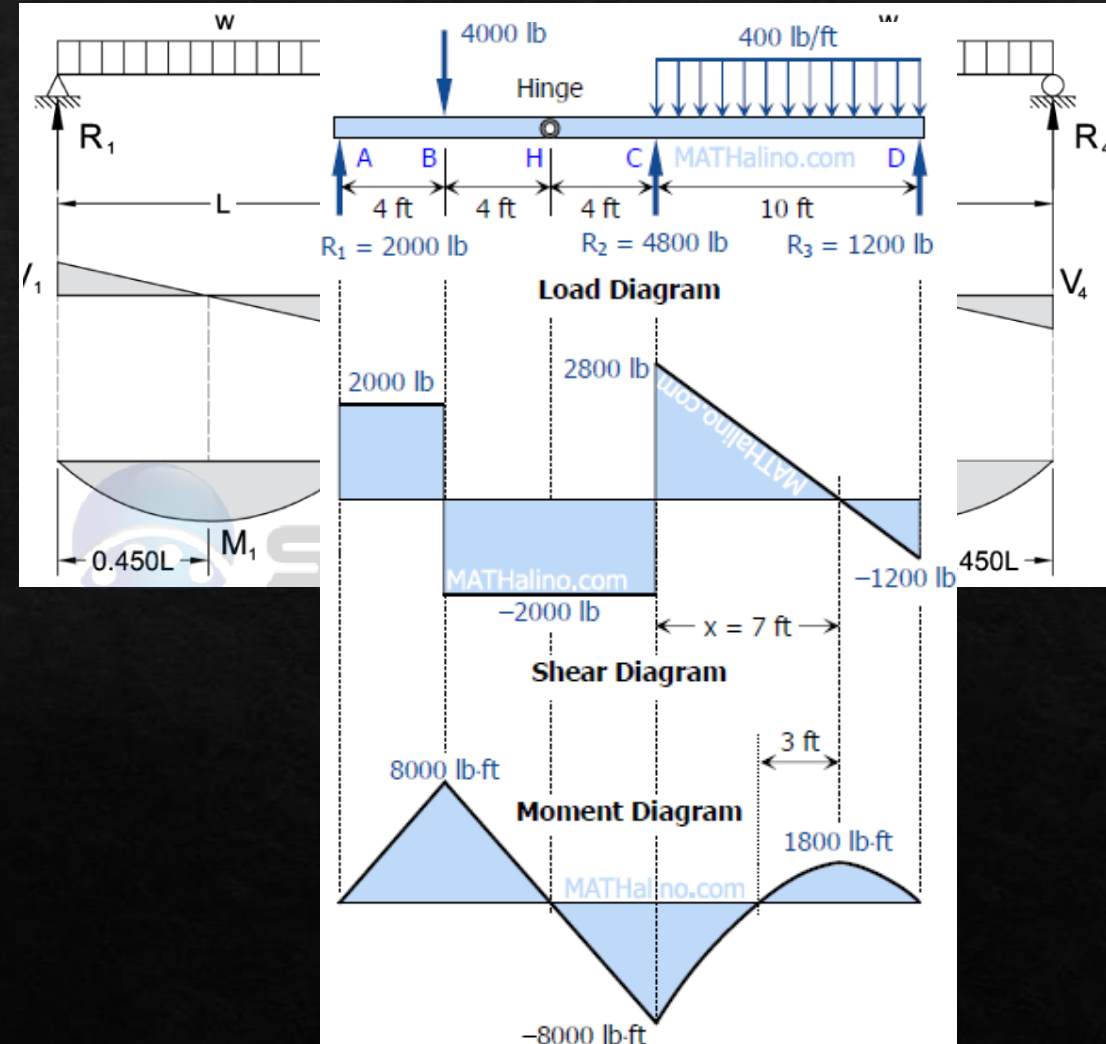

Bond strength

◆ Sources of bond strength

◆ Adhesion between concrete & reinforcement.

◆ Friction

These properties ↑ are quickly lost in tension.

◆ Mechanical Interlock. (that's why steel bars are corrugated)

◆ The edge stress concentration causes cracking to occur.

◆ Splitting failure will occur if bars are not properly spaced

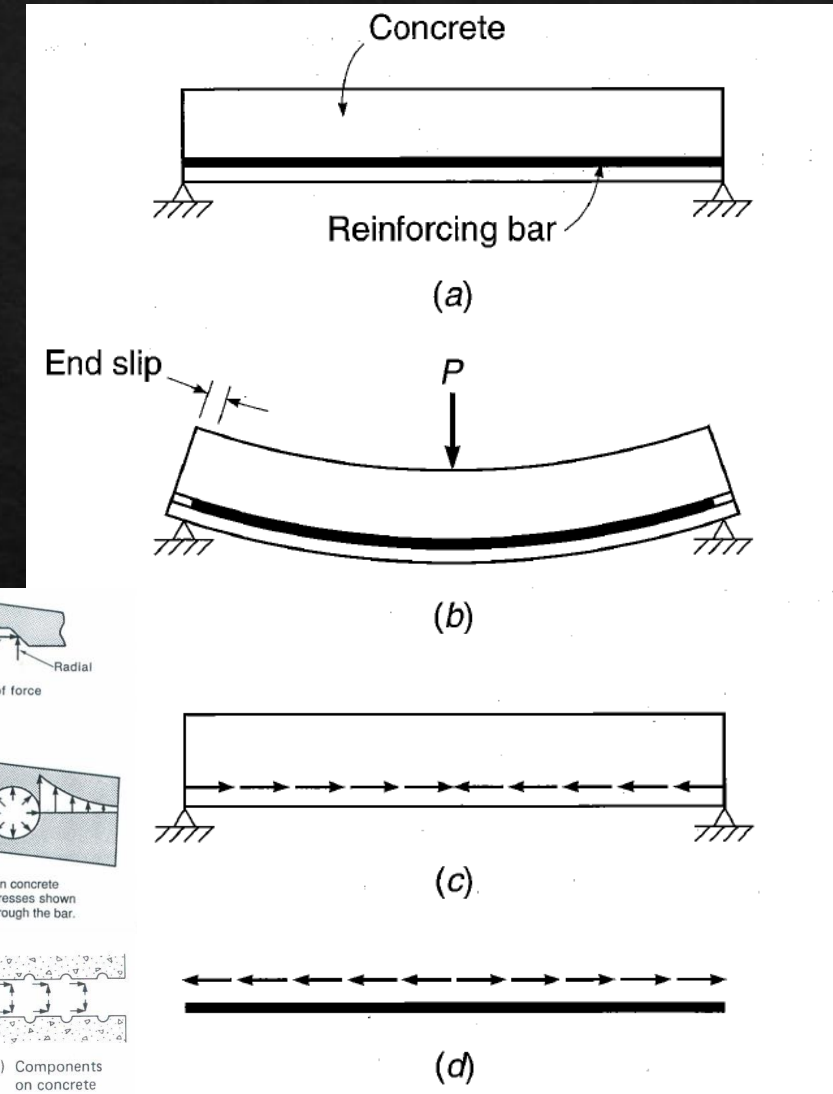
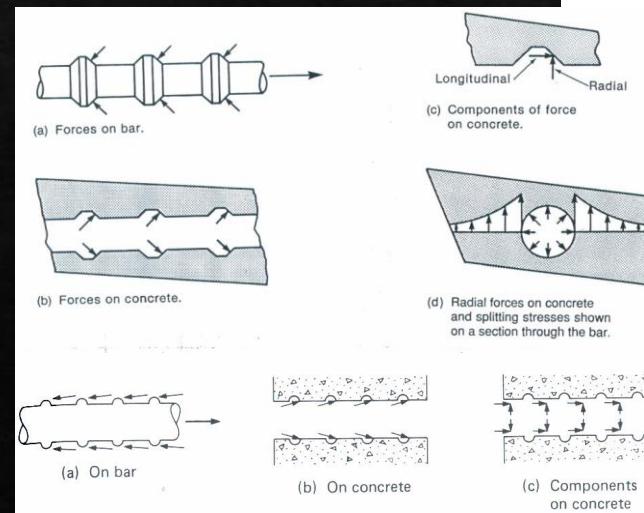
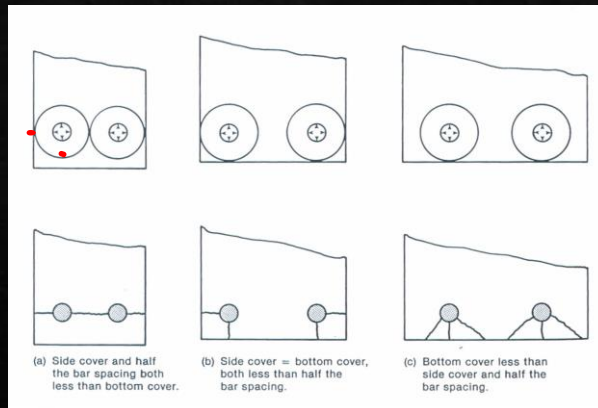

Bond strength

- ◆ Such splitting comes largely from wedging action when the ribs of the deformed bar bear against the concrete.
- ◆ The horizontal type of splitting frequently begins at a diagonal crack.
- ◆ The dowel action increases the tendency toward splitting.
- ◆ This indicates that shear and bond failure are often intricately interrelated.

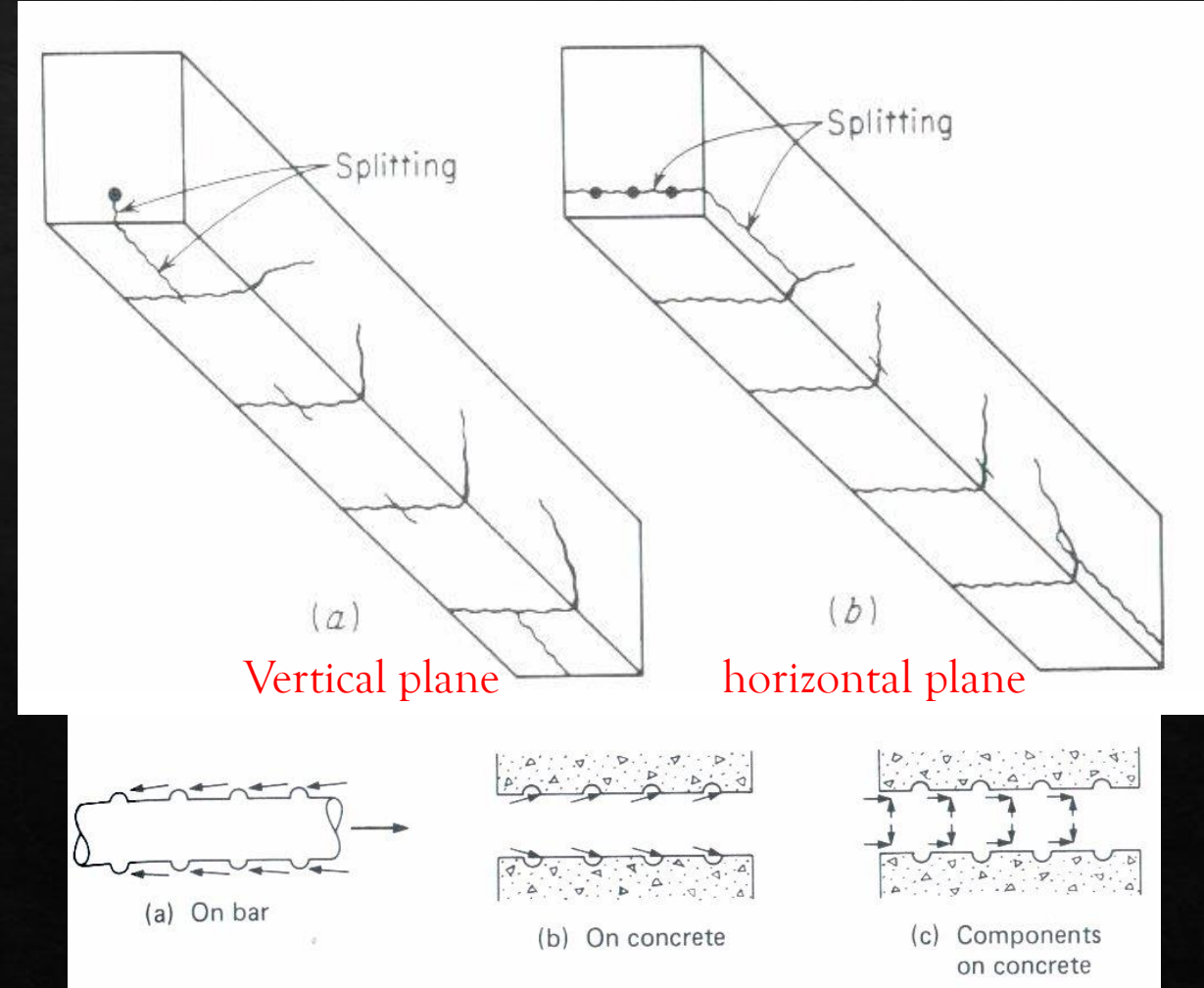

Bond strength

- ◆ The tension force in the bar is developed due to loading
- ◆ The full tension in the bar remains till the point of zero moment. (i.e., No internal moment → No tension)
- ◆ To avoid bond failure, the tension force in the bar must be transferred gradually to the concrete after the point of zero moment.
- ◆ The distance required to achieve this transfer is called the **DEVELOPMENT LENGTH (l_d)**

Shortest length of bar in which the bar stress can increase from zero to the yield strength, f_y .

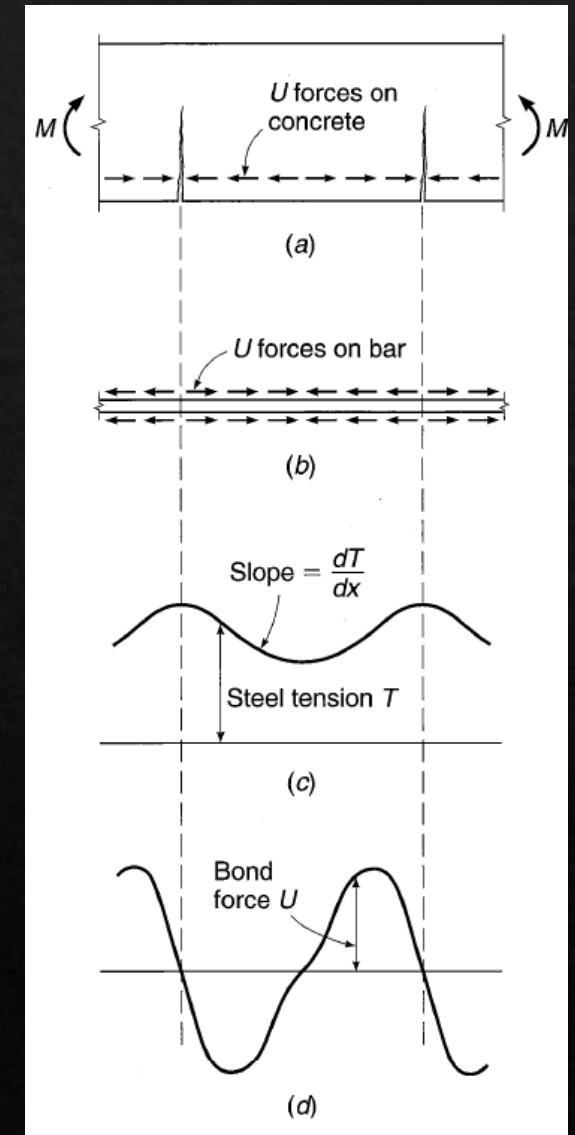
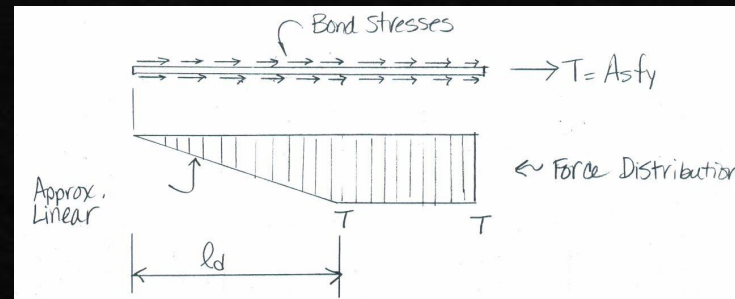

Development length

$$\sum F = 0. \Rightarrow T - \text{Bond Force} = 0$$

$$\Rightarrow \frac{\pi d_b^2}{4} f_y - \pi d_b l_b \mu = 0$$

$$\Rightarrow l_d = \frac{f_y d_b}{4\mu}$$

μ = bond stress (coefficient of friction) $\approx k \sqrt{f_c}$

$k = f(\varphi \text{ bar})$

$$l_d = \frac{f_y}{1.1\lambda\sqrt{f_c'}} \frac{\Psi_t \Psi_e \Psi_s \Psi_g}{\left(\frac{c_b + K_{tr}}{d_b}\right)} d_b$$

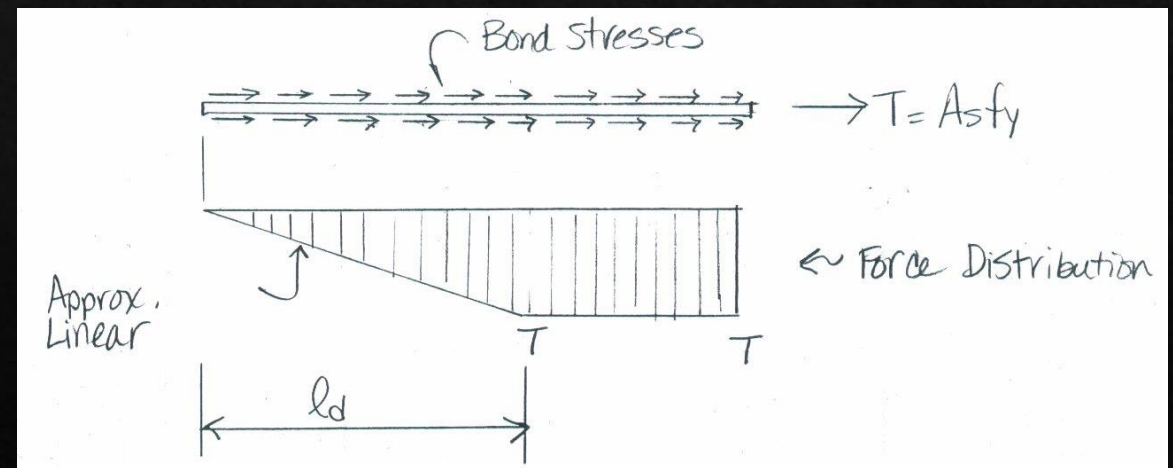
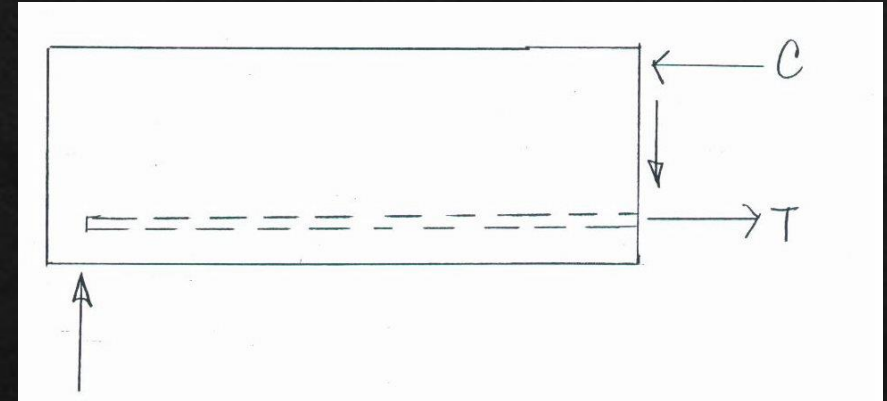

Development length

◆ ACI requirements for bars in tension

- ◆ c_b is a factor that represents the least of the side cover, the concrete cover to the bar or wire (in both cases measured to the center of the bar or wire), or one-half the center-to-center spacing of the bars or wires
- ◆ K_{tr} is a factor that represents the contribution of confining reinforcement across potential splitting planes. It shall be permitted to use $K_{tr} = 0$ as a design simplification even if transverse reinforcement is present or required.
- ◆ ψ_t is the reinforcement location factor to reflect the effect of the casting position (that is, formerly denoted as “top bar effect”).
- ◆ ψ_e is a coating factor reflecting the effects of epoxy coating. There is a limit on the product $\psi_t\psi_e$.
- ◆ ψ_s reinforcement size factor reflects the more favorable performance of smaller diameter reinforcement
- ◆ ψ_g is the reinforcement grade factor accounting for the yield strength of the reinforcement

$$l_d = \frac{f_y}{1.1\lambda\sqrt{f'_c}} \frac{\psi_t\psi_e\psi_s\psi_g}{\left(\frac{c_b + K_{tr}}{d_b}\right)} d_b$$

$$K_{tr} = \frac{40A_{tr}}{sn}$$

Table 25.4.2.5—Modification factors for development of deformed bars and deformed wires in tension

Modification factor	Condition	Value of factor
Lightweight λ	Lightweight concrete	0.75
	Normalweight concrete	1.0
Reinforcement grade ψ_g	Grade 280 or Grade 420	1.0
	Grade 550	1.15
	Grade 690	1.3
Epoxy ^[1] ψ_e	Epoxy-coated or zinc and epoxy dual-coated reinforcement with clear cover less than $3d_b$ or clear spacing less than $6d_b$	1.5
	Epoxy-coated or zinc and epoxy dual-coated reinforcement for all other conditions	1.2
	Uncoated or zinc-coated (galvanized) reinforcement	1.0
Size ψ_s	No. 22 and larger bars	1.0
	No. 19 and smaller bars and deformed wires	0.8
Casting position ^[1] ψ_t	More than 300 mm of fresh concrete placed below horizontal reinforcement	1.3
	Other	1.0

^[1]The product $\psi_t\psi_e$ need not exceed 1.7.

Development length

◆ ACI requirements for bars in tension : Simplified equations

◆ For example:

In all members with normal weight concrete ($\lambda = 1.0$), uncoated reinforcement ($\psi_e = 1.0$), No. 22 and larger bottom bars ($\psi_t = 1.0$) with $f_c' = 28$ MPa, and Grade 420 reinforcement ($\psi_g = 1.0$)

- ◆ If minimum cover of d_b is provided along with a minimum clear spacing of $2d_b$,
- ◆ or a minimum clear cover of d_b and a minimum clear spacing of d_b are provided along with minimum ties or stirrups

$$\ell_d = \frac{(420)(1.0)(1.0)(1.0)}{1.7(1.0)\sqrt{28}} d_b = 47d_b$$

- ◆ The penalty for spacing bars closer or providing less cover is the requirement that $\ell_d = 71d_b$

Table 25.4.2.3—Development length for deformed bars and deformed wires in tension

Spacing and cover	No. 19 and smaller bars and deformed wires	No. 22 and larger bars
Clear spacing of bars or wires being developed or lap spliced not less than d_b , clear cover at least d_b , and stirrups or ties throughout ℓ_d not less than the Code minimum or Clear spacing of bars or wires being developed or lap spliced at least $2d_b$ and clear cover at least d_b	$\left(\frac{f_y \psi_t \psi_e \psi_g}{2.1 \lambda \sqrt{f_c'}} \right) d_b$	$\left(\frac{f_y \psi_t \psi_e \psi_g}{1.7 \lambda \sqrt{f_c'}} \right) d_b$
Other cases	$\left(\frac{f_y \psi_t \psi_e \psi_g}{1.4 \lambda \sqrt{f_c'}} \right) d_b$	$\left(\frac{f_y \psi_t \psi_e \psi_g}{1.1 \lambda \sqrt{f_c'}} \right) d_b$

Development length

◆ ACI requirements for bars in tension : Simplified equations

TABLE A.10

Simplified tension development in bar diameters l_d/d_b for uncoated bars and normalweight concrete

	f_y , MPa	No. 19 (No. 6) and Smaller ^a			No. 22 (No. 7) and Larger		
		f'_c , MPa			f'_c , MPa		
		28	35	42	28	35	42
(1) Bottom bars •							
Spacing, cover and ties as per Case <i>a</i> and <i>b</i>	280	25	23	21	31	28	25
	420	38	34	31	47	42	38
	520	47	42	38	58	52	47
Other cases	280	38	34	31	48	43	39
	420	57	51	46	72	65	59
	520	70	63	57	89	80	73
(2) Top bars •							
Spacing, cover and ties as per Case <i>a</i> and <i>b</i>	280	33	29	27	40	36	33
	420	49	44	40	61	54	50
	520	61	54	50	75	67	61
Other cases	280	49	44	40	63	56	51
	420	74	66	60	94	84	77
	520	91	82	75	116	104	95

Case *a*: Clear spacing of bars being developed or spliced $\geq d_b$, clear cover $\geq d_b$, and stirrups or ties throughout l_d not less than the Code minimum.

Case *b*: Clear spacing of bars being developed or spliced $\geq 2d_b$, and clear cover not less than d_b .

^aACI Committee 408 recommends that the values indicated for bar sizes No. 22 (No. 7) and larger be used for all bar sizes.

Development length

- ◇ ACI requirements for bars in compression (l_{dc})
 - ◇ weakening effect of flexural tension cracks is not present for bars and wires in compression
 - ◇ Usually end bearing of the bars on the concrete is beneficial.
 - ◇ Therefore, shorter development lengths are specified for compression than for tension.
 - ◇ The development length may be reduced 25 percent when the reinforcement is enclosed within closely spaced spirals, ties, or hoops.

$$\left(\frac{0.24 f_y \psi_r}{\lambda \sqrt{f'_c}} \right) d_b$$

Or

$$0.043 f_y \psi_r d_b$$

- ◇ Minimum development length in compression is 200mm

Table 25.4.9.3—Modification factors for deformed bars and wires in compression

Modification factor	Condition	Value of factor
Lightweight λ	Lightweight concrete	0.75
	Normalweight concrete	1.0
Confining reinforcement ψ_r	Reinforcement enclosed within (1), (2), (3), or (4): (1) a spiral (2) a circular continuously wound tie with $d_b \geq 6$ mm and pitch 100 mm (3) No. 13 bar or MD130 wire ties in accordance with 25.7.2 spaced ≤ 100 mm on center (4) hoops in accordance with 25.7.4 spaced ≤ 100 mm on center	0.75
	Other	1.0

Development length

◆ ACI requirements for bars in compression (l_{dc}): Simplified equations

TABLE A.11
Development length in compression, mm, for normalweight concrete
 l_{dc} = greater of $(0.24f_y/\sqrt{f_c})d_b$ or $0.043f_yd_b$ (Minimum of 200 mm in all cases)

Bar No.	Inch-Pound	f_y , MPa	f_c , MPa							
			21		28		35		42	
			Basic l_{dc}	Confined	Basic l_{dc}	Confined	Basic l_{dc}	Confined	Basic l_{dc}	Confined
10	3	280	200	200	200	200	200	200	200	200
		420	210	200	200	200	200	200	200	200
		520	260	200	220	200	210	200	210	200
13	4	280	200	200	200	200	200	200	200	200
		420	280	210	240	200	230	200	230	200
		520	350	260	300	220	280	210	280	210
16	5	280	230	200	200	200	200	200	200	200
		420	350	260	300	230	290	220	290	220
		520	430	320	380	280	360	270	360	270
19	6	280	280	210	240	200	230	200	230	200
		420	420	320	360	270	340	260	340	260
		520	520	390	450	340	430	320	430	320
22	7	280	330	240	280	210	270	200	270	200
		420	490	370	420	320	400	300	400	300
		520	600	450	520	390	500	370	500	370
25	8	280	370	280	320	240	310	230	310	230
		420	560	420	480	360	460	340	460	340
		520	690	520	600	450	570	430	570	430

29	9	280	420	320	360	270	350	260	350	260
		420	630	470	550	410	520	390	520	390
		520	780	590	680	510	640	480	640	480
32	10	280	470	360	410	310	390	290	390	290
		420	710	530	620	460	580	440	580	440
		520	880	660	760	570	720	540	720	540
36	11	280	520	390	450	340	430	320	430	320
		420	790	590	680	510	650	480	650	480
		520	970	730	840	630	800	600	800	600
43	14	280	630	470	550	410	520	390	520	390
		420	950	710	820	610	780	580	780	580
		520	1,170	880	1,010	760	960	720	960	720
57	18	280	840	630	730	550	690	520	690	520
		420	1,260	950	1,090	820	1,030	780	1,030	780
		520	1,560	1,170	1,350	1,010	1,280	960	1,280	960

Development length

- ◇ Reduction of development length for excess reinforcement

$$\text{Reduction factor} = (A_s \text{ req'd}) / (A_s \text{ provided}) \text{ OR } \frac{M_n(\text{req'd})}{M_n(\text{provided})}$$

- ◇ A reduction of development length in accordance is not permitted for :
 - ◇ At noncontinuous supports
 - ◇ At locations where anchorage or development for f_y is required
 - ◇ Where bars are required to be continuous
 - ◇ For hooked, headed, and mechanically anchored deformed reinforcement
 - ◇ In seismic-force-resisting systems in structures assigned to Seismic Design Categories C, D, E, or F
 - ◇ Anchorage of concrete piles and concrete filled pipe piles to pile caps in structures assigned to Seismic Design Categories C, D, E, or F
- ◇ Good practice to ignore this provision, since use of structure may change over time.

Standard Hooks and Anchorage

- ◆ In some cases, the actual available length for development is less than the calculated development length
- ◆ Hooks are not allowed to developed compression reinforcement.

Table 25.3.1—Standard hook geometry for development of deformed bars in tension

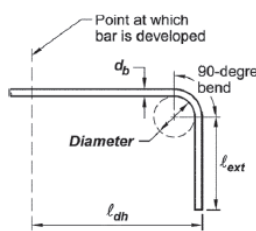
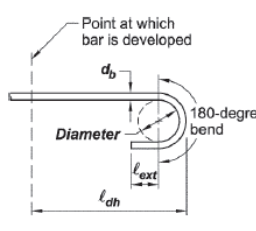
Type of standard hook	Bar size	Minimum inside bend diameter, mm	Straight extension ^[1] ℓ_{ext} mm	Type of standard hook
90-degree hook	No. 10 through No. 25	$6d_b$	12 d_b	
	No. 29 through No. 36	$8d_b$		
	No. 43 through No. 57	$10d_b$		
180-degree hook	No. 10 through No. 25	$6d_b$	Greater of $4d_b$ and 65 mm	
	No. 29 through No. 36	$8d_b$		
	No. 43 through No. 57	$10d_b$		

^[1]A standard hook for deformed bars in tension includes the specific inside bend diameter and straight extension length. It shall be permitted to use a longer straight extension at the end of a hook. A longer extension shall not be considered to increase the anchorage capacity of the hook.

Standard Hooks and Anchorage

- ◆ Bend diameters for bars used as transverse reinforcement and standard hooks for bars used to anchor stirrups, ties, hoops, and spirals

Table 25.3.2—Minimum inside bend diameters and standard hook geometry for stirrups, ties, and hoops

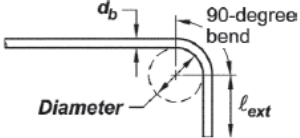
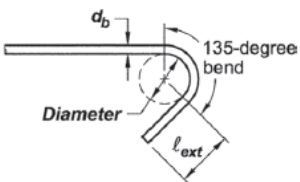
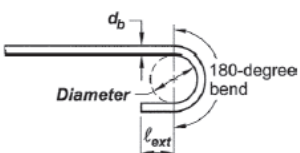
Type of standard hook	Bar size	Minimum inside bend diameter, mm	Straight extension ^[1] ℓ_{ext} mm	Type of standard hook
90-degree hook	No. 10 through No. 16	$4d_b$	Greater of $6d_b$ and 75 mm	
	No. 19 through No. 25	$6d_b$	$12d_b$	
135-degree hook	No. 10 through No. 16	$4d_b$	Greater of $6d_b$ and 75 mm	
	No. 19 through No. 25	$6d_b$		
180-degree hook	No. 10 through No. 16	$4d_b$	Greater of $4d_b$ and 65 mm	
	No. 19 through No. 25	$6d_b$		

^[1]A standard hook for stirrups, ties, and hoops includes the specific inside bend diameter and straight extension length. It shall be permitted to use a longer straight extension at the end of a hook. A longer extension shall not be considered to increase the anchorage capacity of the hook.

Standard Hooks and Anchorage

- ◇ Development length of Hooked bars (l_{dh})
 - ◇ Development length l_{dh} for deformed bars in tension terminating in a standard hook shall be the greater of

$$l_{dh} = \max \left\{ \begin{array}{l} \left(\frac{f_y \psi_e \psi_r \psi_o \psi_c}{23 \lambda \sqrt{f'_c}} \right) d_b^{1.5} \\ 8 d_b \\ 150 \text{ mm} \end{array} \right.$$

Table 25.4.3.2—Modification factors for development of hooked bars in tension

Modification factor	Condition	Value of factor
Lightweight λ	Lightweight concrete	0.75
	Normalweight concrete	1.0
Epoxy ψ_e	Epoxy-coated or zinc and epoxy dual-coated reinforcement	1.2
	Uncoated or zinc-coated (galvanized) reinforcement	1.0
Confining reinforcement ψ_r	For No. 36 and smaller bars with $A_{th} \geq 0.4A_{hs}$ or $s^{[1]} \geq 6d_b^{[2]}$	1.0
	Other	1.6
Location ψ_o	For No. 36 and smaller diameter hooked bars: (1) Terminating inside column core with side cover normal to plane of hook ≥ 65 mm, or (2) With side cover normal to plane of hook $\geq 6d_b$	1.0
	Other	1.25
Concrete strength ψ_c	For $f'_c < 42$ MPa	$f'_c/105 + 0.6$
	For $f'_c \geq 42$ MPa	1.0

^[1] s is minimum center-to-center spacing of hooked bars.

^[2] d_b is nominal diameter of hooked bar.

Standard Hooks and Anchorage

- ◆ Development length of Hooked bars (l_{dh})
 - ◆ The total cross-sectional area of ties or stirrups confining hooked bars A_{th} shall consist of:
 - ◆ Standard Ties or stirrups that enclose the hook
 - ◆ OR Other reinforcement enclosing the hook, that extends at least $0.75l_{dh}$ from the enclosed hook in the direction of the bar in tension
 - ◆ For bars being developed by a standard hook at discontinuous ends of members with both side cover and top (or bottom) cover to hook less than 65 mm
 - ◆ The hook shall be enclosed along l_{dh} within ties or stirrups perpendicular to l_{dh} at $s \leq 3d_b$
 - ◆ The first tie or stirrup shall enclose the bent portion of the hook within $2d_b$ of the outside of the bend

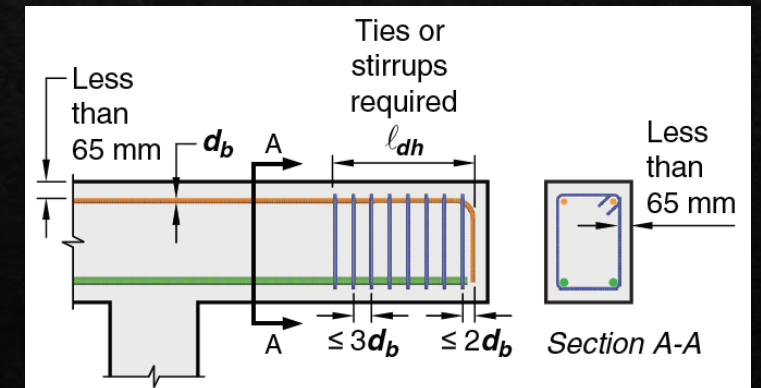
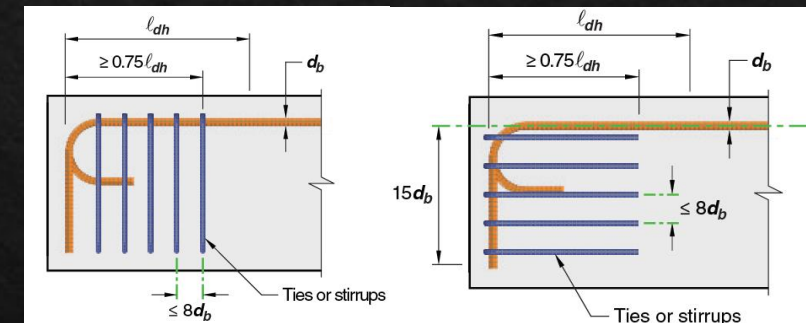

Lap Splices

- ◆ In some cases, we encounter a situation where we need to cut reinforcement while it still in tension (Very long beam)
- ◆ In this case, the required Tension lap splice length ℓ_{st}

Table 25.5.2.1—Lap splice lengths of deformed bars and deformed wires in tension

$A_{s,provided}/A_{s,required}^{[1]}$ over length of splice	Maximum percent of A_s spliced within required lap length	Splice type	ℓ_{st}	
≥ 2.0	50	Class A	Greater of:	$1.0\ell_d$ and 300 mm
	100	Class B	Greater of:	$1.3\ell_d$ and 300 mm
< 2.0	All cases	Class B	Greater of:	$1.3\ell_d$ and 300 mm

^[1]Ratio of area of reinforcement provided to area of reinforcement required by analysis at splice location.

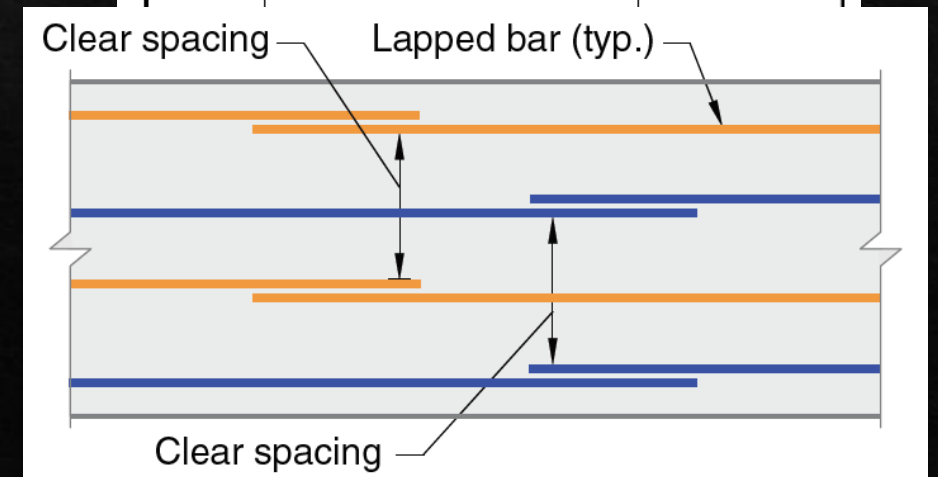
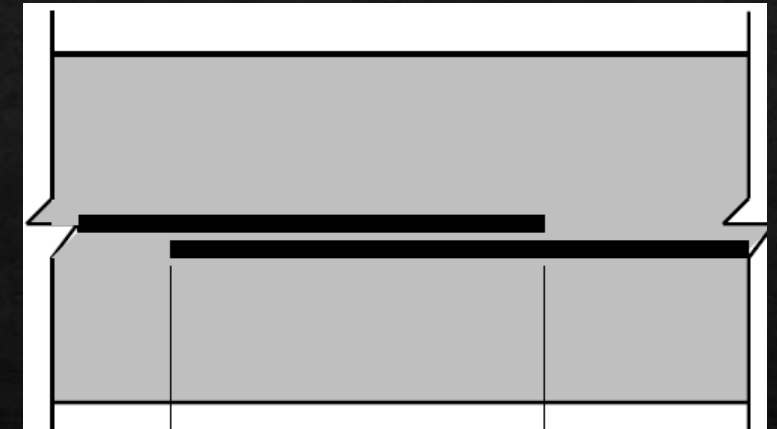

Example:

- ◆ Calculate the length of all bars and draw side view the beam reinforcement

$$f_y = 420 \text{ MPa}$$
$$f'_c = 28 \text{ MPa}$$

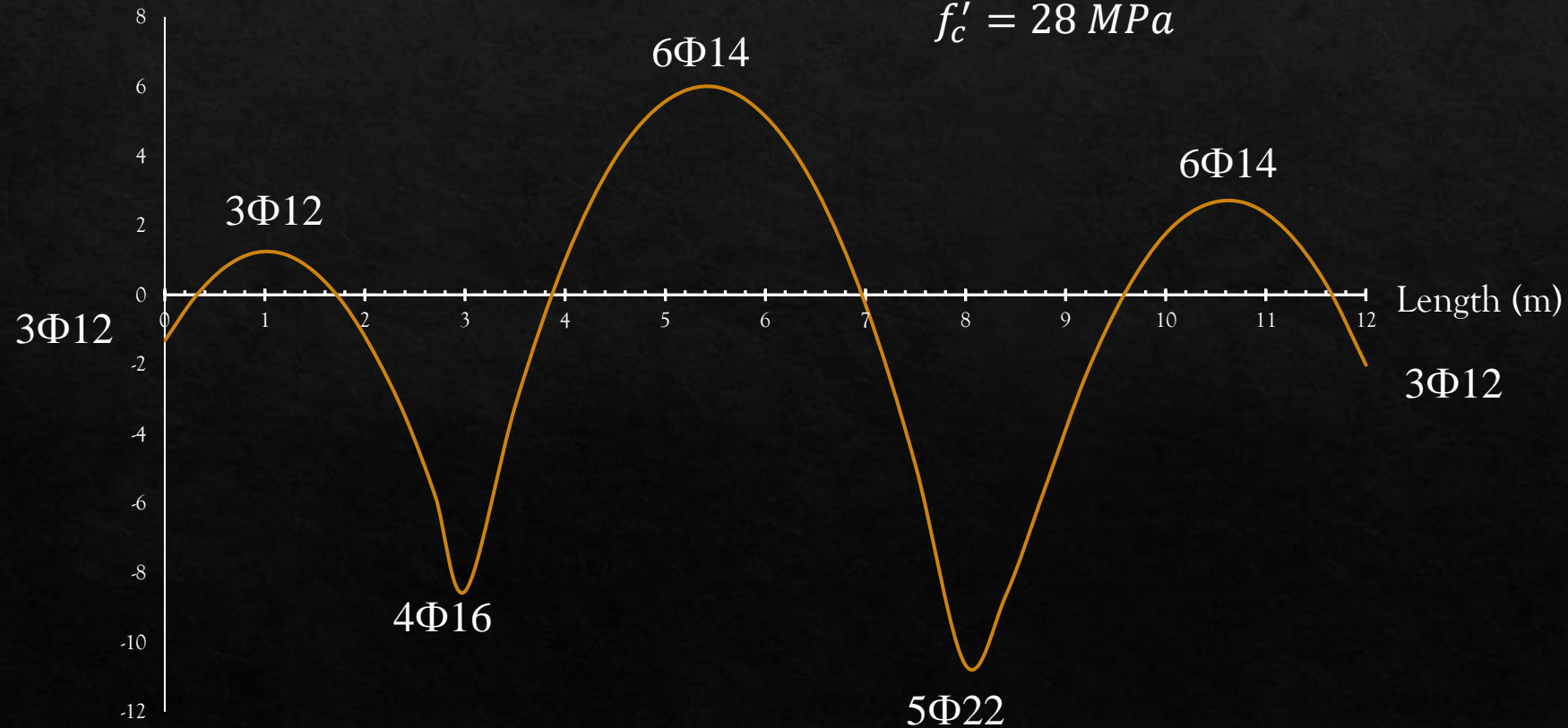

Example:

- ◇ Calculate the length of all bars and draw side view the beam reinforcement

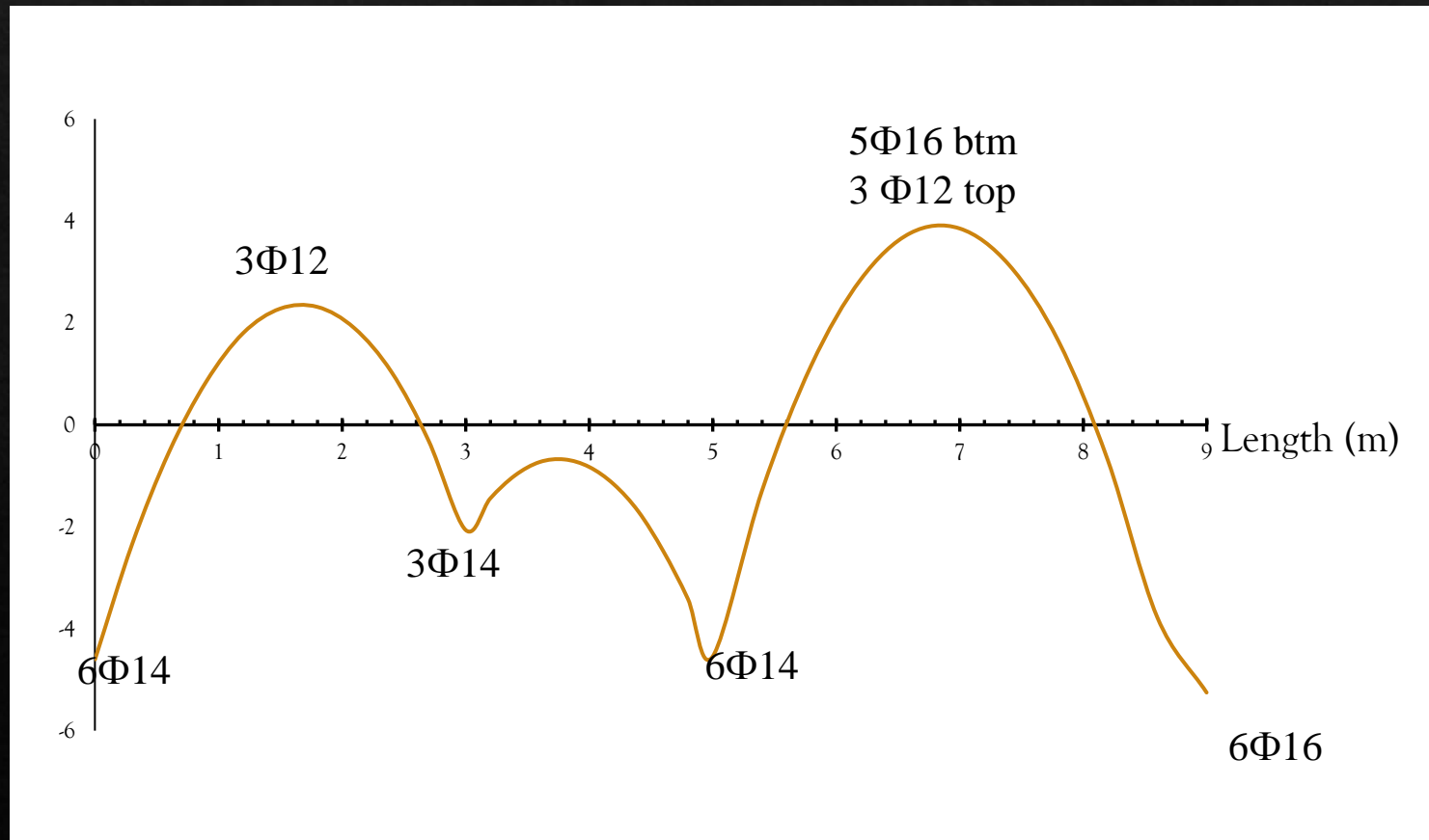

$$f_y = 420 \text{ MPa}$$

$$f'_c = 28 \text{ MPa}$$