



Dr. Khalil Qatu

ENCE 331: Introduction

Soil Mechanics

- Theoretically or experimentally studying the behavior of soil under the action of ;
 1. Loads (static or dynamic),
 2. Gravitational forces,
 3. Water and,
 4. Temperature.
- According to **Karl Terzaghi**, Soil Mechanics is the applications of **Laws of Hydraulics** and **Mechanics** to engineering problem dealing with sediments and other unconsolidated accumulations of solid particles produced by Mechanical and Chemical Disintegration of rocks.

WHY Soil Mechanics ??

- Virtually every structure is supported by soil or rock. Those that aren't either fly, float or fall over.
- Various reasons to study the properties of Soil:
 - Foundation to support Structures and Embankments
 - Construction Material
 - Slopes and Landslides
 - Earth Retaining Structures
 - Special Problems

WHY Soil Mechanics ??

1. Foundation to support Structures and Embankments

- Effects of static loading on soil mass
 - Shear failure of the foundation soil
 - Settlement of structures
- Stability criteria (Solution)
 - There should be no shear failure of the foundation soil.
 - The settlement should remain within permissible limits.
- Firm Soil -> Spread Footing (Spread Foundation)
- Soft Soil -> Pile Foundation (Vertical members transferring load of structure to ground i.e. rock)



WHY Soil Mechanics ??

1. Foundation to support Structures and Embankments

- Effects of dynamic loading on soil mass
 - Compaction Characteristics
 - Moisture Variation



Soil subjected to dynamic load.

WHY Soil Mechanics ??

2. Construction Material

- Subgrade of highway pavement
- Land reclamation (Dubai Palm City)
- Earthen dam

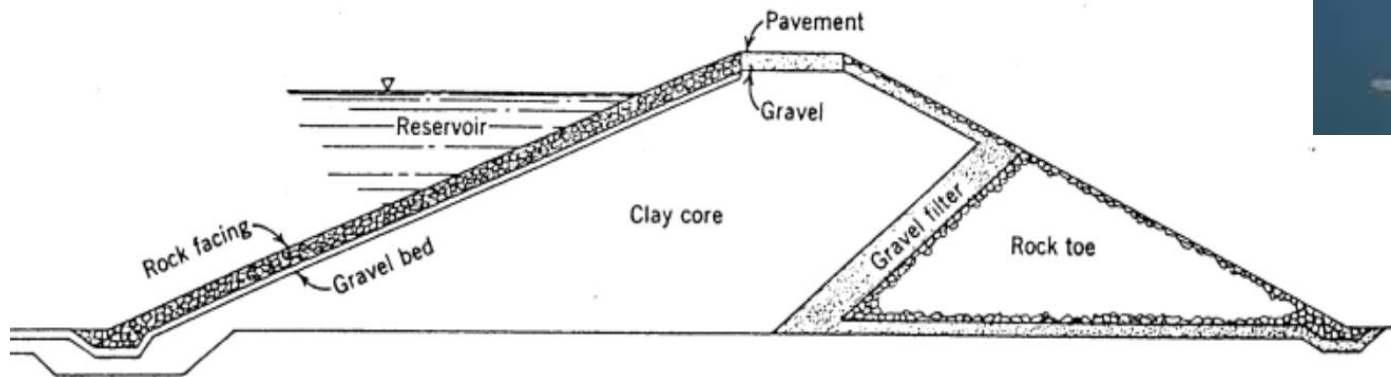

WHY Soil Mechanics ??

3. Slopes and Landslides

- Major cause is the moisture variation resulting in;
 - Reduction of shear strength
 - Increase of moisture
 - Increase in unit weight
- Excavation of trenches for buildings require braced excavation.



Dr. Khalil M. Qatu



WHY Soil Mechanics ??

4. Earth Retaining Structures

- Earth retaining structure (e.g., Retaining walls) are constructed to retain (holds back) any material (usually earth) and prevents it from sliding or eroding away.

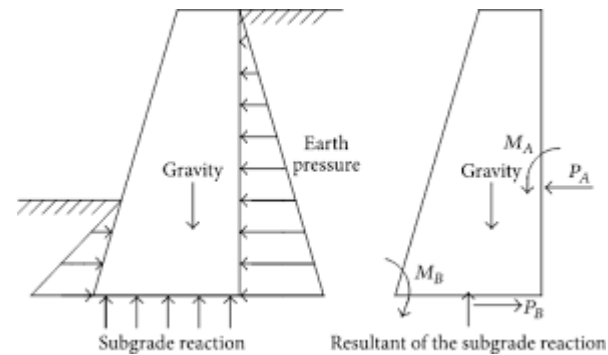
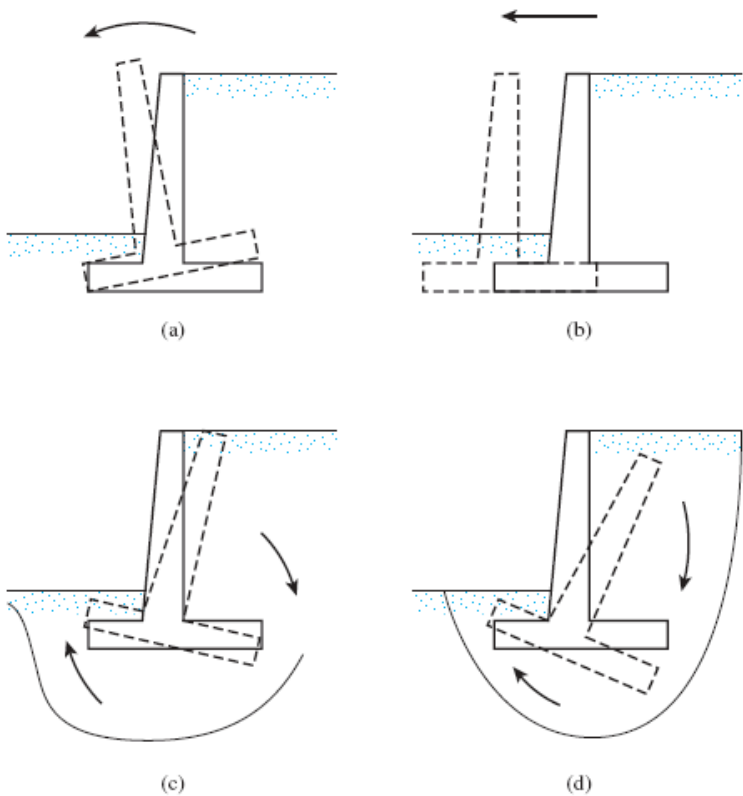

What is soil??

- Soil is defined as the uncemented aggregate of mineral grains and decayed organic material (solid particle) with liquid and gas in the empty spaces between the solid particles

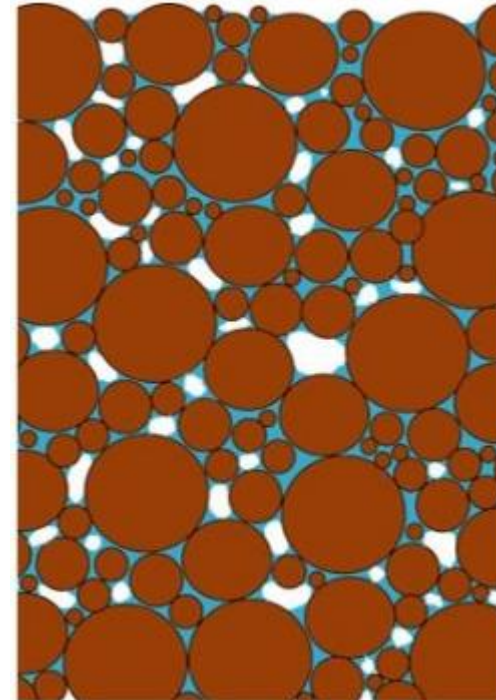

Origin of soil

- Soil Forms due to weathering of rocks
 - The physical properties of soil are dictated primarily by the minerals that constitute the soil particles and, hence, the rock from which it is derived.

Types of weathering:

- Physical weathering
- Chemical weathering

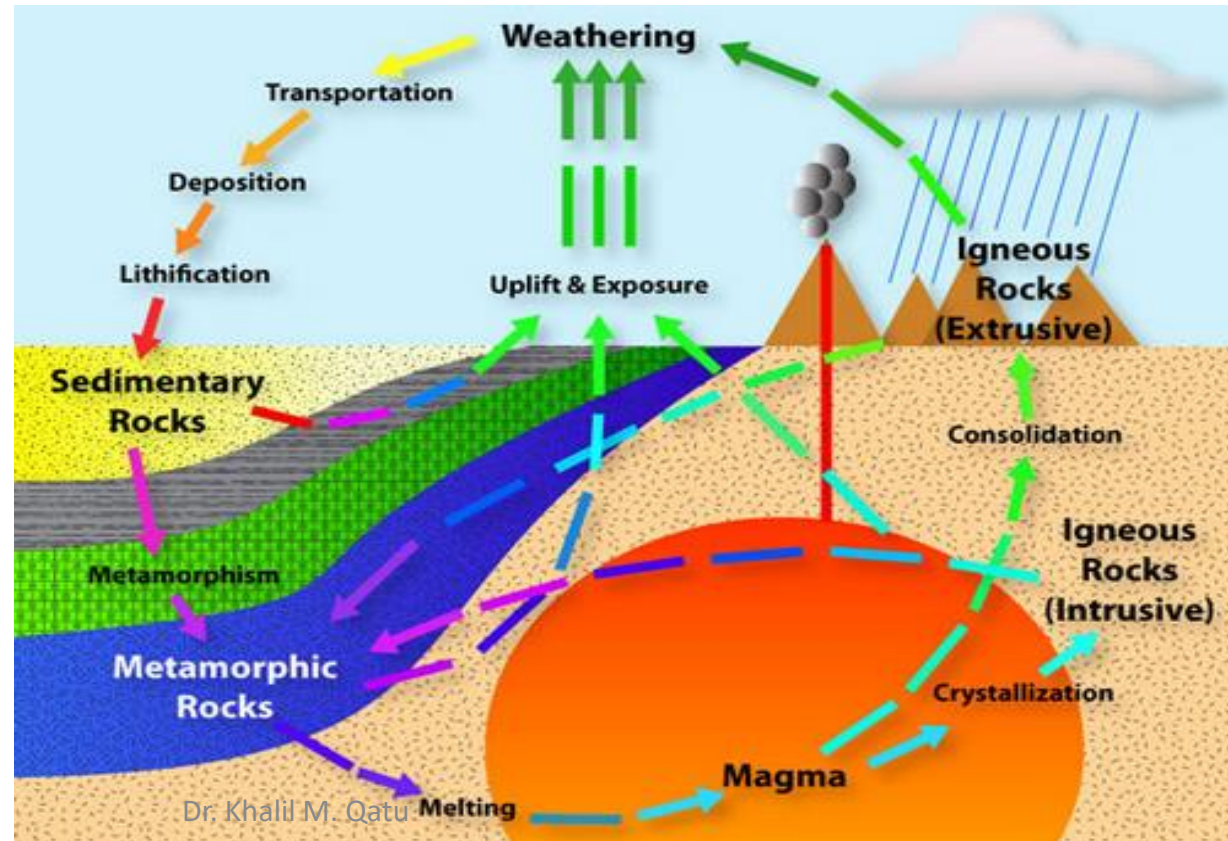

Origin of soil

- Physical weathering (Mechanical):
 - disintegration of rocks into smaller particles through physical processes

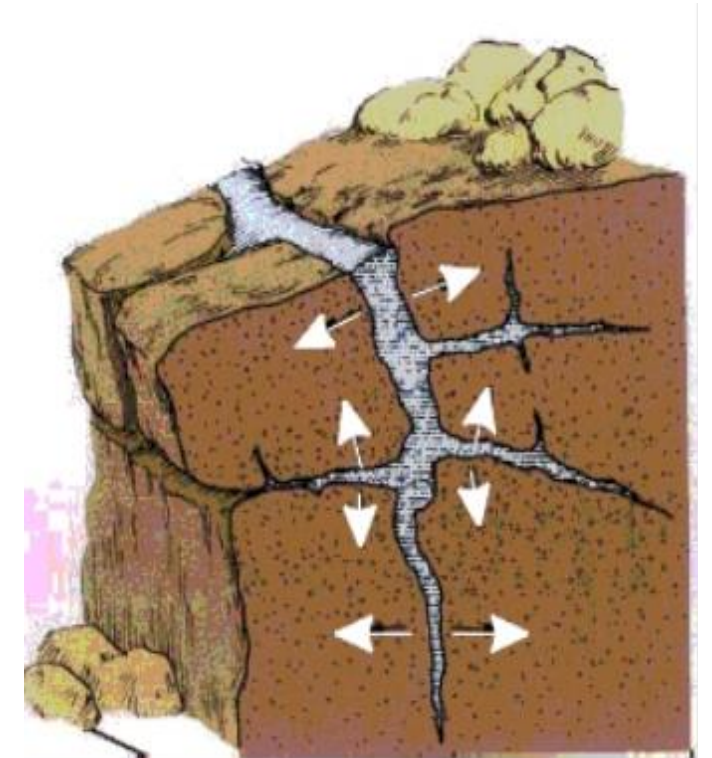
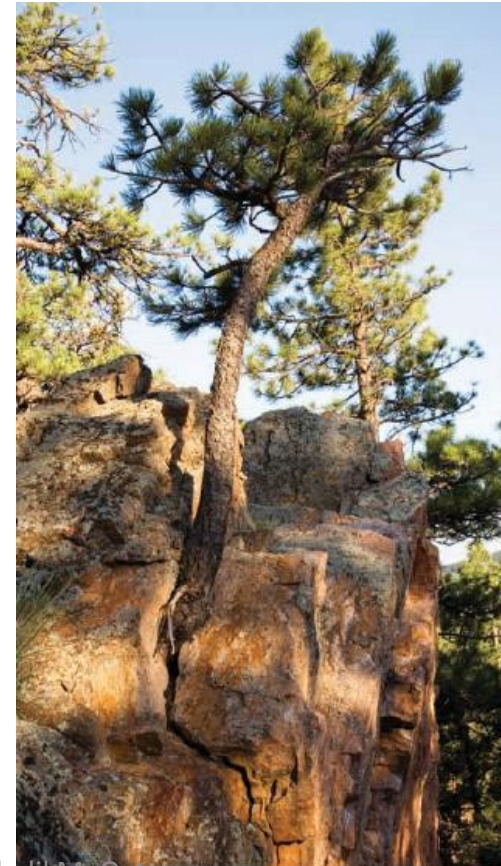
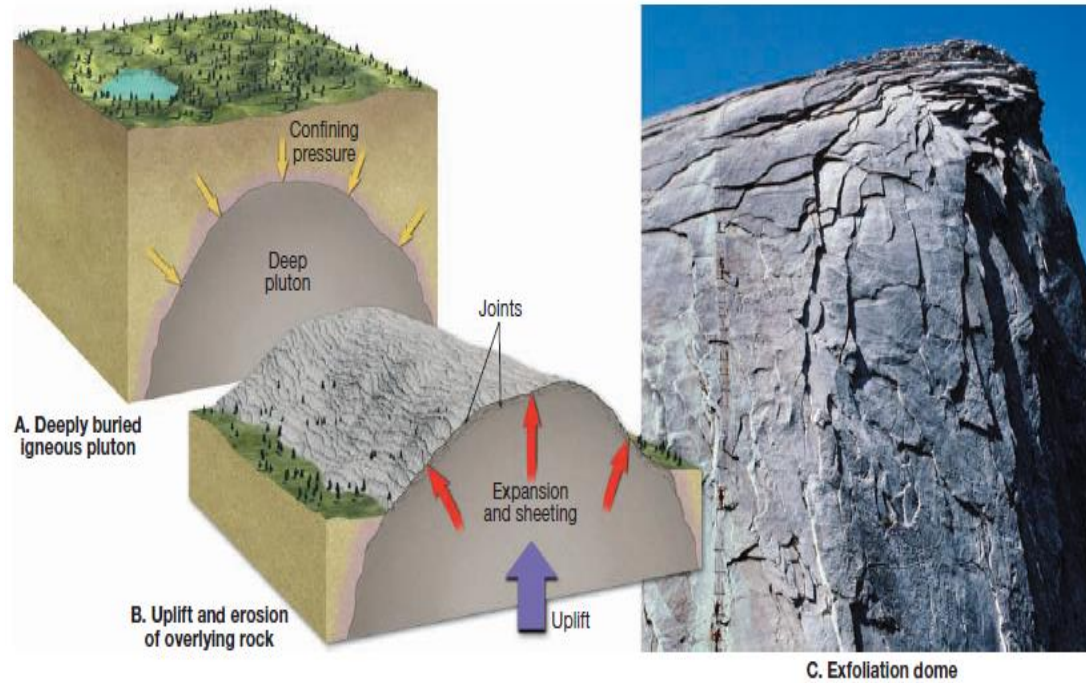

Origin of soil

- Chemical weathering

- disintegration of rock through chemical reactions between the minerals in the rocks, water, and oxygen in the atmosphere.

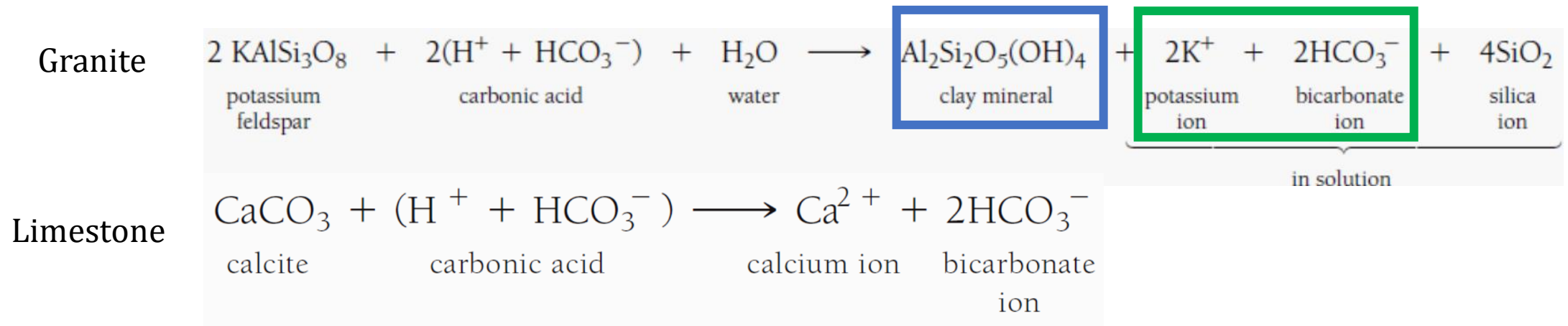

Soil formation

- Because soil processes take place at the surface downwards, there are variations in composition, texture, structure, & color that develop with depth.
- With time, these differences become more pronounced & divide the soil into layers or zones known as horizons.
- When digging into soil, the vertical section through the horizons constitutes the **Soil Profile**.

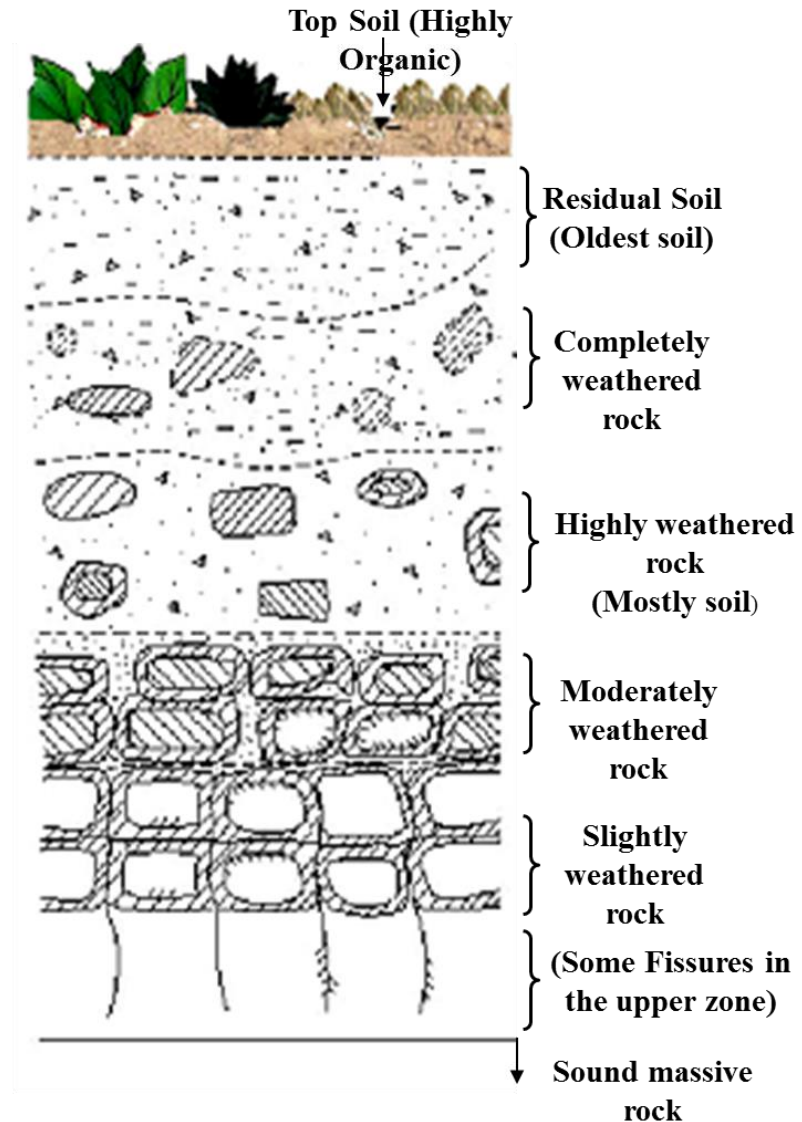

Soil types

- **Geological view**

- Residual Soils:

- When the rock weathering is faster than the transport process induced by water, wind and gravity, much of the soil remains in place.

- Transported Soils:

- Glacial Soils: developed, transported and deposited by the actions of glaciers.
 - Alluvial Soils: transported and deposited to their present position by streams and rivers.
 - Aeolian Soil: transported deposited by wind.
 - Colluvial Soil: transported downslope by gravity. There are two types of downslope movement – slow (creep – mm/yr) and rapid (e.g., landslide).
 - Lacustrine and Marine Soil: Lacustrine Soil is deposited beneath the lakes. Marine Soil is also deposited underwater i.e., in the Ocean.

Soil types

- **Engineering view**

- **Gravel**: pieces of rocks with occasional particles of quartz, feldspar, and other minerals
- **Sand**: particles are made of mostly quartz and feldspar
- **Silt**: microscopic soil fractions that consist of very fine quartz grains and some flake-shaped particles that are fragments of micaceous minerals.
- **Clay**: flake-shaped microscopic and submicroscopic particles of mica, clay minerals, and other minerals.

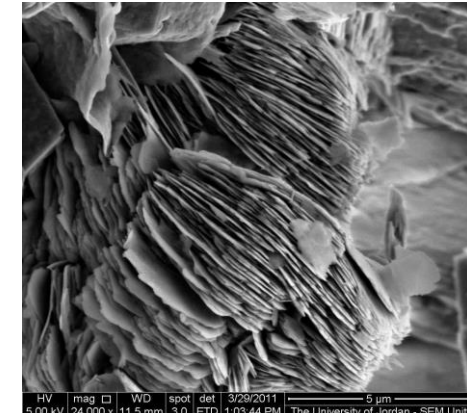
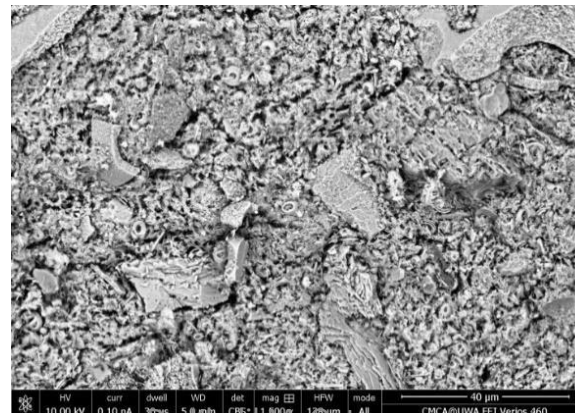
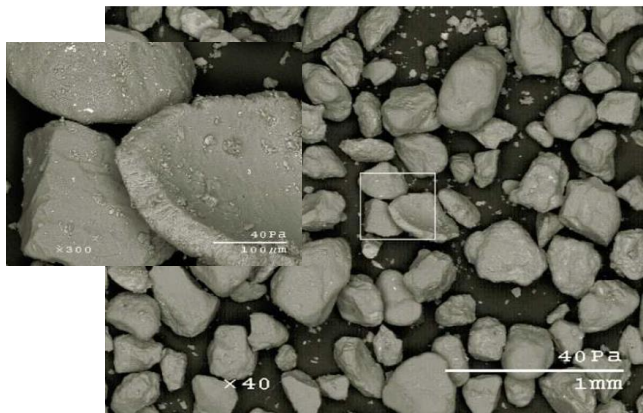

Soil types

- **Engineering view**

- Clay Minerals: complex aluminum silicates composed of two basic units:
 1. Silica tetrahedron
 2. Alumina octahedron.

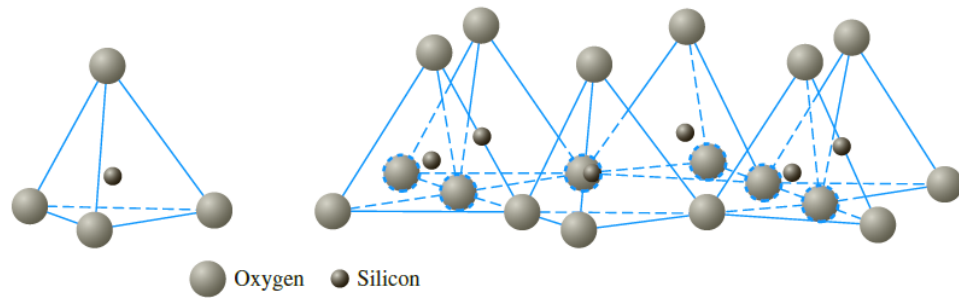

Silica

Silica sheet

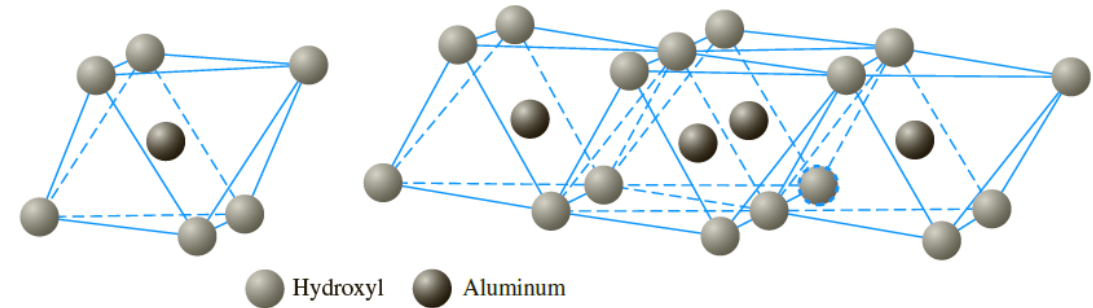

Alumina octahedron

Gibbsite sheet

Soil types

- **Engineering view**

- Clay Minerals:

- **Kaolinite**: repeating layers of elemental silica-gibbsite sheets in a 1:1 lattice (The surface area of the kaolinite particles per unit mass is about $15 \text{ m}^2/\text{g}$, i.e. Specific surface).
 - **Illite**: gibbsite sheet bonded to two silica sheets - one at the top and at the bottom, layers are bonded by potassium ions. (specific surface $80 \text{ m}^2/\text{g}$)
 - **Montmorillonite**: gibbsite sheet bonded to two silica sheets - one at the top and another at the bottom, large amount of water is attracted into the space between the layers. (specific surface $800 \text{ m}^2/\text{g}$)

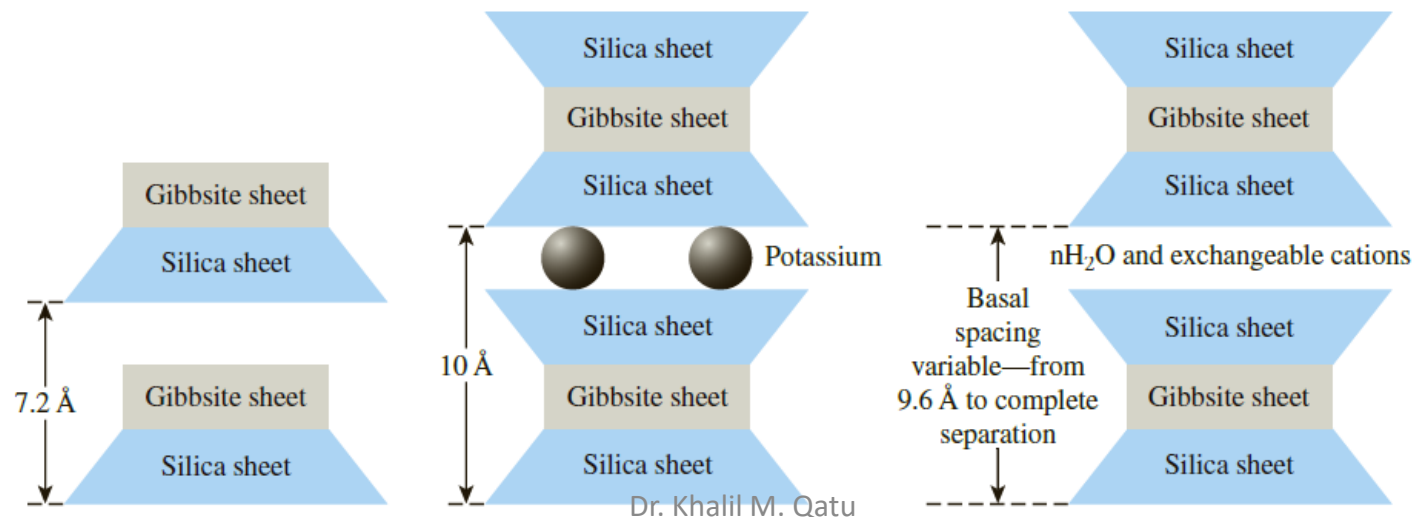

Soil types

- **Engineering view**

- Clay Minerals:

When water is added to clay, cations and a few anions float around the clay particles. This configuration is referred to as a *diffuse double layer*. The cation concentration decreases with the distance from the surface of the particle

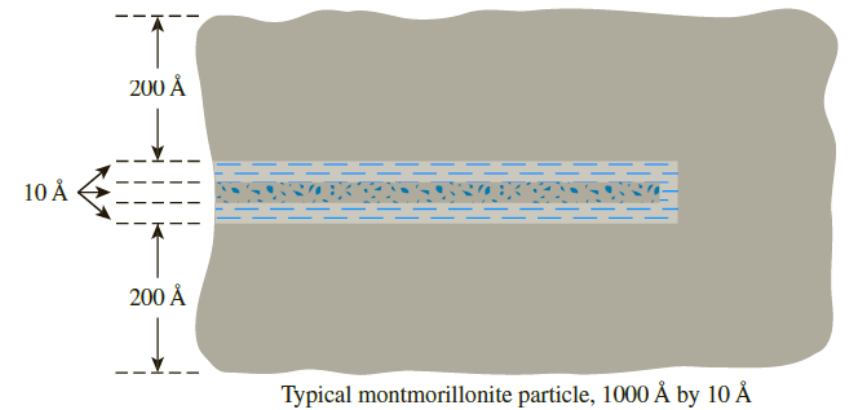
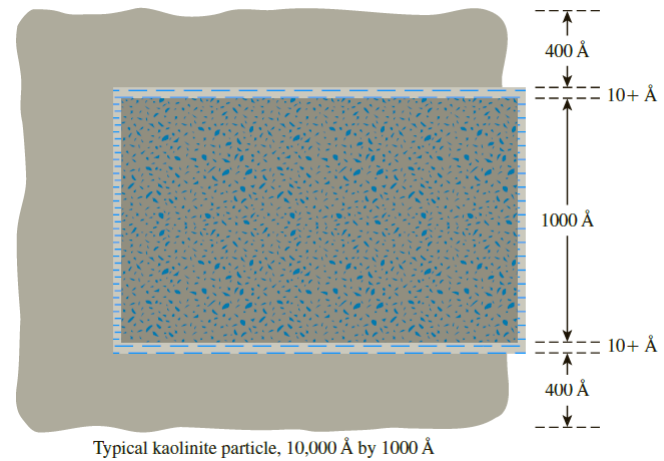
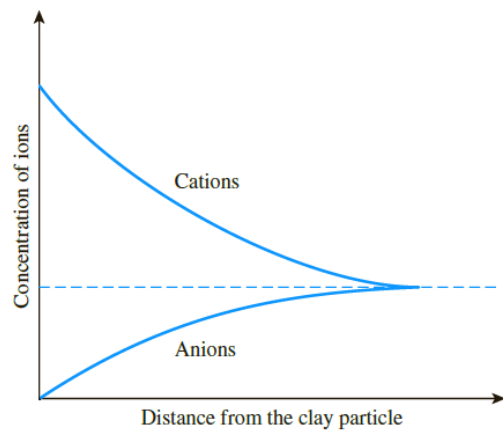
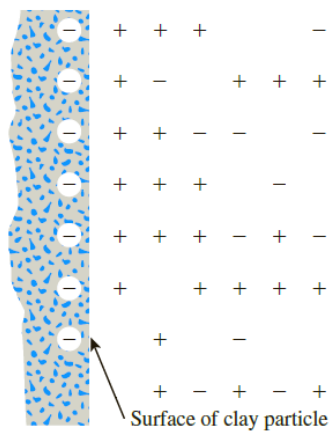

Soil types

- **Engineering view**

Name of organization	Grain size (mm)			
	Gravel	Sand	Silt	Clay
Massachusetts Institute of Technology (MIT)	>2	2 to 0.06	0.06 to 0.002	<0.002
U.S. Department of Agriculture (USDA)	>2	2 to 0.05	0.05 to 0.002	<0.002
American Association of State Highway and Transportation Officials (AASHTO)	76.2 to 2	2 to 0.075	0.075 to 0.002	<0.002
Unified Soil Classification System (U.S. Army Corps of Engineers, U.S. Bureau of Reclamation, and American Society for Testing and Materials)	76.2 to 4.75	4.75 to 0.075	Fines (i.e., silts and clays) <0.075	

Mechanical Analysis of soil

Determination of the size range of particles present in a soil, expressed as a percentage of the total dry weight

- **Sieve analysis**: Particles larger than 0.075 mm
- **Hydrometer analysis**: Particles smaller than 0.075 mm

After this analysis is performed, engineers draw the **Grain size distribution** for the soil.

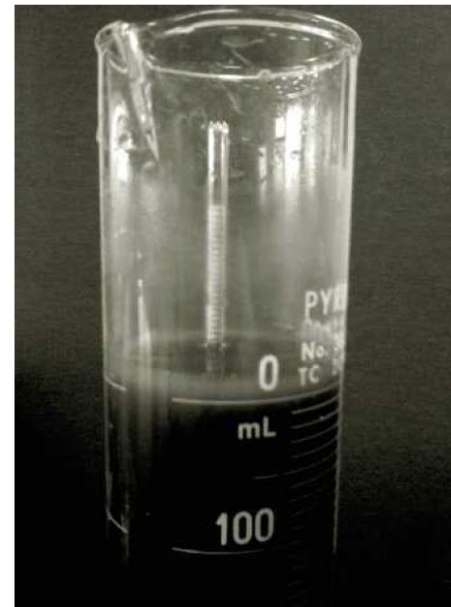
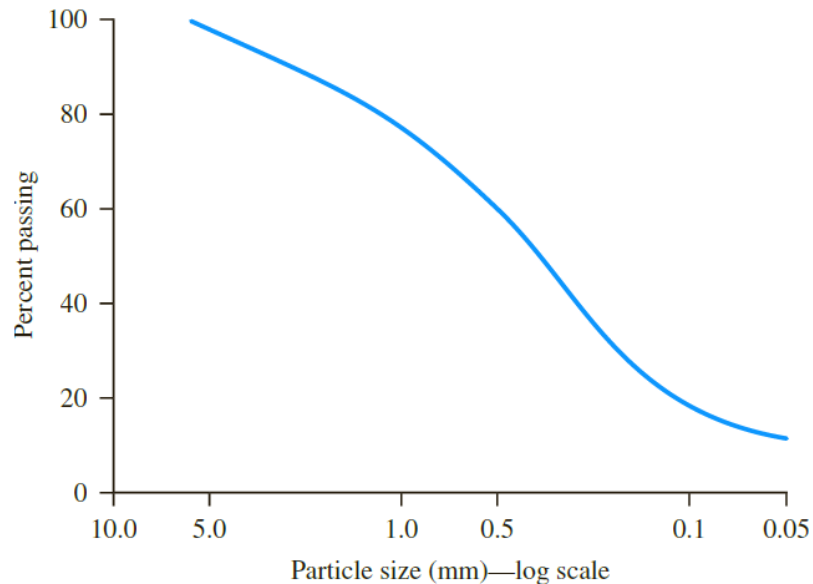

Mechanical Analysis of soil

- **Sieve analysis:** is conducted by
 - Taking a measured amount of dry, well-pulverized soil
 - Passing it through a stack of progressively finer sieves with a pan at the bottom.
 - The amount of soil retained on each sieve is measured,
 - The cumulative percentage of soil passing through each is determined. This percentage is generally referred to as percent finer.

Sieve no.	Opening (mm)	Sieve no.	Opening (mm)
4	4.75	45	0.355
5	4.00	50	0.300
6	3.35	60	0.250
7	2.80	70	0.212
8	2.36	80	0.180
10	2.00	100	0.150
12	1.70	120	0.125
14	1.40	140	0.106
16	1.18	170	0.090
18	1.00	200	0.075
20	0.85	230	0.063
25	0.71	270	0.053
30	0.60	325	0.045
35	0.500	400	0.038
40	0.425		

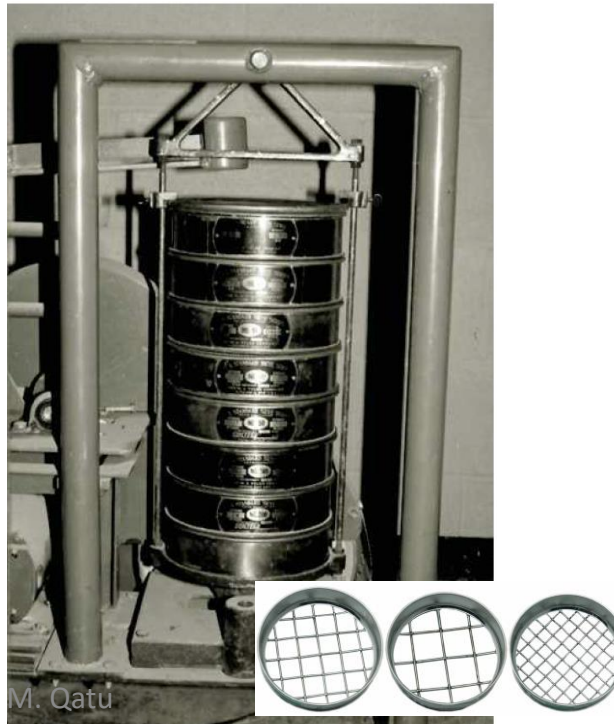

Mechanical Analysis of soil

- **Sieve analysis:**

- **Example:** given the results of sieve analysis test
 - What is the total weight of the soil sample
 - Draw a grain size distribution curve

U.S. sieve no.	Mass of soil retained on each sieve (g)
4	0
10	21.6
20	49.5
40	102.6
60	89.1
100	95.6
200	60.4
Pan	31.2

Mechanical Analysis of soil

- **Hydrometer analysis:** is based on the principle of sedimentation of soil grains in water. When a soil specimen is dispersed in water, the particles settle at different velocities, depending on their shape, size, weight, and the viscosity of the water.
 - it is assumed that all the soil particles are spheres and that the velocity of soil particles can be expressed by Stokes' law

$$v = \frac{\rho_s - \rho_w}{18\eta} D^2 \quad \longrightarrow \quad D = \sqrt{\frac{30\eta}{(G_s - 1)\rho_w}} \sqrt{\frac{L}{t}}$$

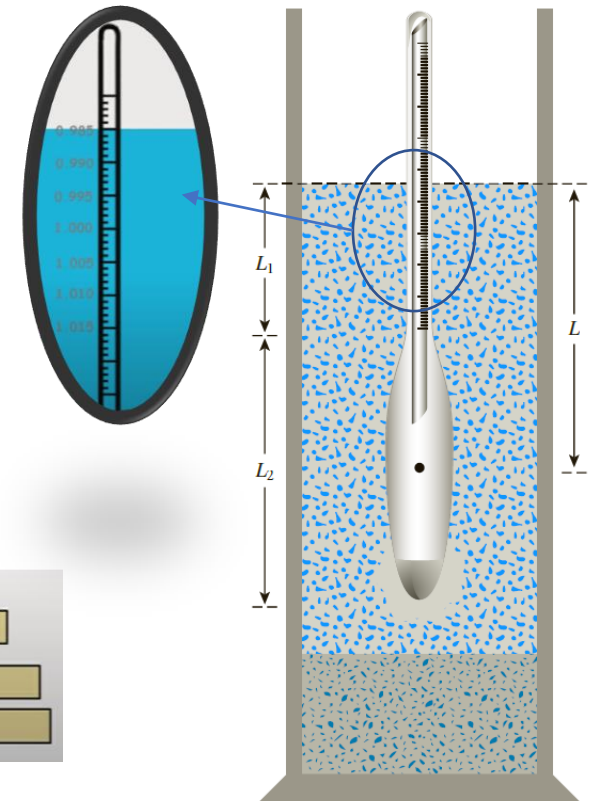
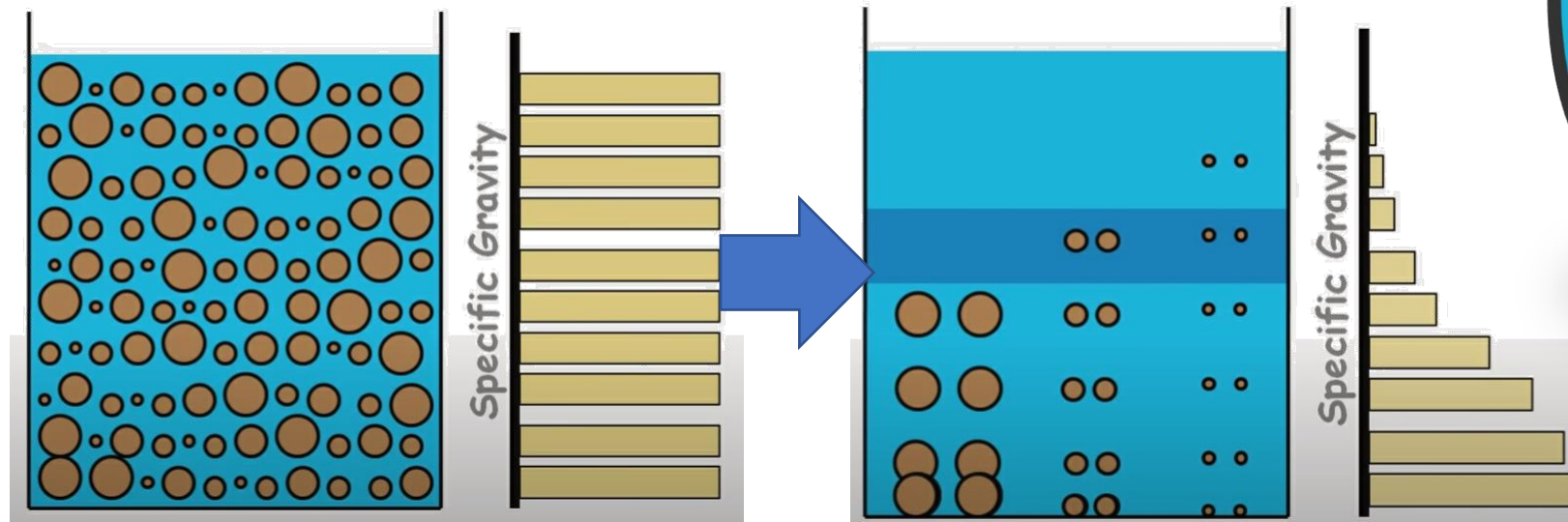

Mechanical Analysis of soil

- Hydrometer analysis:

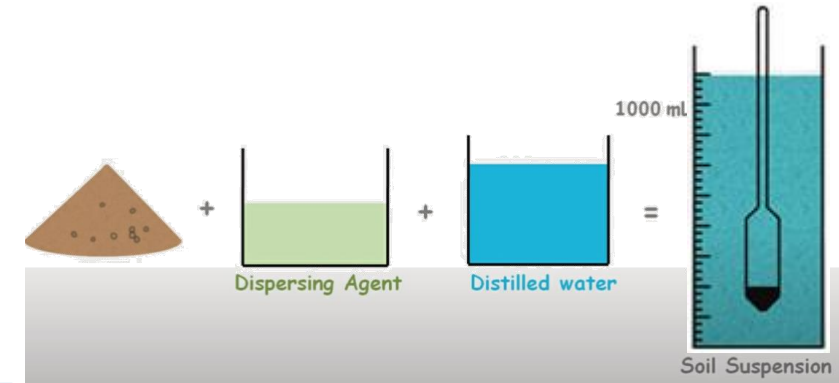

	time	R_h
1	30 seconds	---
2	1 minute	---
3	2 minutes	---
4	4 minutes	---
5	8 minutes	---
6	15 minutes	---
7	30 minutes	---
8	1 hour	---
9	2 hours	---
10	4 hours	---
11	8 hours	---
12	24 hours	---

Hydrometer reading, R	L (cm)	Hydrometer reading, R	L (cm)
0	16.3	31	11.2
1	16.1	32	11.1
2	16.0	33	10.9
3	15.8	34	10.7
4	15.6	35	10.6
5	15.5	36	10.4
6	15.3	37	10.2
7	15.2	38	10.1
8	15.0	39	9.9
9	14.8	40	9.7
10	14.7	41	9.6
11	14.5	42	9.4
12	14.3	43	9.2
13	14.2	44	9.1
14	14.0	45	8.9
15	13.8	46	8.8
16	13.7	47	8.6
17	13.5	48	8.4
18	13.3	49	8.3
19	13.2	50	8.1
20	13.0	51	7.9
21	12.9	52	7.8
22	12.7	53	7.6
23	12.5	54	7.4
24	12.4	55	7.3
25	12.2	56	7.1
26	12.0	57	7.0
27	11.9	58	6.8
28	11.7	59	6.6
29	11.5	60	6.5

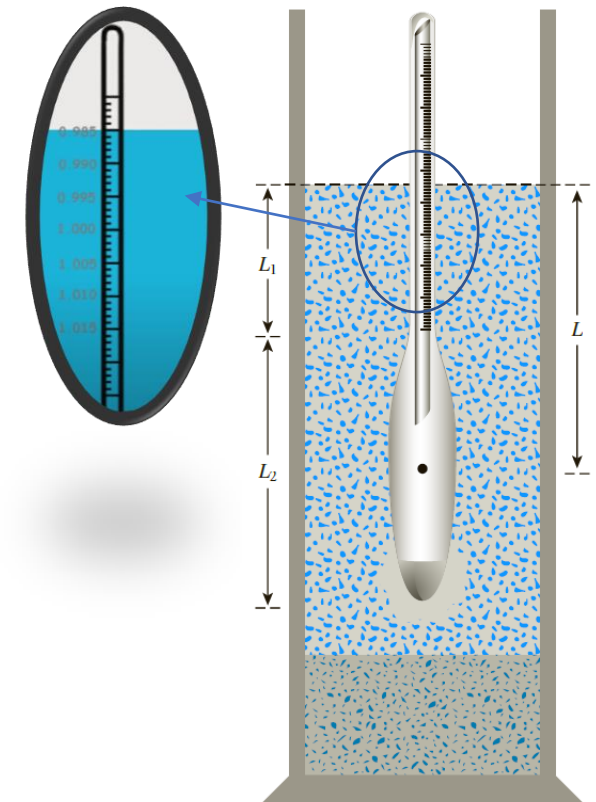

Mechanical Analysis of soil

• Hydrometer analysis: Corrections

- Meniscus correction: always positive (lower reading than correct)
- Dispersing agent correction: dispersing agent increases density \uparrow - Reading \uparrow - Correction \downarrow (always negative)
- Temperature correction: hydrometer is calibrated at 27°C. Temp \uparrow - Density \downarrow - Reading \downarrow - Correction \uparrow (+ve)
Temp \downarrow - Density \uparrow - Reading \uparrow - Correction \downarrow (-ve)

$$\% \text{finer} = \left(\frac{G_s}{G_s - 1} \right) \frac{R}{W_{\text{sample}}} * 100\%$$

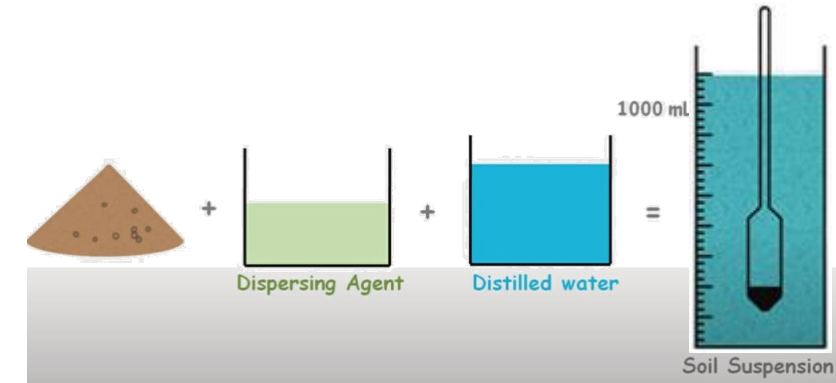
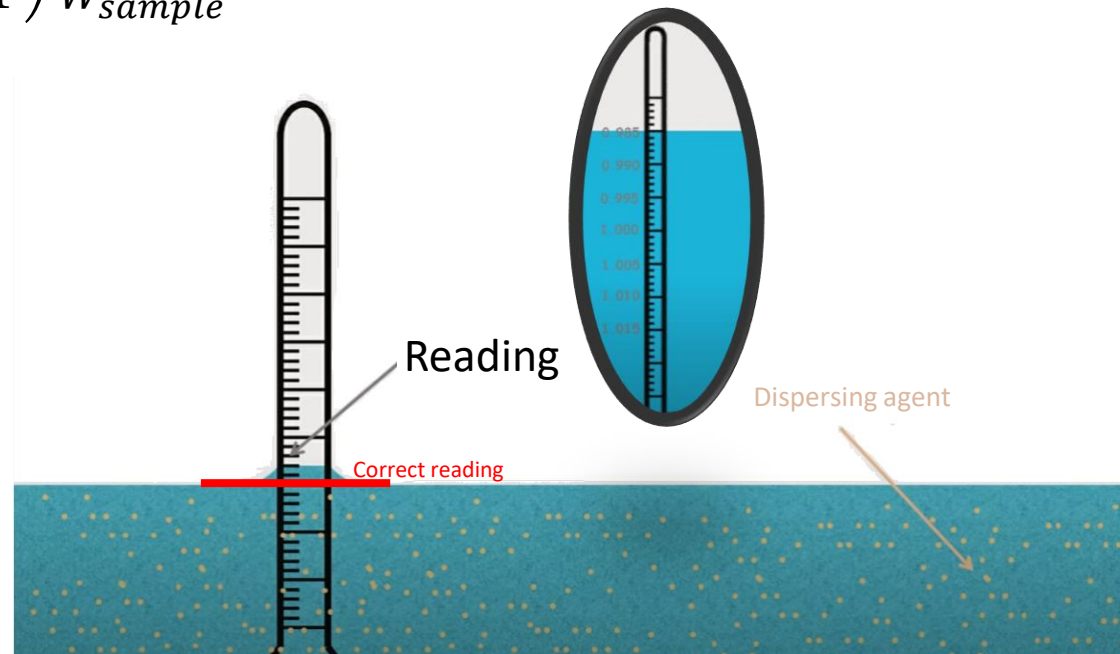

	time	R_h
1	30 seconds	---
2	1 minute	---
3	2 minutes	---
4	4 minutes	---
5	8 minutes	---
6	15 minutes	---
7	30 minutes	---
8	1 hour	---
9	2 hours	---
10	4 hours	---
11	8 hours	---
12	24 hours	---

Mechanical Analysis of soil

- **Particle size distribution curve (Gradation curve)**

Calculations are plotted on semilogarithmic graph paper with percent finer as the ordinate (arithmetic scale) and sieve opening size as the abscissa (logarithmic scale).

- Effective size (D_{10}): the diameter in the particle-size distribution curve corresponding to 10% finer. The effective size of a granular soil is a good measure to estimate the hydraulic conductivity and drainage through soil.

- Uniformity coefficient (C_u): This parameter is defined as

$$C_u = \frac{D_{60}}{D_{10}}$$

- Coefficient of gradation (C_c): This parameter is defined as

$$C_c = \frac{(D_{30})^2}{D_{60} D_{10}}$$

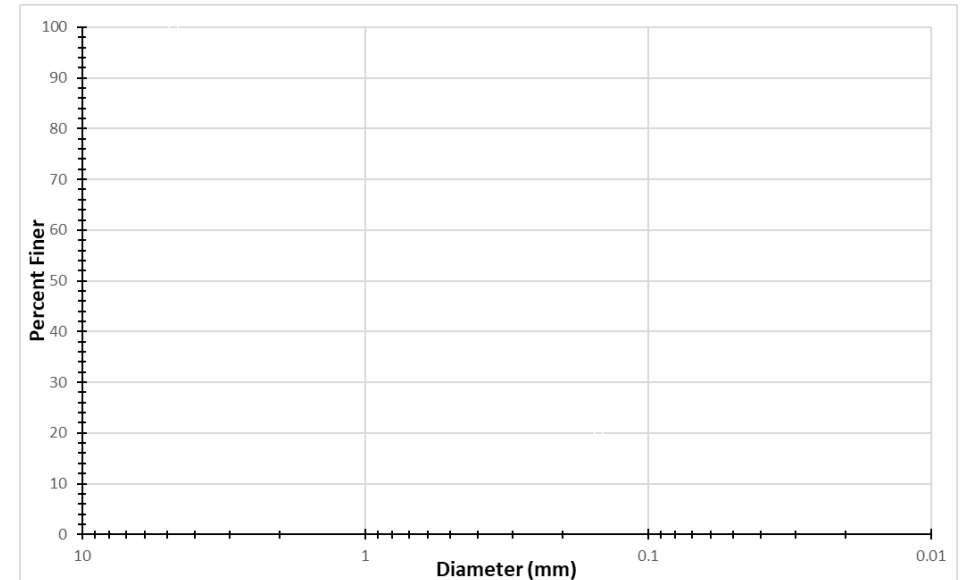

Mechanical Analysis of soil

- **Particle size distribution curve (Gradation curve)**

Example:

Following are the results of a sieve analysis and a hydrometer analysis on a given soil.

- Plot a combined grain-size distribution curve.
- Find the effective diameter, coefficient of gradation, and uniformity coefficient.
- Determine the percent of gravel, sand, silt, and clay based on the ASSHTO Classification System

Sieve Analysis

U.S. sieve no.	Sieve opening (mm)	Percent passing
4	4.75	100
10	2.0	92
20	0.850	80
30	0.600	75
40	0.425	68
60	0.250	62
100	0.106	43
200	0.075	31

Hydrometer Analysis

Grain diameter (mm)	Percent finer
0.08	38
0.05	31
0.025	21
0.013	16
0.004	11
0.0017	9