

1

Introduction to Lab View

1. Objective

Increasing familiarity and experimenting with Lab- View by implementing different systems by using Lab-View, and by trying different components in it.

2. Overview

LabVIEW (Laboratory Virtual Instrument Engineering Workbench) is a graphical programming environment. So it relies on graphical components to implement different systems and different programming scripts. There are many applications use the Lab-View in different fields: science, education and industry. In this Experiment, the students will write programs to become familiar with some of the basics of LabView.

3. Procedure

3.1 Design a Simple Alarm System:

We need to design a control system with the following specifications:

- 1-The system has two inputs: pressure and temperature.
- 2-There is an alarm when the temperature exceeds 100°C or the pressure exceeds 15KPa .
- 3-The transfer function of the temperature and pressure transducers are $3.2\text{mV}/^{\circ}\text{C}$, $0.3\text{V}/\text{KPa}$ respectively .

This example is very simple, try to draw a simple design before starting with LabView, and try to recognize the required components of the system.

The following steps describe how to assemble a VI that implements Simple Alarm System. When this VI is completed, you will be able to test the functionality of the system. Inspect Figure (3.1) and Figure (3.2) which represent the front panel and block diagram of the system.



Figure (3.1): Simple Alarm System VI Front Panel

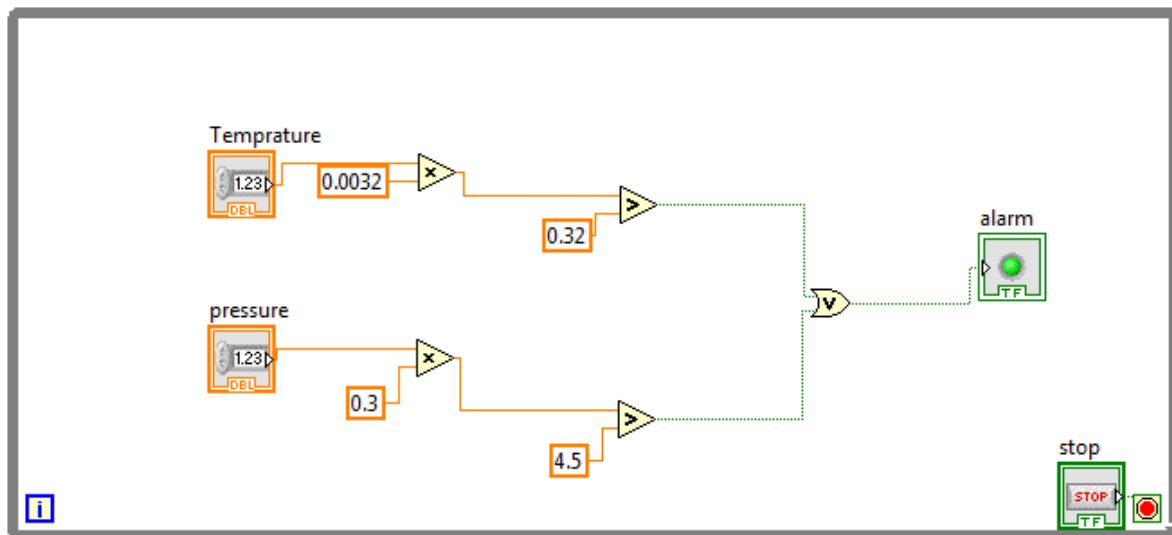
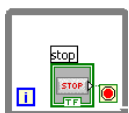

Figure (3.2): Simple Alarm System VI Block Diagram

The block diagram consists of a while loop which contains the components that change their values while the program is running.

To find any component in the LABVIEW , simply make a right click , the you can search on it .Also to find the components of this system , you can follow these steps.



1. On the block diagram, choose from the Functions palette>Express>Exec Control>while loop. Expand the while loop block to proper size. Note that a stop button will appear on the front panel which stops the execution of the whole VI

when pressed. (To obtain the Functions palette, right click on any blank space in the block diagram window). All controls and indicators that appears on the block diagram window should be placed in the while loop.



2. On the front panel, let us build the VI block diagram shown in Figure (3.1) above. First, place a led and rename it as required (Control palette>Express>LEDs).

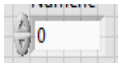

3. Then, place two “Num Ctrl” VI .Rename and resize them as required (Control palette>Express>Num Ctrls).

4. Up to this point, the front panel should looks like Figure (3.1).

5. On block diagram, drag and drop all the blocks into the while loop.



6. Place a “Multiply” from Functions>Mathematics>Numeric VI on the block diagram. Also wire a constant value by right click on the component.



7. Place a “Comparator” VI (Function>Express>Arithmetic&Comparison) on the block diagram and wire the output of the multiply function from the previous step into the comparator input. Also wire a constant value by a right click on the component.

Exercise: Simple Liquid Store System

Design a simple liquid store system in the LABVIEW with the following specifications:

1-The system has four inputs (volume of the liquid, temperature of the liquid and two enables) and two outputs (led and screen).

2-When the volume of the liquid exceeds 6 liters and led enable is on, the led will turn into Red color.

3- When the temperature of the liquid exceeds 60 ° C and temperature enable is on, the message “The temperature of the liquid is high” should be displayed on the screen.

The front panel of the system should be like figure3.3 and figure 3.4.

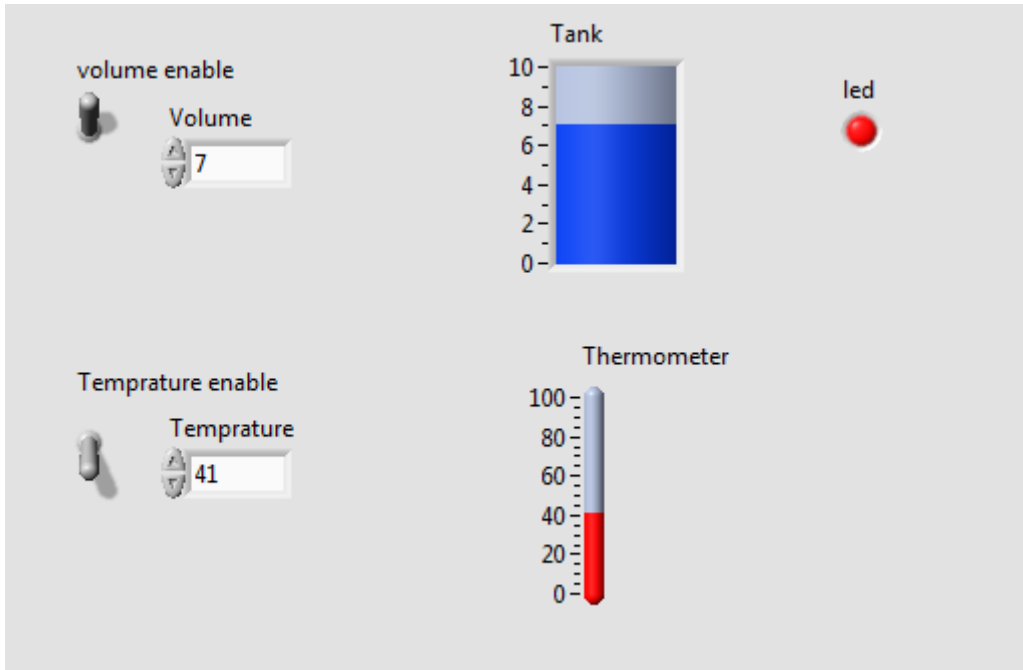

Figure 3.3 front panel of the system (condition #2)

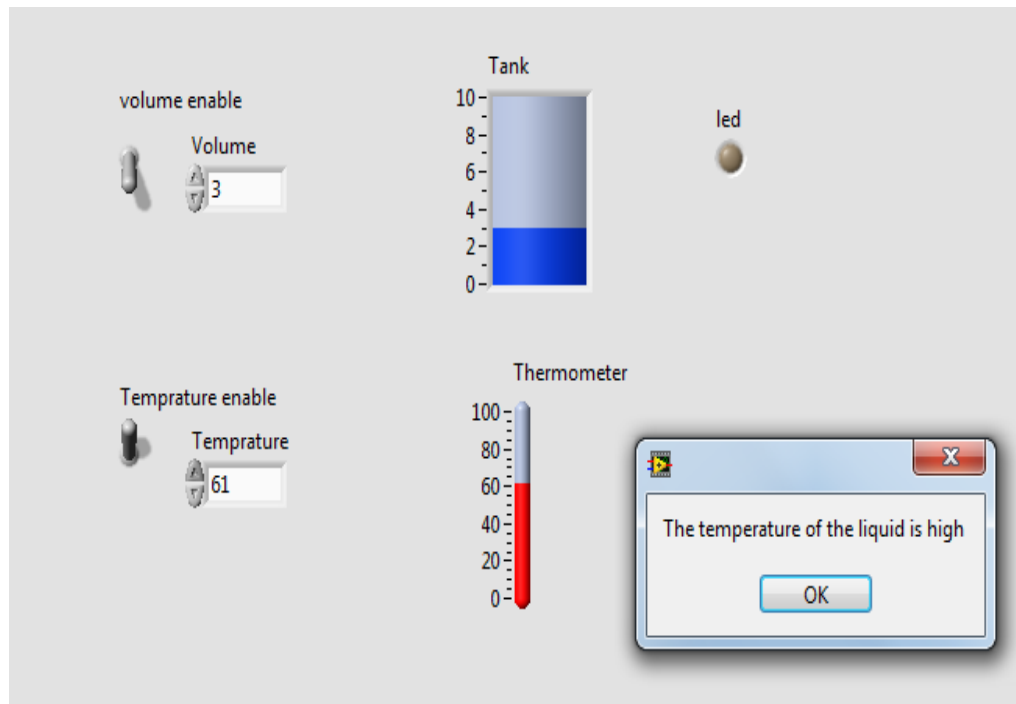

Figure 3.4 front panel of the system (condition #3)

3.2 Lowpass and Highpass filters in time domin:

- a. Build Lowpass and Highpass filters VI, then explain the result.

Notes:

- After adding the “Simulate Sig” you must add noise on it by right clicking on it “properties”.
- You can add “Filter” from Functions>Express>Signal Analysis>Filter VI on the block diagram.

The following figures Figure (3.5) and Figure (3.6) represent the front panel and block diagram of lowpass and highpass filters VI.

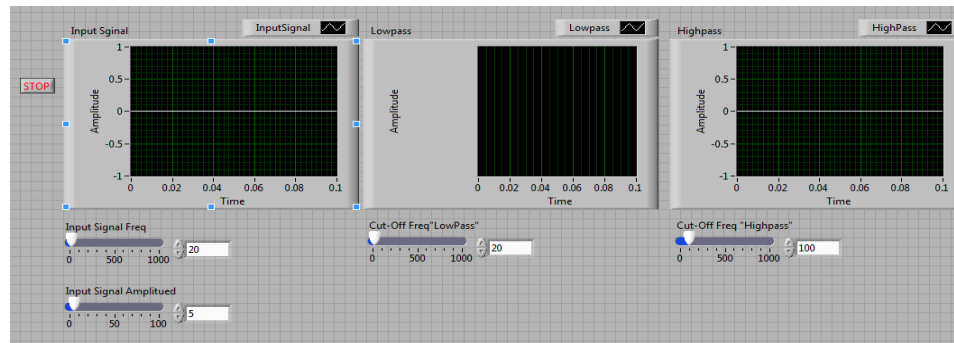

Figure (3.5) Lowpass & Highpass Filters VI Front Panel

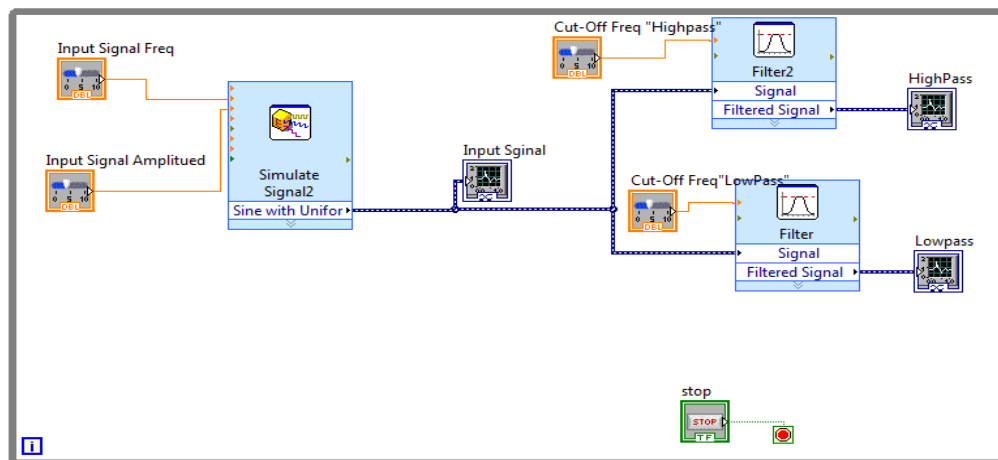

Figure (3.6): Lowpass & Highpass Filters VI Block Diagram

- b. For low pass filter try to make the cutoff frequency less than the signal frequency, for **both cases with and without noise** and explain the result in your report.
- c. For high pass filter try to make the cutoff frequency greater than the signal frequency, for **both cases with and without noise** and explain the result in your report.

Exercise : Applying Lowpass & Highpass Filters on Your Voice

1-Delete the simulate signal from previous block diagram and put Acquire Sound component in its place. See the wave form of your voice before and after the filter stage.



2-Connect the Play Waveform Component to a wire before filter stage to hear you voice. Then connect another instance of this component after LowPass filter and another one after High Pass filter. What is the difference?

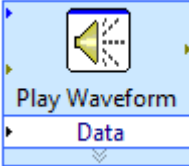

Lab Report

- 1. Report as described in the Lab Policies.
- 2. Screen Shots of the "Block Diagram" and "Front Panel" windows where only these windows and their title bars and nothing else are visible. Points will be deducted if the components are not clearly visible in these windows or if any of the Windows screen components like the "Start Button" or "Task Bar" are visible.