

**Electrical Engineering Department**  
**Prelab3**

**Student Name: abed.hmeadan**

**Id:1161306**

**Instructor: Dr. Muhammad jubran**

**section:1**

**Date:29/9/2018**

## Part A: Step response of First-order RC circuit

For the circuit of Figure 5.8 :

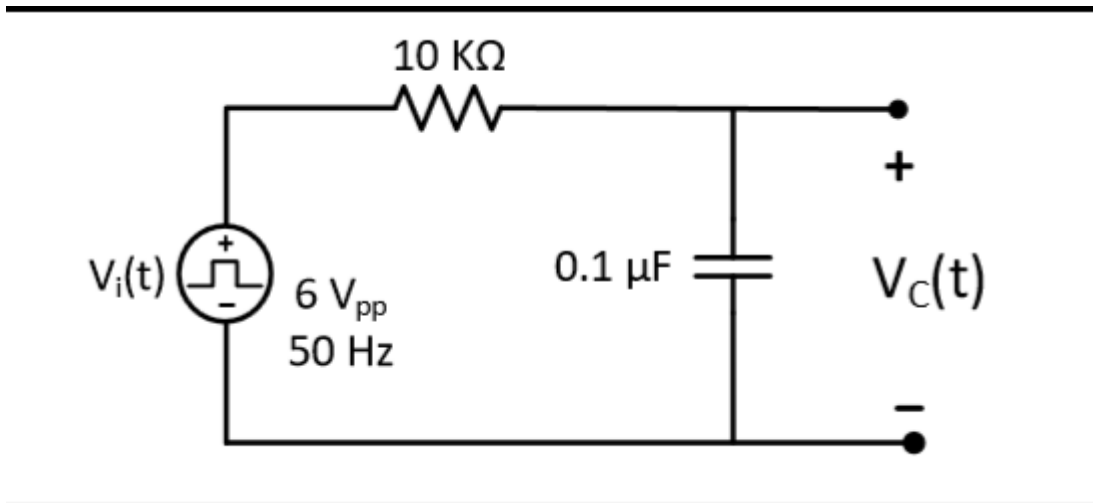

1. Calculate  $V_C(t)$  using the general solution formula, show calculation of time constant ( $\tau$ ).

$$V_C(t) = V(\infty) + (V(0) - V(\infty))e^{-t/\tau}$$

$$V(0) = 0$$

$$V(\infty) = 6V$$

$$\tau = (R_{th} * C) = (10K * 0.1 * 10^{-6}) = 1ms$$

$$V_C(t) = 6(1 - e^{-1000t})$$

2. Use PSPICE to do transient analysis of the circuit. Show  $V_C(t)$  and use cursors to measure time constant ( $\tau$ ).

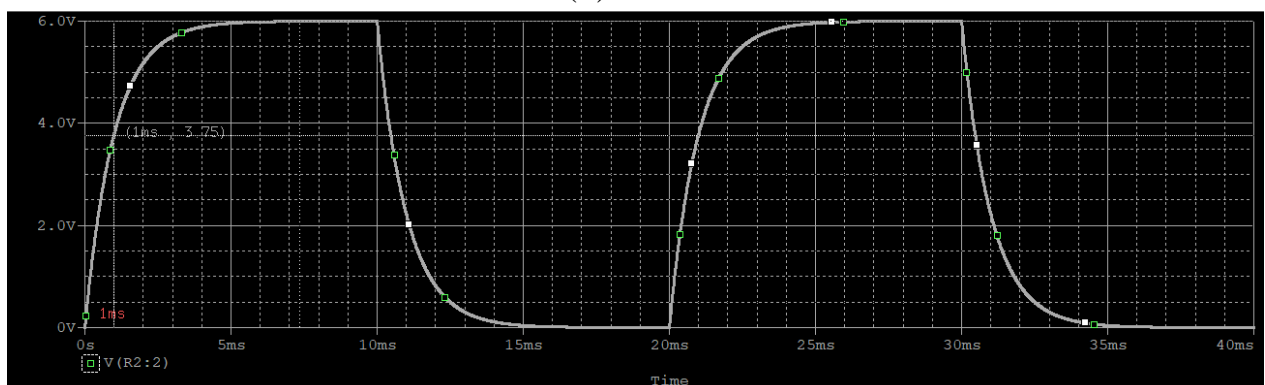

$$V(\tau) = 0.63 * V_{max} = 3.75$$

$$\tau = 1ms$$

3. For the same circuit show  $V_R(t)$  using a differential voltage marker, and use cursors to measure time constant ( $\tau$ ).

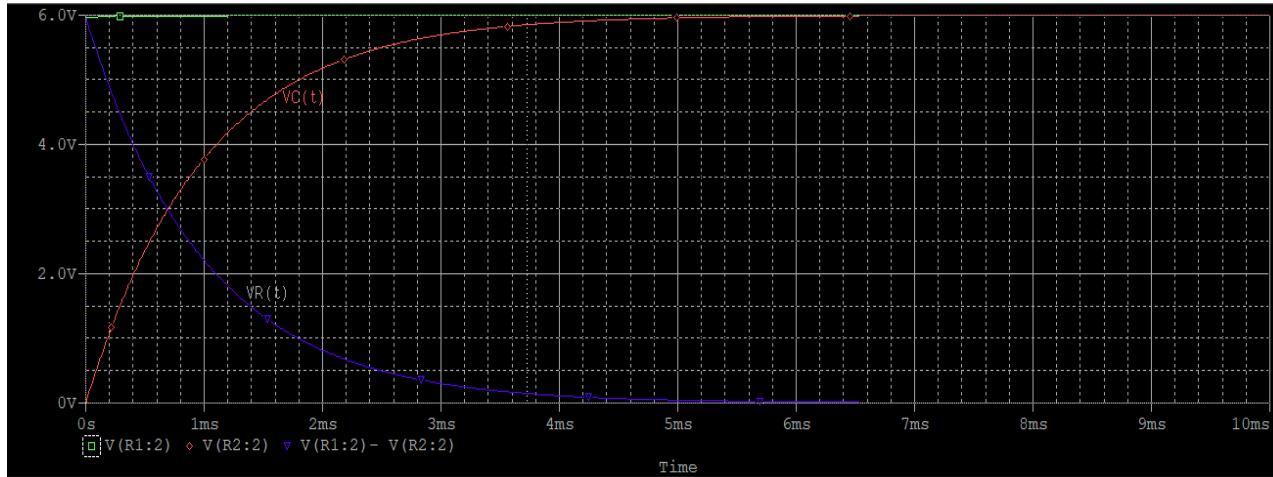

Part B: Step response of First-order RL circuit For the circuit of Figure 5.10:

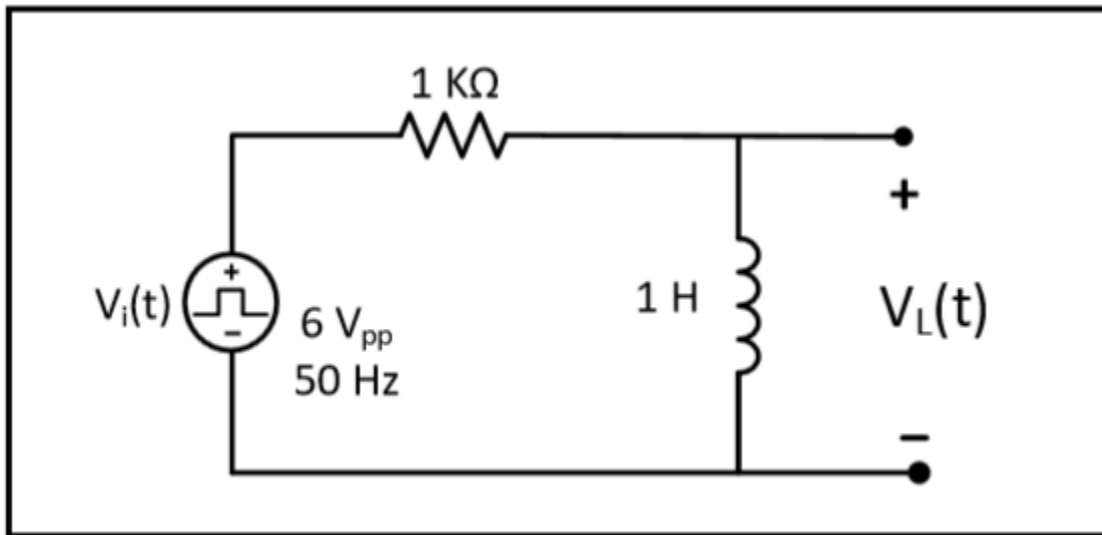

**Figure 5.10**

$$V_L(t) = V(\text{inf}) + ((V(0) - V(\text{inf}))e^{-t/\text{toe}})$$

$$V(\text{inf}) = 0$$

$$V(0) = V_{in\ max} = 6V$$

$$\tau = L/R = 1ms$$

$$V_L(t) = 6 * e^{(-1000 * t)}$$

2. Use PSPICE to do transient analysis of the circuit. Show  $V_L(t)$  and use cursors to measure time constant ( $\tau$ ).

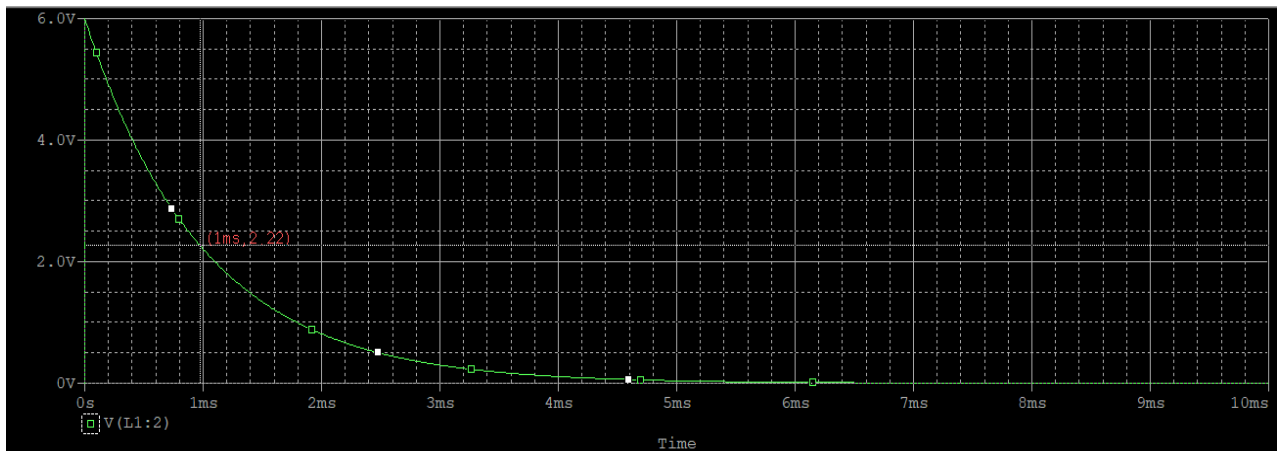

$$V(\tau) = 0.37 * V_{max} = 2.22$$

3. For the same circuit show  $V_R(t)$  using a differential voltage marker, and use cursors to measure time constant ( $\tau$ ).

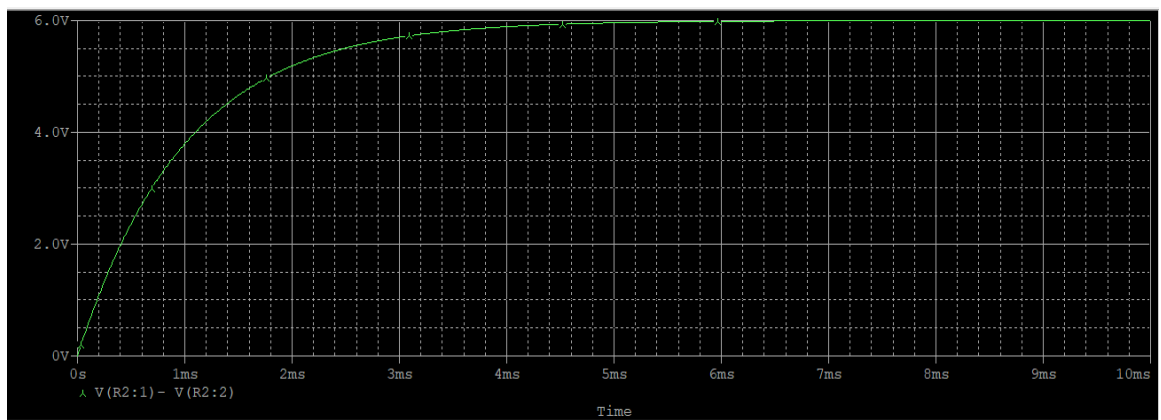

4.

Part C: Step response of second-order Series RLC circuit

For the circuit of Figure 5.12:

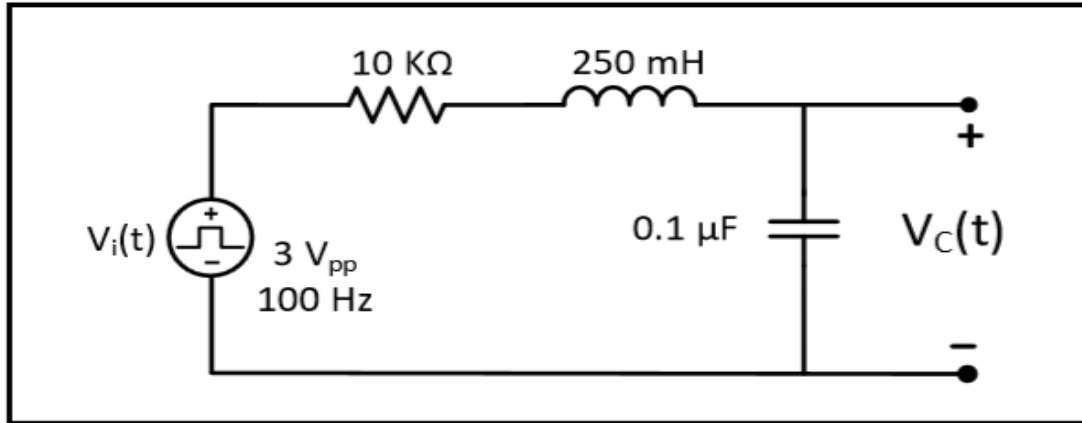

**Figure 5.12**

$$\alpha = R/(2*L) = 20000$$

$$\omega_0 = 1/(LC)^{0.5} = 6324$$

$$\alpha^2 > \omega_0^2$$

The system is over damped

$$s_{1,2} = -(\alpha) \pm (\alpha^2 - \omega_0^2)^{0.5}$$

$$s_1 = -1026$$

$$s_2 = -38974$$

$$V_c(t) = 3 + Ae^{-1026t} + Be^{-38974t}$$

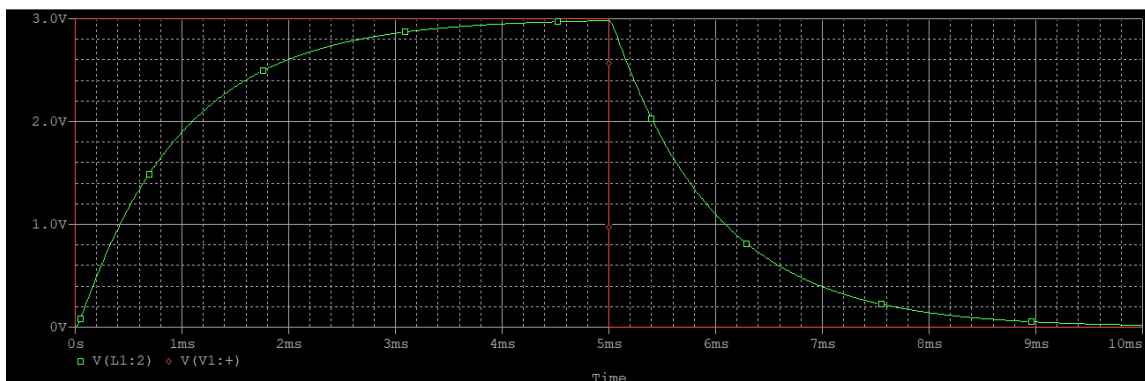

2. Calculate the critical resistance  $R_C$  that will result in equal roots ( $S_1 = S_2 = -\alpha$ ) and write an expression for  $V_C(t)$ . Use PSPICE to do transient analysis of the circuit and show  $V_C(t)$ .

$$\omega_0^2 = \alpha^2$$

$$1/(LC) = R_c^2/4L^2$$

$$R^2 = 4*L/C = 3.2 \text{ Kohm}$$

$$\alpha = R_c/2L = 6400$$

$$V_c(t) = Ae^{(-6400t)}$$

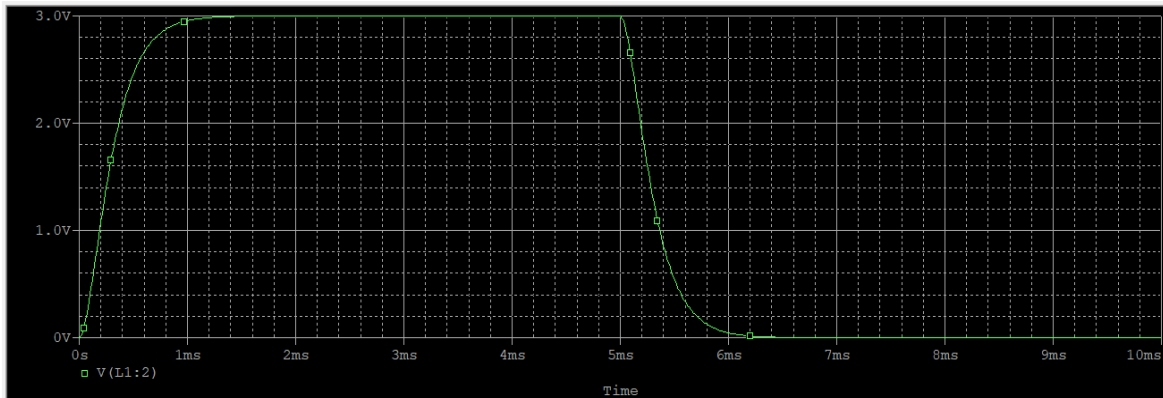

3. For  $R = 500 \Omega$ , calculate the roots of the characteristic equation, showing the value of  $\alpha$  and  $\omega_d$  and write an expression for  $V_C(t)$ . Use PSPICE to do transient analysis of the circuit, show  $V_C(t)$ , and measure  $\alpha$  and  $\omega_d$  using cursors as shown in figure 5.7.

$$\alpha = R/2L = 1000 \quad \omega_0 = 6400$$

$\omega_0 > \alpha$  the system is under damping

$$\omega_d = (\omega_0^2 - \alpha^2)^{.5} = 6320$$

$$V_c(t) = 3 + e^{(-1000t)}(A \cos 6320t + B \sin 6320t)$$

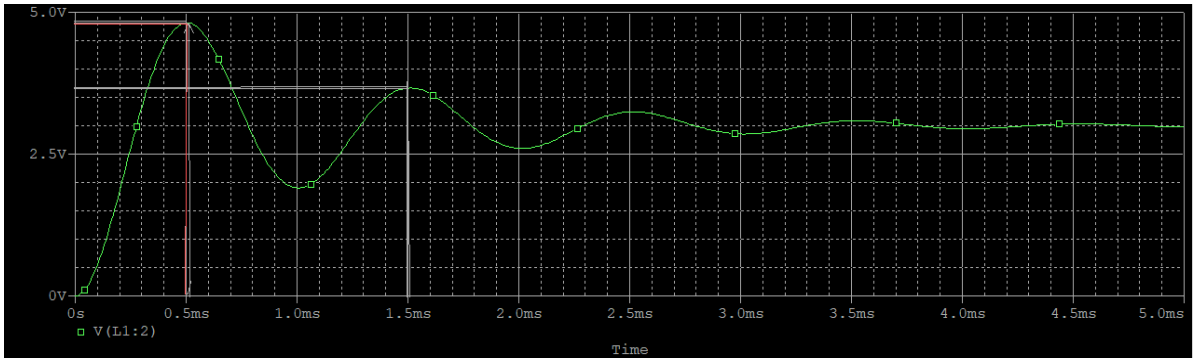

$$\tau = tb - ta / \ln(Va - Vo(\infty) / Vb - Vo(\infty))$$

$$Tb = 1.5\text{ms} \quad ta = 0.5\text{ms}$$

$$Va = 4.8 \quad Vb = 3.65 \quad v(\text{inf}) = 3\text{V}$$

$$\tau = 0.97\text{ms}$$

$$\alpha = 1/\tau = 1030$$

$$\omega_d = 2\pi / (tb - ta) = 6300$$

Part D: Step response of second-order parallel RLC circuit

For the circuit of Figure 5.13:

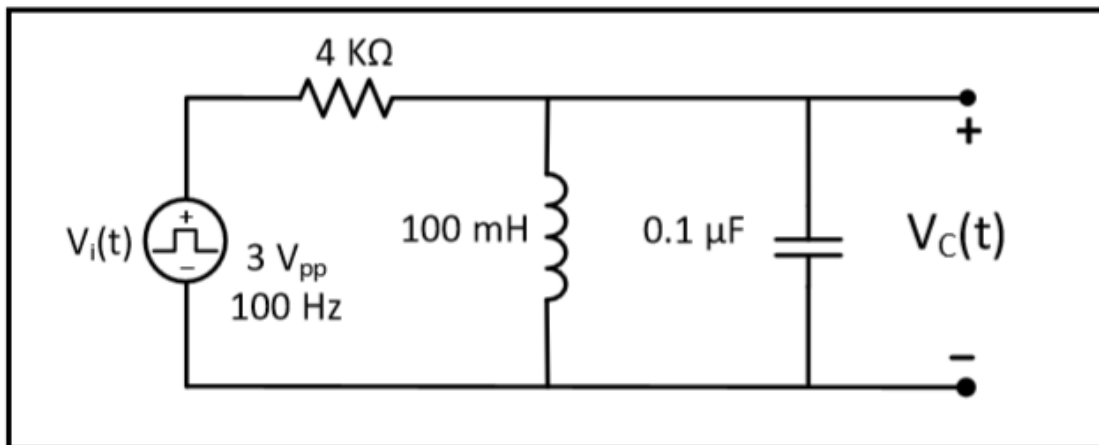

**Figure 5.13**

1. For  $R = 4\text{ k}\Omega$ , calculate the roots of the characteristic equation showing the value of  $\alpha$  and  $\omega_d$ . Write an expression of  $V_C(t)$ . Use PSPICE to do transient analysis of the circuit, show  $V_C(t)$ , and measure  $\alpha$  and  $\omega_d$  using cursors as shown in figure 5.7.

$$\alpha = 1/2RC = 1250 \quad W_0 = 10000$$

$W_0 > \alpha$  the system is under damping

$$W_d = (W_0^2 - \alpha^2)^{0.5} = 9950$$

$$V_c(t) = e^{(-1250t)} * (A \cos 9950t + B \sin 9950t)$$

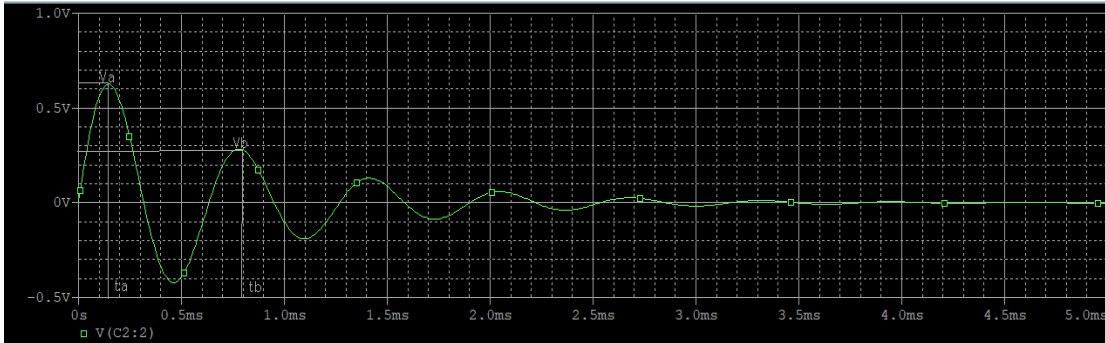

$$\tau = tb - ta / \ln(Va - Vo(\infty) / Vb - Vo(\infty))$$

$$Tb = 0.8ms \quad ta = 0.15ms \quad Va = 0.6V \quad Vb = 0.3V$$

$$\tau = 0.93ms \quad \alpha = 1066$$

$$W_d = 2\pi / tb - ta = 9700$$

2. Calculate the critical resistance RC that will result in equal roots ( $S_1 = S_2 = -$  and write an expression for VC(t). Use PSPICE to do transient analysis of the circuit and show VC(t).

$$W_0^2 = \alpha^2$$

$$R_c = (L/4C)^{0.5} = 500 \text{ ohm}$$

$$\alpha = 10000$$

$$V_c(t) = Ae^{(-10000t)}$$



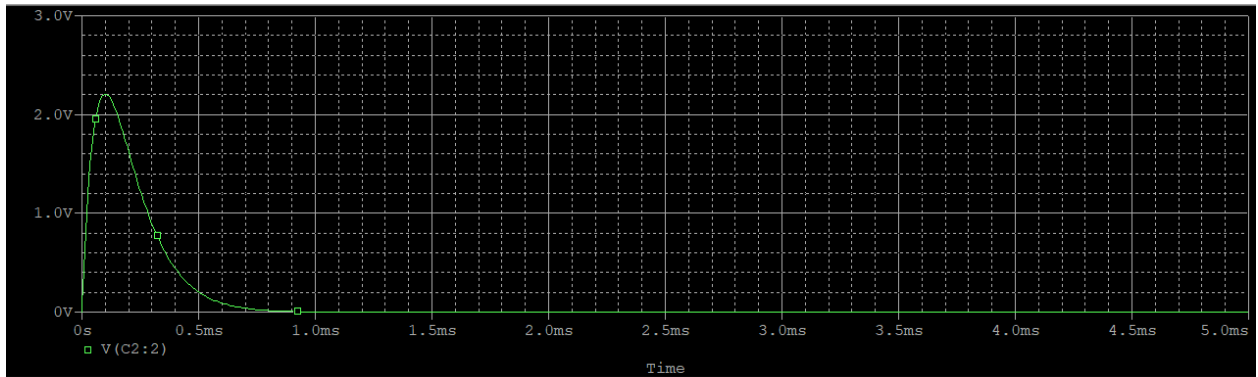

For  $R = 150 \Omega$ , calculate the roots of the characteristic equation and write an expression for  $V_C(t)$ . Use PSPICE to do transient analysis of the circuit, and show  $V_C(t)$ .

$$\alpha = 1/2RC = 33333 \quad \omega_0 = 10000$$

$\alpha > \omega_0$  the system is over damped

$$s_{1,2} = -\alpha \pm (\alpha^2 - \omega_0^2)^{0.5}$$

$$s_1 = -1535 \quad s_2 = -65130$$

$$V_C(t) = A e^{(-1535t)} + B e^{(-65130t)}$$

