



**Faculty of Engineering & Technology
Electrical & Computer Engineering Department**

Electrical Machines, ENEE2408

Course Project

Induction Motor

Student : Ismail Abu-Alia

1160876

Instructor : Dr. Mahran Quran

Section : 1

Date : May-2019

Abstract

In this project we learned how to use a Matlab (Simulink and m- file)for 3- Φ induction motor, and how to use the Simulink blocks. Also, we understand the stator voltage variation method which used to speed control method for the 3- Φ induction motor. Finally, we learn how to plot the torque speed characteristic curve and comparing the theoretical values with the simulation values .

Introduction:

Electrical machine: is a device that converts either electrical energy to mechanical energy (motor) or mechanical energy to electrical energy (generator) through action of magnetic fields .

There is two kinds of machine : Ac machines and dc machines

- 1- Synchronous machines (field current by external dc source)
- 2- Induction machines (field current by magnetic induction)

- 1- **Synchronous Machine** constitutes of both synchronous motors as well as synchronous generators. An AC system has some advantages over DC system. Therefore, the AC system is exclusively used for generation, transmission and distribution of electric power. The machine which converts mechanical power into AC electrical power is called as **Synchronous Generator** or Alternator. However, if the same machine can be operated as a motor is known as **Synchronous Motor**.

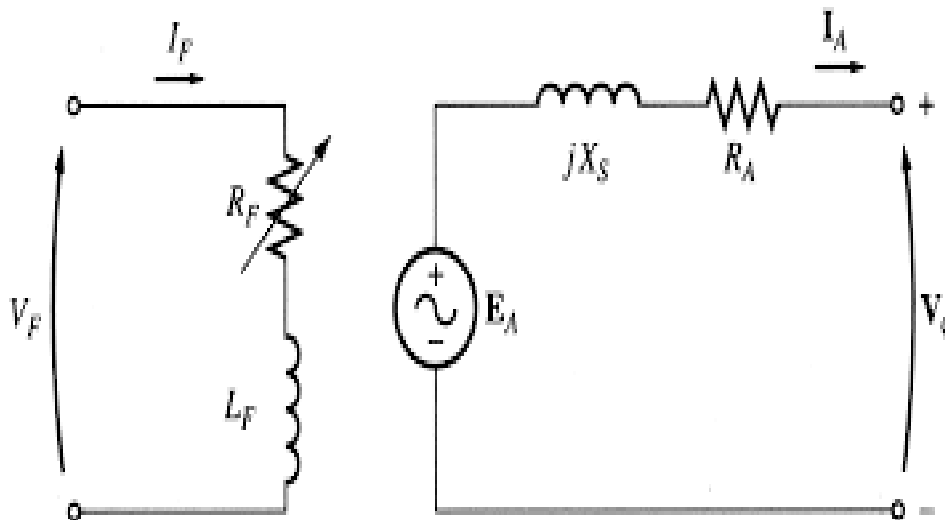

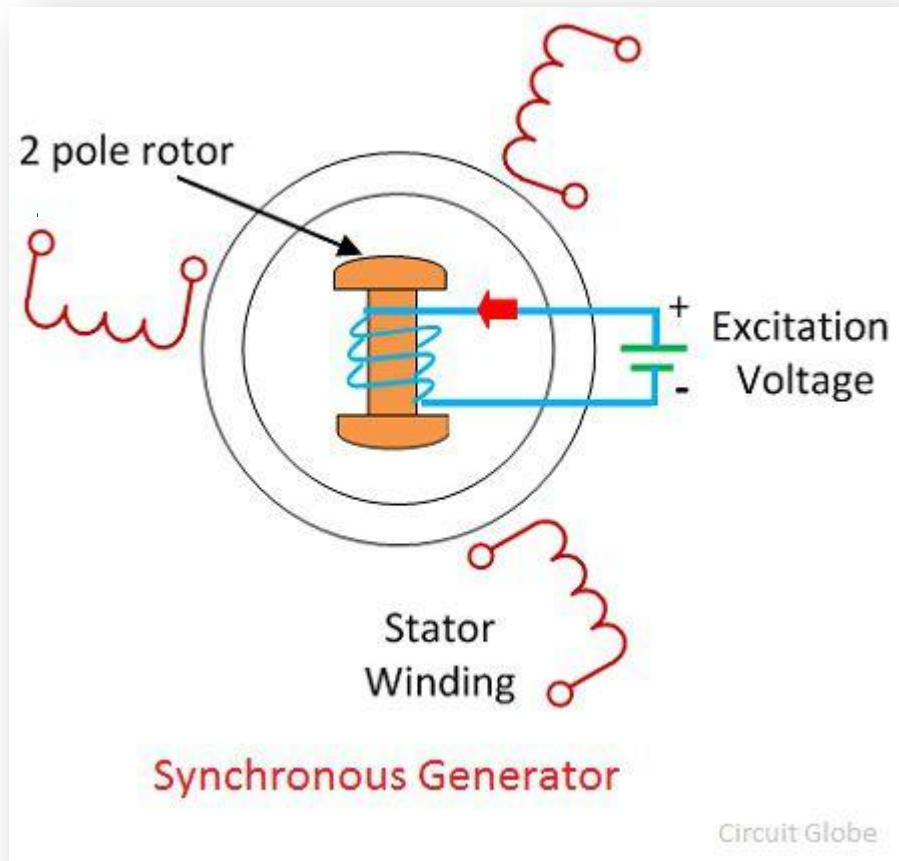

- 2- **induction machines** can be operated as either generators or motors. However, they are primarily used as induction motors. We will concentrate on motoring and later consider applications where induction generation is attractive.
- **Induction machines** are by far the most common type of motor used in industrial, commercial or residential settings. (One notable exception may be in computer equipment, where there are significant numbers of motors used for hard drives, DVD players etc.) Depending on location (which affects other electrical energy uses, such as lighting, space heating) induction motors may consume up to 70% of all electrical energy generated. There are two underlying reasons why induction motors are *the* general purpose motor of choice:
 - Induction motors are relatively cheap
 - Induction motors are robust

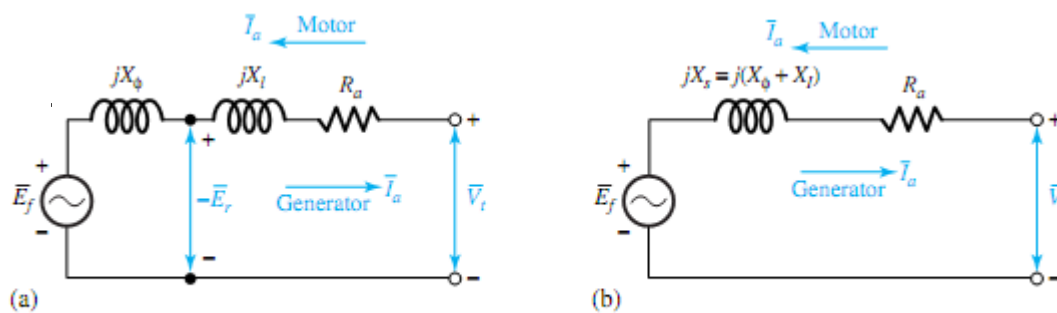

Per-phase equivalent circuits of a cylindrical-rotor synchronous machine.

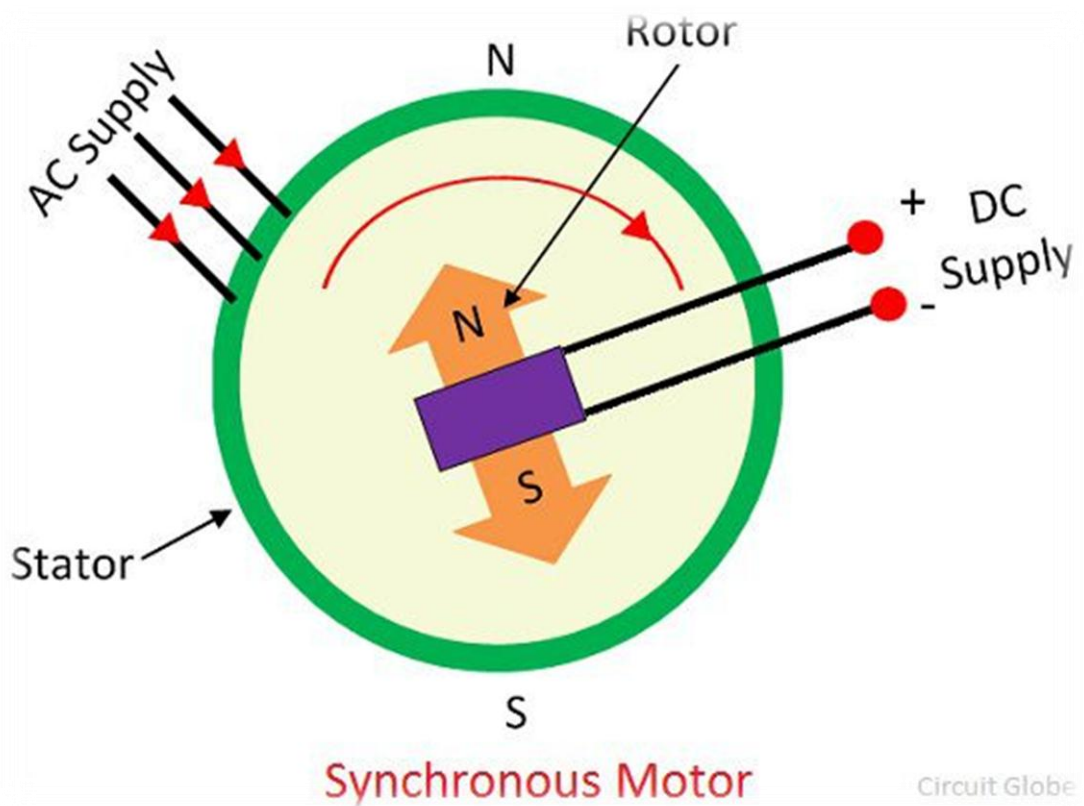

We will focus on induction machine (induction motors)

There are **two** main types of AC Motors such as :

- 1) **Synchronous Motors.**
it's working at synchronous speed, η_s .
- 2) **Asynchronous Motors.**
Its operating at speed less than η_s .

The motor consists from two main parts :

- Stator : and it's the stationary part of the machine.
- Rotor : and it's the rotating part of the machine.

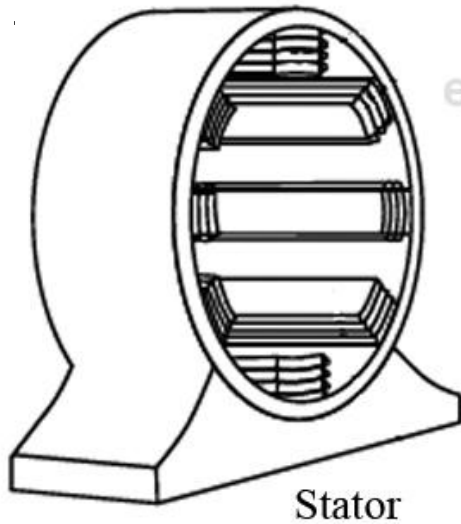

electricaleasy.com

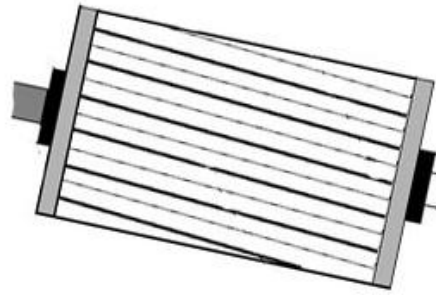

Squirrel cage rotor



Stator

Squirrel cage rotor

Theory:

3- Φ Induction Motors:

As I mentioned before induction machine are produced the field current by inductions (Transformer action) ,here I will talk about one kind of induction machine which is **Induction motors** (our project)

The construction of induction motors :

- 1- **Stator** : it has the same construction of synchronous motor ,with different rotor construction .
- 2- **Rotor** : there is tow rotor types :
 - **Cage rotor** : its consists of series bars conducting bars laid into slots carved in the face of rotor and shorted by large short rings .

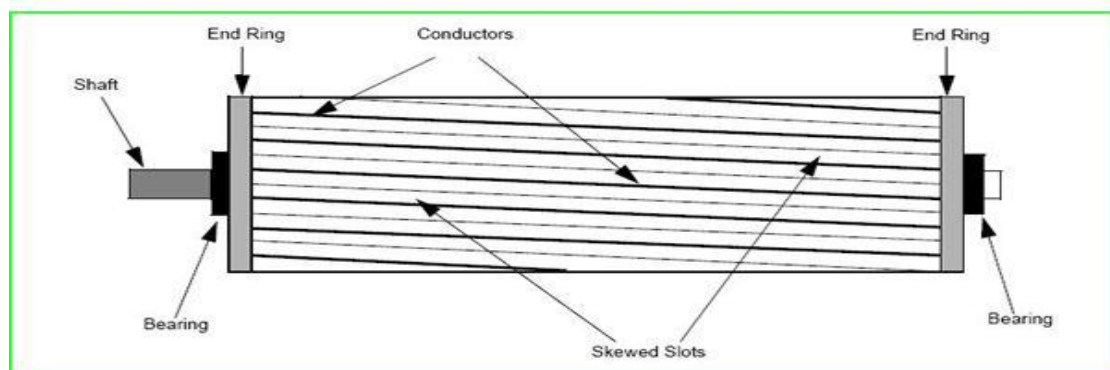

- **Wound rotor** : it consists of a set of 3- Φ windings that are mirror to the stator winding. the winding are usually y- connected .the terminals a,b and c are tied to sliprings in the rotors shaft the terminal are shorted via brushes.

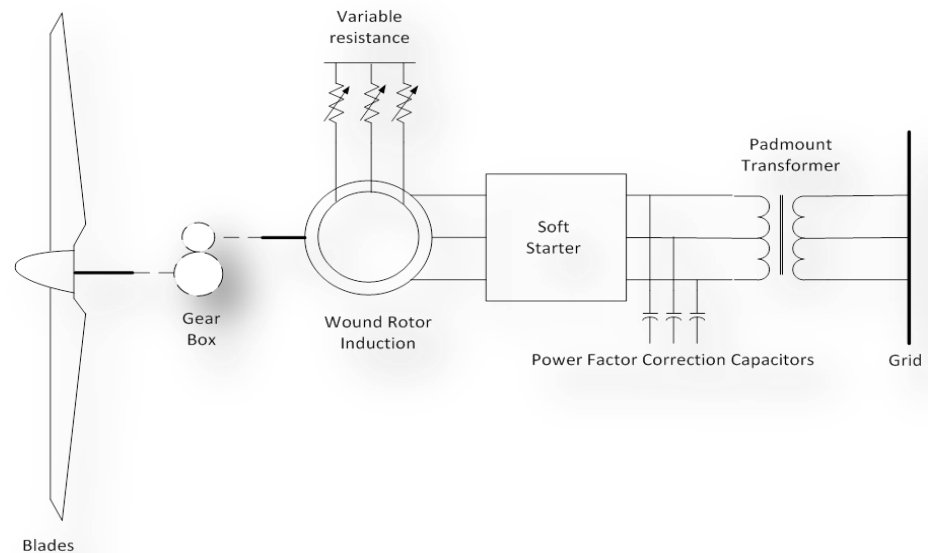

Operating principle of induction motors:

The induction motor is the single excited motor, i.e., the supply is applied only to the one part, i.e., stator. The term excitation means the process of inducing the magnetic field on the parts of the motor.

- 1- When the three phase supply is given to the stator, the rotating magnetic field produced on it, B_s which rotated at synchronous speed, n_s .

$$\text{Synchronous speed } (n_s) = \frac{120}{P} f_e \dots (1), \text{ where}$$

f_e : electric frequency.

P : number of poles.

INDUCTION MOTOR

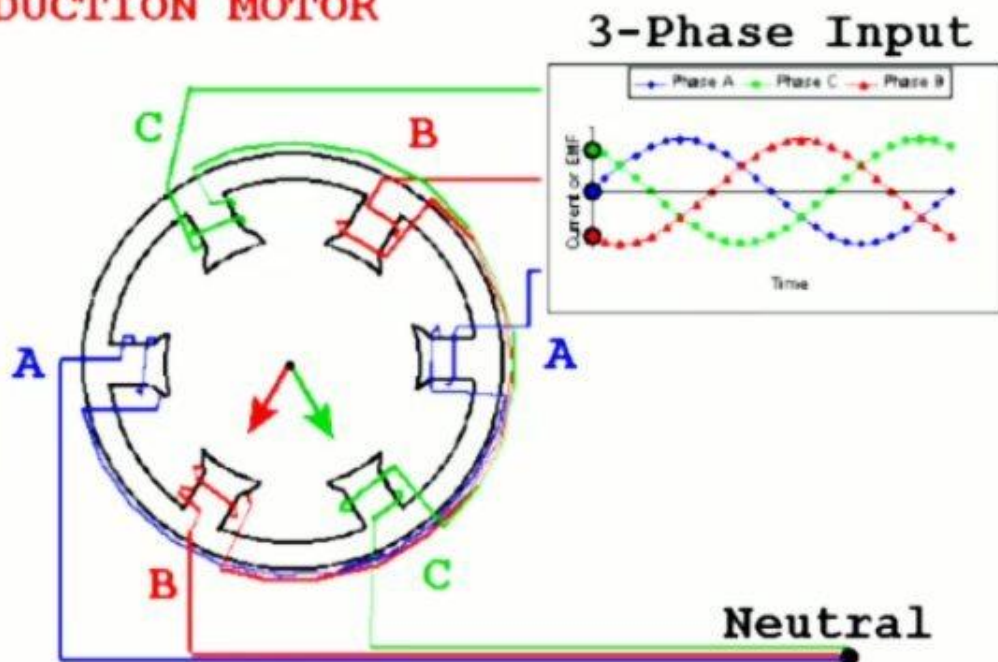

- 2- After producing rotating magnetic field B_s , The conductors of the rotor are stationary. This stationary conductor cut the rotating magnetic field of the stator, and because of the electromagnetic induction, the EMF induces in the rotor (induced voltage)

$$e_{ind} = (V \times B_s) \cdot L \quad (2) \text{ where ,}$$

L: the length of the bars

V: the relative velocity between the bars and B_s .

- 3- The conductors of the rotor are short-circuited either by the end rings, The relative motion between the rotating magnetic field and the rotor conductor induces the current in the rotor conductors I_r . As the current flows through the conductor, the flux induces on it which called B_r . The direction of rotor flux is same as that of the rotor current.

- 4- Now we have two fluxes(B_s , B_r) one because of the rotor and another because of the stator. These fluxes interact each other.

So the interaction of two magnetic field produced and **induced torque** as the relation

$$T_{ind} = K B_r \times B_s \dots (3) \text{ , where k: is the constant representing the construction of machine}$$

- 5- The direction of electromagnetic torque and rotating magnetic field is same.
- 6- the rotor starts rotating in the same direction as that of the rotating magnetic field.

Note: The speed of the rotor is always less than the rotating magnetic field or synchronous speed. The rotor tries to run at the speed of the rotor, but it always slips away, so we need to know the new concept, called the slip, which came from the idea of that the rotor slips away from the \mathbf{B}_s speed which rotates at synchronous speed η_s .

The slip (σ) : it's the ratio of slip speed and synchronous speed

slip speed $\rightarrow \eta_\sigma = \eta_s - \eta_m \dots (4)$, where η_m is the mechanical speed

$$\sigma = \frac{\eta_\sigma}{\eta_s} \dots (5)$$

$$\rightarrow \eta_m = \eta_s (1 - \sigma) \dots (6)$$

Rotor frequency (f_r) : when the rotor is locked ($\eta_m=0, \sigma=1$),

Here, $f_e = f_r$, when the rotor turns at η_s ($\sigma=0$) **here, $f_r=0$** ,

So at any other speed than η_s , the rotor frequency is proportional to the slip so, $f_r = \sigma f_e$.

QUESTION: Why the rotor can't reach the synchronous speed?

Simply when the rotor mechanical speed reaches the synchronous speed, there will be no relative speed between the rotor and stator magnetic field, by relation $e_{ind} = (\mathbf{V} \times \mathbf{B}_s)$ so will be no induced voltage.

*****equivalent circuit for induction motor:**

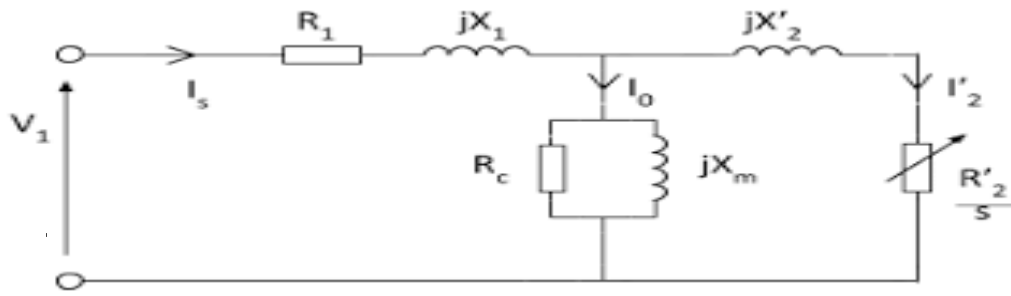

Where:

R_1 : Resistance of stator windings

R_c : Resistance of core accounting for eddy current and hysteresis.

R'_2 : Resistance of rotor.

X_2 : Rotor leakage reactance.

X'_2 : Stator leakage reactance.

I_s : Stator current

I_2 : Rotor current.

Theoretical relations for induction motors:

The torque induced:

$$T_{\text{ind}} = \frac{3 V_{th}^2}{\omega_s \left[\left(R_{th} + \frac{R_r'}{\sigma} \right)^2 + (X_{th} + X_{r'})^2 \right]} \cdot \frac{R_r'}{\sigma} \dots (7)$$

$$\text{the maximum slip } \sigma_{\text{max}} = \frac{R_r'}{\sqrt{R_{th}^2 + (X_{th} + X_{r'})^2}} \dots (8)$$

$$\text{The maximum torque is : } T_{\text{max}} = \frac{3 V_{th}^2}{2 \omega_s [R_{th} + \sqrt{R_{th}^2 + (X_{th} + X_{r'})^2}]} \dots (9)$$

the starting torque ($\sigma = 1$):

$$T_{\text{start}} = \frac{3 V_{th}^2}{\omega_s [(R_r' + R_{th})^2 + (X_{th} + X_{s'})^2]} \cdot R_r' \dots (10)$$

There are 4 ways of speed control of induction motor

1) changing the rotor resistance [for the wound rotor].

2) Variable voltage variable frequency.

3) changing the number of poles.

4) changing the line voltage.

And there are two ways to change the motor line voltage as :

1) Auto transformer [VAR\AC]

2) 3- ϕ AC regulator .

Calculations, results and discussion

A) The Input line voltage is 400 V.

$$\text{fan load: } T_{\text{Load}} = C\omega_m^2$$

$$\text{So, } C = \frac{T_{\text{Load}}}{\omega_{m,\text{rated}}^2}$$

$$T_{\text{rated}} = \frac{P_{\text{rated}}}{\omega_{m,\text{rated}}} ;$$

$$\omega_{m,\text{rated}} = (1440 \text{ rpm} * \frac{2\pi}{60}) = 150.80$$

$$= \frac{7.5 \text{ K}}{150.72} = 49.77 \text{ N.m}$$

$$C = \frac{49.77}{(150.7)^2} = 2.2 \times 10^{-3}$$

To find the leakage reactance (X)

$$X = j \omega L ; \omega = 2\pi f_e.$$

$$X_s = j0.95613 \Omega$$

$$X_r = j0.95613 \Omega$$

$$X_m = j38.9674 \Omega$$

Now, to find the slip,

$$\eta_m = \eta_s (1 - \sigma)$$

$$1440 = 1500 (1 - \sigma) \rightarrow \sigma = 0.04$$

$$Z_{equ} = [(18.505 + j0.95613) // (j38.9674) + (0.7384 + j0.95613)]$$

$$Z_{equ} = 17.10 \angle 29.5^\circ$$

$$\text{So, } I_s = \frac{400/\sqrt{3}}{17.10 \angle 29.5} = 13.5 \angle -29.5$$

$$[\text{PF}] = 0.87 \text{ Lagging .}$$

$$P_{in} = 3V_s I_s \text{ PF} = 8137 \text{ Watt.}$$

$$P_{scl} = 3 I_s^2 R_s = 3 (13.5)^2 (0.7384) = 403.72 \text{ Watt.}$$

$$P_{core} = 0 .$$

$$P_{AG} = P_{in} - P_{scl} = 7733.28 \text{ Watt.}$$

$$P_{conv} = (1 - \sigma) P_{AG} = 7423.95 \text{ Watt.}$$

$$P_{AG} = \frac{3 I_r'^2 R_r}{\sigma} \rightarrow I_r' = 11.8 \text{ A.}$$

$$P_{out} = P_{conv} = T_{ind} \omega_m = 7423.95.$$

$$T_{ind} = 49.26 \text{ N.m}$$

$$\text{efficiency, } \eta = \frac{P_{out}}{P_{in}} = \frac{7423.95}{8137} = 91.23\%$$

$$\sigma_{\max} = \frac{Rr'}{\sqrt{Rth^2 + (Xth + Xr')^2}}$$

$$\sigma_{\max} = 0.36.$$

Now, to find the maximum torque

$$T_{\max} = \frac{3 Vth^2}{2\omega_s [Rth + \sqrt{Rth^2 + (Xth + Xr')^2}]}$$

$$R_{th} = R_s = 0.7384$$

$$X_{th} = X_s = 0.95013 \text{ ,,}$$

$$V_{th} = V_s = \frac{400}{\sqrt{3}} = 230.9 \text{ Volt.}$$

$$T_{\max} = 179.6 \text{ N.m}$$

$$\omega_s = 157$$

$$\omega_m = 150.72$$

$$\text{the power, } P = T_{\text{ind}} \omega_m = (49.26) [(1-0.04) (157)]$$

$$P = 7424 \text{ Watt.}$$

B) The Input line voltage is 150 V.

Here we have to solve this complicated eq:

$$T_{\text{ind}} = \frac{3 Vth^2}{\omega_s \left[\left(Rth + \frac{Rr'}{\sigma} \right)^2 + (Xth + Xr')^2 \right]} \cdot \frac{Rr'}{\sigma} = C \omega^2 m$$

$$0.002187(1-\sigma)(157)^2 = \frac{3(86.6)^2(0.7402)}{157 \left[\left(\frac{0.7402}{\sigma} + 0.7384 \right)^2 + (1.912)^2 \right]} \cdot \frac{1}{\sigma}$$

After sloving it we get:

$$\sigma = 0.3133$$

$$V_{Th} = 86.6 \text{ Volt.}$$

$$T_{\text{ind}} = \frac{3 V_{\text{th}}^2}{\omega_s \left[\left(R_{\text{th}} + \frac{R_r'}{\sigma} \right)^2 + (X_{\text{th}} + X_{r'})^2 \right]} \cdot \frac{R_r'}{\sigma} = 24.7 \text{ N.m}$$

$$Z_{\text{equ}} = [(2.363 + j0.95613) // (j38.9674) + (0.7384 + j0.95613)]$$

$$Z_{\text{equ}} = 3.372 \angle 37.0^\circ$$

$$\text{So, } I_s = \frac{150/\sqrt{3}}{3.372 \angle 37.0} = 25.68 \angle -37.0$$

The power factor [PF] = 0.80 Lagging .

$$P_{\text{in}} = 3 V_s I_s \text{ PF} = 5337.5 \text{ Watt.}$$

$$P_{\text{scl}} = 3 I_s^2 R_s = 3 (25.68)^2 (0.7384) = 1460 \text{ Watt.}$$

$$P_{\text{core}} = 0 .$$

$$P_{\text{AG}} = P_{\text{in}} - P_{\text{scl}} = 3878.6 \text{ Watt.}$$

$$P_{\text{conv}} = (1 - \sigma) P_{\text{AG}} = 2663.26 \text{ Watt.}$$

$$P_{\text{AG}} = \frac{3 I_r'^2 R_r'}{\sigma} \rightarrow I_r' = 23.379 \text{ A.}$$

$$P_{\text{out}} = P_{\text{conv}} = T_{\text{ind}} \omega_m = 2663.26.$$

$$T_{\text{ind}} = 24.7 \text{ N.m}$$

$$\text{the efficiency } \eta, \eta = \frac{P_{\text{out}}}{P_{\text{in}}} = \frac{2663.26}{5337} = 50.0\%$$

$$\text{the slip max as equation 8, } \sigma_{\text{max}} = \frac{R_r'}{\sqrt{R_{\text{th}}^2 + (X_{\text{th}} + X_{r'})^2}}$$

$$\sigma_{\text{max}} = 0.36$$

$$\text{to find the maximum torque } T_{\text{max}} = \frac{3 V_{\text{th}}^2}{2 \omega_s [R_{\text{th}} + \sqrt{R_{\text{th}}^2 + (X_{\text{th}} + X_{r'})^2}]}$$

$$R_{\text{th}} = R_s = 0.7384$$

$$X_{\text{th}} = X_s = 0.95013$$

$$V_{\text{th}} = V_s = \frac{150}{\sqrt{3}} = 86.6 \text{ Volt.}$$

$$T_{\text{max}} = 25.698 \text{ N.m}$$

$$\omega_s = 157$$

$$\omega_m = 107$$

$$\text{the power, } P = T_{\text{ind}} \omega_m = (24.7) [(1-0.313) (157)]$$

$$\rightarrow P = 2642.9 \text{ Watt.}$$

for the Simulink part, this circuit was drawn |

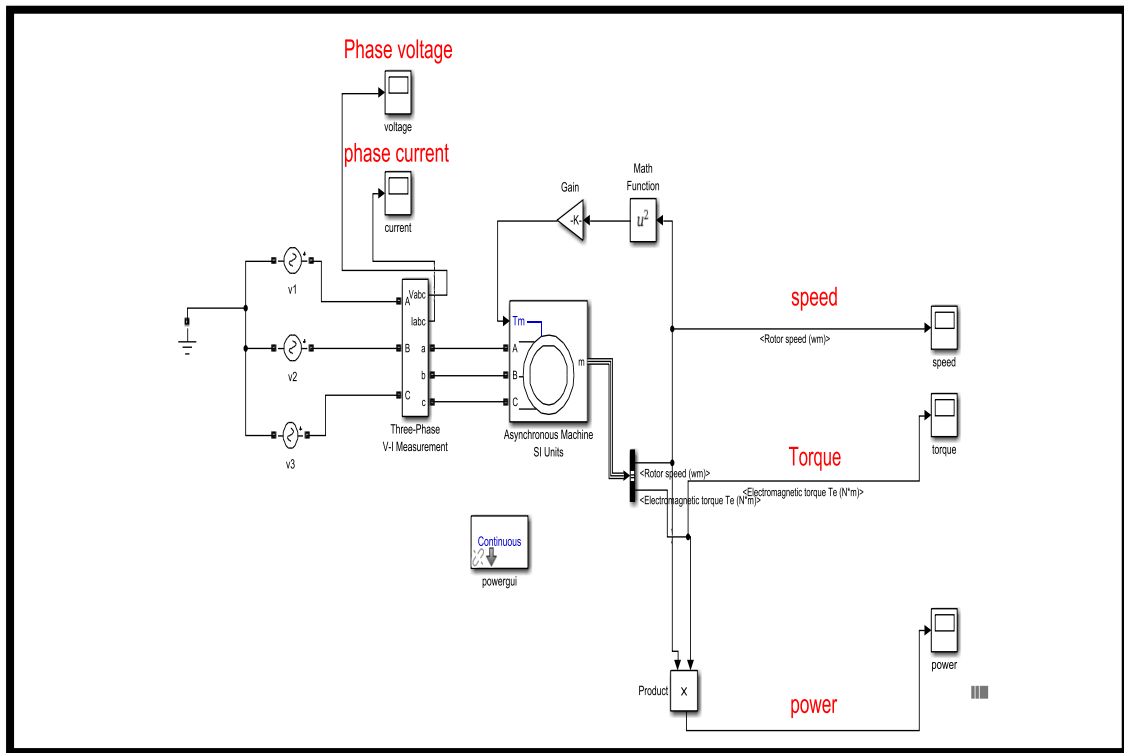

at 400 Volts : the Voltages were plotted as the figure shown :

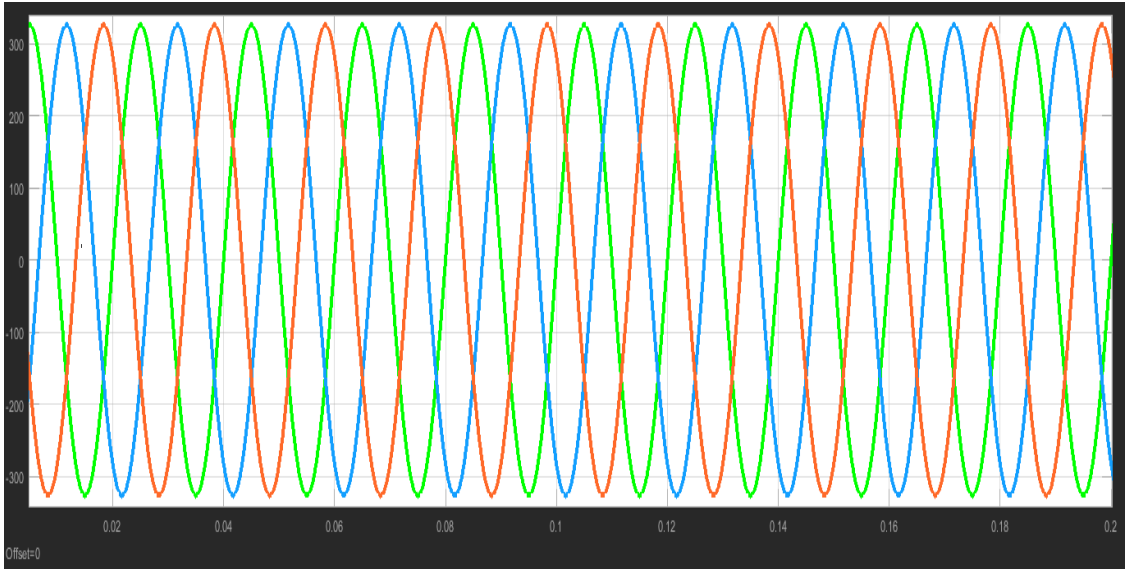

Then, the **currents** as shown :

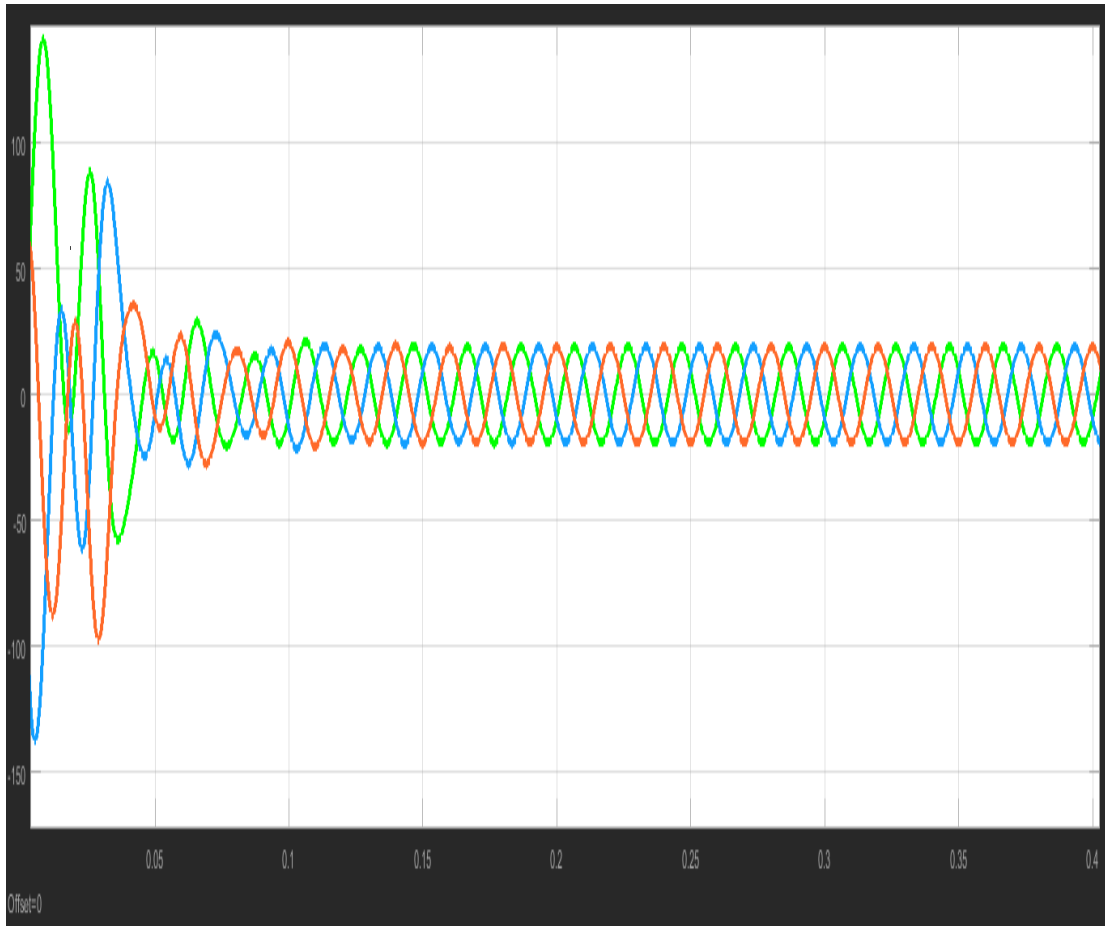

Here ,we note that the currents at starting is higher ,this because of the the starting torque ,then the currents will reach the steady state value .also we can notice that the theoretical value is closet to the value in the figures .

Then the rotor speed as shown :

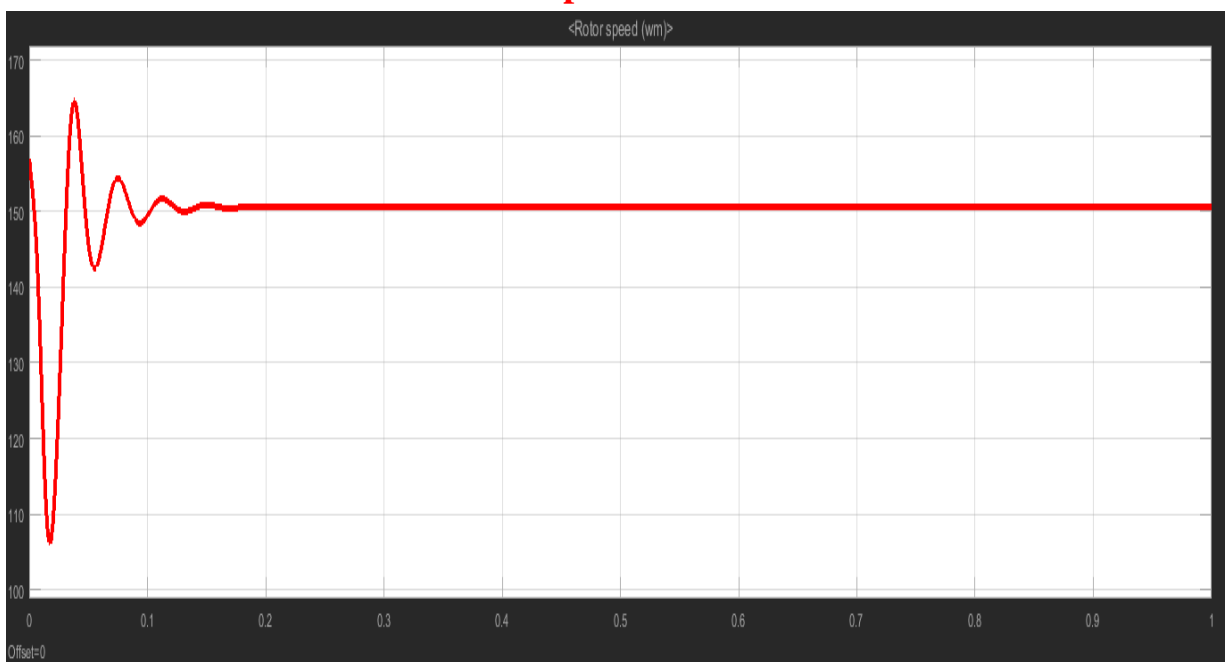

Here ,we note that the speed at starting is higher than the steady state speed ,then the speed will reach the steady state value .also we can notice that the theoretical value is closet to the value in the figures .

Note : the speed will not reach the synchronous speed but its close .

Then the torque as shown :

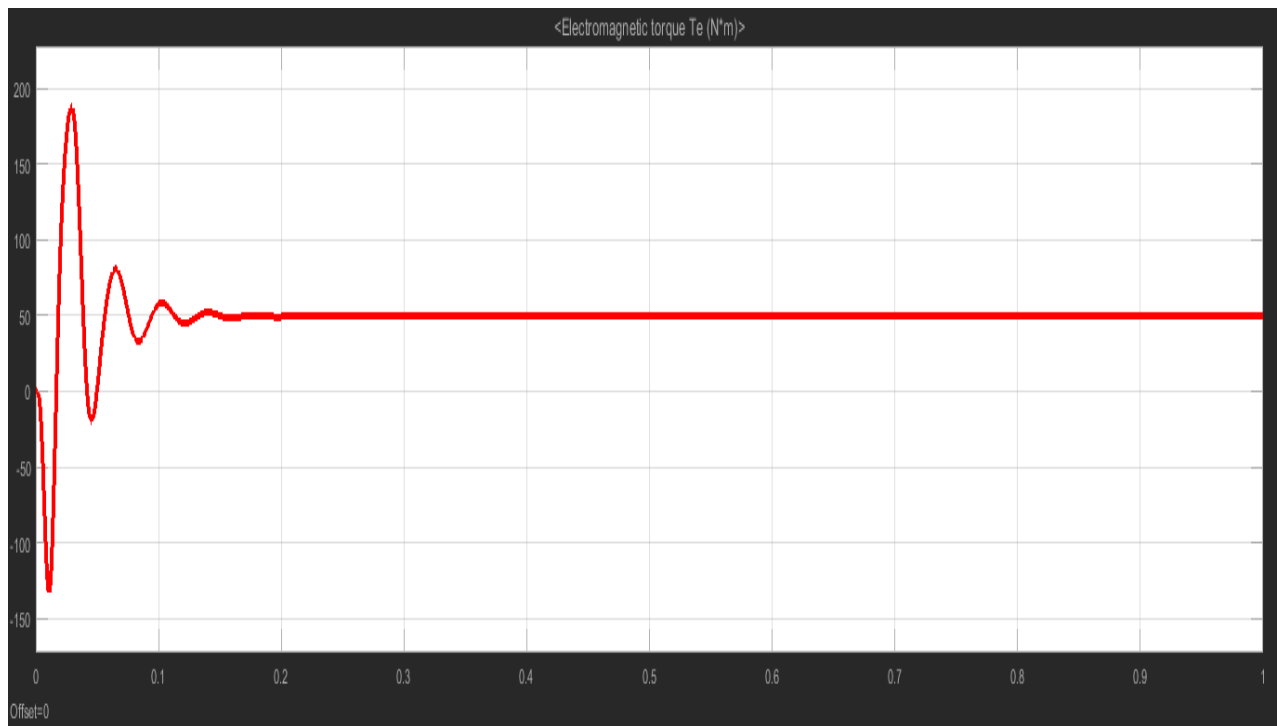

From the figure above ,it obvious that the starting torque is high ,which is =180 then after a while the torque will decrease to reach a steady state value =50 ,as we see at calculation part

The mechanical power is ;

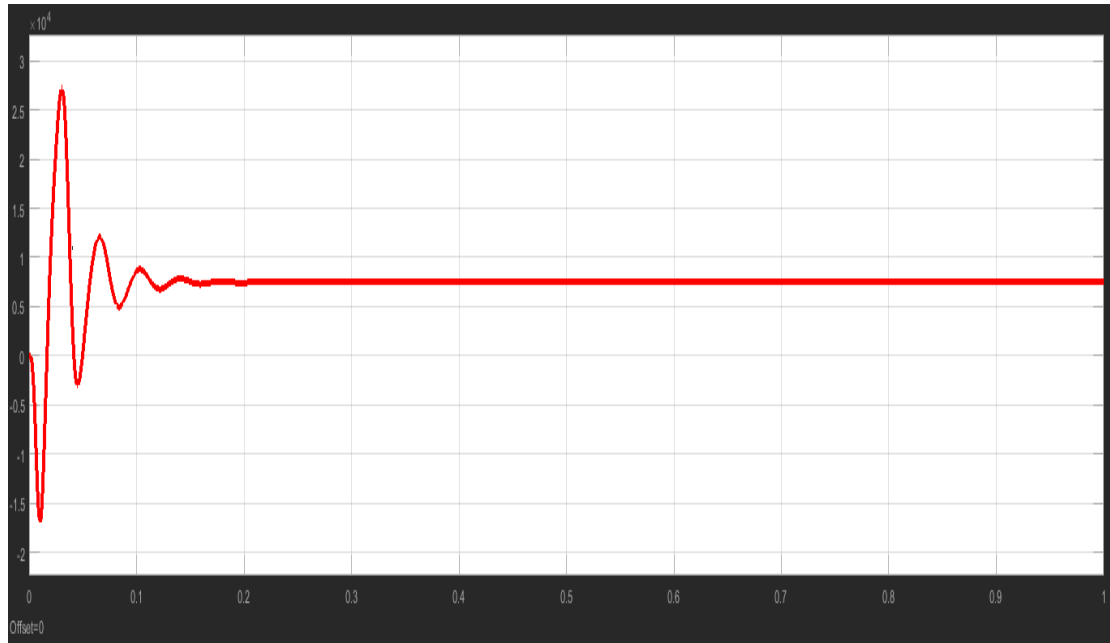

For the second part as the voltage was 150 V .

The same figures as above were done, but with different value of the voltage input.
So, the first plot was
the phase voltages :

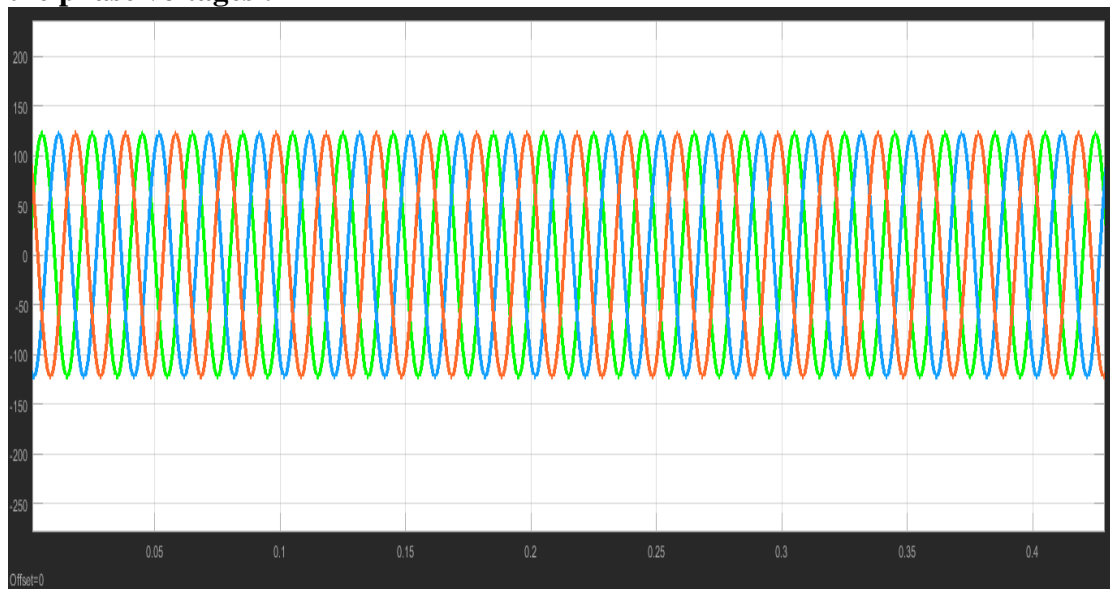

Then the input current as shown :

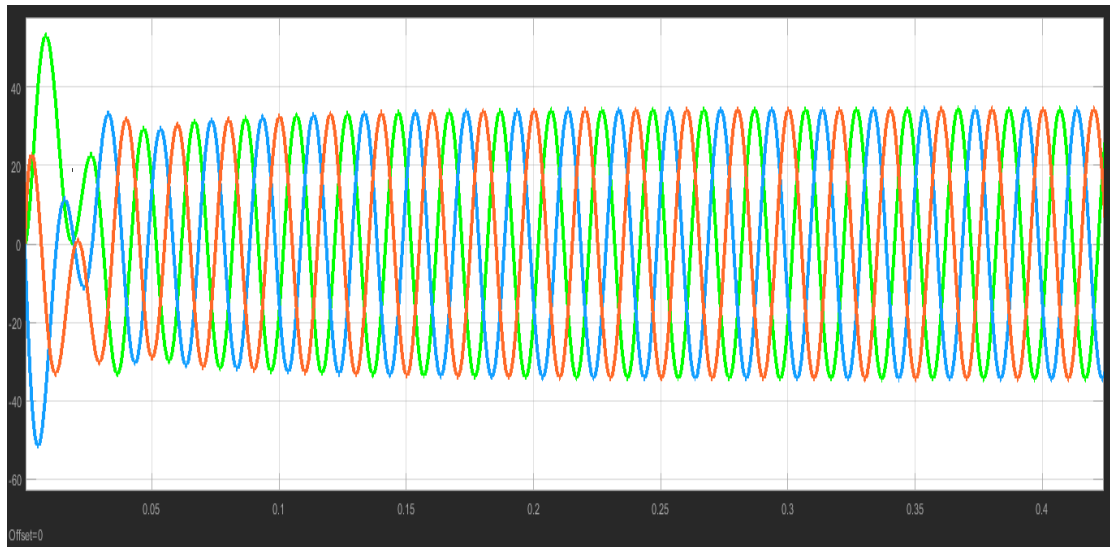

Here ,we note that the currents at starting is higher ,this because of the the starting torque ,then the currents will reach the steady state value .also we can notice that the theoretical value is closet to the value in the figures .

The rotor speed shown as :

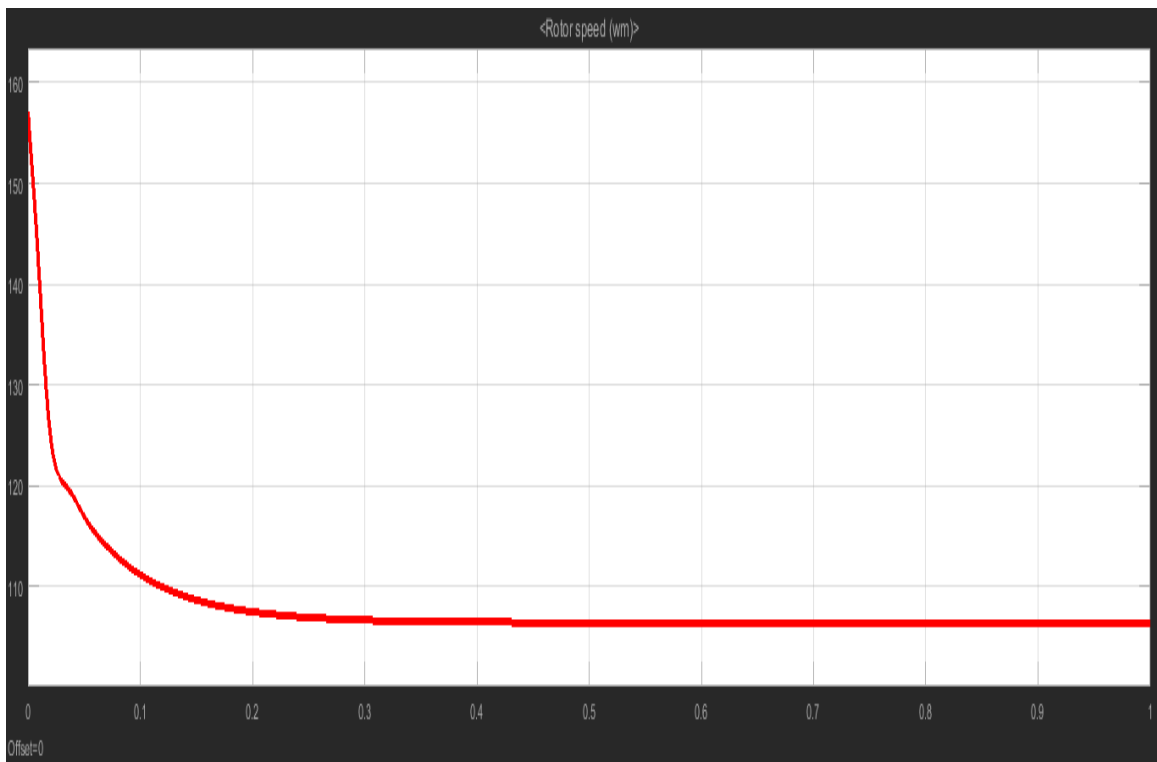

Here the rotor speed when the volt changed its will decrease to the point lowest than the speed at 400 volt ,so we note that when the voltage changed the speed will change too. for the first part the speed was 150.72 but here 107

.The Torque as shown :

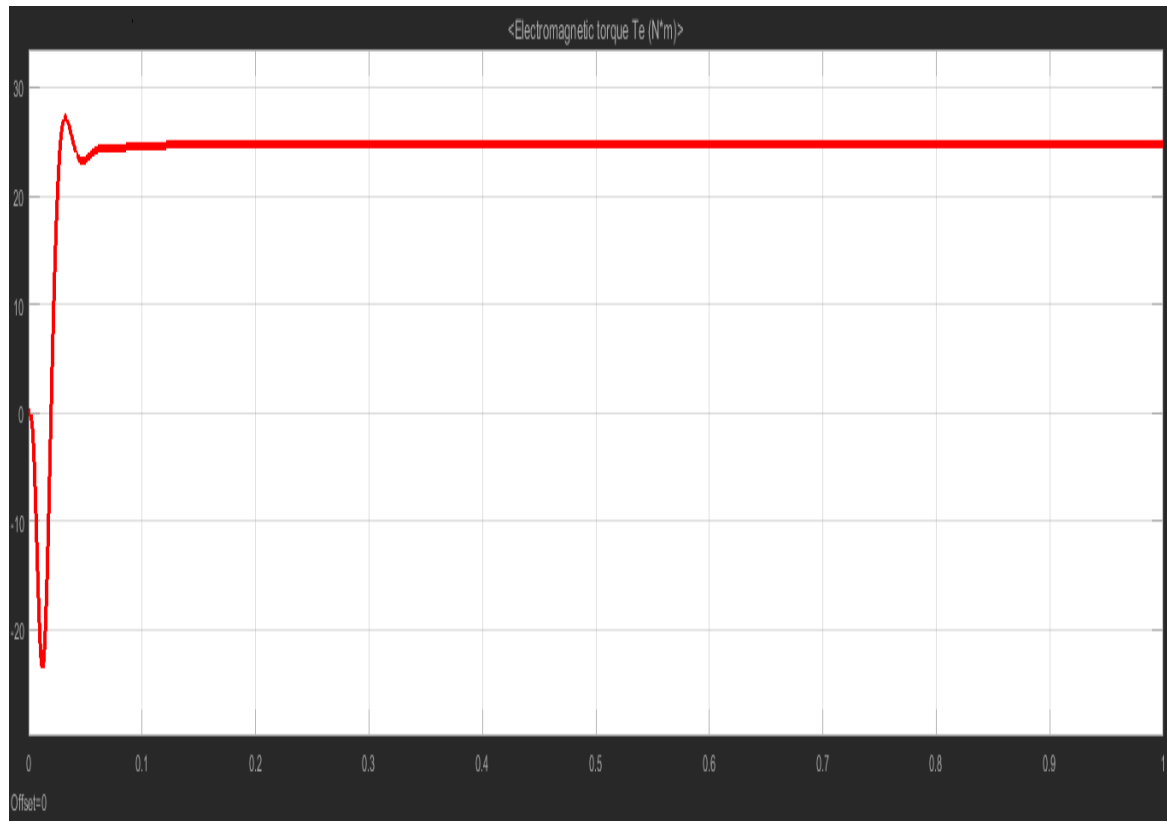

Here the torque at starting was higher but still smaller than the starting torque at 400 volt so also we can note that the changing of line voltage can decrease the starting point too.

The Power as shown :

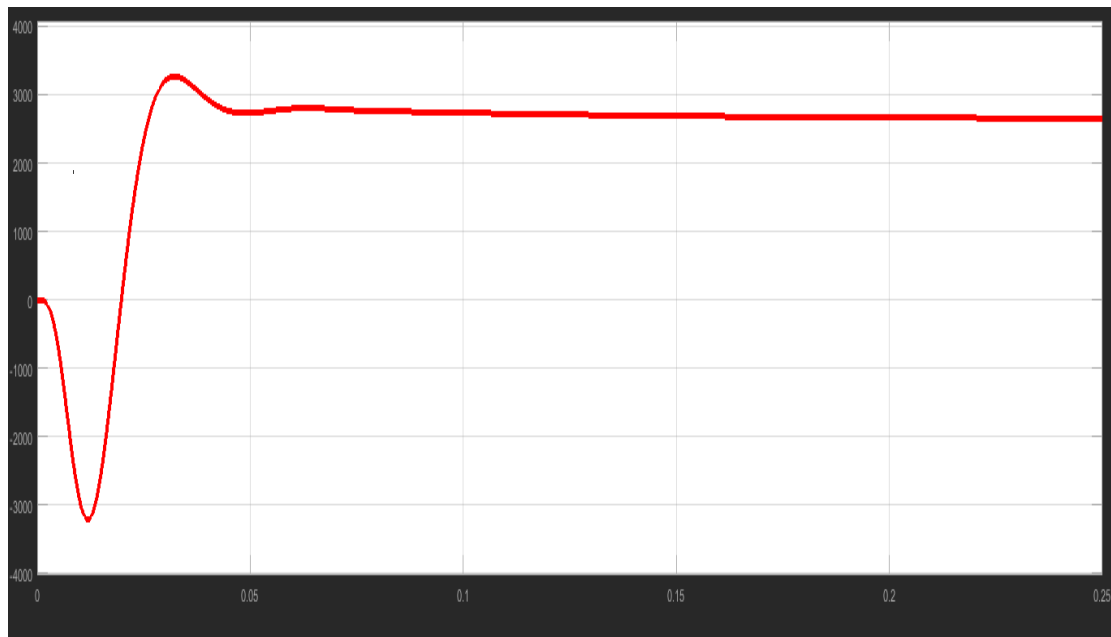

M-file part

This code was written to achieve the torque speed characteristics for the load at 400 volt and the load at 150 volt the plots was written for the torque with the slip and speed as shown in the code below:

Code:

```
Rth=0.738;
Rs = 0.7384;
Xth=0.95013;
Rr=0.7402;
Xr=0.95613;
Xs=0.95613;
Xm=38.9674;
Ws=157;
Vth1=230;
Vth2=86.6;
Tind1=(3*(Vth1.*Vth1).*(Rr./slip))./(Ws.*((Rr./slip)+Rs).*(Rr./slip)+Rs)+((Xr+Xs).*(Xr+Xs)));
Tind2=(3*(Vth2.*Vth2).*(Rr./slip))./(Ws.*((Rr./slip)+Rs).*(Rr./slip)+Rs)+((Xr+Xs).*(Xr+Xs)));
Tload=0.002187.*((1-slip).*Ws).*((1-slip).*Ws);
g=(1-slip).*Ws;
plot((1-slip),Tind1)
xlabel('1-slip ');
ylabel('Torque');
hold on
plot((1-slip),Tload)
```

```

hold on
plot((1-slip),Tind2)
xlabel('1-slip ');
ylabel('Torque');
figure
plot(g,Tind1)
xlabel('speed ');
ylabel('Torque when the input voltage 400');
figure
plot(g,Tind2)
xlabel('speed ');
ylabel('Torque when the input voltage 150');
figure
plot(g,Tind1)
xlabel('speed ');
ylabel('Torque');
hold on
plot(g,Tload)
hold on
plot(g,Tind2)

```

Torque speed characteristics when the load was 400 V

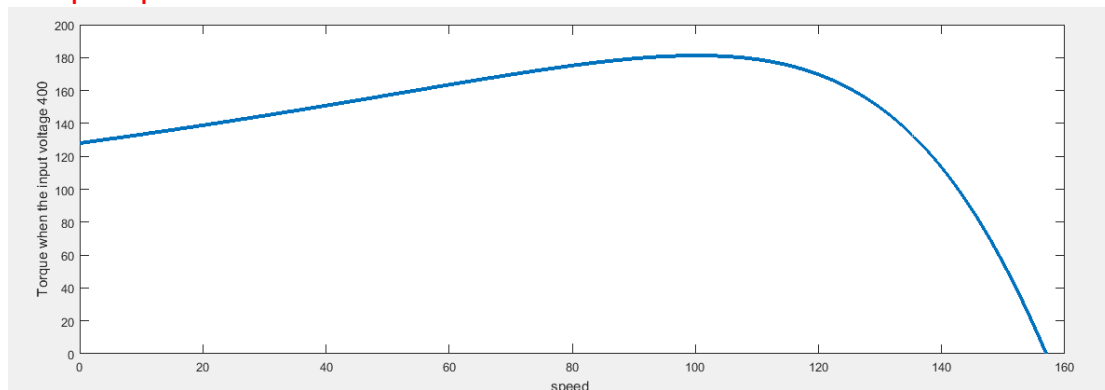

From the figure (torque speed characteristics) we can see the value in slip max and the starting torque for 400 volt input.

Torque speed characteristics when the load was 150 V

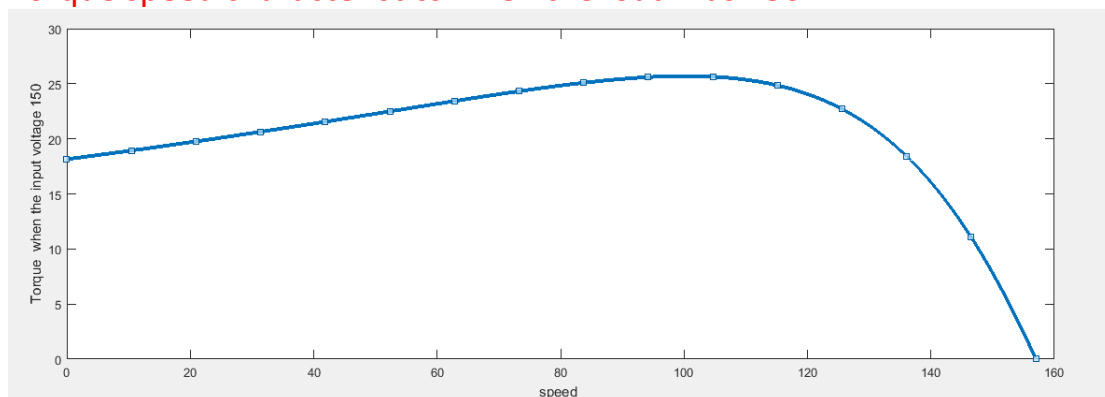

From the figure (torque speed characteristics) we can see the value in slip max and the starting torque for 150 volt input

Torque speed characteristics when the load was 400 V and 150 V

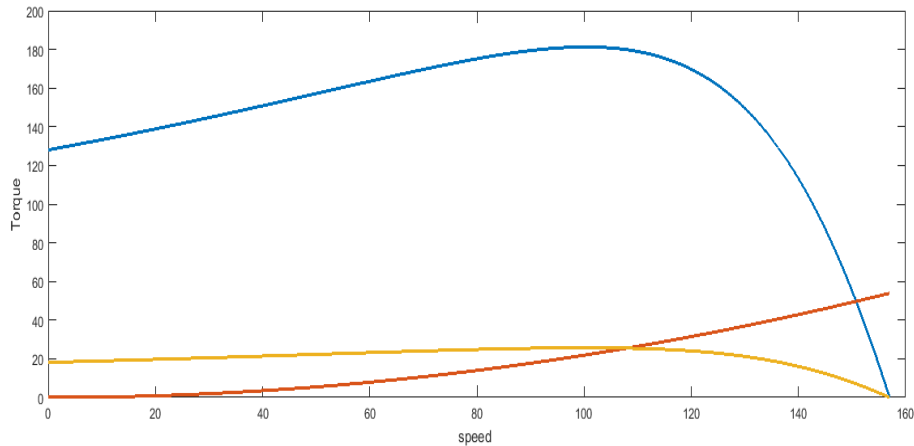

Here the curve (torque speed characteristics) for the two curves of different voltages and the fan load here we can see the mechanical speed (operating point)at the intersection point between two curves ,we can easily note that the speed of (150 volt curve)with the load is smallest than the other curve which is at 400 volt ,that's because of that the changing voltage will change the speed .

Note : the slip max remains constant for two curves .

Torque slip characteristics when the load was 400 V and 150 V

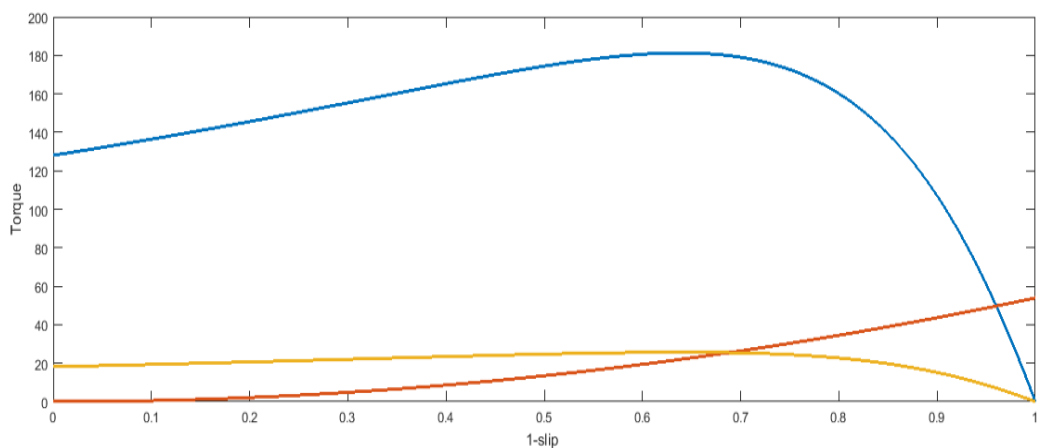

Conclusion

In this assignment, we used the Simulink and M-file in matlab as for the first one we learnt how to build 3- Φ induction motor using the Simulink blocks (SIMPOWER) to get the rotor speed, torque and the power and compare the results of changing the line voltage. And how to get the torque speed characteristics by using matlab M-file. So, we notice that the slip max doesn't change while the changing in the voltage, also, when the voltage decrease the speed will decrease and the starting torque will decrease too.

References

Electrical machines manual, 2019

https://en.wikipedia.org/wiki/Induction_motor