

Simulink Tutorial for Control Applications

1. Starting Simulink:

Type Simulink in the Command Window and press Enter, or click on the Simulink icon as shown

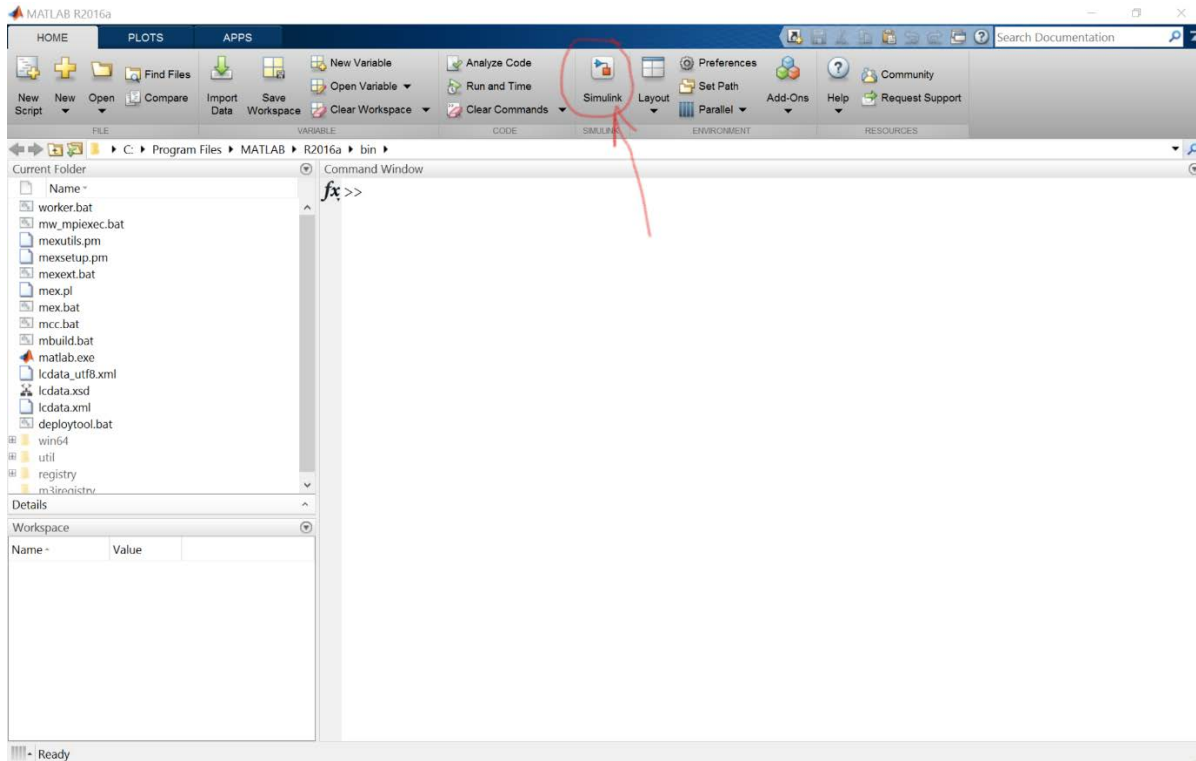

The new model window will open as shown in the figure below:

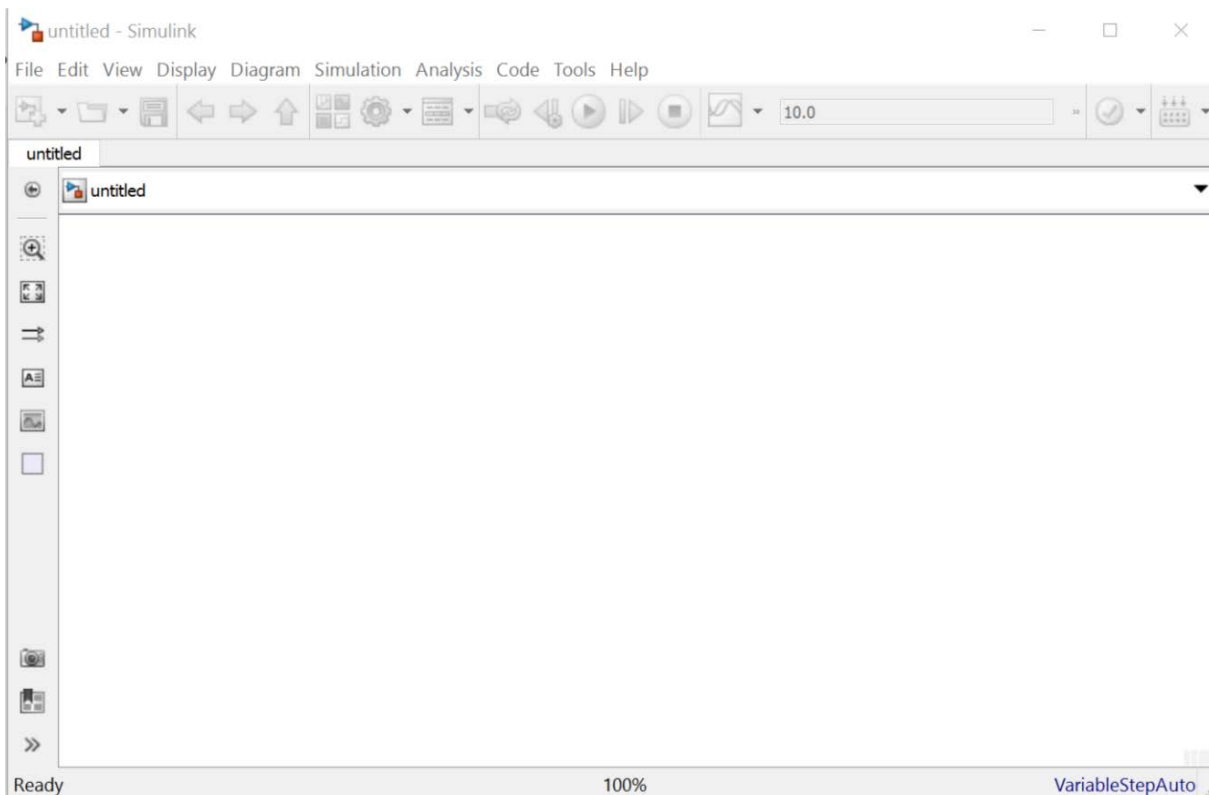

In order to start a new model, you need to open the **Simulink Library Browser** from View → Library Browser, or by typing Ctrl+Shift+L, or by clicking on the corresponding symbol.

This is the library where you find all the blocks you may use in Simulink. Simulink software includes an extensive library of functions commonly used in modeling a system. These include:

- Continuous Dynamic Blocks.
- Discrete Dynamic Blocks.
- Math Blocks.
- Sources.
- Sinks.

The library browser looks like this:

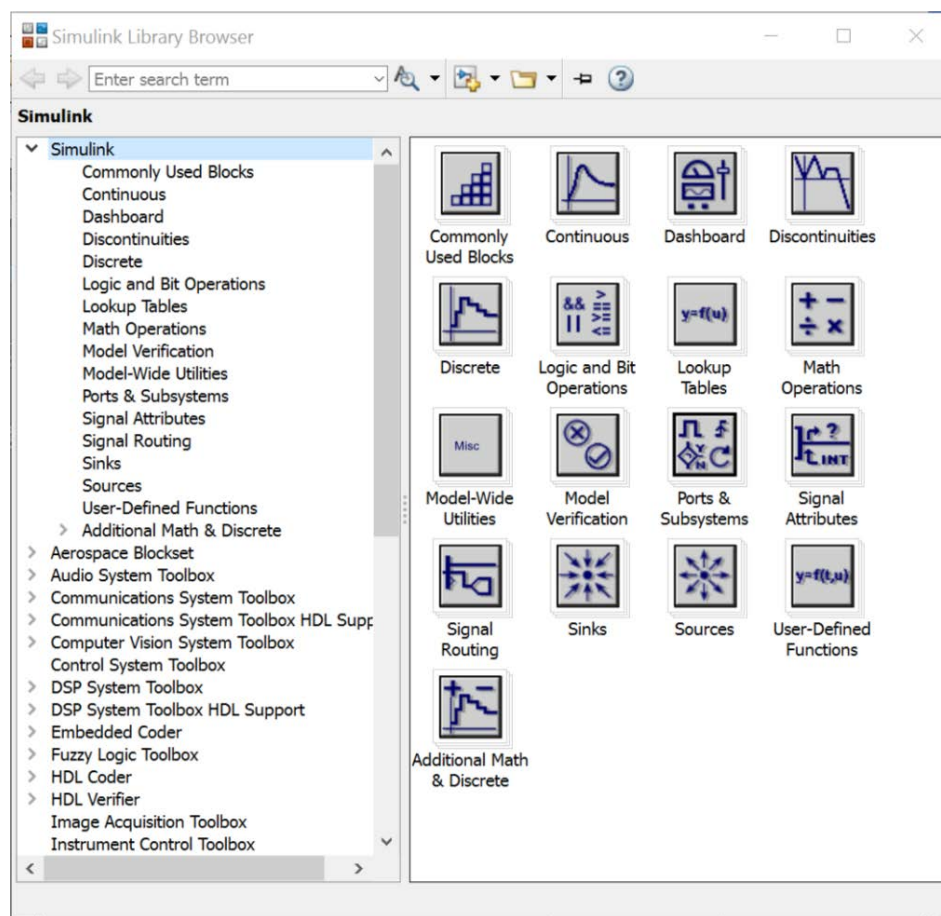

2. Creating a model:

First, you should drag and drop all the blocks you need from the library to the model window.

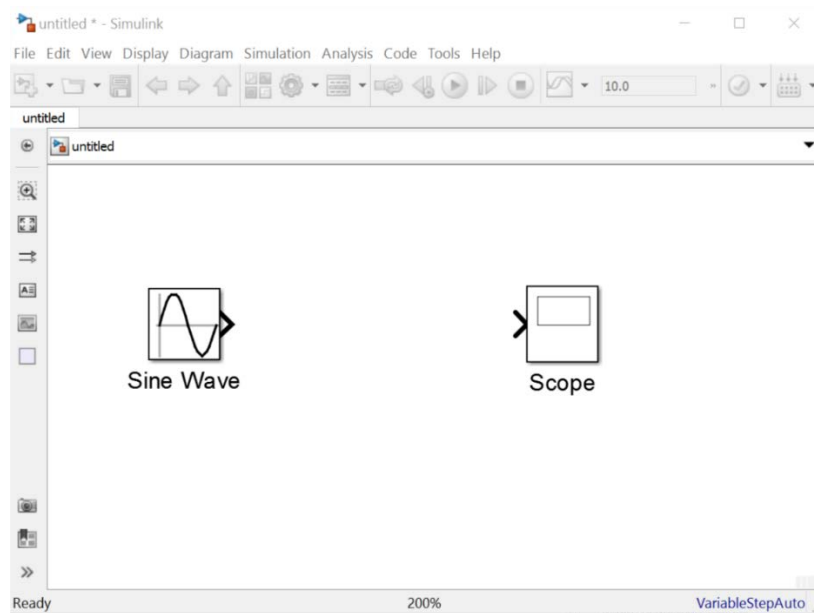

Wiring Techniques:

Inputs are located on the left side of the blocks, while outputs are located on the right hand side of the blocks. Use the mouse to wire outputs of some blocks to inputs of others as required.

If you want to create a pick-off point from some wire, hold down the Ctrl key while clicking on the wire with your mouse.

Simulation:

When you are happy with your model press the Green Play Button to start simulation. When the simulation is done, double click on the sink you used to see results. You can always change the simulation time as needed.

Note that if you double click on a block you can change the properties of that block, or get help regarding that block. Also, if you double click anywhere on the screen you can add comments or change block labels.

3. Some useful features:

- Align blocks.
- Flip blocks.
- Hide names

Example:

This example is simply plotting a sine wave.

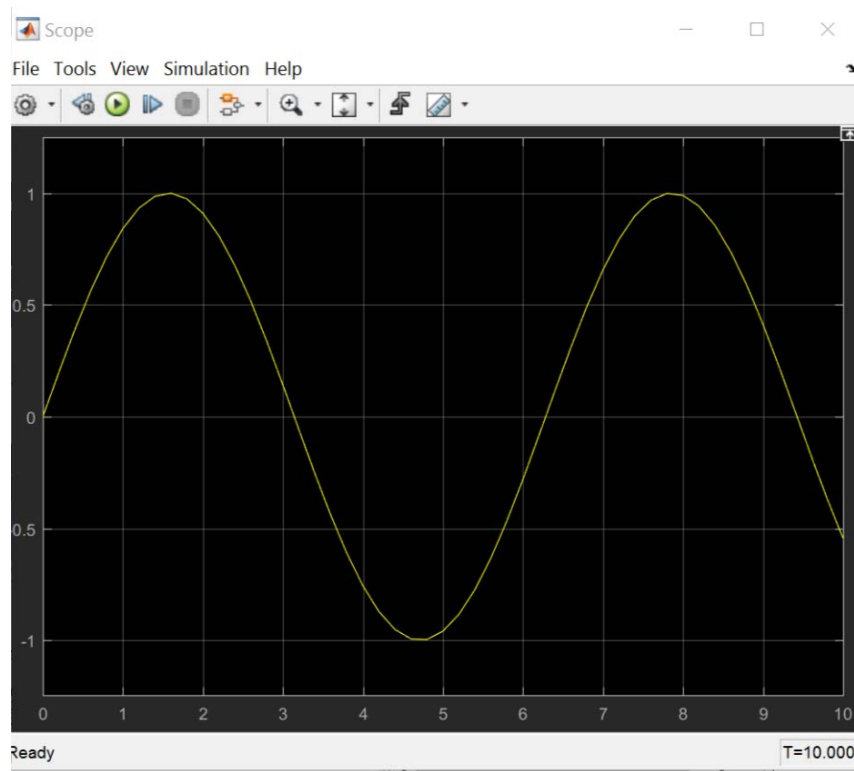
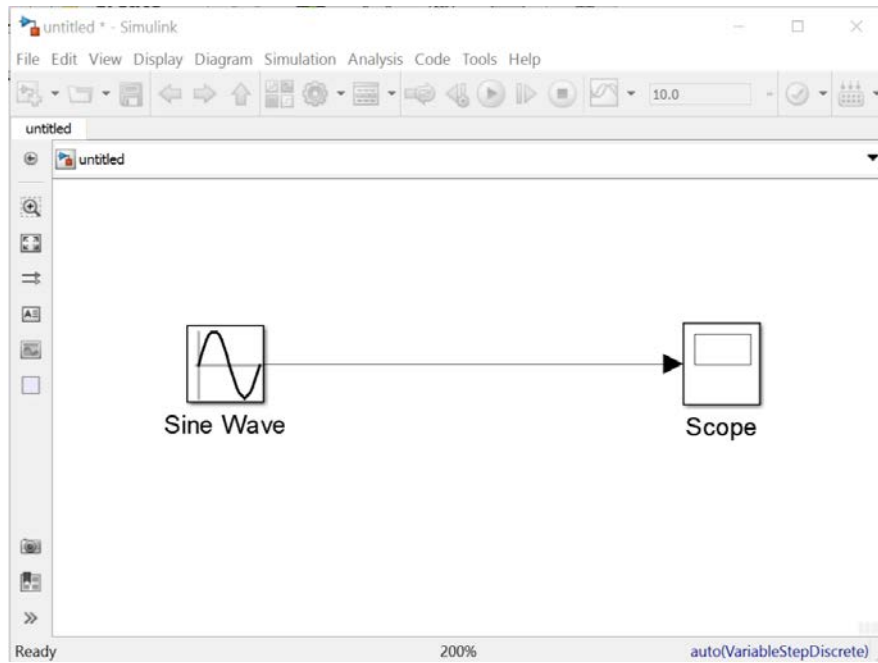

Example: 1 DOF Mass-Spring-Damper System:

$m = 5 \text{ kg}$

$k = 5 \text{ N/m}$

$c = 4 \text{ Ns/m}$

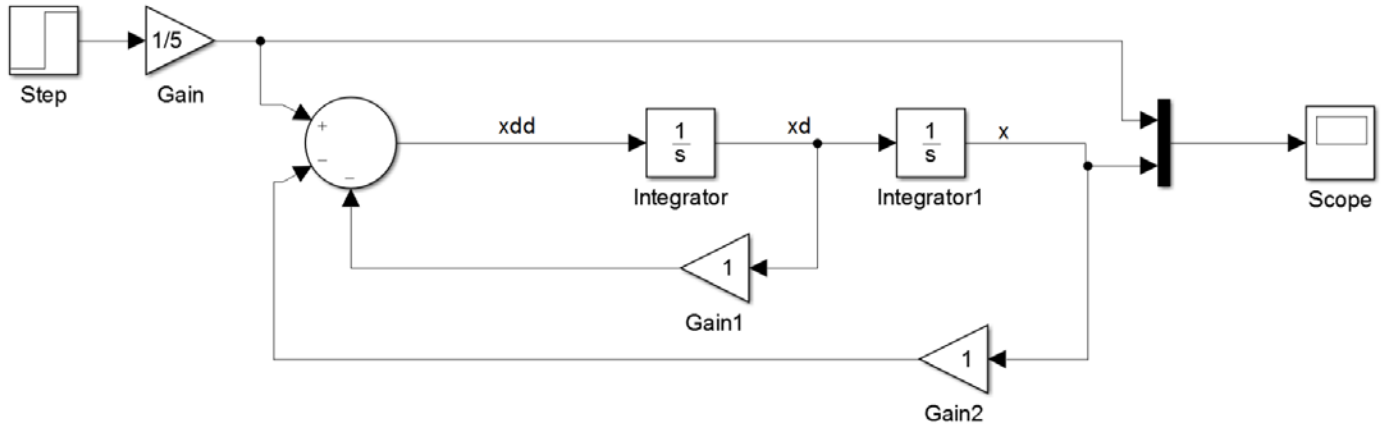

Example: Transfer Function:

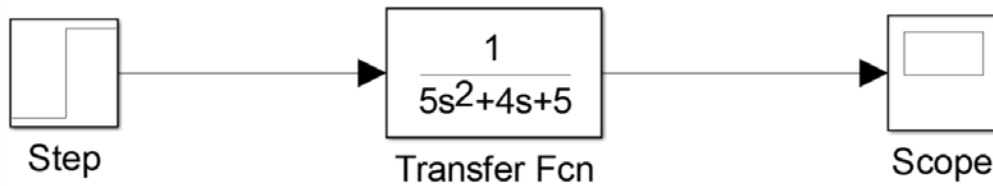

Example: 2 DOF Mass-Spring-Damper System:

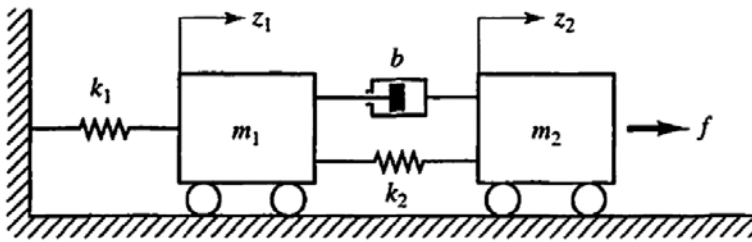

(a)

$M1 = 10 \text{ kg}$

$M2 = 20 \text{ kg}$

$B = 50 \text{ Ns/m}$

$K1 = 30 \text{ N/m}$

$K2 = 60 \text{ N/m}$

