

# Passband Data Transmission

## Introduction

In **baseband pulse transmission**, a data stream represented in the form of a discrete pulse-amplitude modulated (PAM) signal is transmitted over a low-pass channel.

In **digital passband transmission**, the incoming data stream is modulated onto a carrier with fixed frequency and then transmitted over a band-pass channel.

Passband digital transmission allows more efficient use of the allocated RF bandwidth, and flexibility in accommodating different baseband signal formats.

### Example

#### Mobile Telephone Systems

GSM: GMSK modulation is used  
(a variation of FSK)

IS-54:  $\pi/4$ -DQPSK modulation is used  
(a variation of PSK)

The modulation process making the transmission possible involves switching (keying) the amplitude, frequency, or phase of a sinusoidal carrier in accordance with the incoming data.

There are three basic signaling schemes:

Amplitude-shift keying (ASK)

Frequency-shift keying (FSK)

Phase-shift keying (PSK)

Binary data

0 1 1 0 1 0 0 1

**ASK**

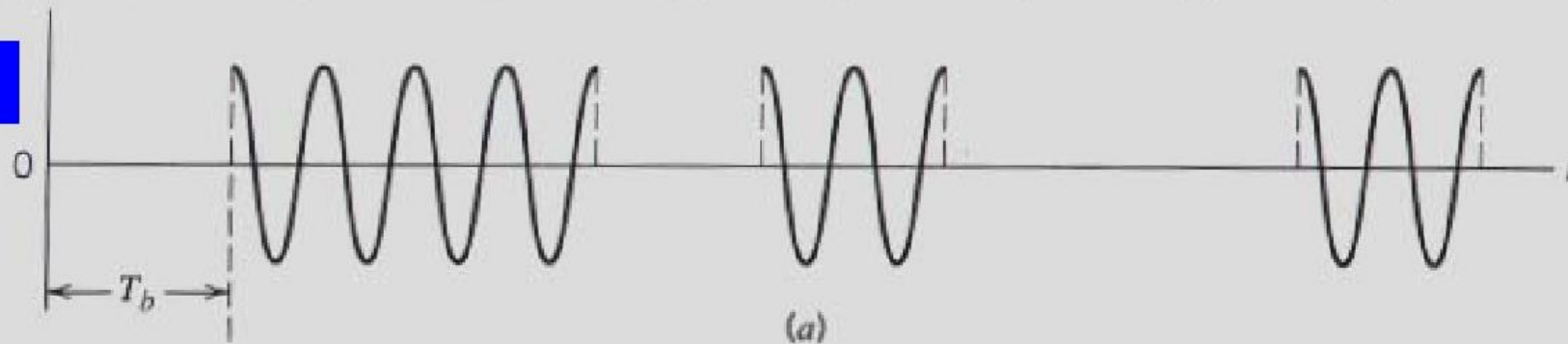

**PSK**

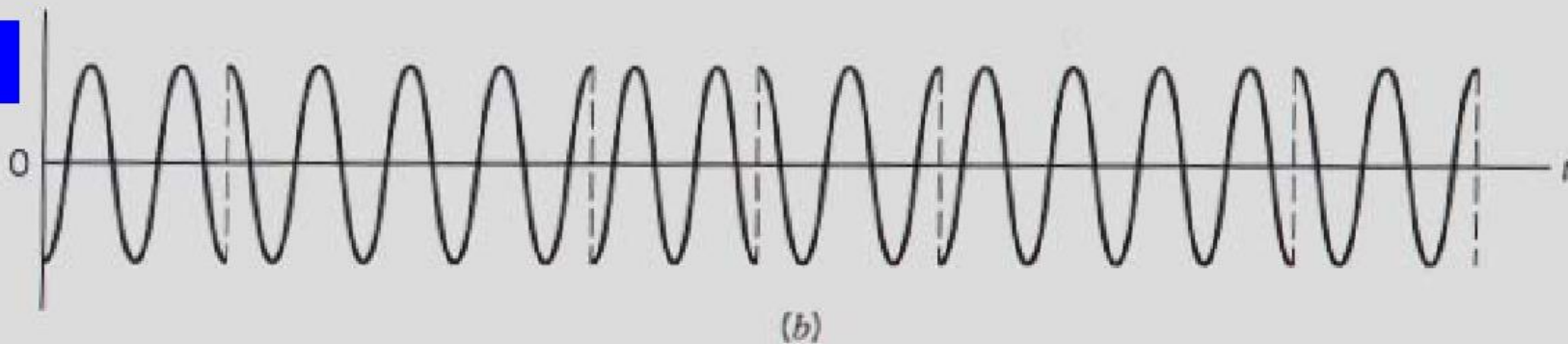

**FSK**

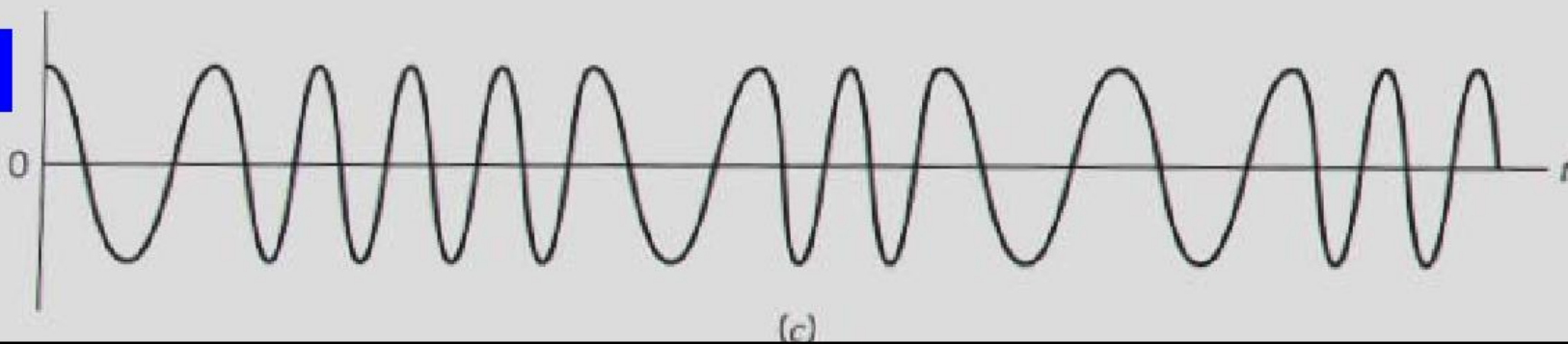

Unlike ASK signals, both PSK and FSK signals have a constant envelope.

PSK and FSK are preferred to ASK signals for passband data transmission over nonlinear channel (amplitude nonlinearities) such as micorwave link and satellite channels.

# Classification of digital modulation techniques

## Coherent and Noncoherent

Digital modulation techniques are classified into coherent and noncoherent techniques, depending on whether the receiver is equipped with a phase-recovery circuit or not.

The phase-recovery circuit ensures that the local oscillator in the receiver is synchronized to the incoming carrier wave (in both frequency and phase).

## Phase Recovery (Carrier Synchronization)

Two ways in which a local oscillator can be synchronized with an incoming carrier wave

- transmit a pilot carrier

- use a carrier-recovery circuit such as a phase-locked loop (PLL)



## M-ary signaling

In an *M*-ary signaling scheme, there are  $M$  possible signals during each signaling interval of duration  $T$ . Usually,  $M = 2^n$  and  $T = nT_b$  where  $T_b$  is the bit duration.

In passband transmission, we have *M*-ary ASK, *M*-ary PSK, and *M*-ary FSK digital modulation schemes.

We can also combine different methods:

*M*-ary amplitude-phase keying (APK)

*M*-ary quadrature-amplitude modulation (QAM)

**In baseband transmission, we have M-ary PAM**

*M*-ary signaling schemes are preferred over binary signaling schemes for transmitting digital information over band-pass channels when the requirement is to conserve bandwidth at the expense of increased power.

The use of *M*-ary signaling enables a reduction in transmission bandwidth by the factor  $n = \log_2 M$  over binary signaling.

## Coherent PSK

The functional model of passband data transmission system is

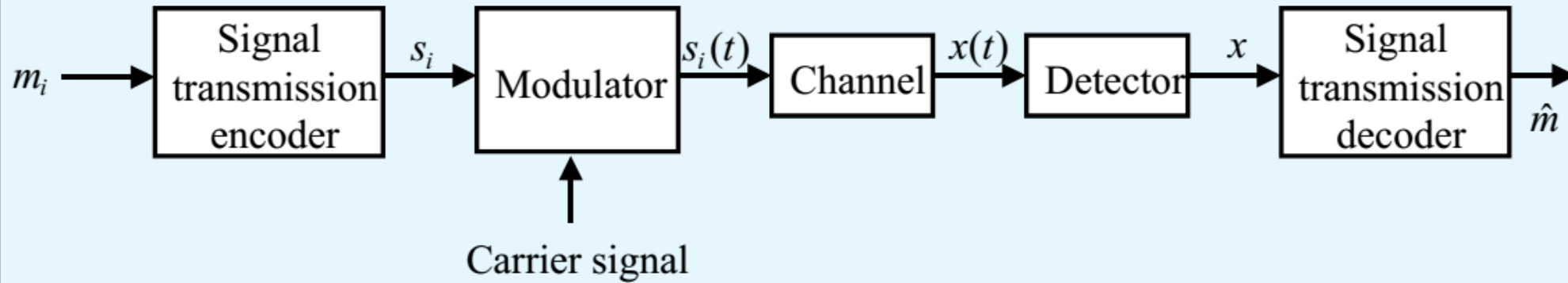

- $m_i$  is a sequence of symbol emitted from a message source.
- The channel is linear, with a bandwidth that is wide enough to transmit the modulated signal and the channel noise is Gaussian distributed with zero mean and power spectral density  $N_o / 2$ .

The following parameters are considered for a signaling scheme:

Probability of error

A major goal of passband data transmission systems is the optimum design of the receiver so as to minimize the average probability of symbol error in the presence of additive white Gaussian noise (AWGN)

## Power spectra

Use to determine the signal bandwidth and co-channel interference in multiplexed systems.

In practice, the signalings are linear operation, therefore, it is sufficient to evaluate the baseband power spectral density.

## Bandwidth Efficiency

$$\text{Bandwidth efficiency } \rho = \frac{R_b}{B} \text{ bits/s/Hz}$$

where  $R_b$  is the data rate and  $B$  is the used channel bandwidth.

In a coherent binary PSK system, the pair of signals  $s_1(t)$  and  $s_2(t)$  used to represent binary symbols 1 and 0, respectively, is defined by

$$s_1(t) = \sqrt{\frac{2E_b}{T_b}} \cos(2\pi f_c t)$$

$$s_2(t) = \sqrt{\frac{2E_b}{T_b}} \cos(2\pi f_c t + \pi) = -\sqrt{\frac{2E_b}{T_b}} \cos(2\pi f_c t)$$

In a coherent binary PSK system, the pair of signals  $s_1(t)$  and  $s_2(t)$  used to represent binary symbols 1 and 0, respectively, is defined by

$$s_1(t) = \sqrt{\frac{2E_b}{T_b}} \cos(2\pi f_c t)$$

$$s_2(t) = \sqrt{\frac{2E_b}{T_b}} \cos(2\pi f_c t + \pi) = -\sqrt{\frac{2E_b}{T_b}} \cos(2\pi f_c t)$$

where  $0 \leq t \leq T_b$ , and  $E_b$  is the transmitted signal energy per bit.

For example,

$$E = \int_0^{T_b} [s_1(t)]^2 dt = \frac{2E_b}{T_b} \int_0^{T_b} \cos^2(2\pi f_c t) dt = \frac{2E_b}{T_b} \cdot \frac{T_b}{2} = E_b$$

To ensure that each transmitted bit contains an integral number of cycles of the carrier wave, the carrier frequency  $f_c$  is chosen equal to  $n/T_b$  for some fixed integer  $n$ .



The transmitted signal can be written as

$$s_1(t) = \sqrt{E_b} \phi(t) \text{ and}$$

$$s_2(t) = -\sqrt{E_b} \phi(t)$$

$$\text{where } \phi(t) = \sqrt{\frac{2}{T_b}} \cos(2\pi f_c t) \quad 0 \leq t < T_b$$

## Generation of coherent binary PSK signals

To generate a binary PSK signal, we have to represent the input binary sequence in polar form with symbols 1 and 0 represented by constant amplitude levels of  $+\sqrt{E_b}$  and  $-\sqrt{E_b}$ , respectively.

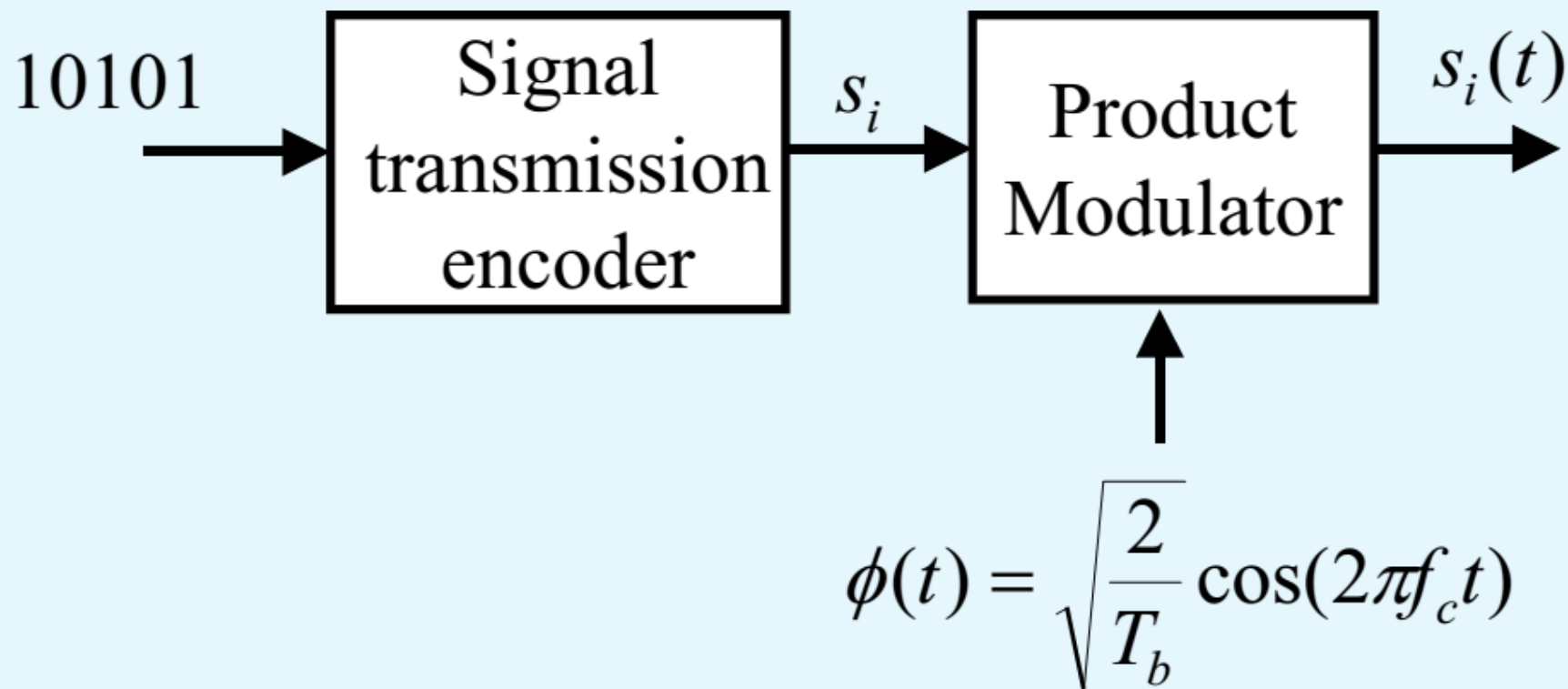

- This signal transmission encoder is performed by a polar nonreturn-to-zero (NRZ) encoder.

$$s_i = \begin{cases} +\sqrt{E_b} & \text{input symbol is 1} \\ -\sqrt{E_b} & \text{input symbol is 0} \end{cases}$$

- The carrier frequency  $f_c = n/T_b$  where  $n$  is a fixed integer.

$$s_i(t) = \begin{cases} s_1(t) = \sqrt{\frac{2E_b}{T_b}} \cos(2\pi f_c t) & \text{if } s_i = \sqrt{E_b} \\ s_2(t) = -\sqrt{\frac{2E_b}{T_b}} \cos(2\pi f_c t) & \text{if } s_i = -\sqrt{E_b} \end{cases}$$

## Detection of coherent binary PSK signals

To detect the original binary sequence of 1s and 0s, we apply the noisy PSK signal to a correlator. The correlator output is compared with a threshold of zero volts.

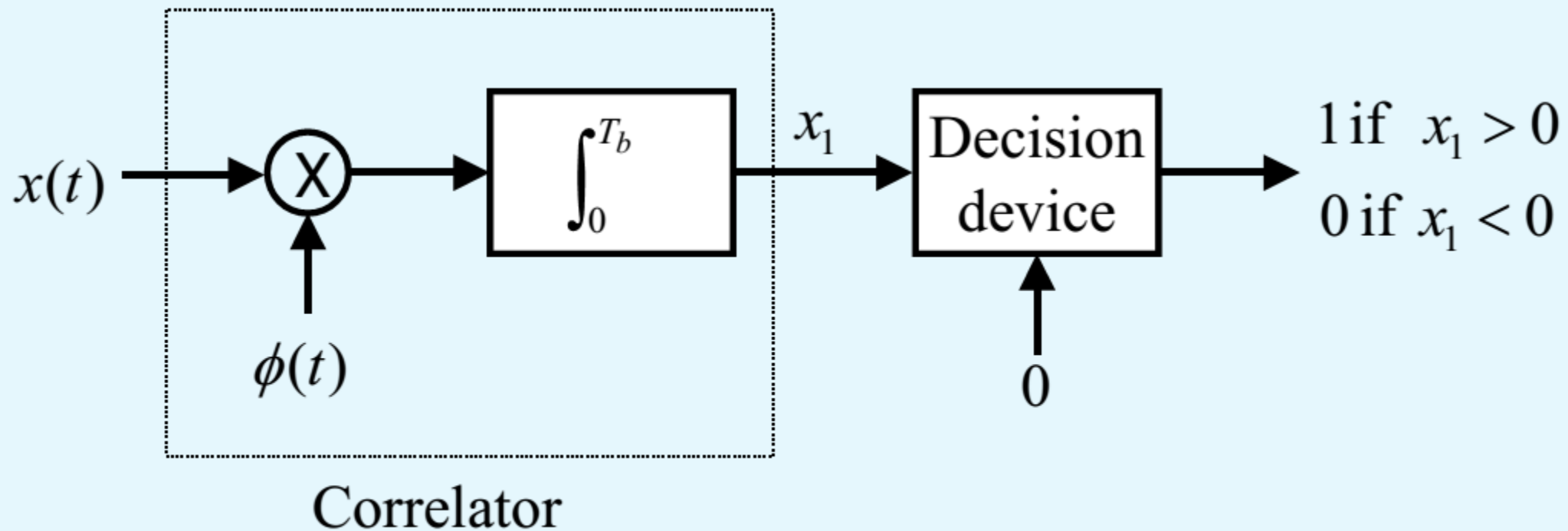

Example: If the transmitted symbol is 1,

$$x(t) = \sqrt{\frac{2E_b}{T_b}} \cos(2\pi f_c t)$$

and the correlator output is

$$\begin{aligned} x_1 &= \int_0^{T_b} x(t)\phi(t)dt \\ &= \int_0^{T_b} \sqrt{\frac{2E_b}{T_b}} \cos(2\pi f_c t) \cdot \sqrt{\frac{2}{T_b}} \cos(2\pi f_c t)dt \\ &= \sqrt{E_b} \cdot \frac{2}{T_b} \int_0^{T_b} \cos^2(2\pi f_c t)dt \\ &= \sqrt{E_b} \end{aligned}$$

Similarly, If the transmitted symbol is 0,  $x_1 = -\sqrt{E_b}$ .

## Error probability of binary PSK

We can represent a coherent binary system with a signal constellation consisting of two message points.

- The coordinates of the message points are all the possible correlator output under a noiseless condition.
- The coordinates for BPSK are  $\sqrt{E_b}$  and  $-\sqrt{E_b}$ .

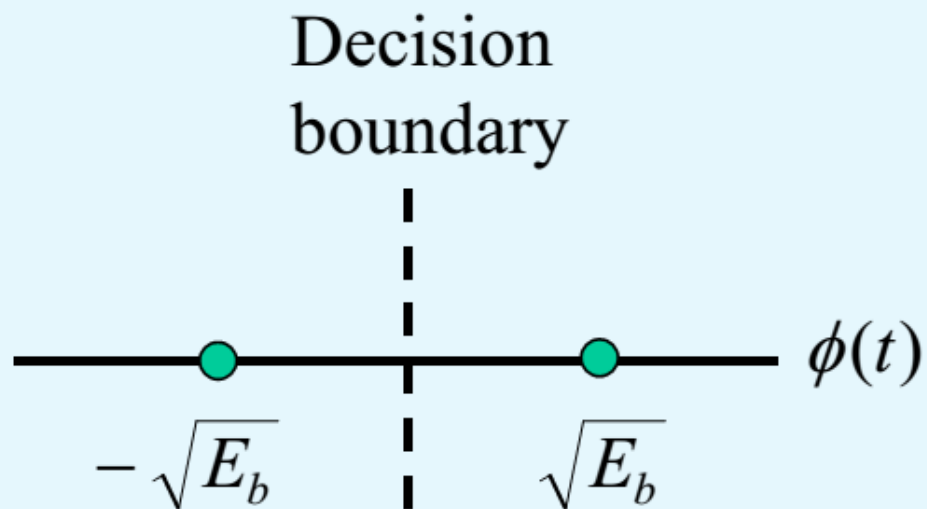

There are two possible kinds of erroneous decision:

- Signal  $s_2(t)$  is transmitted, but the noise is such that the received signal point inside region with  $x_1 > 0$  and so the receiver decides in favor of signal  $s_1(t)$ .
- Signal  $s_1(t)$  is transmitted, but the noise is such that the received signal point inside region with  $x_1 < 0$  and so the receiver decides in favor of signal  $s_2(t)$ .

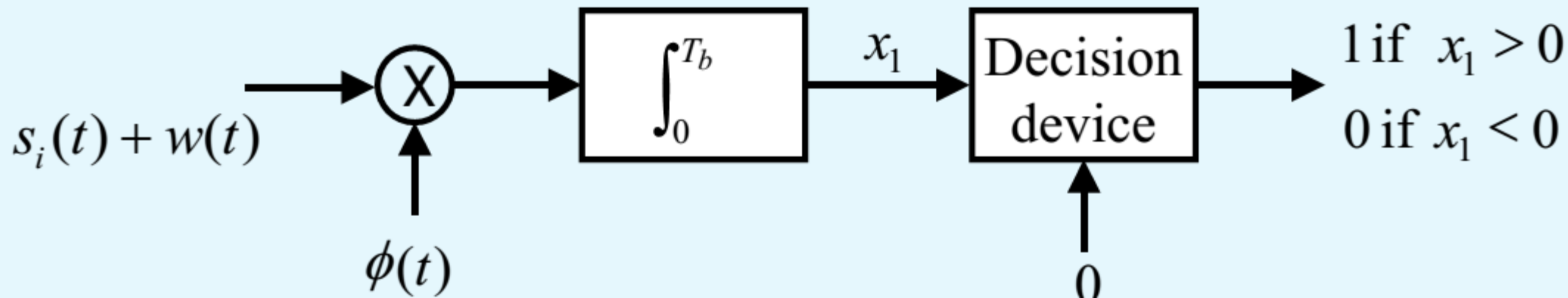

For the first case, the observable element  $x_1$  is related to the received signal  $x(t)$  by

$$\begin{aligned}x_1 &= \int_0^{T_b} x(t)\phi(t)dt \\&= \int_0^{T_b} [s_i(t) + w(t)]\phi(t)dt \\&= -\sqrt{E_b} + \int_0^{T_b} w(t)\phi(t)dt\end{aligned}$$

$x_1$  is a Gaussian process with mean  $\bar{x}_1$  :

$$\begin{aligned}\bar{x}_i &= E[x_i] \\&= E[-\sqrt{E_b} + \int_0^{T_b} w(t)\phi(t)dt] \\&= -\sqrt{E_b}\end{aligned}$$



and variance  $\sigma$  :

$$\begin{aligned}\sigma^2 &= E[(x_i - \bar{x}_i)^2] \\ &= E\left[\left(\int_0^{T_b} w(t)\phi(t)dt\right)^2\right] \\ &= E\left[\int_0^{T_b} \int_0^{T_b} w(t)w(u)\phi(t)\phi(u)dtdu\right] \\ &= \int_0^{T_b} \int_0^{T_b} E[w(t)w(u)]\phi(t)\phi(u)dtdu \\ &= \int_0^{T_b} \int_0^{T_b} \frac{N_o}{2} \delta(t-u)\phi(t)\phi(u)dtdu \\ &= \frac{N_o}{2} \int_0^{T_b} \phi^2(t)dt \\ &= \frac{N_o}{2}\end{aligned}$$

Therefore, the conditional probability density function of  $x_1$ , given that symbol 0 was transmitted is

$$\begin{aligned} f(x_1 | 0) &= \frac{1}{\sqrt{2\pi}\sigma} \exp\left[-\frac{(x_1 - \bar{x}_1)^2}{2\sigma^2}\right] \\ &= \frac{1}{\sqrt{\pi N_o}} \exp\left[-\frac{(x_1 + \sqrt{E_b})^2}{N_o}\right] \end{aligned}$$

and the probability of error is

$$\begin{aligned} p_{10} &= \int_0^{\infty} f(x_1 | 0) dx_1 \\ &= \frac{1}{\sqrt{\pi N_o}} \int_0^{\infty} \exp\left[-\frac{(x_1 + \sqrt{E_b})^2}{N_o}\right] dx_1 \end{aligned}$$

Putting  $z = \frac{1}{\sqrt{N_o}}(x + \sqrt{E_b})$ , we have

$$\begin{aligned} p_{10} &= \frac{1}{\sqrt{\pi}} \int_{\sqrt{E_b/N_o}}^{\infty} \exp[-z^2] dz \\ &= \frac{1}{2} \operatorname{erfc}\left(\sqrt{\frac{E_b}{N_o}}\right) \end{aligned}$$

$$\operatorname{erfc}(u) = \frac{2}{\sqrt{\pi}} \int_u^{\infty} \exp(-z^2) dz$$

Similarly, the error of the second kind

$$p_{01} = p_{10} = \frac{1}{2} \operatorname{erfc} \left( \sqrt{\frac{E_b}{N_o}} \right) \text{ and hence}$$

$$p_e = \frac{1}{2} \operatorname{erfc} \left( \sqrt{\frac{E_b}{N_o}} \right)$$

## Quadrature-phase-shift keying (QPSK)

QPSK has twice the bandwidth efficiency of BPSK, since 2 bits are transmitted in a single modulation symbol. The data input  $d_k(t)$  is divided into an in-phase stream  $d_I(t)$ , and a quadrature stream  $d_Q(t)$ .

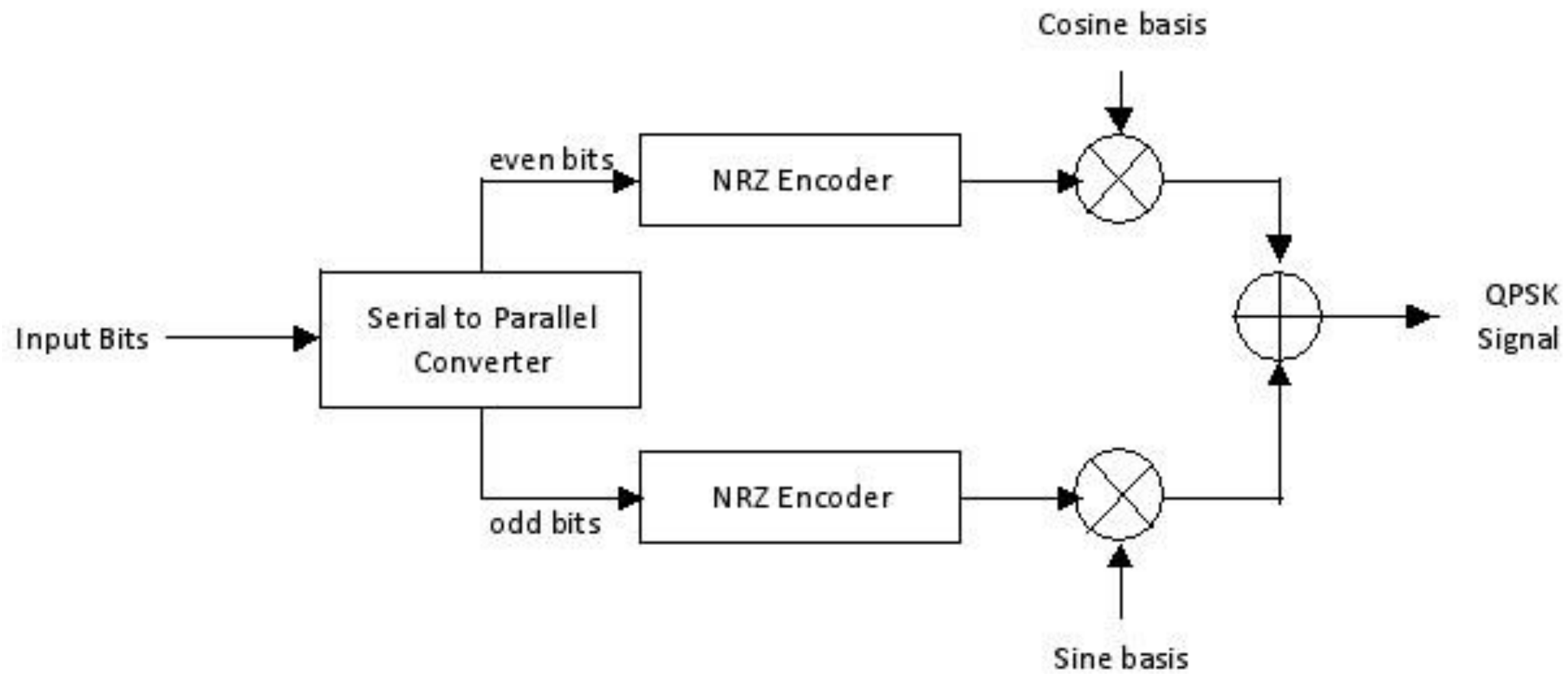

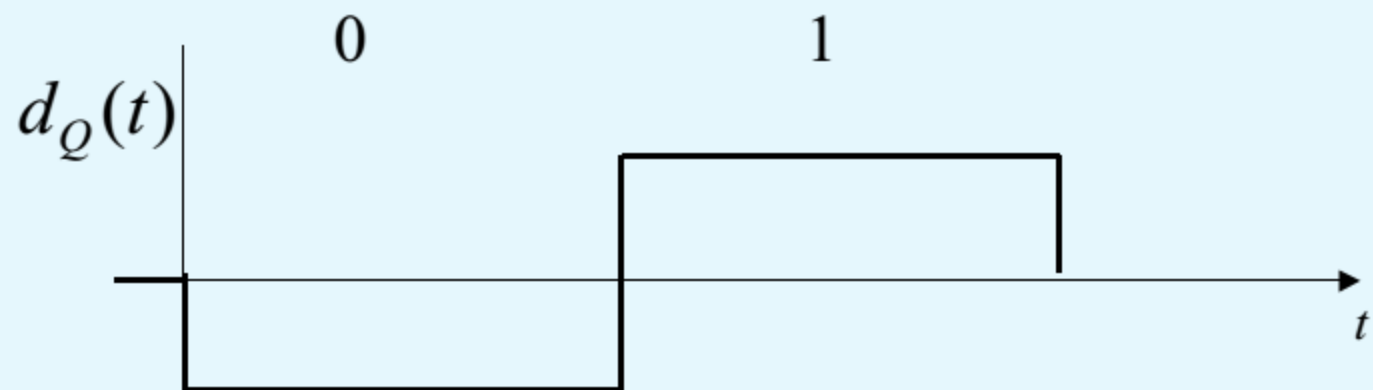
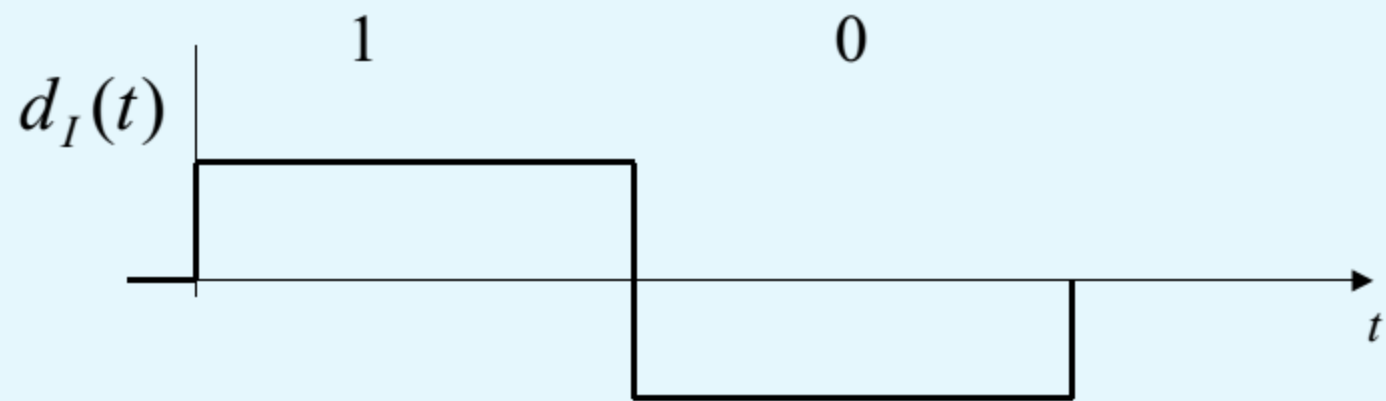
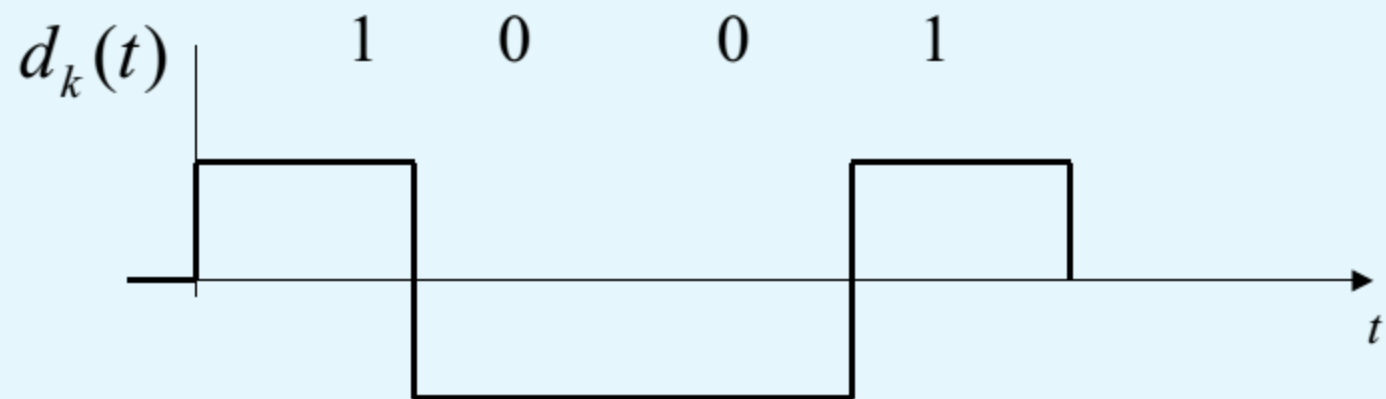

The phase of the carrier takes on one of four equally spaced values, such as  $\pi/4$ ,  $3\pi/4$ ,  $5\pi/4$ , and  $7\pi/4$ .

$$s_i(t) = \begin{cases} \sqrt{\frac{2E}{T}} \cos[2\pi f_c t + (2i-1)\pi/4] & 0 \leq t \leq T \\ 0 & \text{elsewhere} \end{cases}$$

where  $i = 1, 2, 3, 4$ .

$E$  is the transmitted signal energy per symbol;

$T$  is the symbol duration;

$f_c = n/T$ ;

(Note :  $T = 2T_b$  )



Each possible value of the phase corresponds to a unique dibit.

For example, 10 for  $i=1$ , 00 for  $i=2$ , 01 for  $i=3$  and 11 for  $i=4$ .

(only a single bit is change from one dibit to the next)

The transmitted signal can be written as

$$\begin{aligned} s_i(t) &= \sqrt{\frac{2E}{T}} \cos[2\pi f_c t + (2i - 1)\pi / 4] \\ &= \sqrt{\frac{2E}{T}} \cos[2\pi f_c t] \cos[(2i - 1)\pi / 4] \\ &\quad - \sqrt{\frac{2E}{T}} \sin[2\pi f_c t] \sin[(2i - 1)\pi / 4] \\ &= s_{i1} \phi_1(t) + s_{i2} \phi_2(t) \end{aligned}$$

where

$$\phi_1(t) = \sqrt{\frac{2}{T}} \cos[2\pi f_c t]; \quad \phi_2(t) = \sqrt{\frac{2}{T}} \sin[2\pi f_c t]$$

Input dibit	Phase of QPSK	$s_{i1}$	$s_{i2}$
10	$\pi/4$	$\sqrt{E/2}$	$-\sqrt{E/2}$
00	$3\pi/4$	$-\sqrt{E/2}$	$-\sqrt{E/2}$
01	$5\pi/4$	$-\sqrt{E/2}$	$\sqrt{E/2}$
11	$7\pi/4$	$\sqrt{E/2}$	$\sqrt{E/2}$

Input binary sequence

0	1	1	0	1	0	0	0
Dibit 01		Dibit 10		Dibit 10		Dibit 00	

(a)

Odd-numbered sequence 0 1 1 0  
 Polarity of coefficient  $s_{i1}$  - + + -

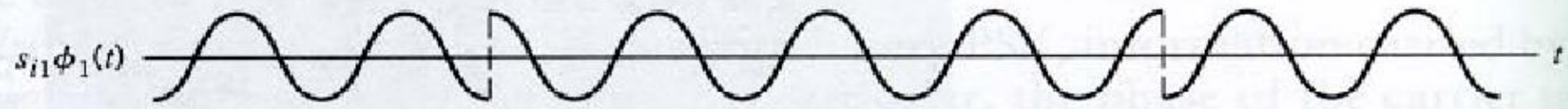

(b)

Even-numbered sequence 1 0 0 0  
 Polarity of coefficient  $s_{i2}$  + - - -

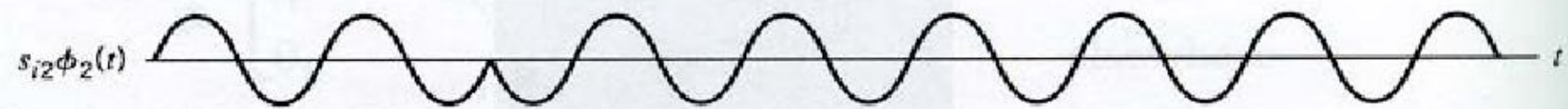

(c)

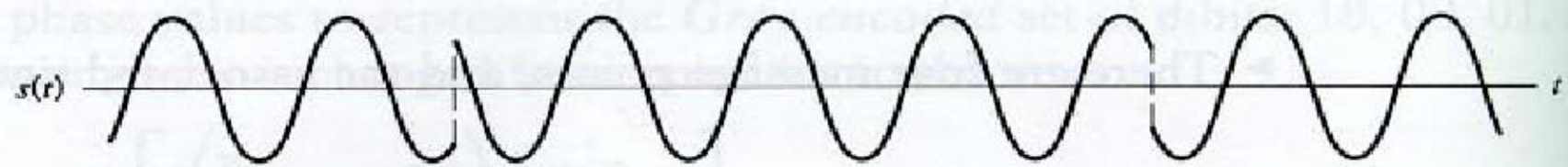

(d)

The constellation of QPSK is

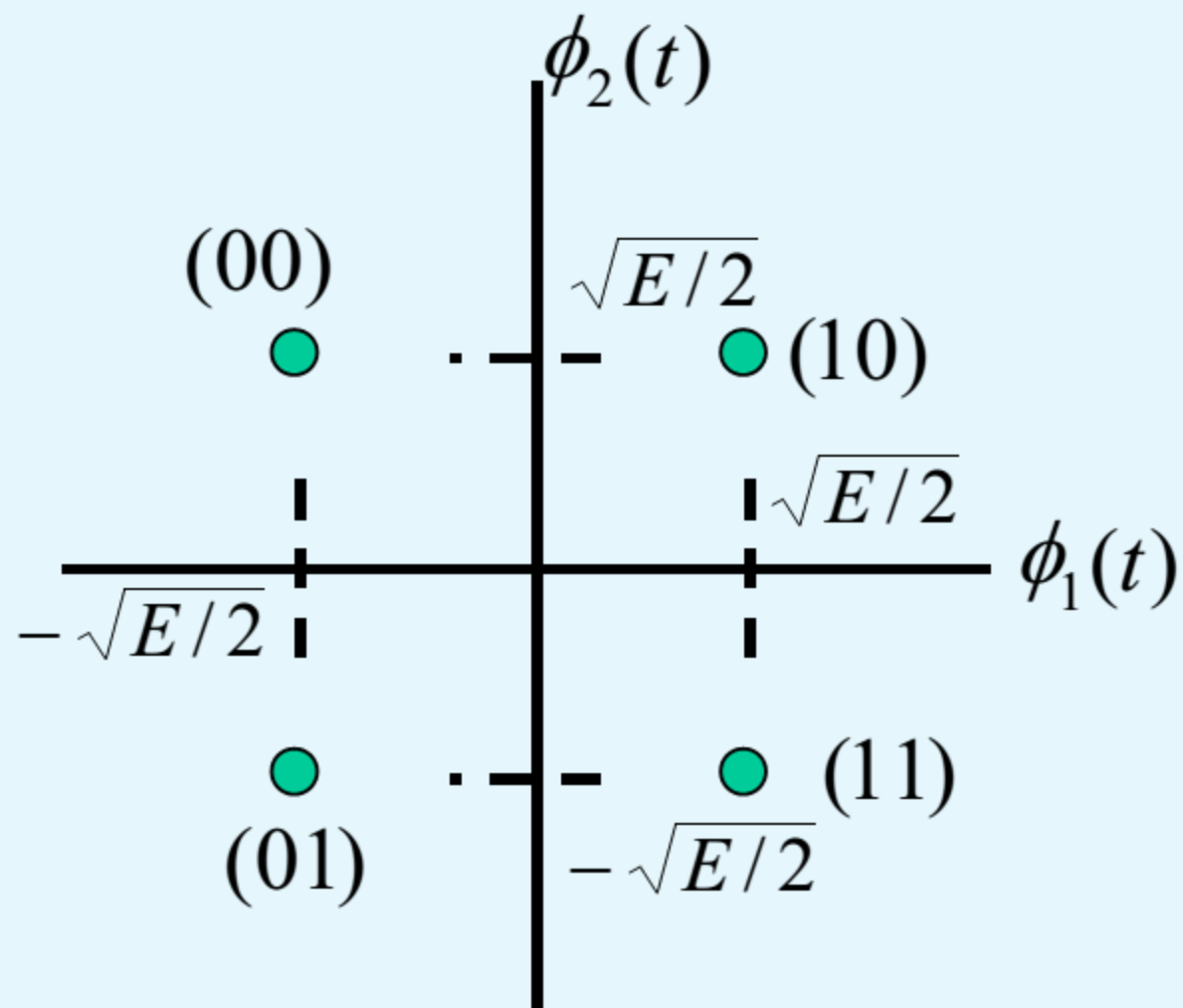

## Generation of coherent QPSK signals

The incoming binary data sequence is first transformed into polar form by a nonreturn-to-zero level encoder. The binary wave is next divided by means of a demultiplexer into two separate binary sequences.

The result can be regarded as a pair of binary PSK signals, which may be detected independently due to the orthogonality of  $\phi_1(t)$  and  $\phi_2(t)$ .

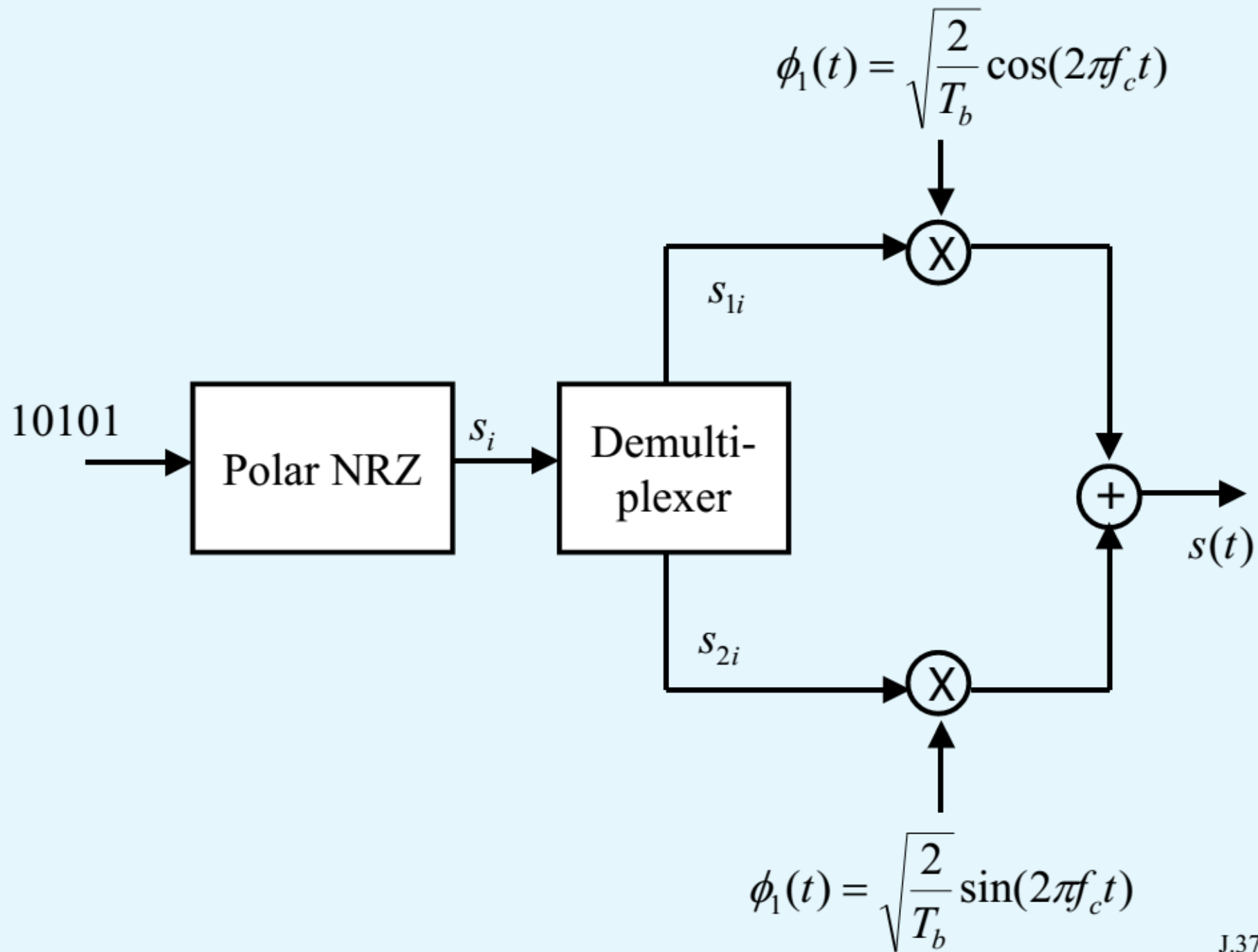

## Detection of coherent QPSK signals

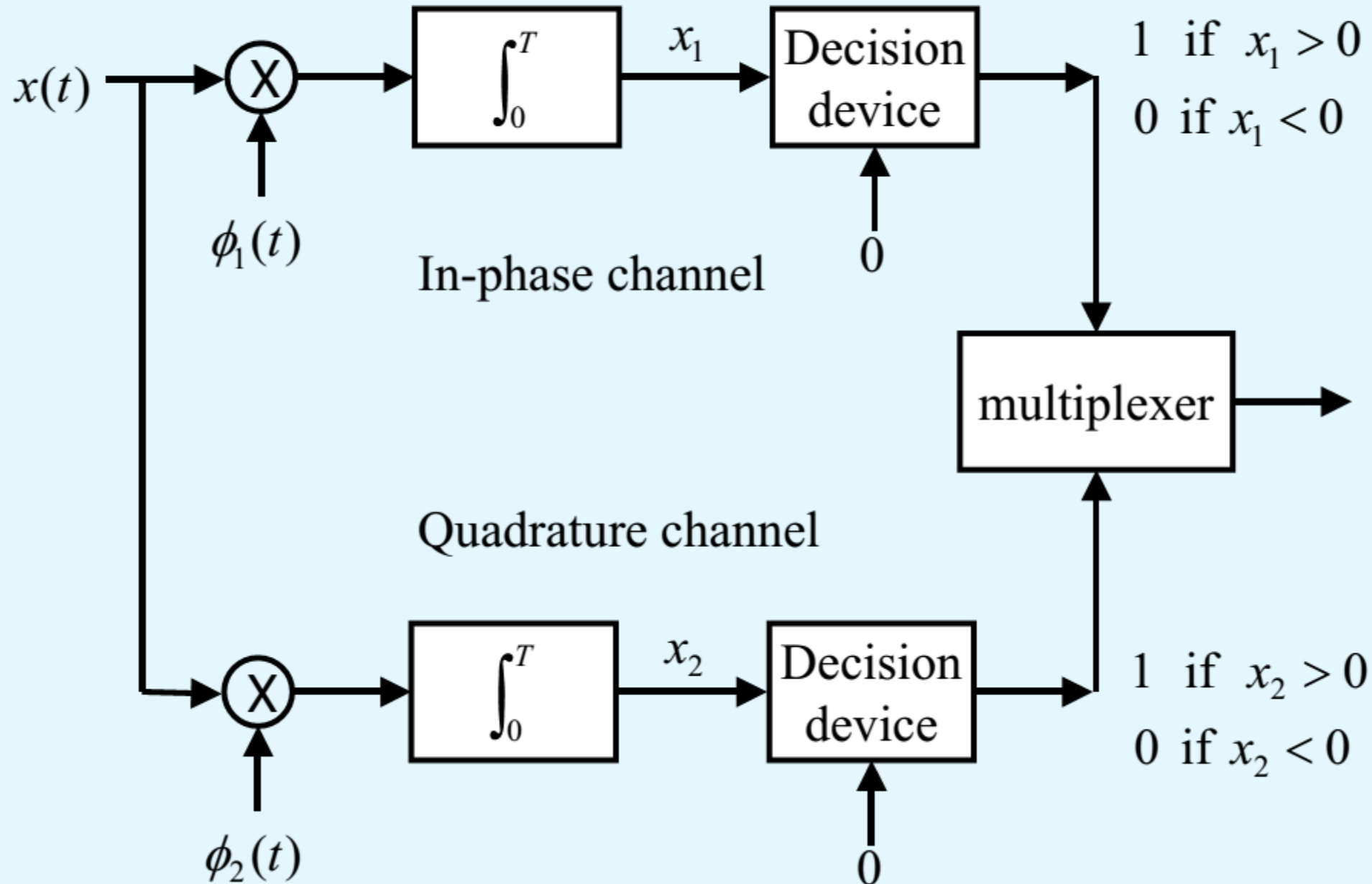



## Error probability of QPSK

The received signal is

$$x(t) = s_i(t) + w(t)$$

and the observation elements are

$$\begin{aligned}x_1 &= \int_0^{T_b} x(t)\phi_1(t)dt \\ &= \pm\sqrt{E_b} + \int_0^{T_b} w(t)\phi_1(t)dt \\ x_2 &= \int_0^{T_b} x(t)\phi_2(t)dt \\ &= \pm\sqrt{E_b} + \int_0^{T_b} w(t)\phi_2(t)dt\end{aligned}$$

As a coherent QPSK is equivalent to two coherent binary PSK systems working in parallel and using two carriers that are in phase quadrature.

Hence, the average probability of **bit error in each channel** of the coherent QPSK system is

$$p = \frac{1}{2} \operatorname{erfc} \left( \sqrt{\frac{E/2}{N_o}} \right) = \frac{1}{2} \operatorname{erfc} \left( \sqrt{\frac{E}{2N_o}} \right)$$

## Error probability of QPSK

As the bit error in the in-phase and quadrature channels of the coherent QPSK system are statistically independent, the average probability of a correct decision resulting from the combined action of the two channels is

$$\begin{aligned} p_c &= (1 - p)^2 \\ &= \left[ 1 - \frac{1}{2} \operatorname{erfc} \left( \sqrt{\frac{E}{2N_o}} \right) \right]^2 \\ &= 1 - \operatorname{erfc} \left( \sqrt{\frac{E}{2N_o}} \right) + \frac{1}{4} \operatorname{erfc}^2 \left( \sqrt{\frac{E}{2N_o}} \right) \end{aligned}$$

The average probability of **symbol error** for coherent QPSK is therefore

$$\begin{aligned} p_e &= 1 - p_c \\ &= \operatorname{erfc}\left(\sqrt{\frac{E}{2N_o}}\right) - \frac{1}{4} \operatorname{erfc}^2\left(\sqrt{\frac{E}{2N_o}}\right) \\ &\approx \operatorname{erfc}\left(\sqrt{\frac{E}{2N_o}}\right) \quad \text{if } E/2N_o \gg 1 \end{aligned}$$

In a QPSK system, since there are two bits per symbol, the transmitted signal energy per symbol is twice the signal energy per bit,

$$E = 2E_b$$

and then

$$p_e \approx \text{erfc}\left(\sqrt{\frac{E_b}{N_o}}\right)$$

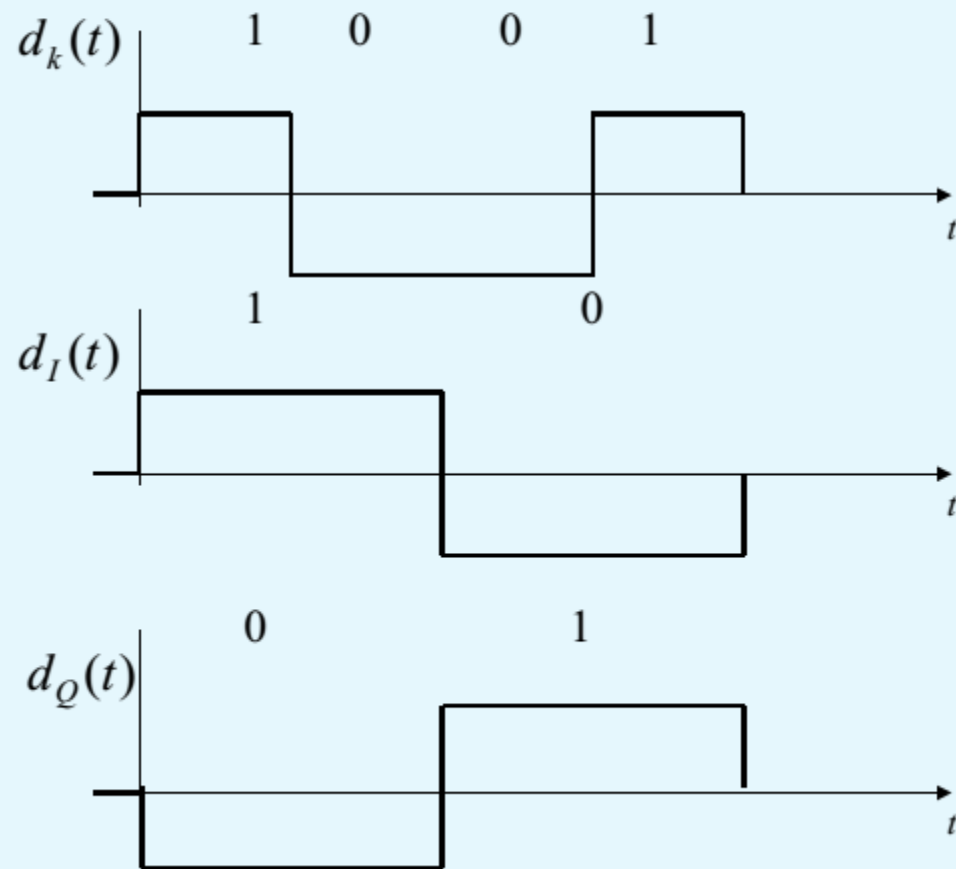

With Gray encoding, the bit error rate of QPSK is

$$\text{BER} = \frac{1}{2} \text{erfc} \left( \sqrt{\frac{E_b}{N_o}} \right)$$

Therefore, a coherent QPSK system achieves the same average probability of bit error as a coherent binary PSK system for the same bit rate and the same  $E_b / N_o$  but uses only half the channel bandwidth.

## M-ary PSK

During each signaling interval of duration  $T$ , one of the  $M$  possible signals

$$s_i(t) = \sqrt{\frac{2E}{T}} \cos\left(2\pi f_c t + \frac{2\pi}{M}(i-1)\right) \quad i = 1, 2, \dots,$$

is sent.

## M-ary PSK

The signal constellation of  $M$ -ary PSK consists of  $M$  message points which are equally spaced on a circle of radius  $\sqrt{E}$ . For example, the constellation of octaphase-shift keying is

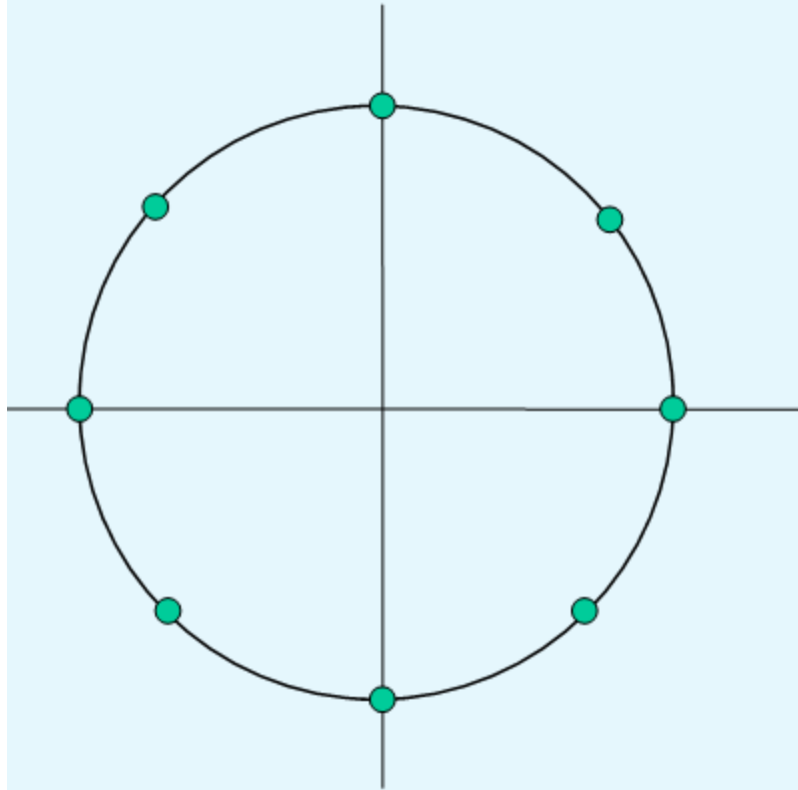

$$P_e \approx \operatorname{erfc} \left( \sqrt{\frac{E}{N_o}} \sin \left( \frac{\pi}{M} \right) \right)$$

$$M \geq 4$$



## Power spectra of M-ary PSK signals

The symbol function is

$$g(t) = \begin{cases} \sqrt{\frac{2E}{T}} & 0 \leq t \leq T \\ 0 & \text{otherwise} \end{cases}$$

where  $T = T_b \log_2 M$  and  $T_b$  is the bit duration.

As the energy spectral density is the magnitude of the signal's Fourier transform, the baseband power spectral density is

$$\begin{aligned} S(f) &= 2E \frac{\sin^2(\pi T f)}{(\pi T f)^2} \\ &= 2E_b \log_2 M \operatorname{sinc}^2(T_b f \log_2 M) \end{aligned}$$

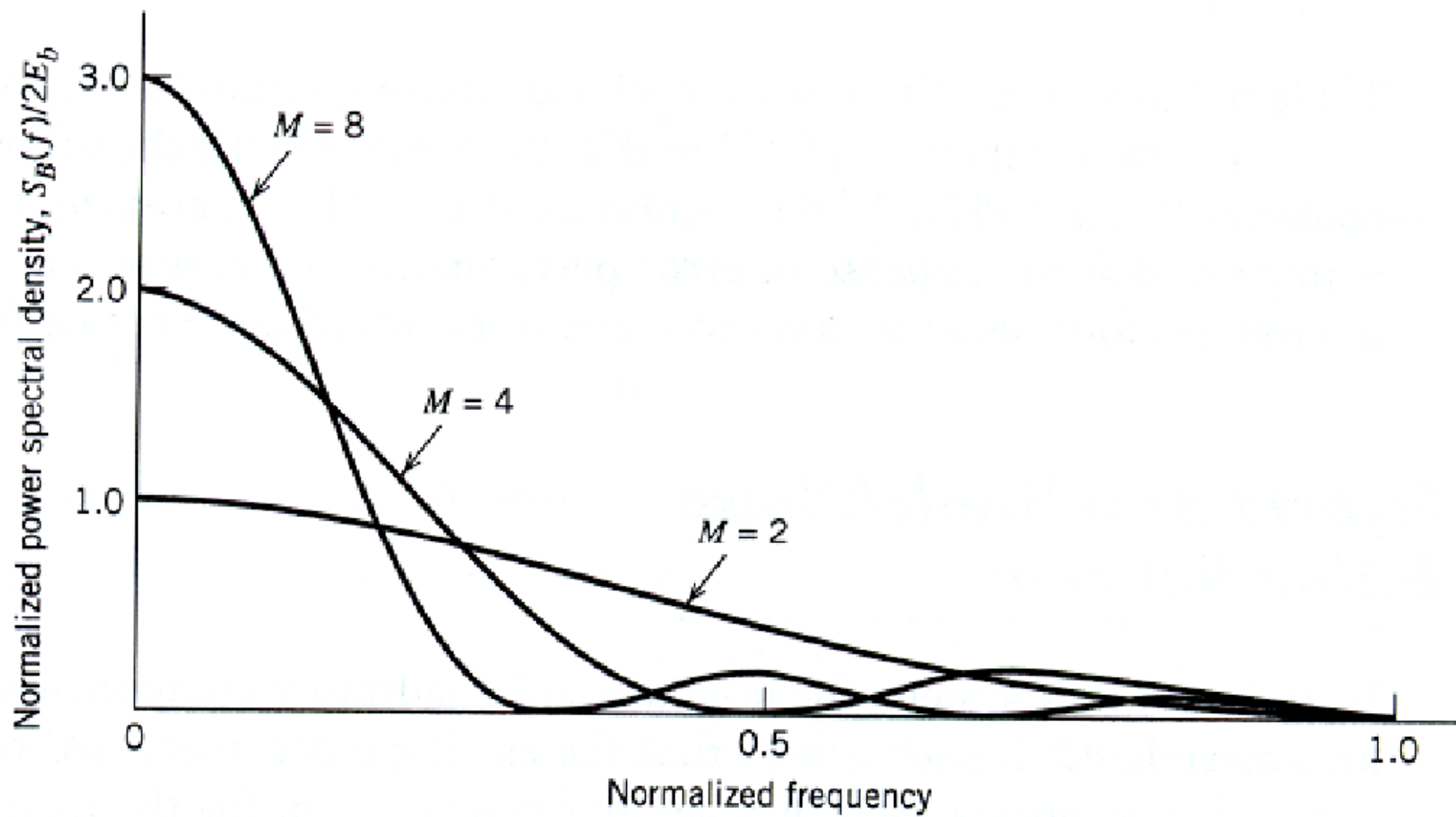

(Normalized to  $fT_b$ )

## Bandwidth efficiency

The bandwidth required to pass M-ary signal (main lobe) is given by

$$B = \frac{2}{T} \quad \because \text{sinc}(2) = 0$$

$$= \frac{2}{T_b \log_2 M}$$

$$= \frac{2R_b}{\log_2 M}$$

Therefore, the bandwidth efficiency is

$$\begin{aligned} \rho &= \frac{R_b}{B} \\ &= \frac{\log_2 M}{2} \end{aligned}$$