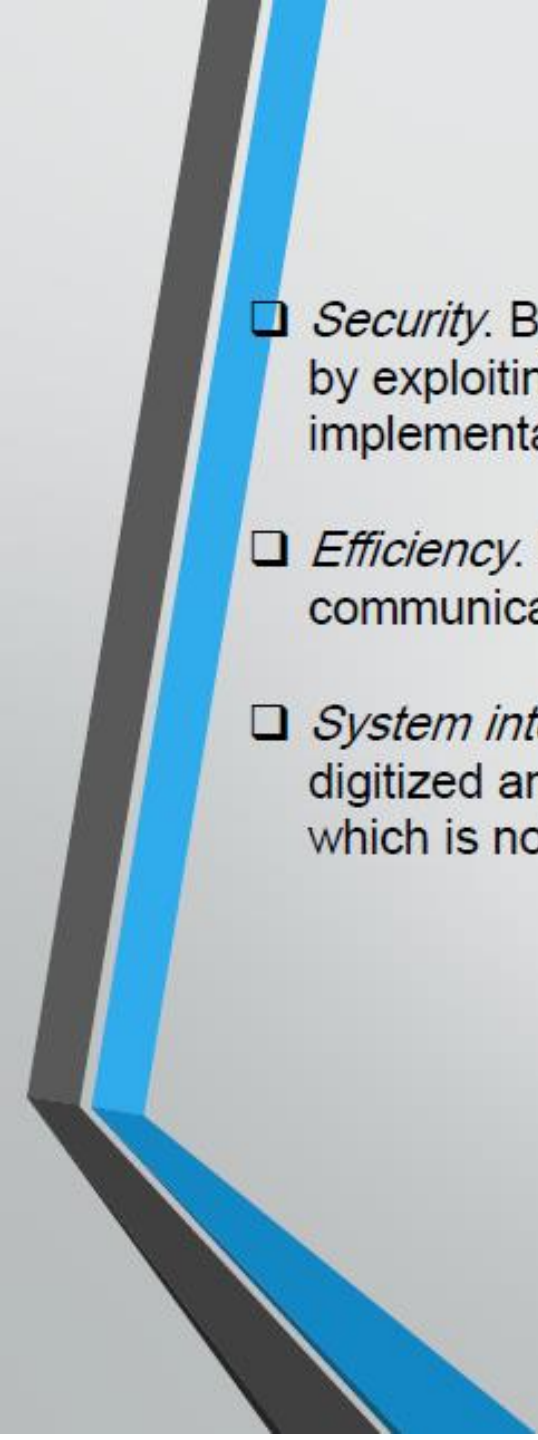

Pulse Modulation

Transition from Analog to Digital

Advantages:

- ❑ *Performance.* In an analog communication system, the effects of signal distortion and channel noise are *cumulative*. These sources of impairments therefore tend to become progressively stronger, ultimately overwhelming the ability of the communication system to offer an acceptable level of performance from source to destination. Unfortunately, the use of repeaters in the form of amplifiers, placed at different points along the transmission path, offers little help because the message signal and noise are amplified to the same extent. In sharp contrast, digital pulse modulation permits the use of *regenerative repeaters*, which, when placed along the transmission path at short enough distances, can practically eliminate the degrading effects of channel noise and signal distortion.
- ❑ *Ruggedness.* Unlike an analog communication system, a digital communication system can be designed to withstand the effects of channel noise and signal distortion, provided the noise and distortion are kept under certain limits.

- 
- ❑ *Security.* By the same token, digital communication systems can be made highly secure by exploiting powerful encryption algorithms that rely on digital processing for their implementation.
 - ❑ *Efficiency.* Digital communication systems are inherently more efficient than analog communication systems in the tradeoff between transmission bandwidth and signal to-noise ratio.
 - ❑ *System integration.* The use of digital communications makes it possible to integrate digitized analog signals (i.e., voice and video signals) with digital computer data, which is not possible with analog communications.

Sampling Process

- *Lesson 1: Given a strictly band-limited message signal, the sampling theorem embodies the conditions for a uniformly sampled version of the signal to preserve its information content.*

Lesson 2: Analog pulse-modulation systems rely on the sampling process to maintain continuous amplitude representation of the message signal. In contrast, digital pulse-modulation systems use not only the sampling process but also the quantization process, which is non-reversible. Quantization provides a representation of the message signal that is discrete in both time and amplitude. In so doing, digital pulse modulation makes it possible to exploit the full power of digital signal-processing techniques.

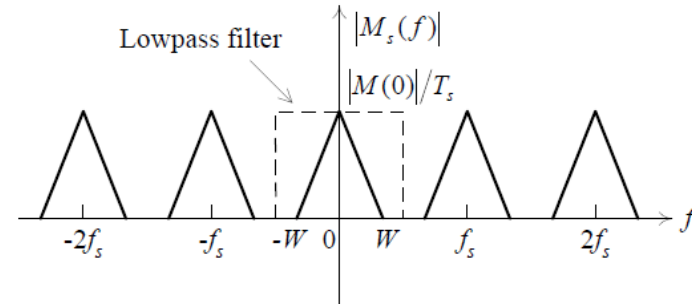
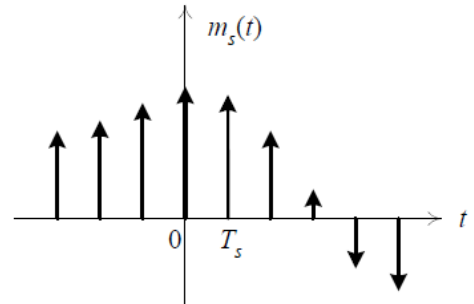
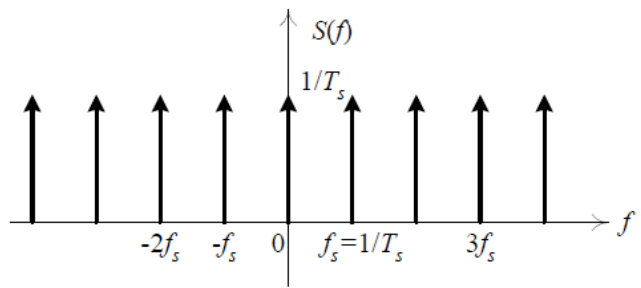
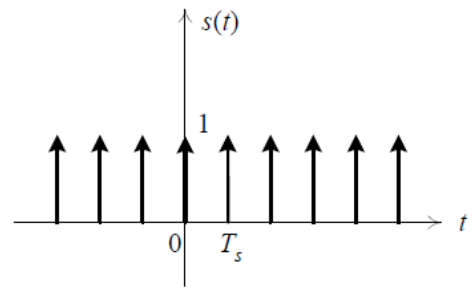
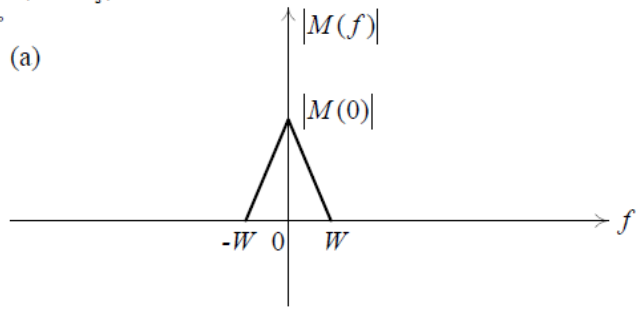
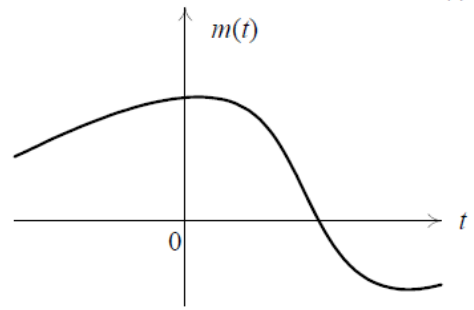
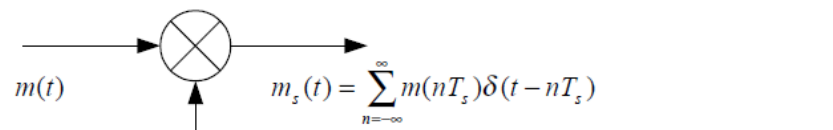

Thus the sampled waveform $m_s(t)$ can be expressed as,

$$\begin{aligned}m_s(t) = m(t)s(t) &= \sum_{n=-\infty}^{\infty} m(t)\delta(t - nT_s) \\ &= \sum_{n=-\infty}^{\infty} m(nT_s)\delta(t - nT_s)\end{aligned}$$

$$S(f) = \frac{1}{T_s} \sum_{n=-\infty}^{\infty} \delta(f - nf_s)$$

$$X(f) \otimes \delta(f - f_0) = X(f - f_0)$$

$$\begin{aligned}M_s(f) = M(f) \otimes S(f) &= M(f) \otimes \left[\frac{1}{T_s} \sum_{n=-\infty}^{\infty} \delta(f - nf_s) \right] \\ &= \frac{1}{T_s} \sum_{n=-\infty}^{\infty} M(f - nf_s)\end{aligned}$$

How to reconstruct signal $m(t)$ from sampled version $m(nT_s)$

$$\begin{aligned}M_s(f) = \mathcal{F}\{m_s(t)\} &= \sum_{n=-\infty}^{\infty} m(nT_s)\mathcal{F}\{\delta(t - nT_s)\} \\ &= \sum_{n=-\infty}^{\infty} m(nT_s)\exp(-j2\pi n f T_s)\end{aligned}$$

Since $M(f) = M_s(f)/f_s$, for $-W \leq f \leq W$, one can write

$$M(f) = \frac{1}{f_s} \sum_{n=-\infty}^{\infty} m(nT_s)\exp(-j2\pi n f T_s), \quad -W \leq f \leq W$$

$$\begin{aligned}
m(t) = \mathcal{F}^{-1}\{M(f)\} &= \int_{-\infty}^{\infty} M(f)\exp(j2\pi ft)df \\
&= \int_{-W}^W \frac{1}{f_s} \sum_{n=-\infty}^{\infty} m(nT_s)\exp(-j2\pi nfT_s)\exp(j2\pi ft)df \\
&= \frac{1}{f_s} \sum_{n=-\infty}^{\infty} m(nT_s) \int_{-W}^W \exp[j2\pi f(t - nT_s)]df \\
&= \sum_{n=-\infty}^{\infty} m(nT_s) \frac{\sin[2\pi W(t - nT_s)]}{\pi f_s(t - nT_s)} \\
&= \sum_{n=-\infty}^{\infty} m\left(\frac{n}{2W}\right) \frac{\sin(2\pi Wt - n\pi)}{(2\pi Wt - n\pi)} \\
&= \sum_{n=-\infty}^{\infty} m\left(\frac{n}{2W}\right) \text{sinc}(2Wt - n)
\end{aligned}$$

Interpolation Formula

Aliasing

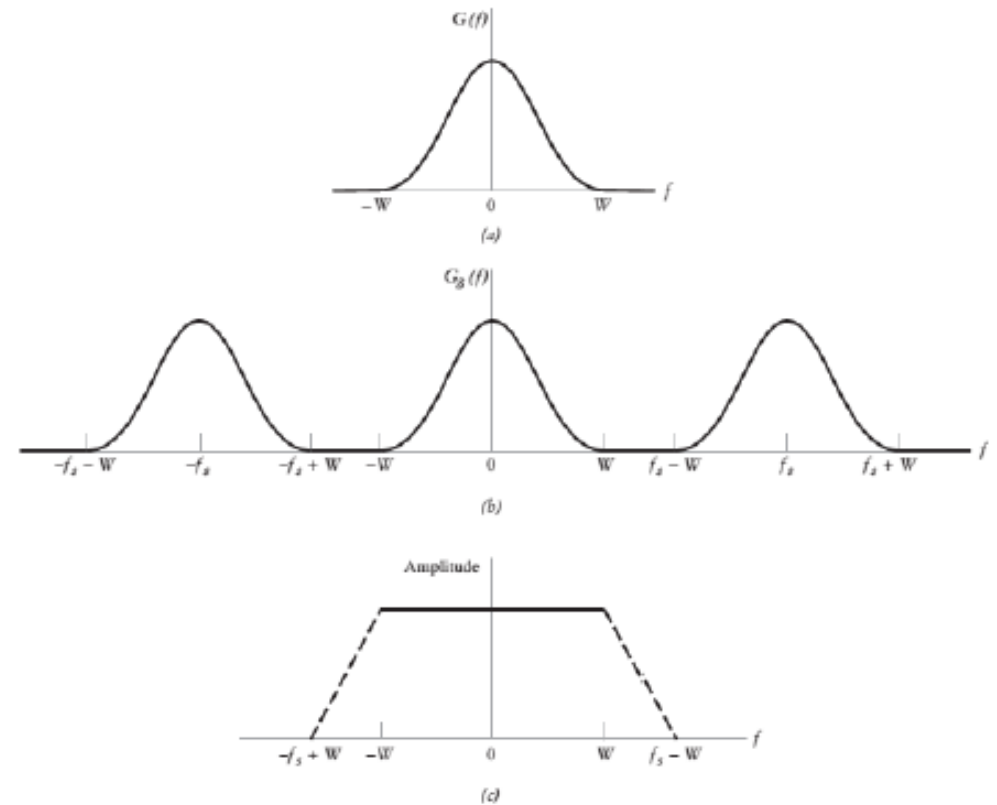
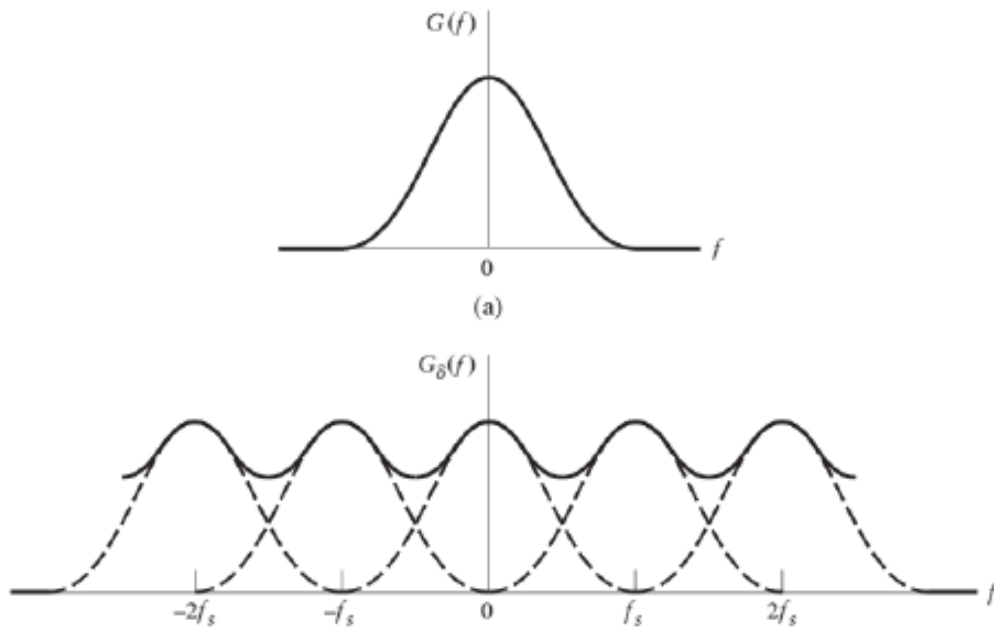

To combat the effects of aliasing in practice, we may use two *corrective measures*:

1. Prior to sampling, a low-pass *anti-alias filter* is used to attenuate those high-frequency components of a message signal that are not essential to the information being conveyed by the signal.
2. The filtered signal is sampled at a rate slightly higher than the Nyquist rate.

Pulse Amplitude Modulation (PAM)

pulse-amplitude modulation, which is the simplest and most basic form of analog pulse modulation techniques. In *pulse-amplitude modulation (PAM)*, the amplitudes of regularly spaced pulses are varied in proportion to the corresponding sample values of a continuous message signal. The pulses can be of a rectangular form or some other appropriate shape, where the message signal is multiplied by a periodic train of rectangular pulses.

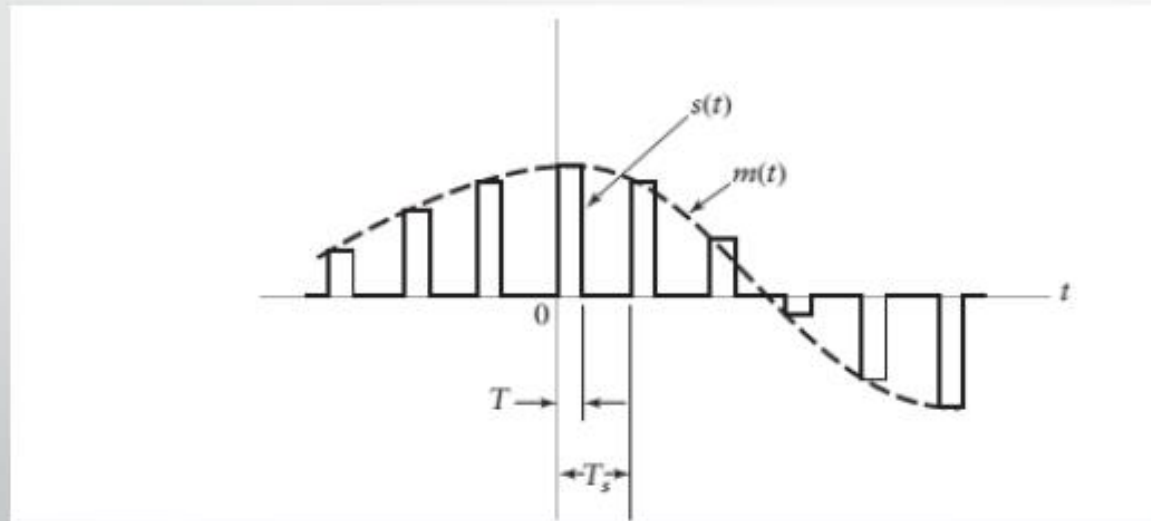

Sample and Hold

$$s(t) = \sum_{n=-\infty}^{\infty} m(nT_s)h(t - nT_s)$$

$$h(t) = \text{rect}\left(\frac{t - \frac{T}{2}}{T}\right) = \begin{cases} 1, & 0 < t < T \\ \frac{1}{2}, & t = 0, t = T \\ 0, & \text{otherwise} \end{cases}$$

$$m_{\delta}(t) = \sum_{n=-\infty}^{\infty} m(nT_s)\delta(t - nT_s)$$

$$\begin{aligned} m_{\delta}(t) \star h(t) &= \int_{-\infty}^{\infty} m_{\delta}(\tau)h(t - \tau) d\tau \\ &= \int_{-\infty}^{\infty} \sum_{n=-\infty}^{\infty} m(nT_s)\delta(\tau - nT_s)h(t - \tau) d\tau \\ &= \sum_{n=-\infty}^{\infty} m(nT_s) \int_{-\infty}^{\infty} \delta(\tau - nT_s)h(t - \tau) d\tau \end{aligned}$$

$$\int_{-\infty}^{\infty} \delta(\tau - nT_s)h(t - \tau) d\tau = h(t - nT_s)$$

$$m_{\delta}(t) \star h(t) = \sum_{n=-\infty}^{\infty} m(nT_s)h(t - nT_s)$$

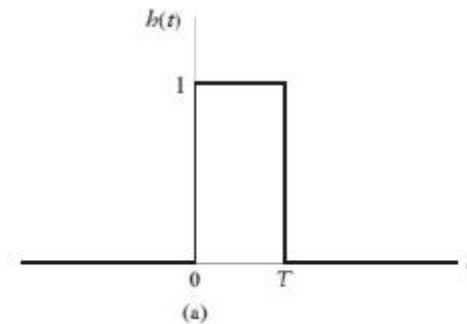

S/H Circuit

$$s(t) = m_{\delta}(t) \star h(t)$$

$$S(f) = M_{\delta}(f)H(f)$$

$$m_{\delta}(t) \star h(t) = \sum_{n=-\infty}^{\infty} m(nT_s)h(t - nT_s)$$

$$M_{\delta}(f) = f_s \sum_{k=-\infty}^{\infty} M(f - kf_s)$$

$$S(f) = f_s \sum_{k=-\infty}^{\infty} M(f - kf_s)H(f)$$

Aperture Effect

Amplitude distortion is resulted



Equalizer:

$$\frac{1}{|H(f)|} = \frac{1}{T \operatorname{sinc}(fT)} = \frac{\pi f}{\sin(\pi fT)}$$

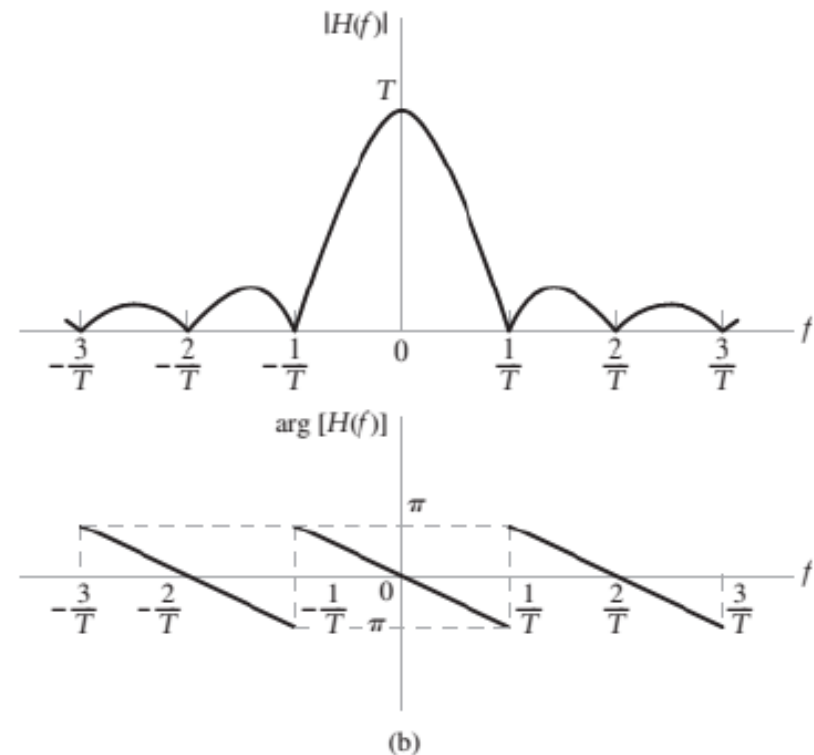
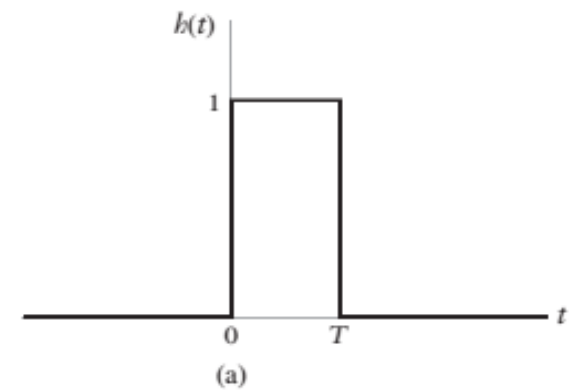

The amount of equalization needed in practice is usually small. Indeed, for a duty cycle $(T/T_s) \leq 0.1$, the amplitude distortion is less than 0.5 percent, in which case the need for equalization may be omitted altogether.

Pulse Position Modulation

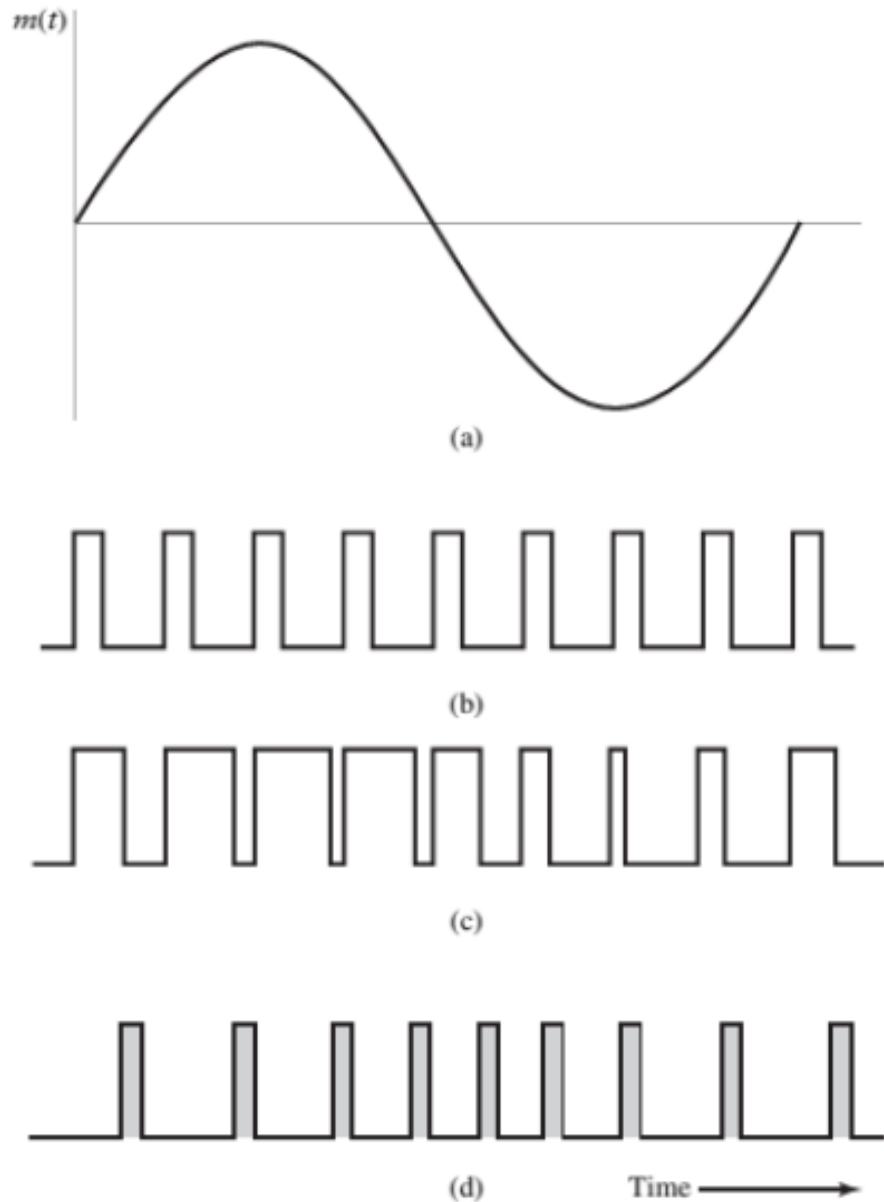

In pulse-amplitude modulation, pulse amplitude is the variable parameter. Pulse duration is the next logical parameter available for modulation. *In pulse-duration modulation (PDM), the samples of the message signal are used to vary the duration of the individual pulses.* This form of modulation is also referred to as *pulse-width modulation* or *pulse-length modulation*. The modulating signal may vary the time of occurrence of the leading edge, the trailing edge, or both edges of the pulse.

PDM is wasteful of power, If this unused power is subtracted from PDM, so that only time transitions are essentially preserved, we obtain a more efficient type of pulse modulation known as *pulse-position modulation (PPM)*. In *PPM*, the position of a pulse relative to its unmodulated time of occurrence is varied in accordance with the message signal,

Illustration of PAM, PWM and PPM

(a) is input (information) signal

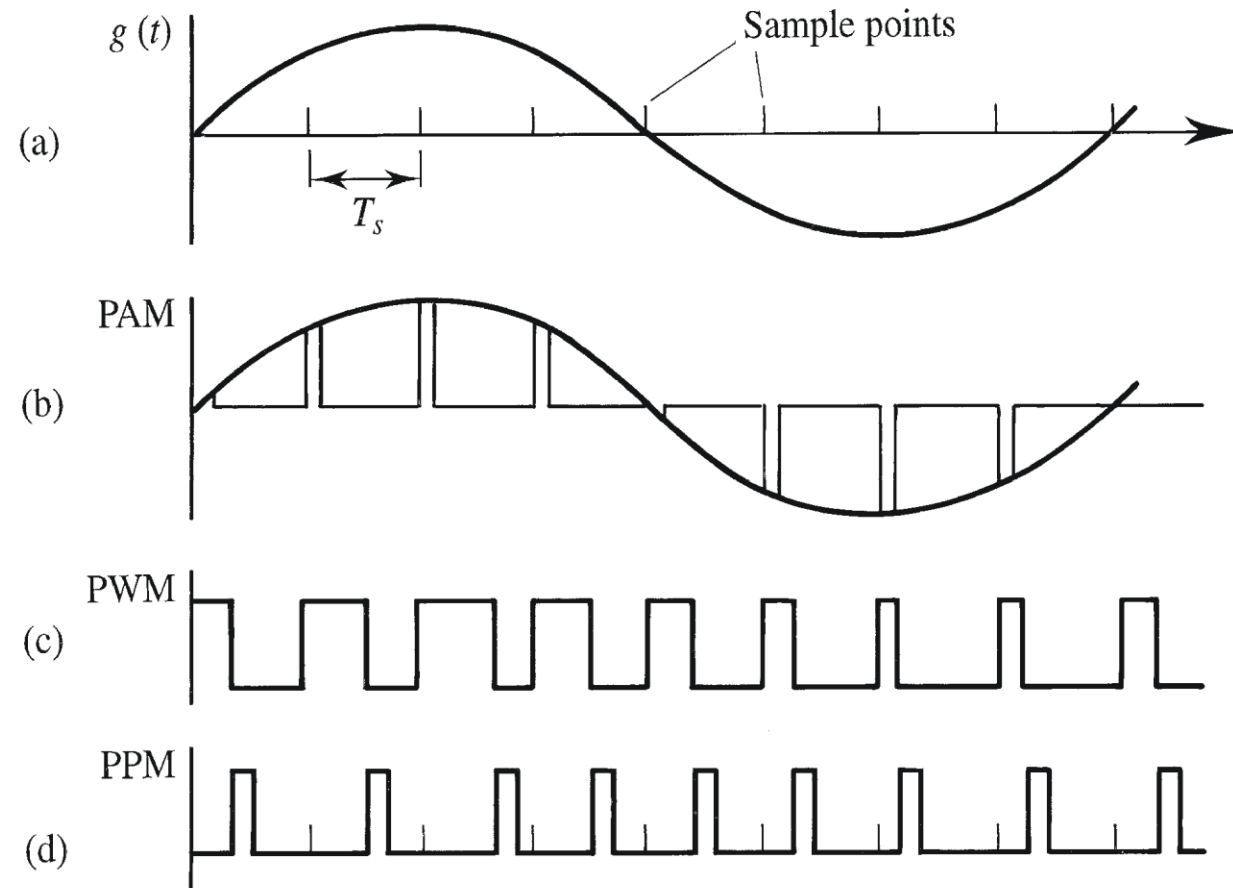

Use in Ethernet

- Some versions of the [Ethernet](#) communication standard are an example of PAM usage.
- In particular, the [Fast Ethernet](#) 100BASE-T2 medium (now defunct), running at 100 Mbit/s, uses five-level PAM modulation (PAM-5) running at 25 megapulses/sec over two wire pairs.
- Later, the [gigabit Ethernet](#) 1000BASE-T medium raised the bar to use four pairs of wire running each at 125 megapulses/sec to achieve 1000 Mbit/s data rates, still utilizing PAM-5 for each pair.

Pulse Width Modulation

- **Pulse-width modulation (PWM)**, or **pulse-duration modulation (PDM)**, is a commonly used technique for controlling power to inertial electrical devices, made practical by modern electronic power switches.
- The PWM switching frequency has to be much faster than what would affect the load, which is to say the device that uses the power.
- The main advantage of PWM is that power loss in the switching devices is very low.
- PWM has also been used in certain [communication systems](#) where its duty cycle has been used to convey information over a communications channel.

Principle

- Pulse-width modulation uses a [rectangular pulse wave](#) whose pulse width is modulated resulting in the variation of the [average](#) value of the waveform.
- The simplest way to generate a PWM signal is the intersective method, which requires only a [sawtooth](#) or a [triangle](#) waveform (easily generated using a simple [oscillator](#)) and a [comparator](#)
- When the value of the reference signal (the red sine wave) is more than the modulation waveform (blue), the PWM signal (magenta) is in the high state, otherwise it is in the low state.

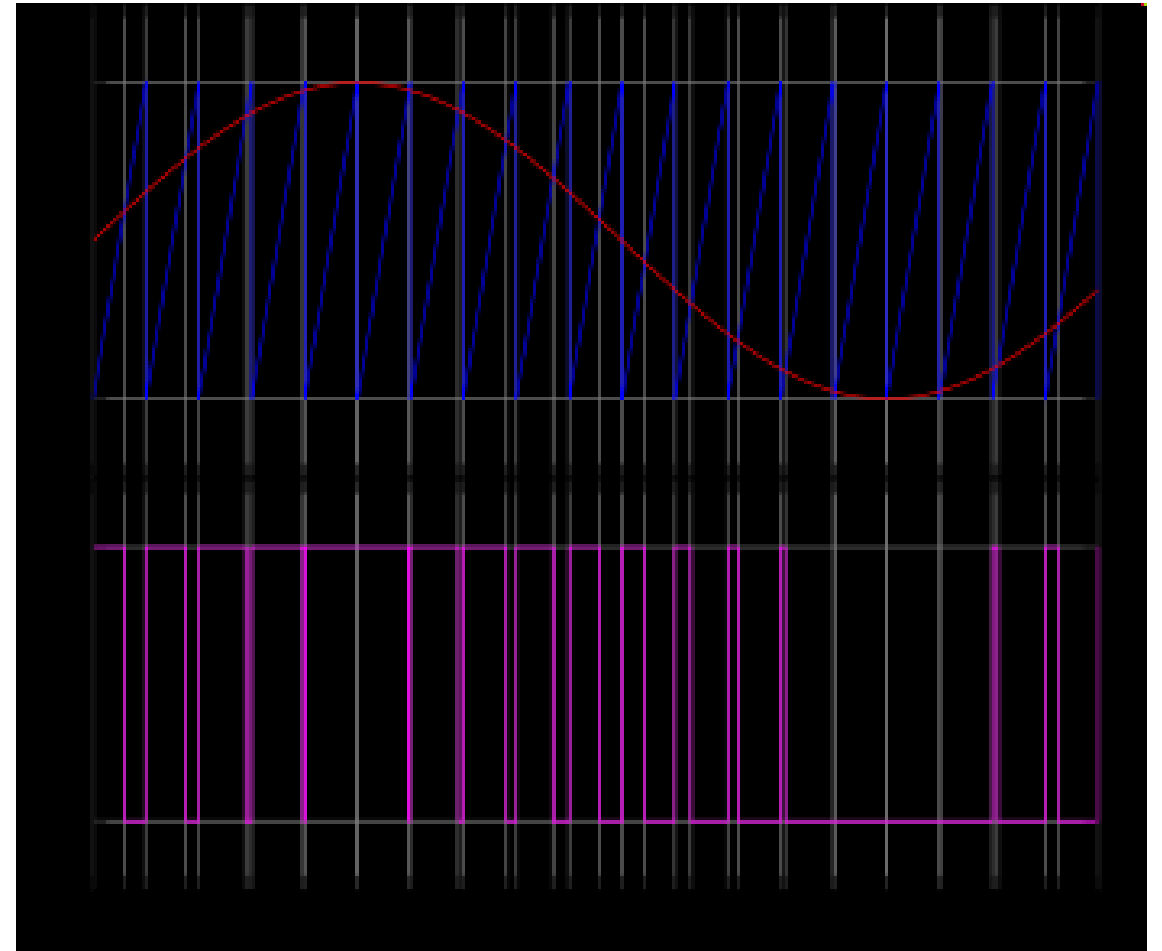

Pulse Position Modulation

- **Pulse-position modulation** (PPM) is a form of signal [modulation](#) in which M message bits are encoded by transmitting a single pulse in one of M possible time-shifts
- One of the key difficulties of implementing this technique is that the receiver must be properly synchronized to align the local clock with the beginning of each symbol. Therefore, it is often implemented differentially as *differential pulse-position modulation*, whereby each pulse position is encoded relative to the previous, such that the receiver must only measure the difference in the [arrival time](#) of successive pulses.
- It is possible to limit the propagation of errors to adjacent symbols, so that an error in measuring the differential delay of one pulse will affect only two symbols, instead of affecting all successive measurements.

Quantization Process

Continuous
sample m

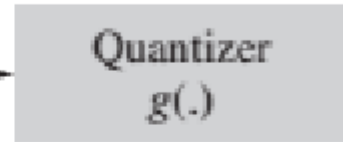

Discrete
sample ν

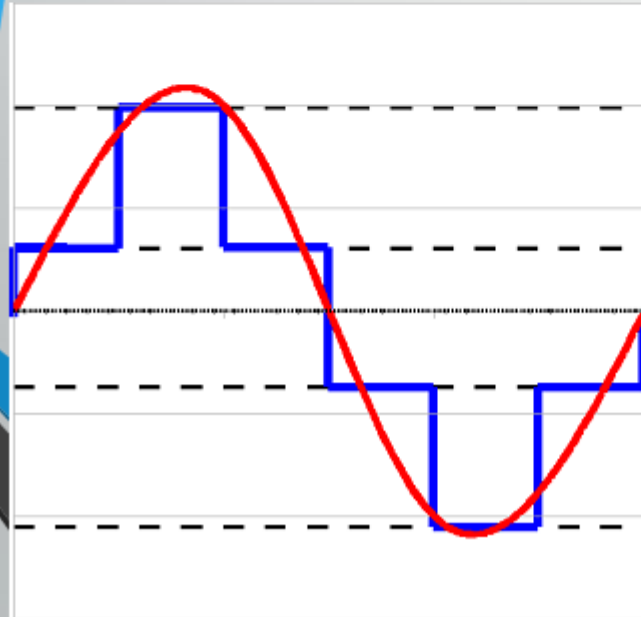
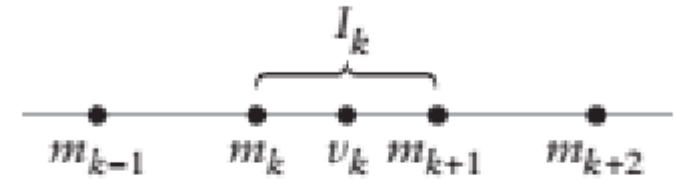

11
10
01
00

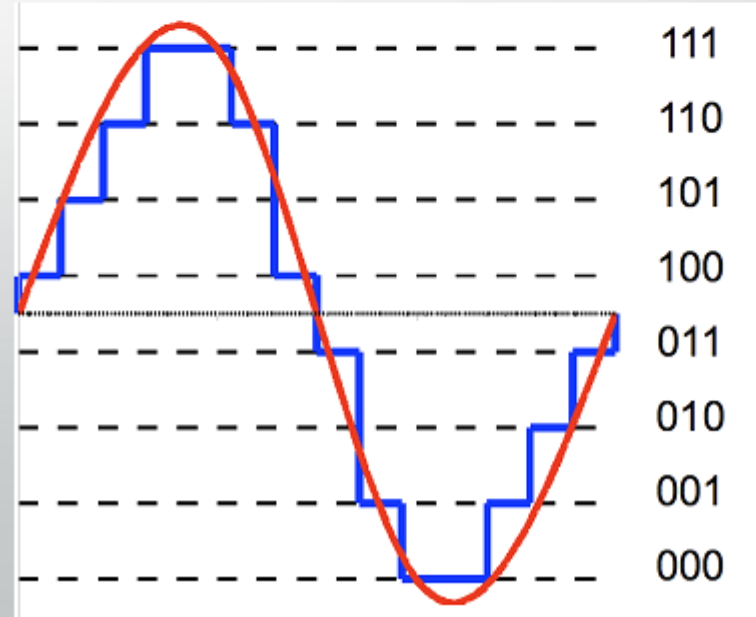

Midtread Quantizer

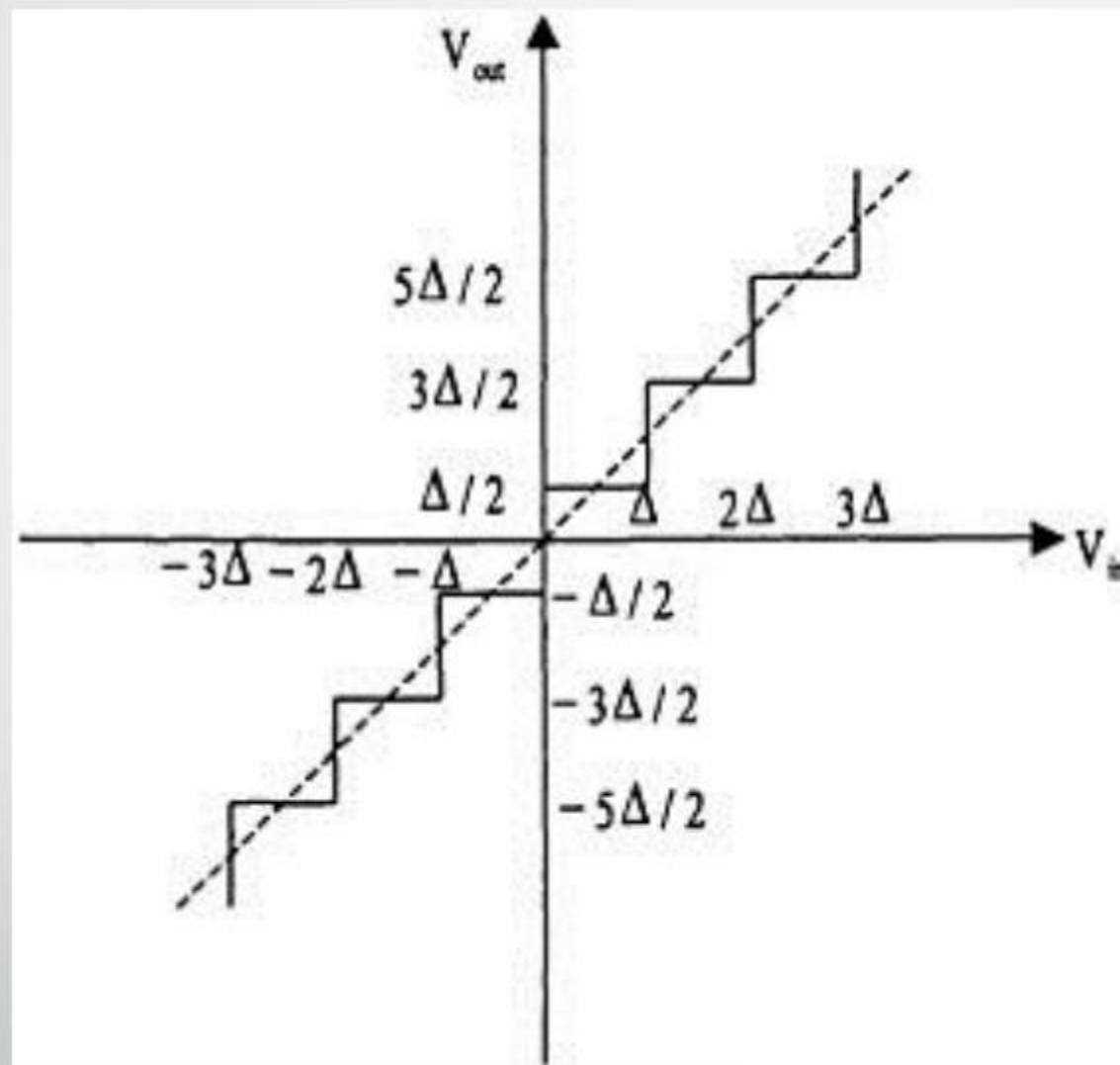

$$Q = 2^n$$

$$\text{If } (m-1)\Delta < V_{in} < m\Delta \implies V_{out} = (m - \frac{1}{2})\Delta$$

$$m = -\frac{Q}{2} + 1, -\frac{Q}{2} + 2, \dots, \frac{Q}{2} - 1,$$

Midrise Quantizer

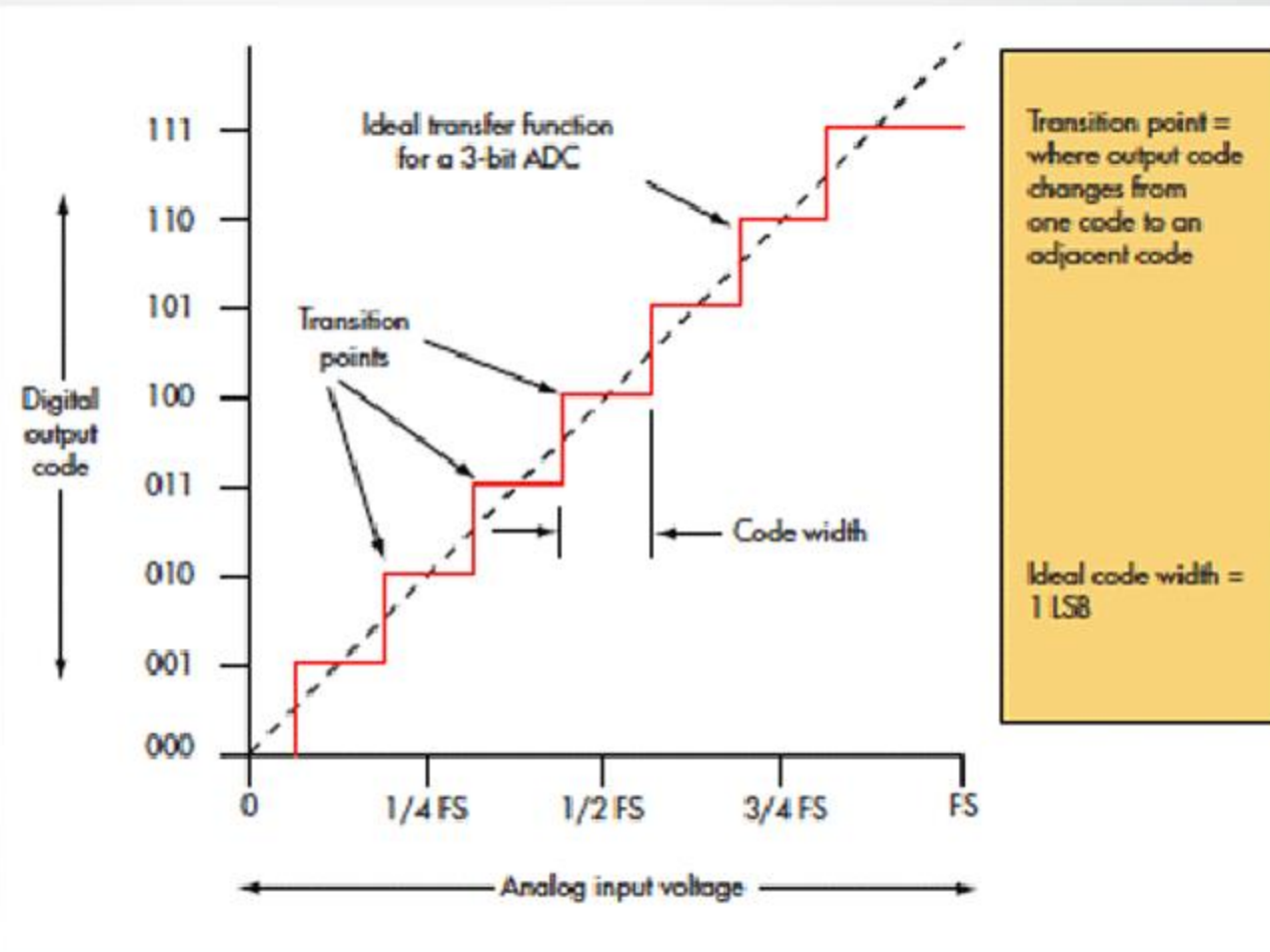
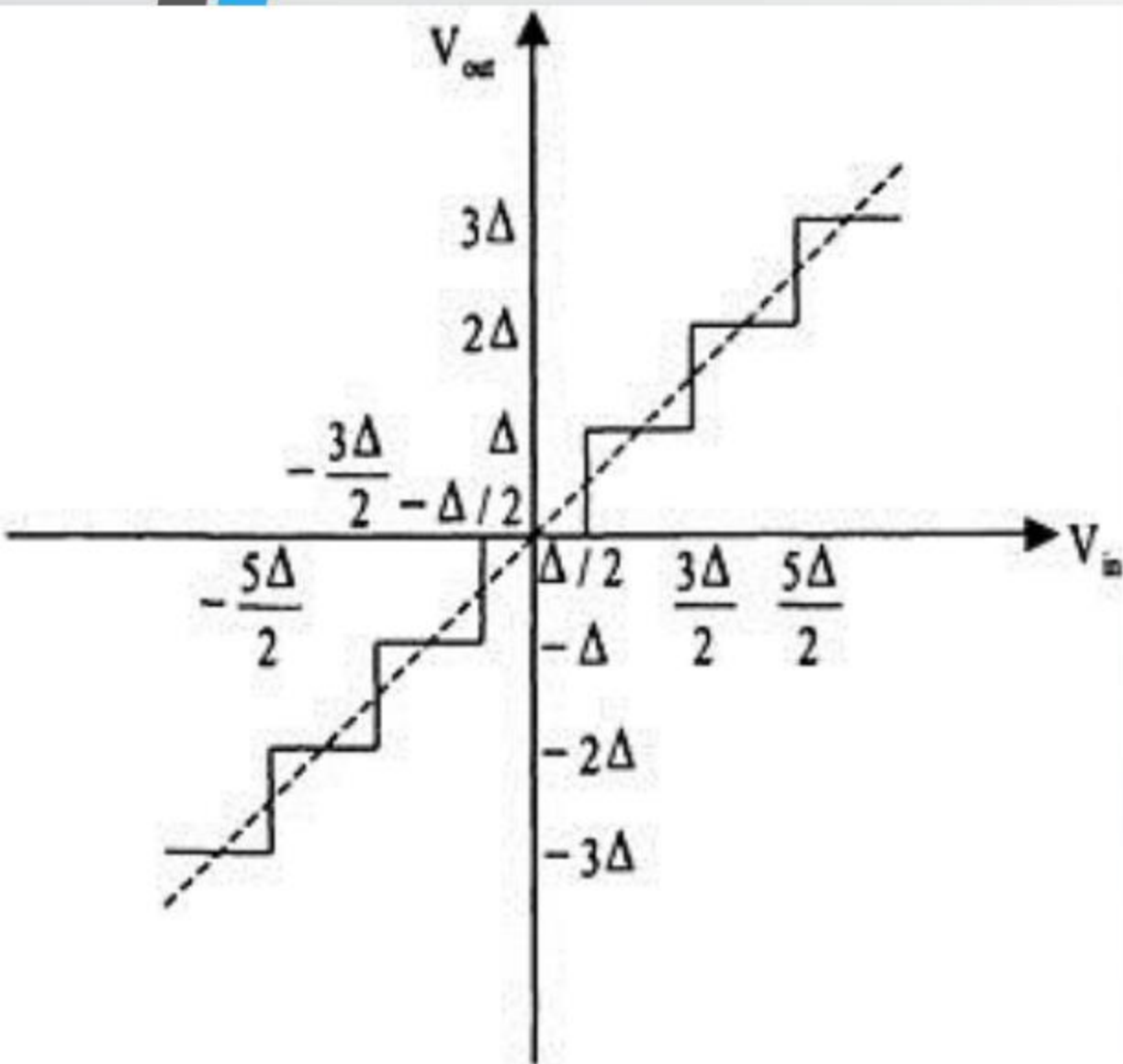

Quantization Signal to Noise Ratio – QSNR-

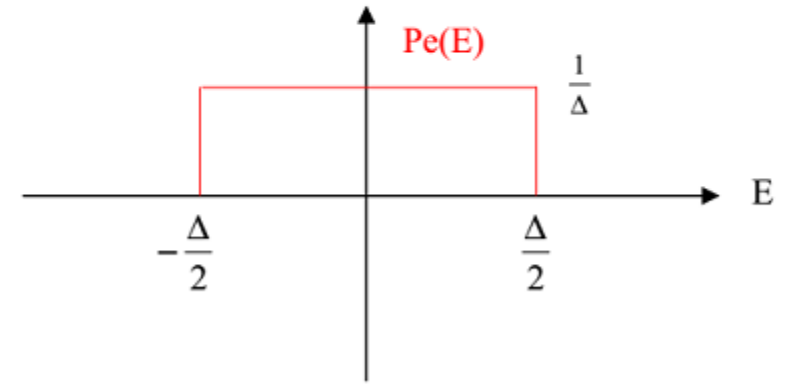
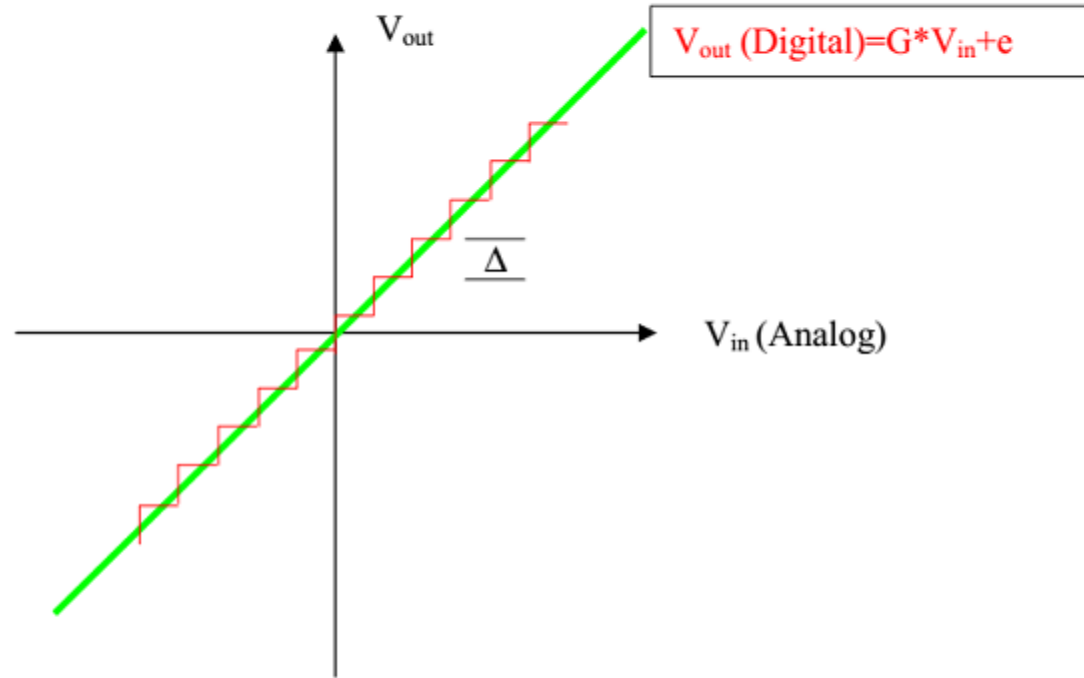

PDF of Quantization Error

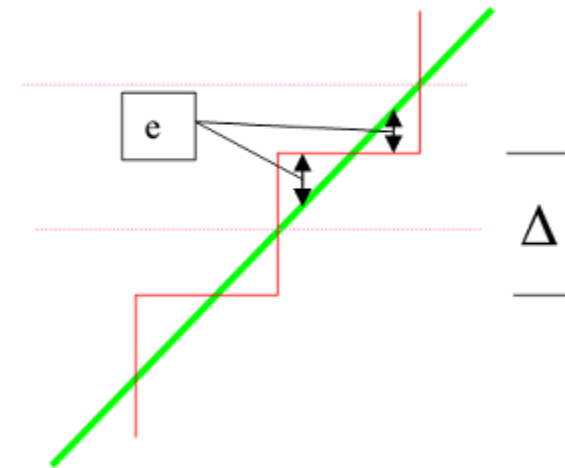

Zoom in of Staircase

Uniform versus Non-uniform Quantizer

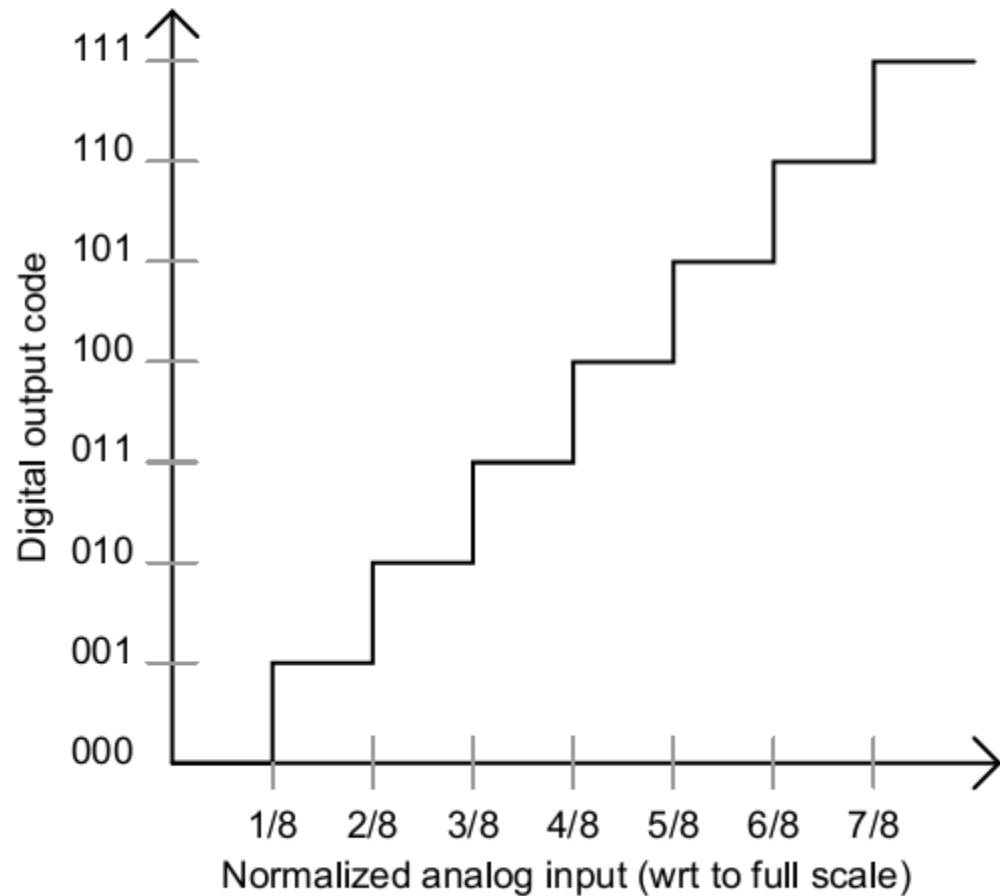

Fig : Uniform Quantization

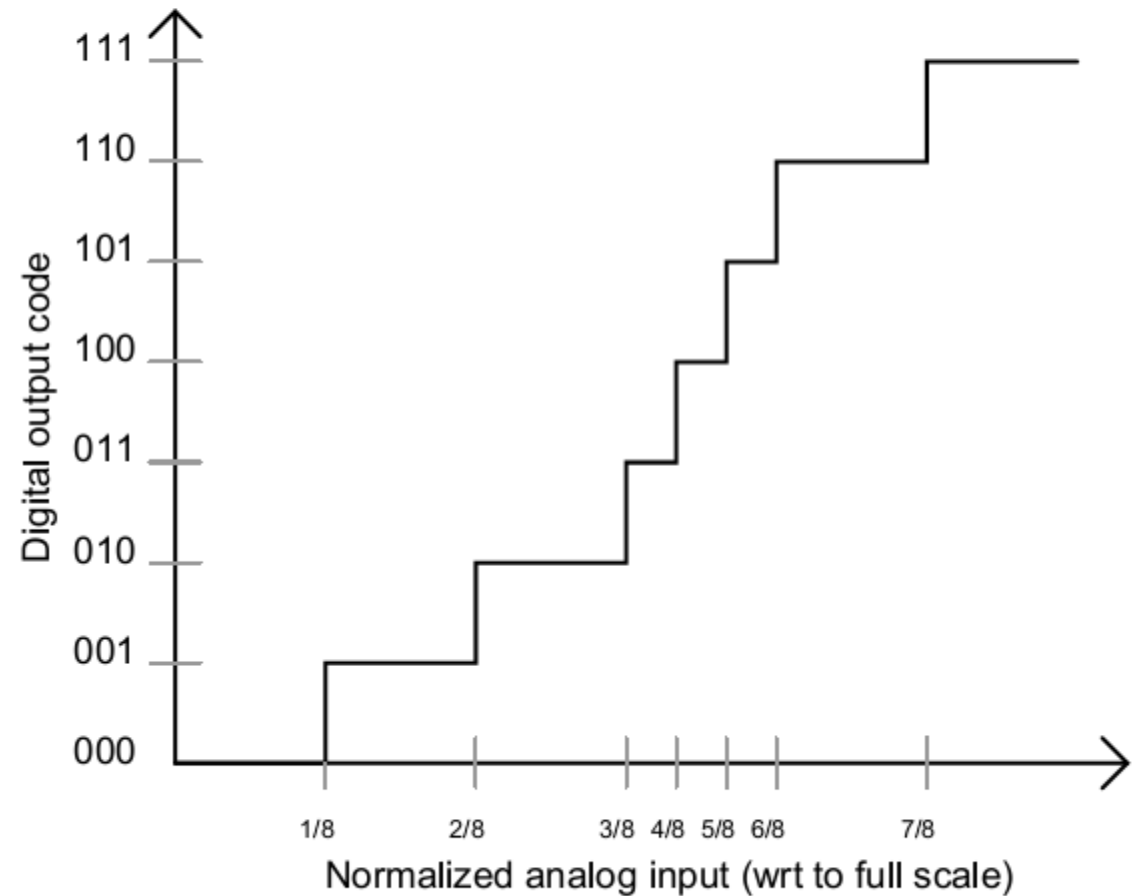

Fig : Non-uniform Quantization

- $\sigma_{QNoise}^2 = E(e^2) = \int_{-\frac{\Delta}{2}}^{\frac{\Delta}{2}} \frac{1}{\Delta} e^2 de = \frac{1}{\Delta} \frac{e^3}{3} \Big|_{-\frac{\Delta}{2}}^{\frac{\Delta}{2}} = \frac{1}{\Delta} \left[\frac{\left(\frac{\Delta}{2}\right)^3}{3} - \frac{\left(-\frac{\Delta}{2}\right)^3}{3} \right] = \frac{1}{\Delta} \left[\frac{\Delta^3}{24} - \frac{-\Delta^3}{24} \right] = \frac{\Delta^2}{12}$

- $\sigma_{QNoise}^2 = \text{Quantization Noise Power} = \frac{\Delta^2}{12}$

- $\sigma_{QNoise} = V_{QNoise_rms} = \frac{\Delta}{\sqrt{12}}$

- RMS value for a full scale sinusoidal input is

$$V_{MaxSignal_rms} = \frac{\left(\frac{2^N}{2}\right)}{\sqrt{2}} \Delta$$

- $$\text{Max SNR} = 20 \log \left(\frac{\left(\frac{2^N}{2}\right) \frac{\Delta}{\sqrt{2}}}{\frac{\Delta}{\sqrt{12}}} \right) = 20 \log \left(\frac{\sqrt{6}}{2} 2^N \right) = 20 \log \left(\frac{\sqrt{6}}{2} \right) + 20N \log(2)$$

$$= 1.76 + 6.02N$$

- $$N = \text{Effective\# of Bits} = \frac{\text{Max SNR} - 1.76}{6.02}$$

Exercise: Consider Vin = 1/8 of the full scale. Determine QSNR

$$\text{QSNR} = -10.28 + 6.02n$$

Less 12 dB since input power is reduced by 12 dB.

Note: Range of input signal does not match the dynamic range of the quantizer

Pulse Code Modulation-PCM-

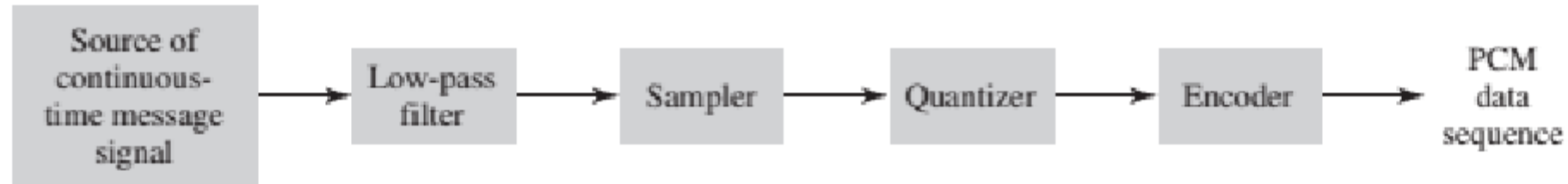

(a)



(b)



(c)

Pulse Code Modulation

Pulse Code Modulation is the most commonly used technique in the PAM family and uses a sampling rate of 8000 samples per second.

Each sample is an 8 bit sample resulting in a digital rate of 64,000 bps (8×8000).

Sampling Theorem: If a signal is sampled at a rate higher than twice the highest signal frequency, then the samples contain all the information of the original signal.

E.g.: For voice capped at 4Khz, can sample at 8000 times per second to regenerate the original signal.

Bit rate and bandwidth requirements of PCM

- The bit rate of a PCM signal can be calculated from the number of bits per sample \times the sampling rate

$$\text{Bit rate} = n_b \times f_s$$

- The bandwidth required to transmit this signal depends on the type of line encoding used. Generally, BW is $\text{BW} = (\text{bit rate})/2$
- A digitized signal will always need more bandwidth than the original analog signal. Price we pay for robustness and other features of digital transmission.

Nonuniform Quantizer

Pulse code modulation (PCM) is a common method of digitizing or quantizing an analog waveform. For any analog-to-digital conversion process, the quantization step produces an estimate of the waveform sample using a digital codeword. This digital estimate inherently contains some level of error due to the finite number of bits available. In practical terms, there is always tradeoff **between the amount of error and the size of the digital data samples**.

The goal in any system design is **quantizing the data in smallest number of bits** that results in a tolerable level of error. In the case of speech coding, linear quantization with 13 bits sampled at 8 KHz is the minimum required to accurately produce a digital representation of the full range of speech signals. For many transmission systems, wired or wireless, 13 bits sampled at 8 KHz is an **expensive proposition as far as bandwidth is concerned**. To address this constraint, a companding system is often employed. Companding is simply a system in which information is first compressed, transmitted through a bandwidthlimited channel, and expanded at the receiving end. It is frequently used to reduce the bandwidth requirements for transmitting telephone quality speech, by reducing the 13-bit codewords to 8-bit codewords. Two international standards for encoding signal data to 8-bit codes are A-law and m-law. A-law is the accepted European standard, while m-law is the accepted standard in the United States and Japan.

Non-uniform Quantizer

- ❑ For a fixed uniform quantizer, an input signal with an amplitude less than the full dynamic load of the quantizer will have lower SQNR than a signal whose amplitude occupies the full range of the equalizer
- ❑ For speech signal, low amplitudes are more probable than larger amplitude
- ❑ For speech signals, a type nonuniform quantization was developed called logarithmic companding
- ❑ Low amplitude given more levels than higher amplitude because it is more probability of occurrence
- ❑ There are more quantization regions at lower amplitudes and less quantization regions at higher amplitudes

Non uniform Quantization

The use of a nonuniform quantizer is equivalent to passing the message signal through a *compressor* and then applying the compressed signal to a uniform quantizer. A particular form of compression law that is used in practice is the so called μ law defined by:

$$|v| = \frac{\log(1 + \mu|m|)}{\log(1 + \mu)}$$

where the logarithm is the natural logarithm; m and v are respectively the normalized input and output voltages

$$|v| = \begin{cases} \frac{A|m|}{1 + \log A}, & 0 \leq |m| \leq \frac{1}{A} \\ \frac{1 + \log(A|m|)}{1 + \log A}, & \frac{1}{A} \leq |m| \leq 1 \end{cases}$$

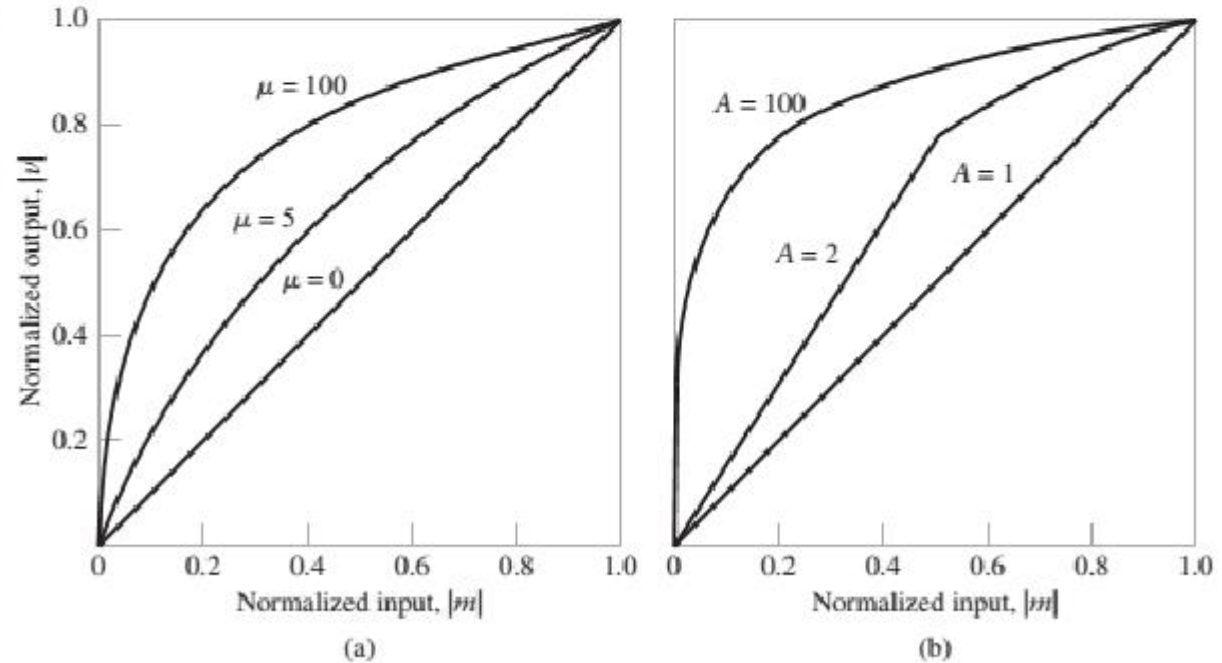
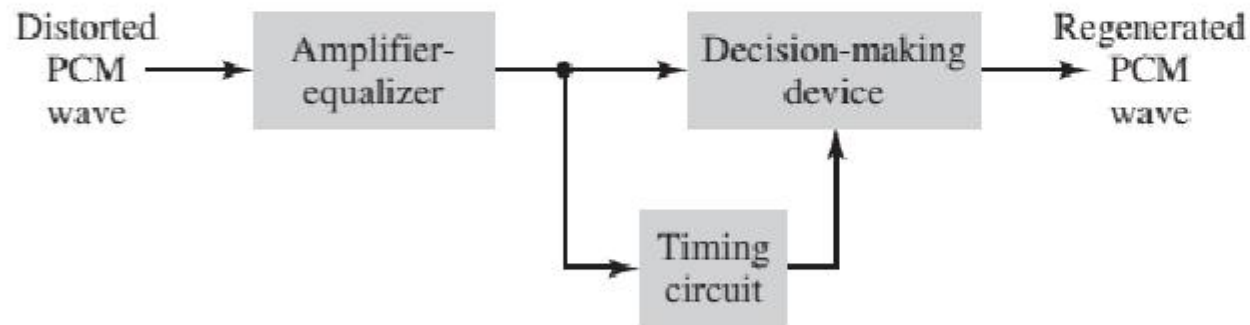

FIGURE 5.12 Compression laws. (a) μ -law. (b) A -law.

REGENERATION ALONG THE TRANSMISSION PATH

The most important feature of a PCM system lies in the ability to *control* the effects of distortion and noise produced by transmitting a PCM signal over a channel. This capability is accomplished by reconstructing the PCM signal by means of a chain of *regenerative repeaters* located at sufficiently close spacing along the transmission route.



equalization, timing, and decision making.

- The equalizer shapes the received pulses so as to compensate for the effects of amplitude and phase distortions produced by the transmission characteristics of the channel.

The timing circuitry provides a periodic pulse train, derived from the received pulses; this is done for renewed sampling of the equalized pulses at the instants of time where the signal-to-noise ratio is a maximum.

The sample so extracted is compared to a predetermined *threshold* in the decision-making device. In each bit interval, a decision is then made on whether the received symbol is a 1 or 0 on the basis of whether the threshold is exceeded or not

Operations in the Receiver

Decoding and Expanding

The first operation in the receiver is to *regenerate* (i.e., reshape and clean up) the received pulses one last time. These clean pulses are then regrouped into code words and decoded (i.e., mapped back) into a quantized PAM signal. The *decoding* process involves generating a pulse whose amplitude is the linear sum of all the pulses in the code word; each pulse is weighted by its place value in the code, where R is the number of bits per sample.

The sequence of decoded samples represents an *estimate* of the sequence of compressed samples produced by the quantizer in the transmitter. We use the term “estimate” here to emphasize the fact that there is no way for the receiver to compensate for the approximation introduced into the transmitted signal by the quantizer.

(ii) Reconstruction

The final operation in the receiver is to recover the message signal. This operation is achieved by passing the expander output through a *low-pass reconstruction filter* whose cutoff frequency is equal to the message bandwidth. Recovery of the message signal is intended to signify estimation rather than exact reconstruction.

Multiplexing

- ❑ To make efficient use of high-speed telecommunications lines, some form of multiplexing is used
- ❑ Multiplexing allows several transmission sources to share the same transmission media
- ❑ Trunks on long-haul networks are high-capacity fiber, coaxial, or microwave links
- ❑ Common forms of multiplexing are Frequency Division Multiplexing (FDM), Time Division Multiplexing (TDM), and Statistical TDM (STDM).

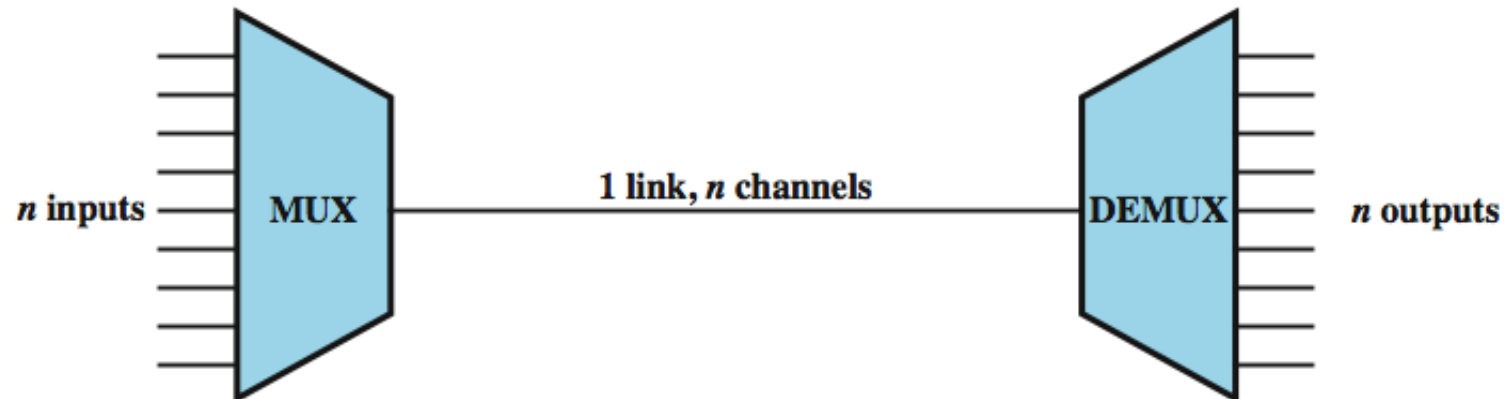

Multiplexing Techniques

❑ Frequency Division Multiplexing (FDM)

- Each signal is allocated a different frequency band
- Usually used with analog signals
- Modulation equipment is needed to move each signal to the required frequency band (channel)
- Multiple carriers are used, each is called sub-carrier
- Multiplexing equipment is needed to combine the modulated signals

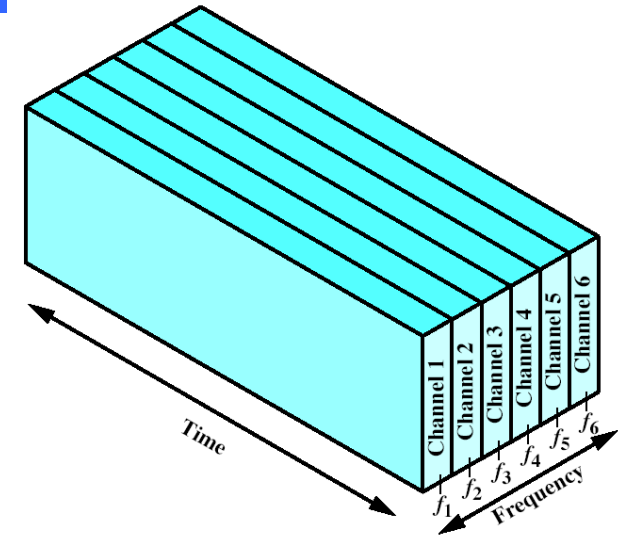

(a) Frequency division multiplexing

❑ Time Division Multiplexing (TDM)

- Usually used with digital signals or analog signals carrying digital data
- Data from various sources are carried in repetitive frames
- Each frame consists of a set of time slots
- Each source is assigned one or more time slots per frame

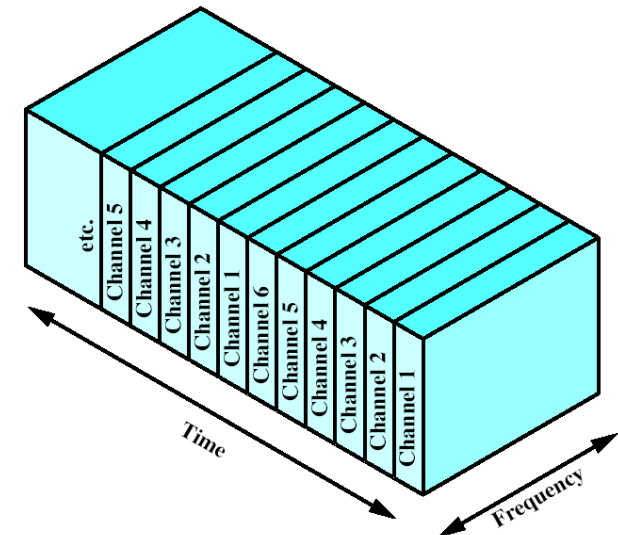

(b) Time division multiplexing

Example of FDM: Broadcast and Cable TV

- ❑ Figure (a) shows the time domain description of the AM modulated TV signal
- ❑ Figure (b) shows the frequency domain description of the TV signal
- ❑ The bandwidth of the TV signal is 6MHz
- ❑ Multiple TV signals can be FDM on a CATV coaxial cable
- ❑ Given that the bandwidth of the coaxial cable is up to 500MHz
- ❑ The number of TV signals or channels that can be multiplexed is up to $500/6=83$ TV signal or channel

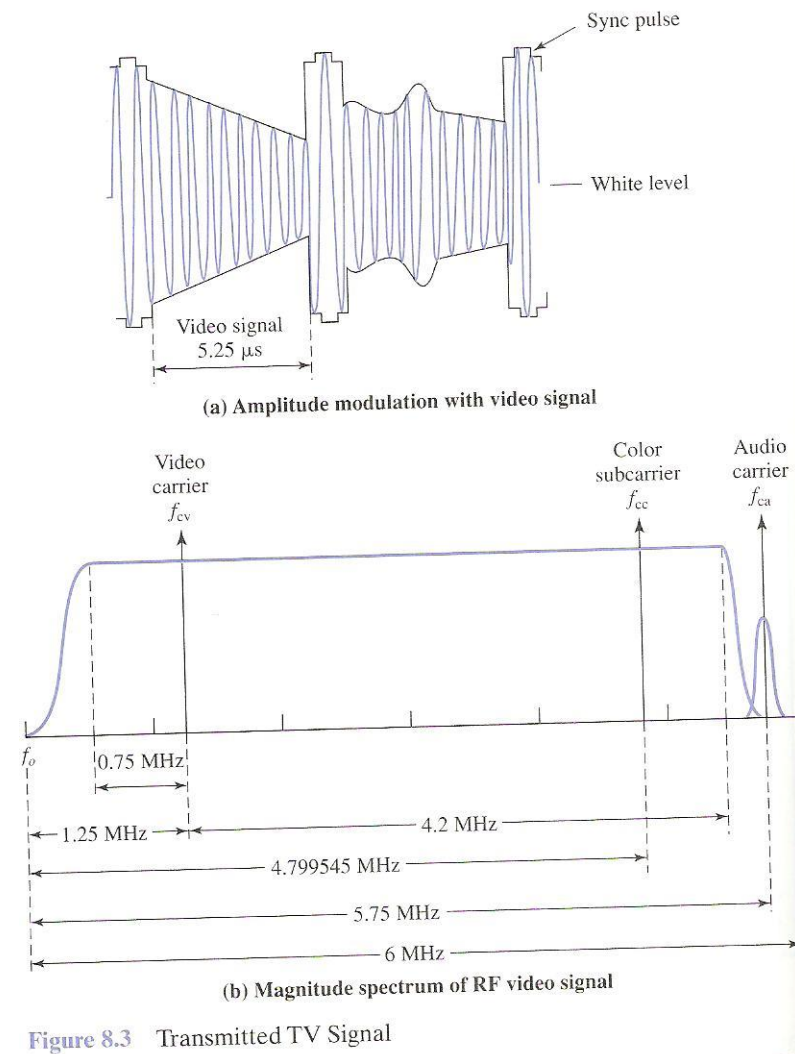

FDM example: multiplexing of three voice signals

- ❑ The bandwidth of a voice signal is generally taken to be 4KHz, with an effective spectrum of 300-3400Hz
- ❑ Such a signal is used to AM modulate 64 KHz carrier
- ❑ The bandwidth of the modulated signal is 8KHz and consists of the Lower Side Band (LSB) and USB as in (b)
- ❑ To make efficient use of bandwidth, transmit only the LSB
- ❑ If three voice signals are used to modulate carriers at 64, 68 and 72 KHz, and only the LSB is taken, the resulting spectrum will be as shown in (c)

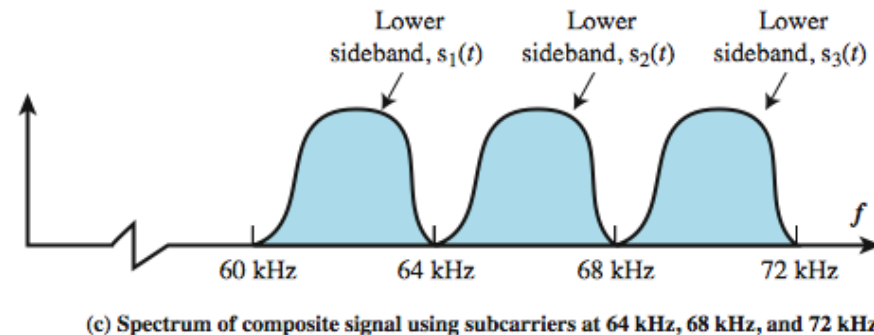
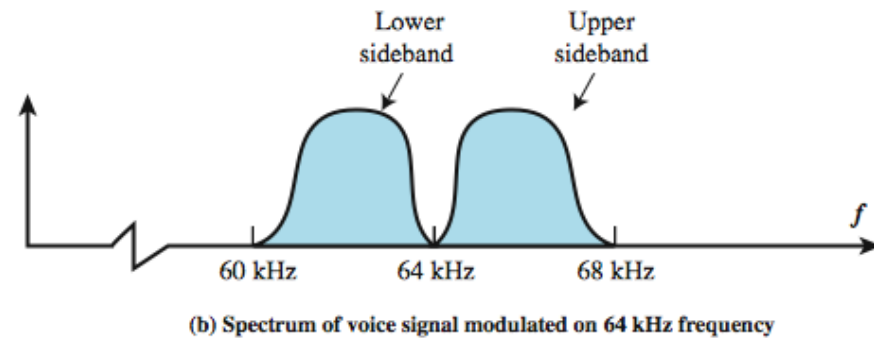
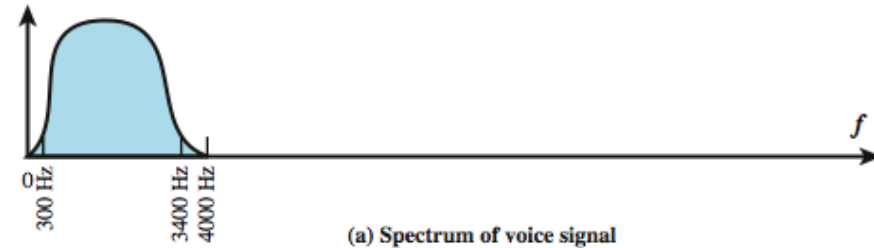

Analog Carrier Systems

- ❑ Long-distance links use an FDM hierarchy
- ❑ AT&T (USA) and ITU-T (International) variants
- ❑ Group
 - 12 voice channels (4kHz each) = 48kHz
 - in range 60kHz to 108kHz
- ❑ Supergroup
 - FDM of 5 group signals supports 60 channels
 - on carriers between 420kHz and 612 kHz
- ❑ Mastergroup
 - FDM of 10 supergroups supports 600 channels
- ❑ So original signal can be modulated many times

Wavelength Division Multiplexing (WDM)

- ❑ WDM: multiple beams of light at different frequencies or wavelengths are transmitted on the same fiber optic cable
- ❑ This is a form of Frequency Division Multiplexing (FDM)
- ❑ Commercial systems with 160 channels (frequencies, wavelengths or beams) of 10 Gbps each;
 $160 \times 10 \text{ Gbps} = 1.6 \text{ Tbps}$
- ❑ Alcatel laboratory demo of 256 channels of 39.8 Gbps each;
 $39.8 \times 256 = 10.1 \text{ Tbps}$
- ❑ architecture similar to other FDM systems
 - multiplexer multiplexes laser sources for transmission over single fiber
 - Optical amplifiers amplify all wavelengths
 - Demux separates channels at the destination
- ❑ Most WDM systems operates in the 1550 nm range
- ❑ Also have Dense Wavelength Division Multiplexing (DWDM) where channel spacing is less than 200GHz

Synchronous Time Division Multiplexing

- ❑ For example, a multiplexer has six inputs $n=6$ with 9.6 kbps. A single line with a capacity of at least 57.6 kbps could accommodate all six sources.

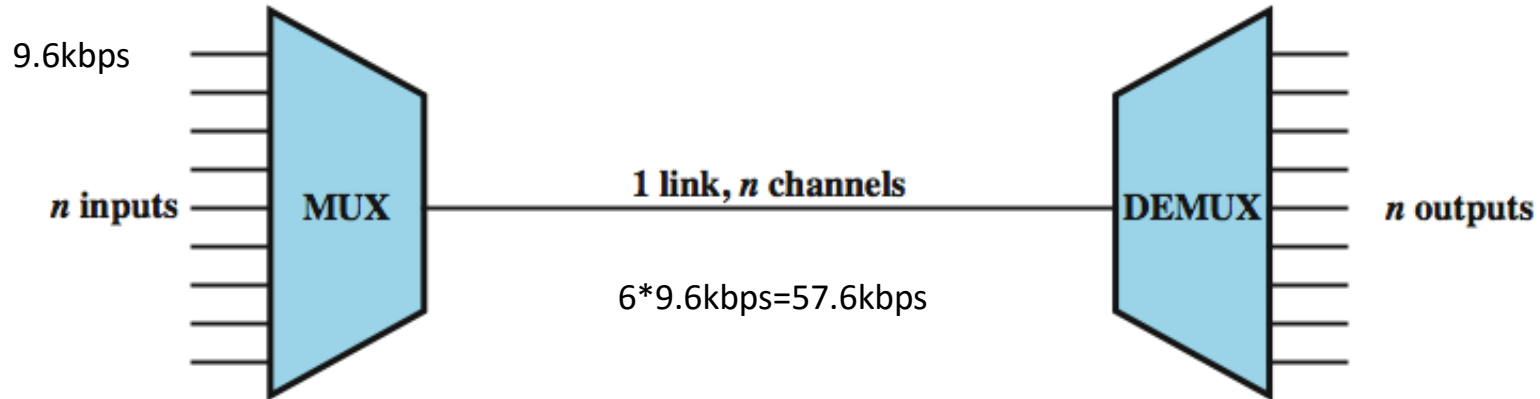

- ❑ Synchronous TDM is called synchronous as the time slots are pre-assigned to sources and fixed
- ❑ The time slots for each source are transmitted whether or not the source has data to send.

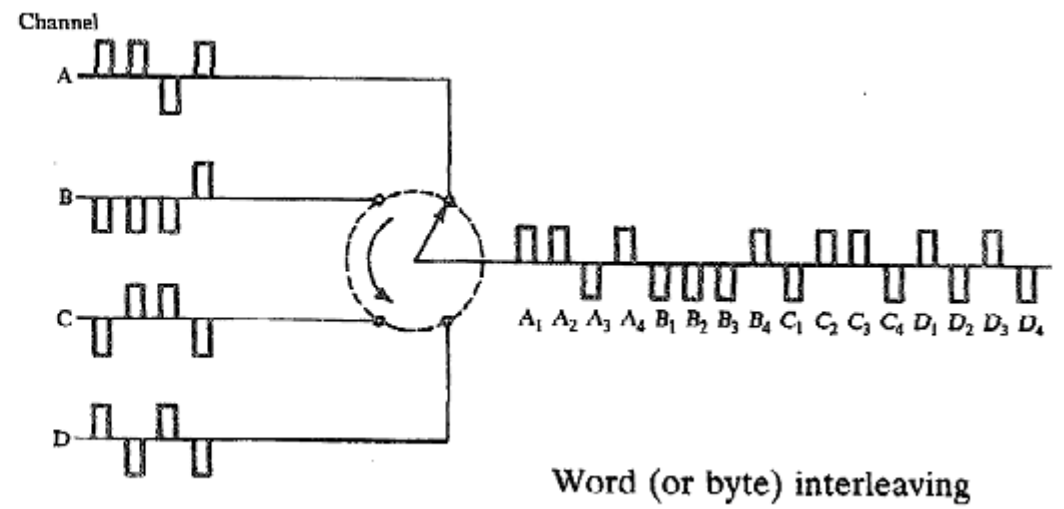
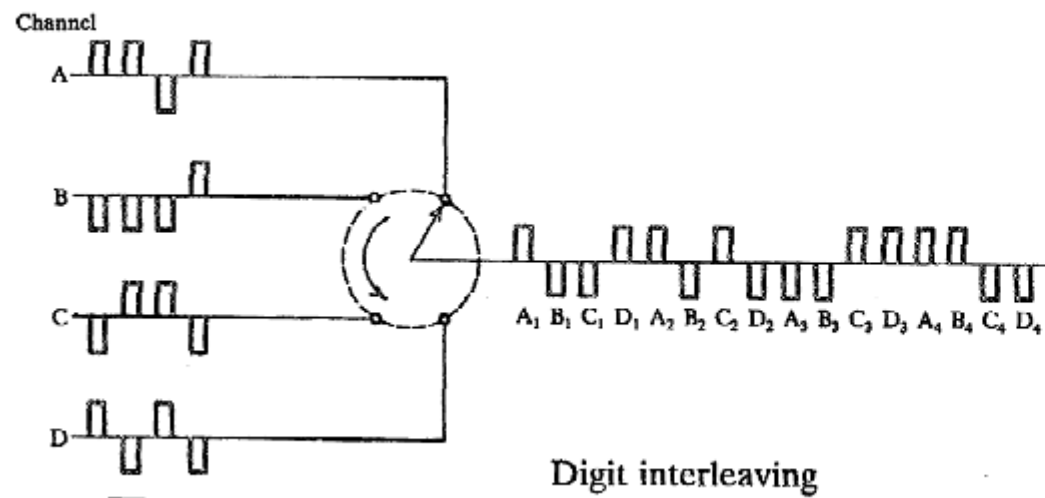

Syn

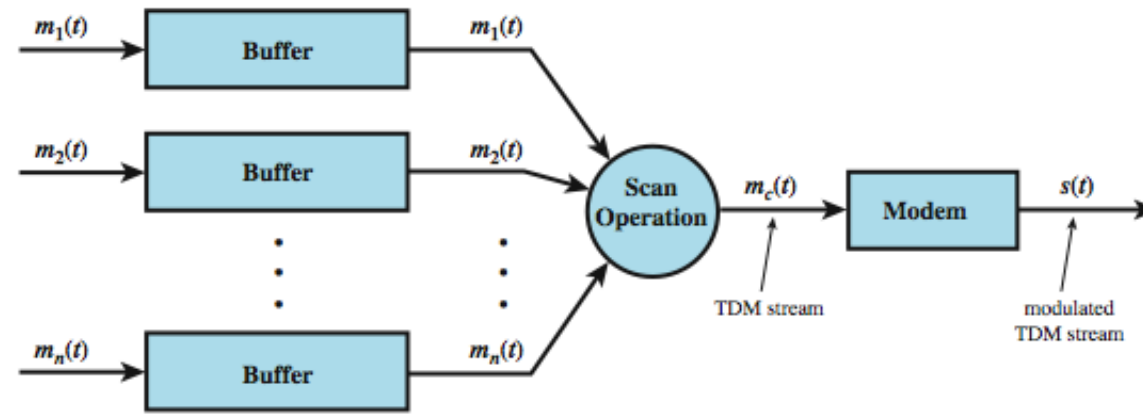

(a) Transmitter

TDM System Overview

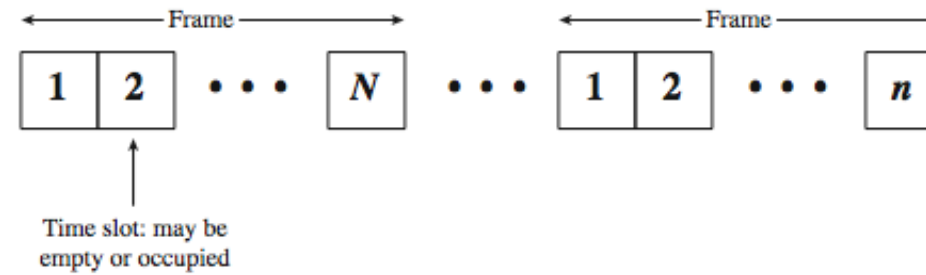

(b) TDM Frames

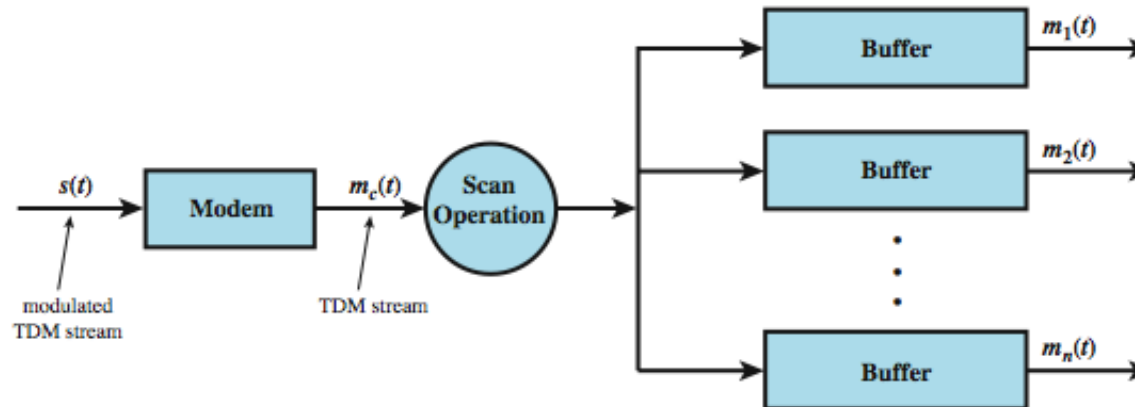

(c) Receiver

Framing

- ❑ Need to provide synchronizing mechanism between source and destination
- ❑ Added-digit framing
 - one control bit added to each TDM frame
 - identifiable bit pattern, from frame to frame, is used as “control channel”
 - e.g. alternating 01010101...unlikely on a data channel

Digital Carrier Systems/Standards

- ❑ Long-distance links use TDM hierarchy
- ❑ AT&T (USA) and ITU-T (International) variants
- ❑ US system based on DS-1 format
- ❑ Can carry mixed voice and data signals
- ❑ DS-1 multiplexes 24 channels into one frame
- ❑ Each frame contains 8 bits per channel plus a framing bit: $24 \times 8 + 1 = 193$ bits
- ❑ Each voice channel contains one word of digitized data (PCM, 8000 samples per sec)
- ❑ A total data rate of $8000 \times 193 = 1.544$ Mbps
- ❑ Can interleave DS-1 channels for higher rates
 - DS-2 is four DS-1 at 4×1.544 Mbps = 6.312 Mbps

DS-1 Transmission Format

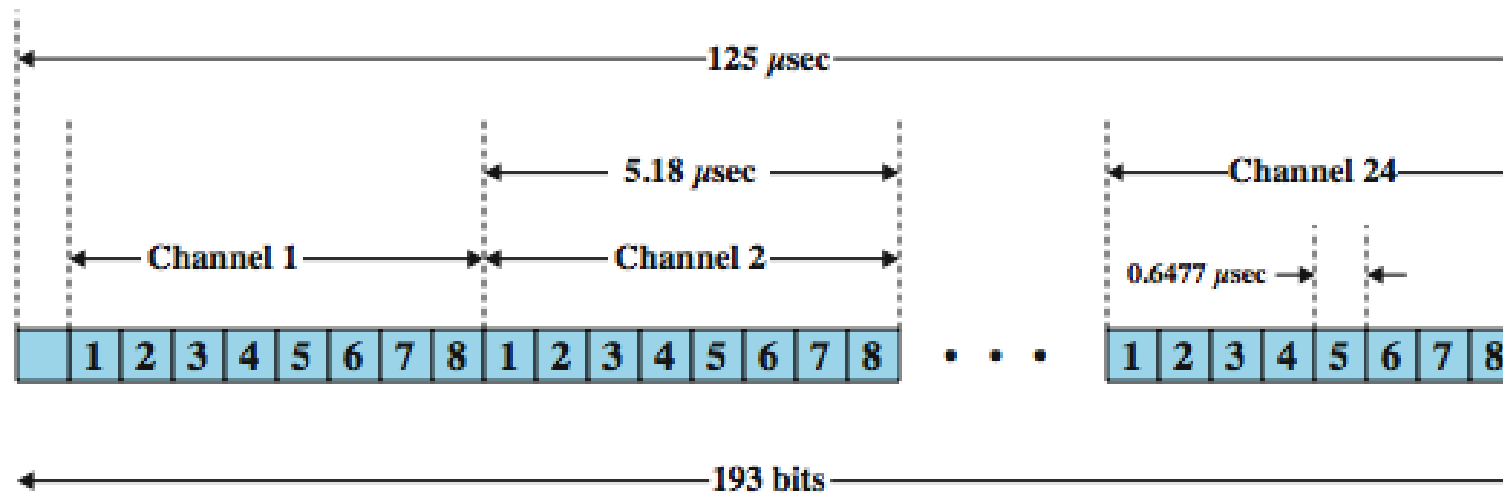

Notes:

1. The first bit is a framing bit, used for synchronization.
2. Voice channels:
 - 8-bit PCM used on five of six frames.
 - 7-bit PCM used on every sixth frame; bit 8 of each channel is a signaling bit.
3. Data channels:
 - Channel 24 is used for signaling only in some schemes.
 - Bits 1-7 used for 56 kbps service
 - Bits 2-7 used for 9.6, 4.8, and 2.4 kbps service.

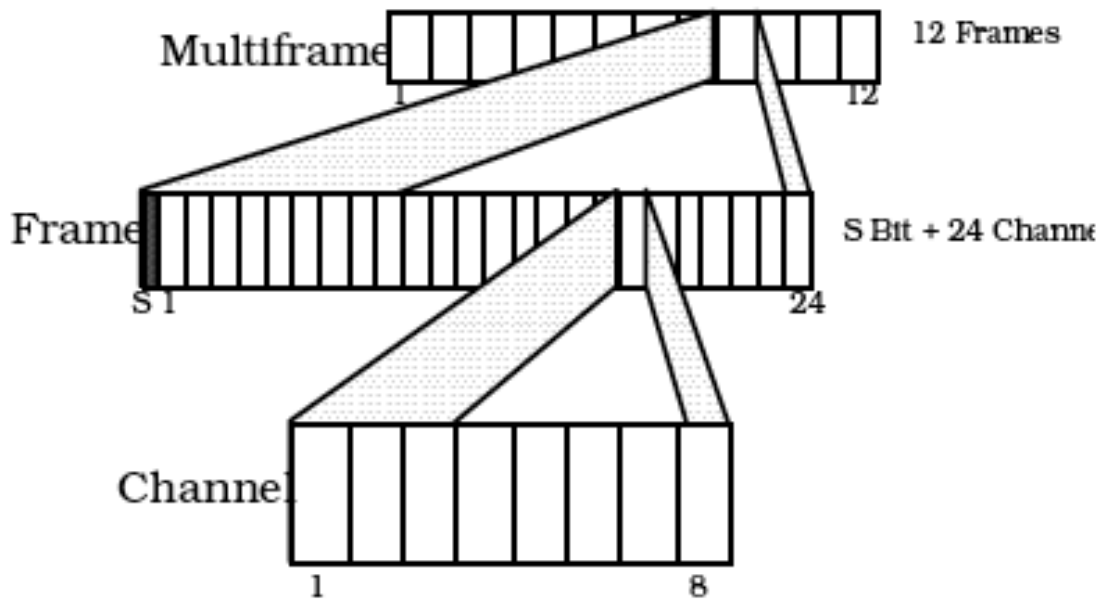

There are 8 thousand S bits per second

Frame	1	2	3	4	5	6	7	8	9	10	11	12
S Bit	1	0	0	0	1	1	0	1	1	1	0	0

Frequency Division Multiplexing

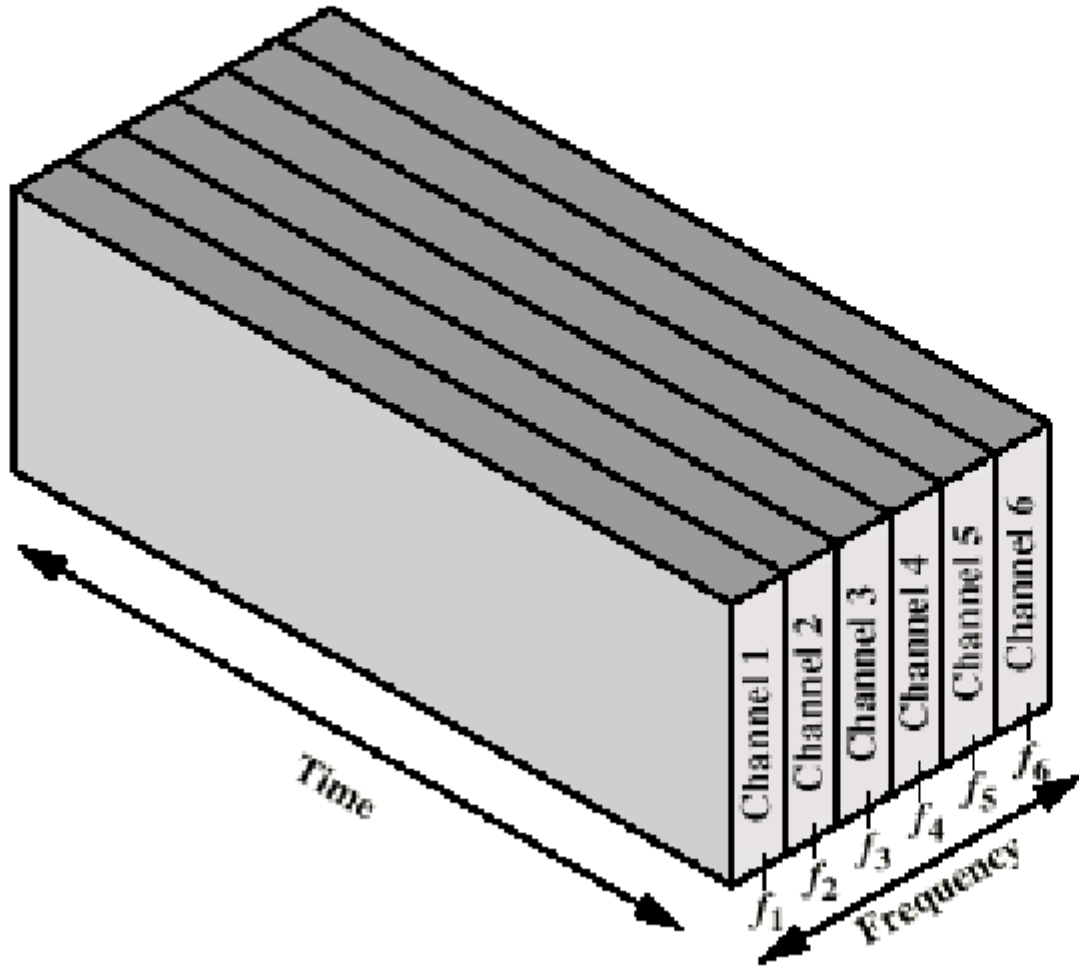

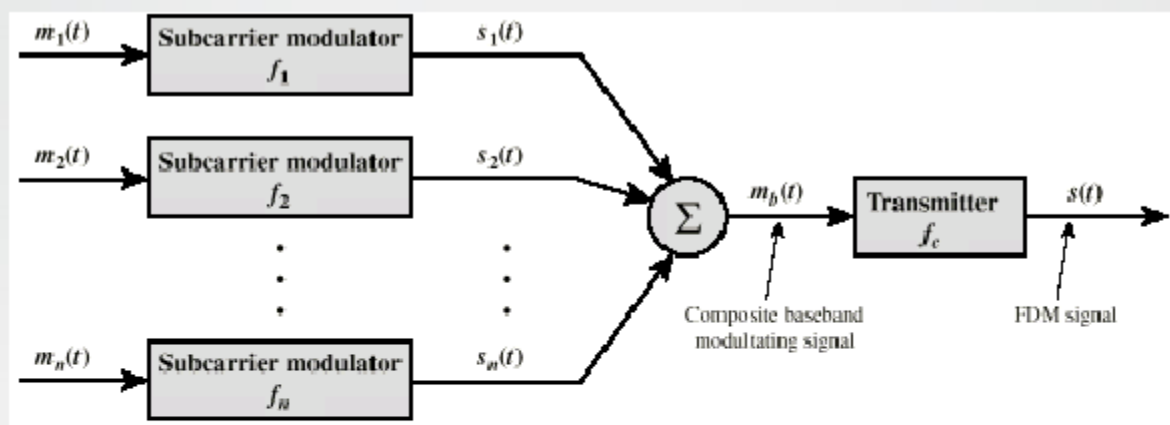

(a) Transmitter

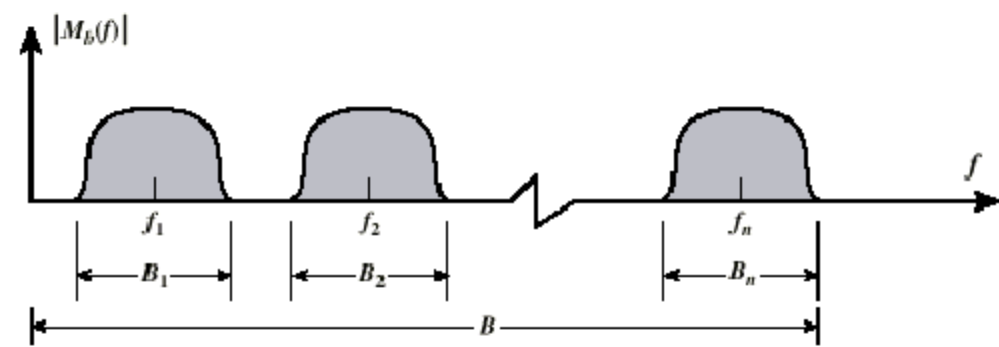

(b) Spectrum of composite baseband modulating signal

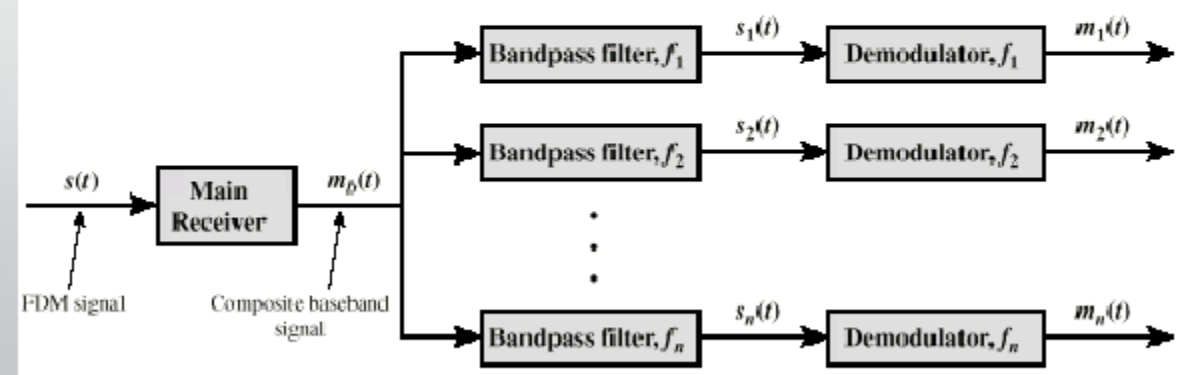

(c) Receiver

Time Division Multiplexing

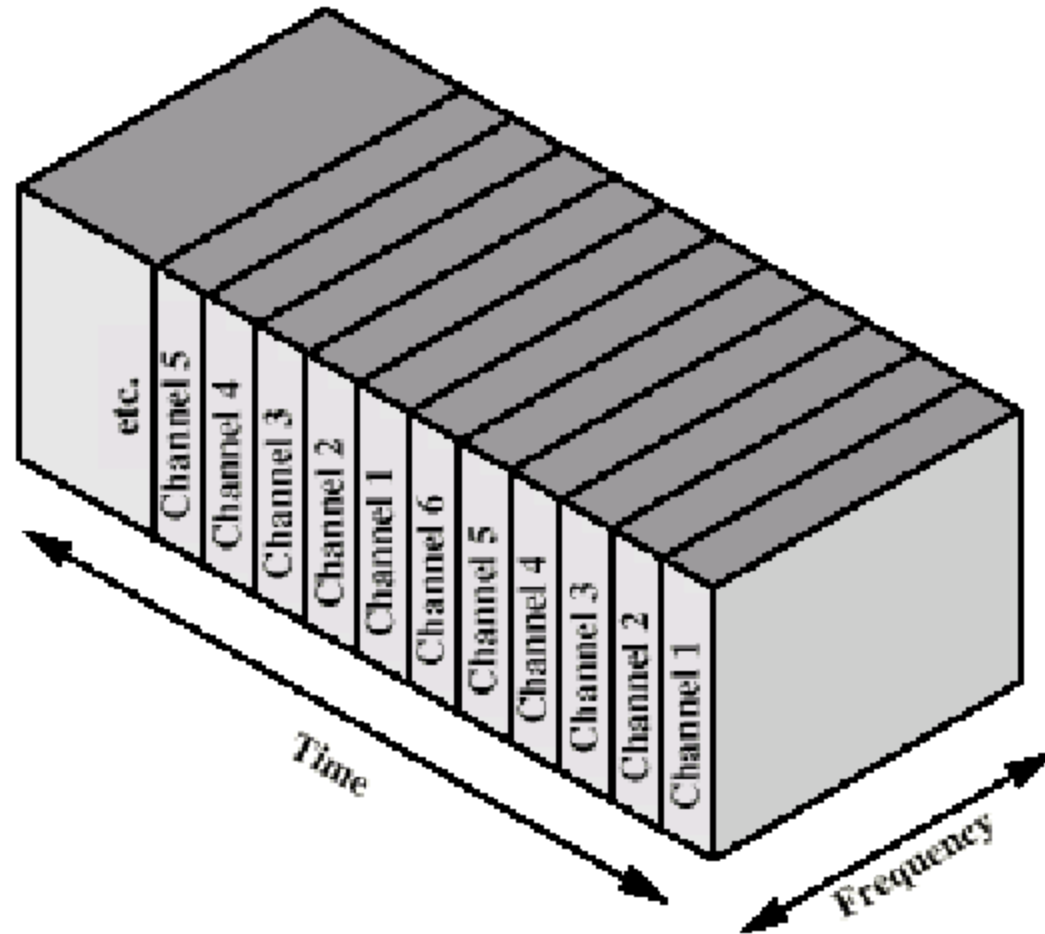

Time-Division Multiplexing

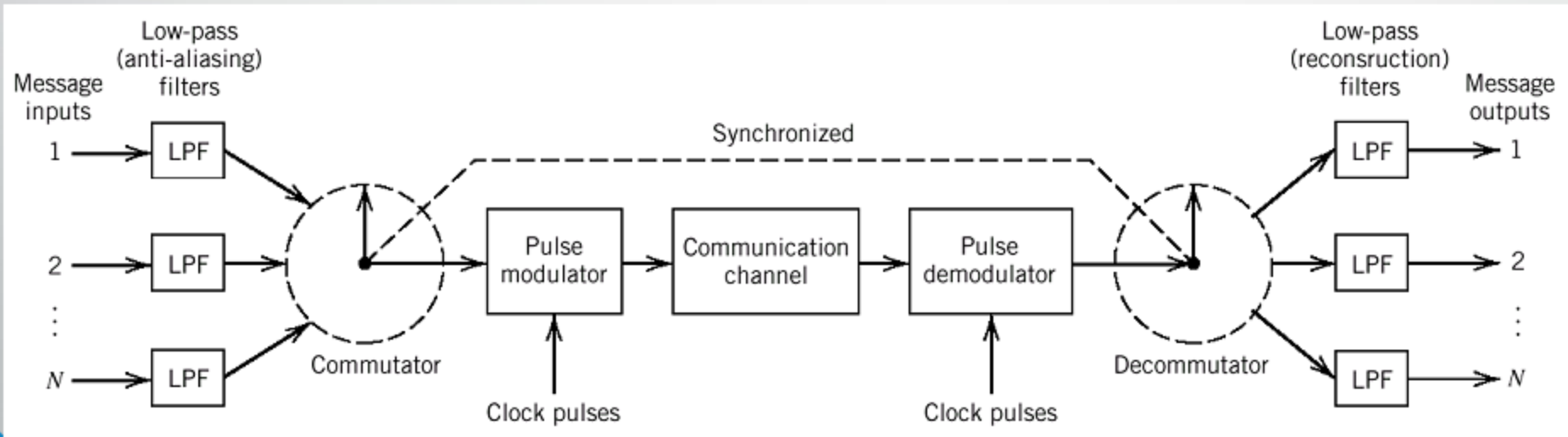
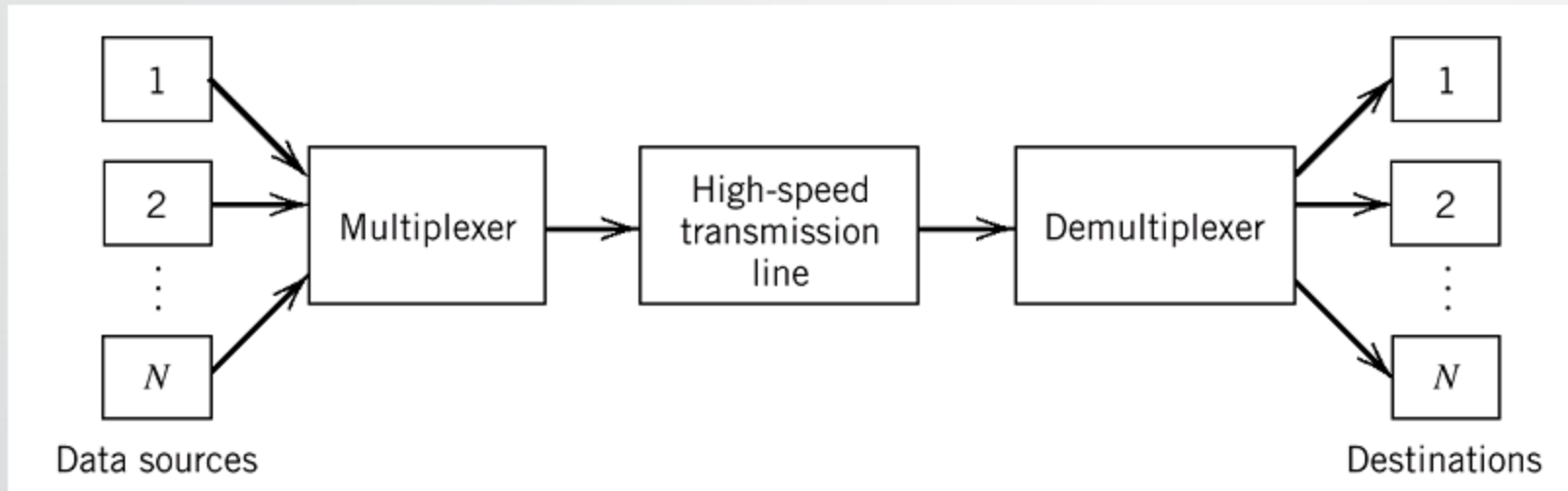
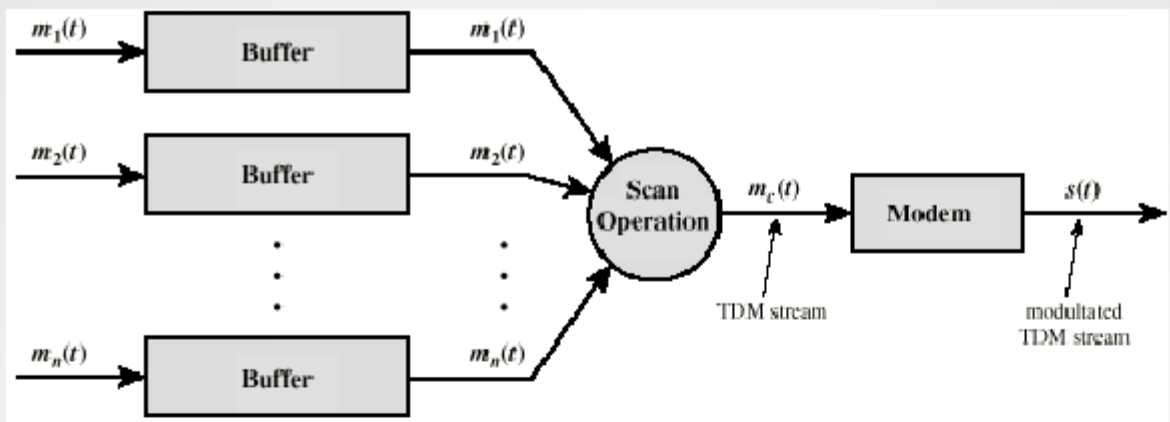
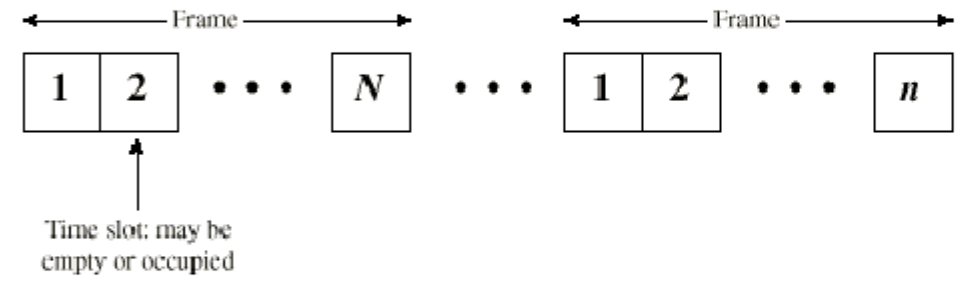

Figure Block diagram of TDM system.



(a) Transmitter



(b) TDM Frames

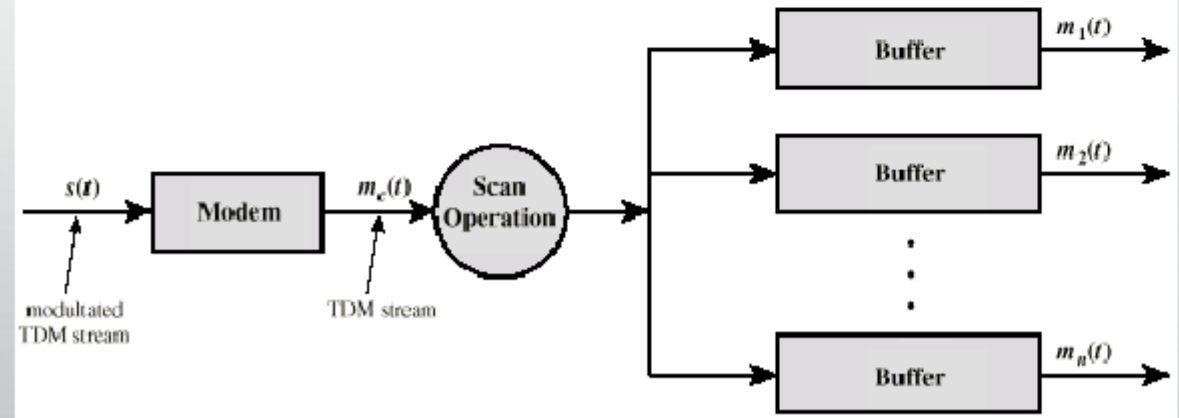

(c) Receiver

Digital Carrier Systems

- Hierarchy of TDM
- USA/Canada/Japan use one system
- ITU-T use a similar (but different) system
- US system based on DS-1 format
- Multiplexes 24 channels
- Each frame has 8 bits per channel plus one framing bit
- 193 bits per frame

Digital Carrier Systems (2)

- For voice each channel contains one word of digitized data (PCM, 8000 samples per sec)
 - Data rate $8000 \times 193 = 1.544 \text{ Mbps}$
 - Five out of six frames have 8 bit PCM samples
 - Sixth frame is 7 bit PCM word plus signaling bit
 - Signaling bits form stream for each channel containing control and routing info
- Same format for digital data
 - 23 channels of data
 - 7 bits per frame plus indicator bit for data or systems control
 - 24th channel is sync

DS₁/T₁/E₁

- **Digital signal 1 (DS₁)**, also known as **T₁** is a [T-carrier](#) signaling scheme devised by [Bell Labs](#). DS₁ is a widely used standard in [telecommunications](#) in [North America](#) and [Japan](#) to transmit voice and data between devices. **E₁** is used in place of **T₁** outside of North America and Japan. Technically, DS₁ is the transmission protocol used over a physical T₁ line; however, the terms "DS₁" and "T₁" are often used interchangeably.
- A DS₁ [circuit](#) is made up of twenty-four DS₀
- DS₁: $(8 \text{ bits/channel} * 24 \text{ channels/frame} + 1 \text{ framing bit}) * 8000 \text{ frames/s} = 1.544 \text{ Mbit/s}$
- A E₁ is made up of 32 DS₀
- The line data rate is 2.048 [Mbit/s](#) which is split into 32 time slots, each being allocated 8 bits in turn. Thus each time slot sends and receives an 8-bit sample 8000 times per second ($8 * 8000 * 32 = 2,048,000$). 2.048Mbit/s

DS-1 Transmission Format

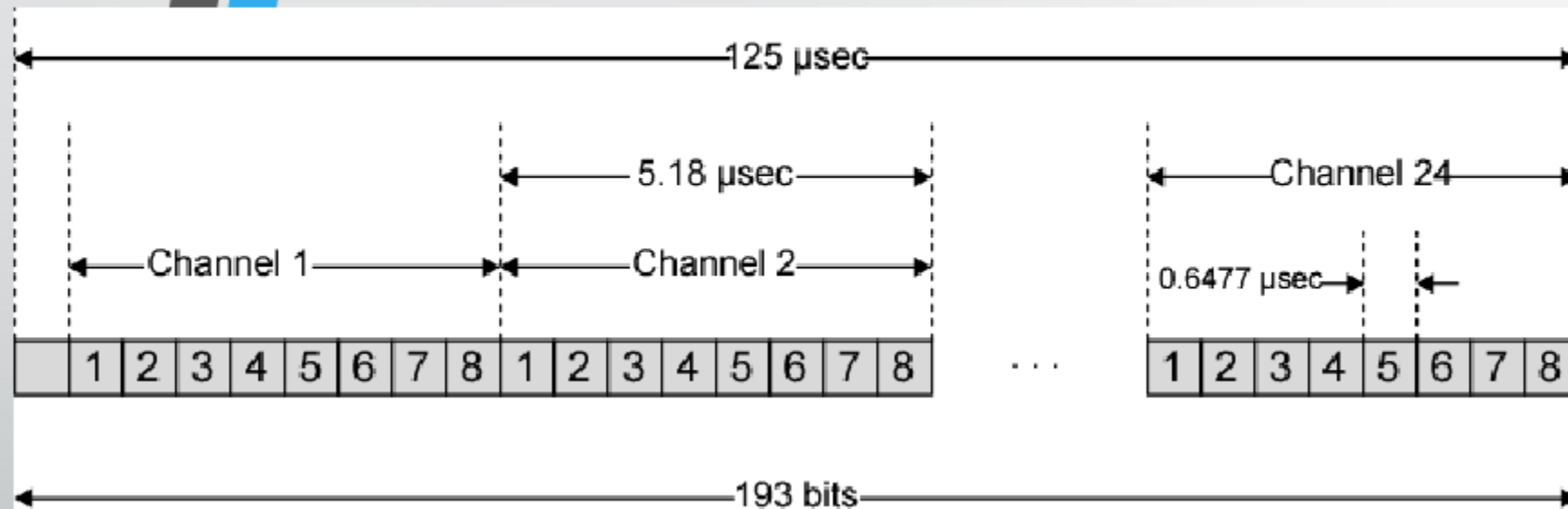

Notes:

1. The first bit is a framing bit, used for synchronization.
2. Voice channels:
 - 8-bit PCM used on five of six frames.
 - 7-bit PCM used on every sixth frame; bit 8 of each channel is a signaling bit.
3. Data channels:
 - Channel 24 is used for signaling only in some schemes.
 - Bits 1-7 used for 56 kbps service
 - Bits 2-7 used for 9.6, 4.8, and 2.4 kbps service.

Differential PCM

- Concept of *differential* encoding is of great importance in communications
- The underlying idea is not to look at samples individually but to look at past values as well.
- Often, samples change very little thus a substantial compression can be achieved

Why differential?

- Let's say we have a DC signal and blindly go about PCM-encoding it. Is it smart?

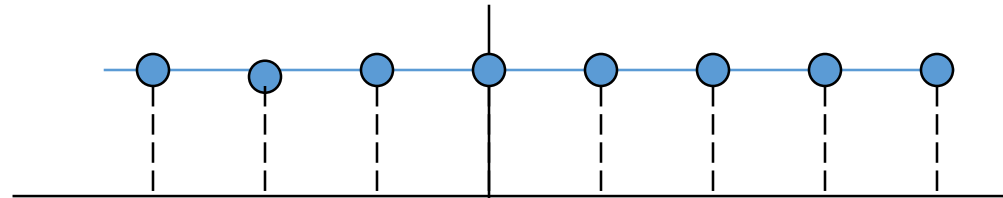

- Clearly not. What we have failed to realize is that samples don't change. We can send the first sample and tell the receiver that the rest are the same

Definition of differential encoding

- We can therefore say that in differential encoding, what is recorded and ultimately transmitted is the *change* in sample amplitudes not their absolute values
- We should send only what is NEW.

Where is the saving?

- Consider the following two situations

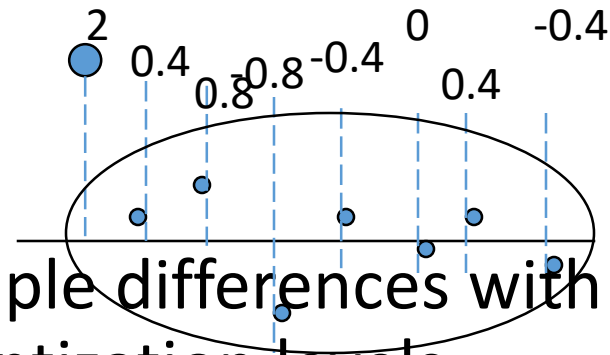
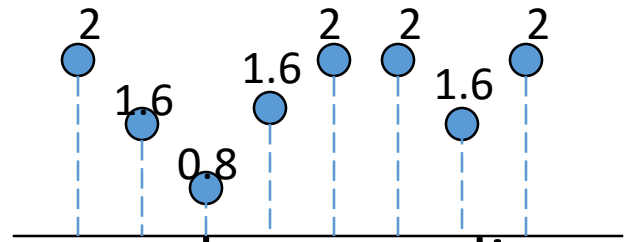

- The right samples are adjacent sample differences with much smaller dynamic range requiring fewer quantization levels

Implementation of DPCM:prediction

- At the heart of DPCM is the idea of *prediction*
- Based on $n-1$ previous samples, encoder generates an estimate of the n th sample. Since the n th sample is known, prediction error can be found. This error is then transmitted

Illustrating prediction

- Here is what is happening at the transmitter

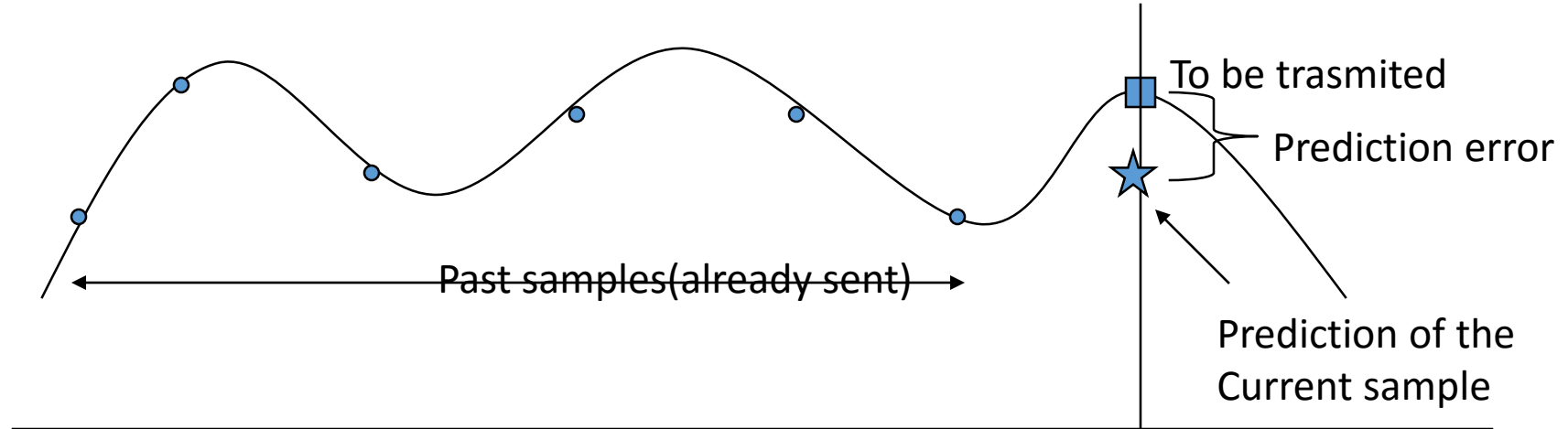

Only Prediction error is sent

What does the receiver do?

- Receiver has the identical prediction algorithm available to it. It has also received all previous samples so it can make a prediction of its own
- Transmitter helps out by supplying the prediction error which is then used by the receiver to update the predicted value

Interesting speculation

- What if our power of prediction was perfect? In other words, what if we could predict the next sample with no error?. What kind of communication system would be looking at?

Prediction error

- Let $m(t)$ be the message and T_s sample interval, then *prediction error* is given

$$e(nT_s) = m(nT_s) - \hat{m}(nT_s)$$

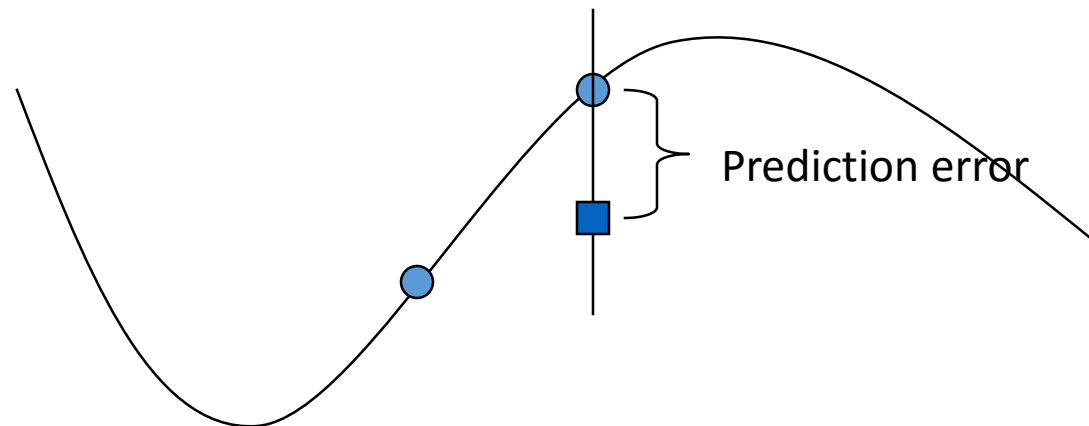

Prediction filter

- Prediction is normally done using a weighted sum of N previous samples

$$\hat{m}(nT_s) = \sum_{i=1}^N w_i m((n-i)T_s)$$

- The quality of prediction depends on the good choice of weights w_i

Finding the optimum filter

- How do you find the “best” weights?
- Obviously, we need to minimize the prediction error. This is done statistically

$$\underset{\text{over } w}{\text{Min}} \{ \bar{e}^2(nT_s) \}$$

- Choose a set of weights that gives the lowest (on average) prediction error

Prediction gain

- Prediction provides an SNR improvement by a factor called prediction gain

$$G_p = \frac{\sigma_M^2}{\sigma_e^2} = \frac{\text{message power}}{\text{prediction error power}}$$

How much gain?

- On average, this gain is about 4-11 dB.
- Recall that 6 dB of SNR gain can be exchanged for 1 bit per sample
- At 8000 samples/sec(for speech) we can save 1 to 2 bits per sample thus saving 8-16 Kb/sec.

DPCM encoder

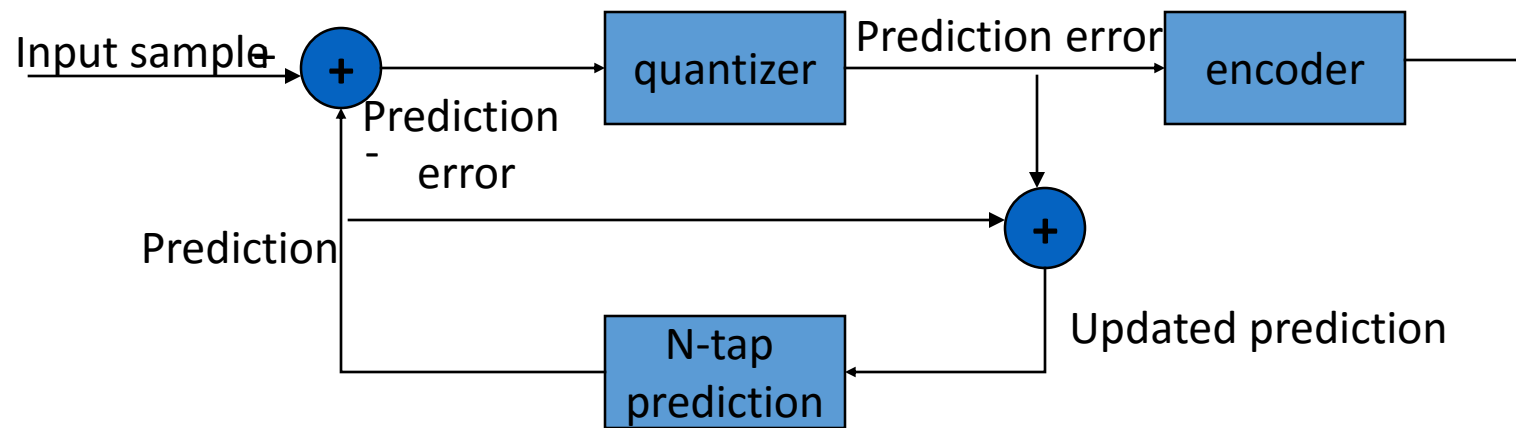

- Prediction error is used to correct the estimate in time for the next round of prediction

Delta modulation (DM)

- DM is actually a very simplified form of DPCM
- In DM, prediction of the next sample is simply the previous sample

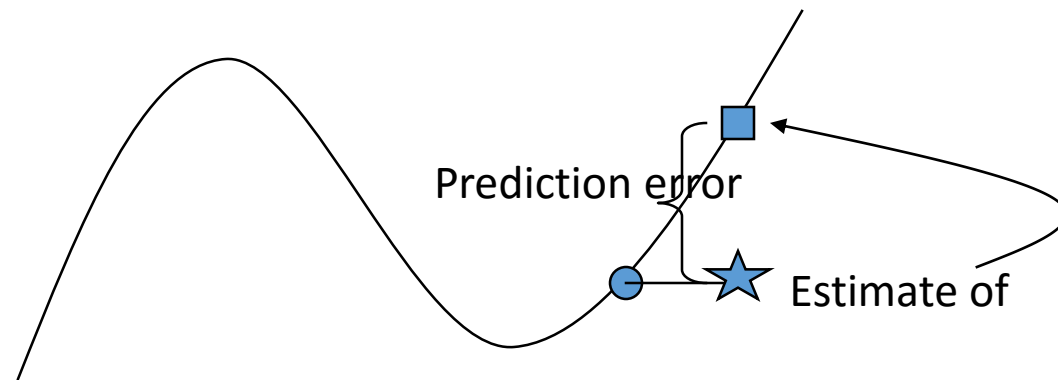

DM encoder-diagram

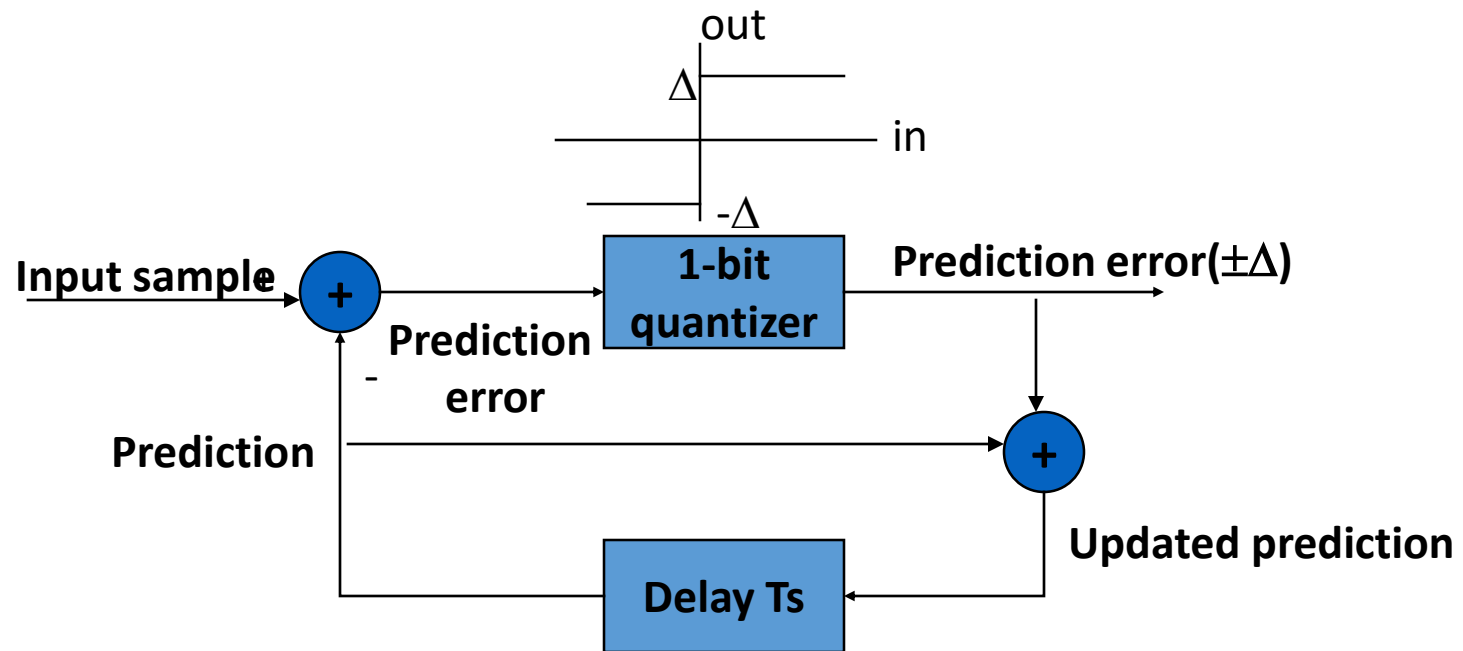

DM encoder operation

- Prediction error generates $\pm\Delta$ at the output of quantizer
- If error is positive, it means prediction is below sample value in which case the estimate is updated by $+\Delta$ for the next step

Slope overload effect

- Signal rises faster than prediction: Δ too small

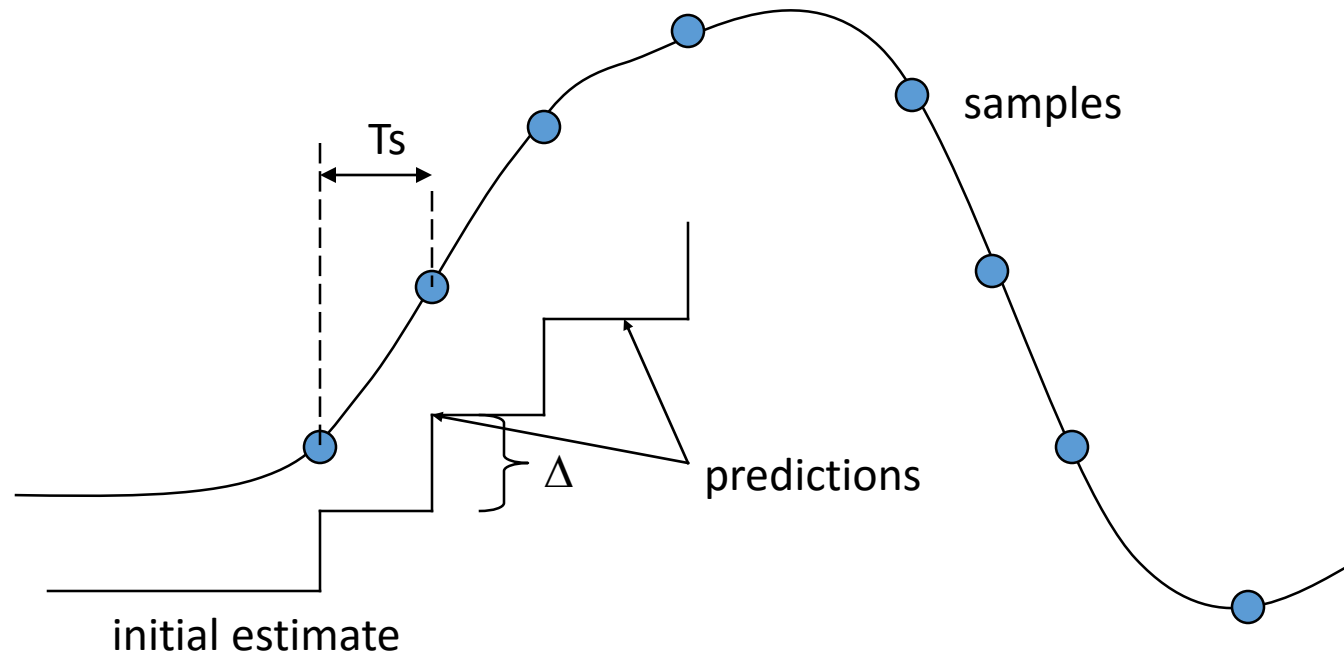

Steady state: granular noise

- Prediction can track the signal; prediction error small

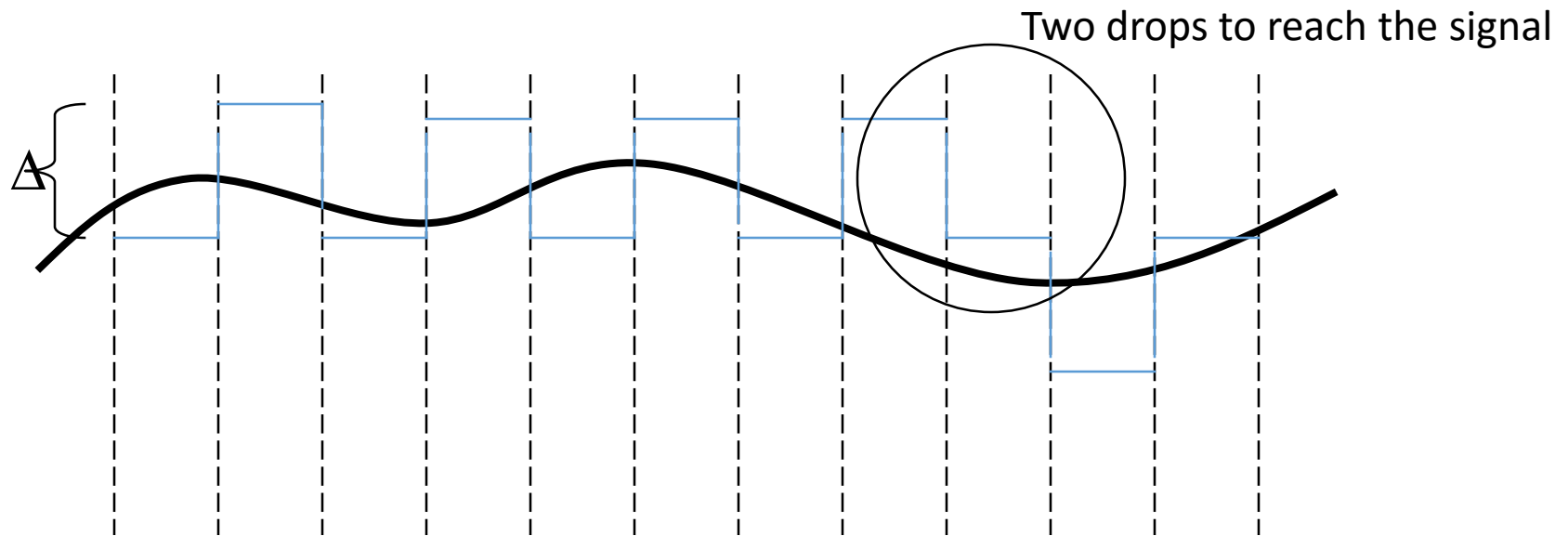

Shortcomings of DM

- It is clearly the prediction stage that is lacking
- Samples must be closely taken to insure that “previous-sample” prediction algorithm is reasonably accurate
- This means higher sample rates

Multiplexing

- Concurrent communications calls for some form of multiplexing.
There are 3 categories
 - FDMA(frequency division multiple access)
 - TDMA(time division multiple access)
 - CDMA(code division multiple access)
- All 3 enjoy a healthy presence in the communications market

Delta Modulation

- $m(t) \rightarrow$ samples (analog amplitude) \rightarrow difference \rightarrow binary
or $m(t) \rightarrow$ difference \rightarrow binary \rightarrow samples
- Operations:

$$(1) \quad d(t) = m(t) - m_s(t)$$

$$(2) \quad \Delta(t) = \text{threshold}(d(t)) = \begin{cases} \delta_0, & d(t) \geq 0 \\ -\delta_0, & d(t) < 0 \end{cases}$$

$$(3) \quad x_c(t) = \text{samples of } \Delta(t) = \Delta(t) \cdot \sum_{n=-\infty}^{\infty} \delta(t - nT_s) = \sum_{n=-\infty}^{\infty} \Delta(nT_s) \delta(t - nT_s)$$

$$(4) \quad m_s(t) = \sum_{n=-\infty}^{\infty} \Delta(nT_s) \int^t \delta(\alpha - nT_s) d\alpha$$

DM Signal Generation

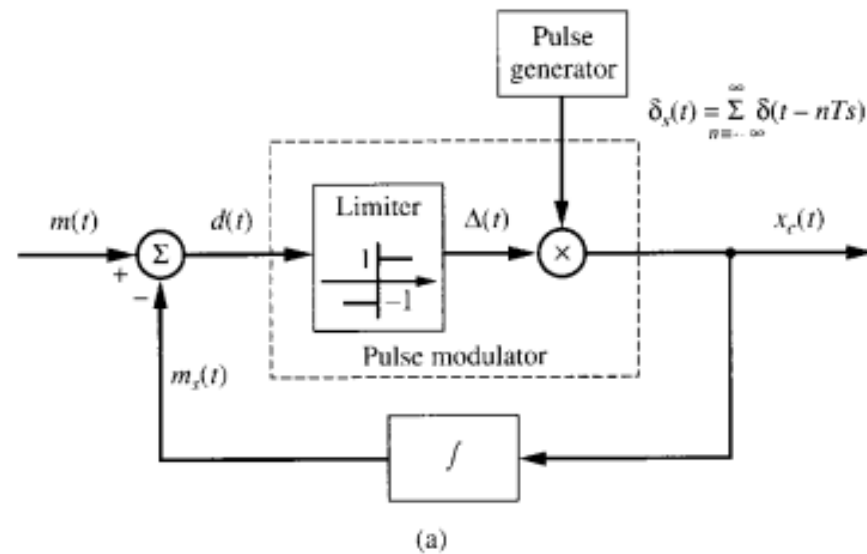
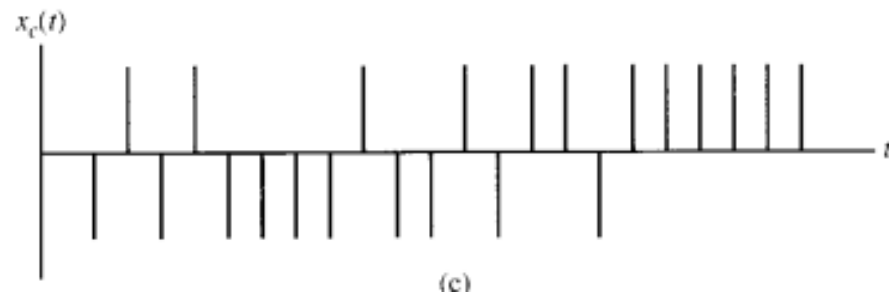
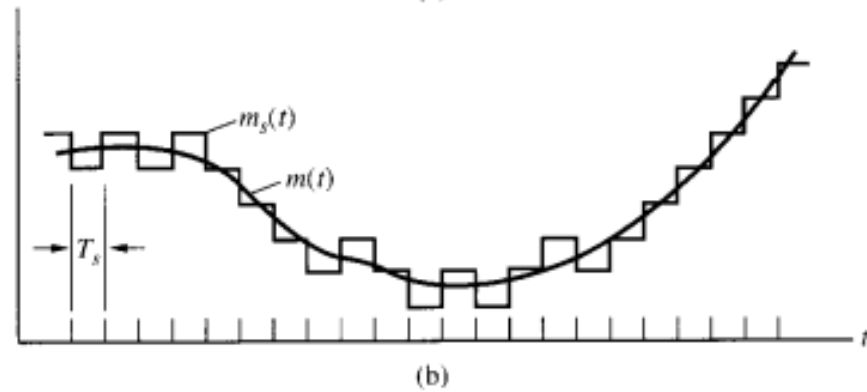
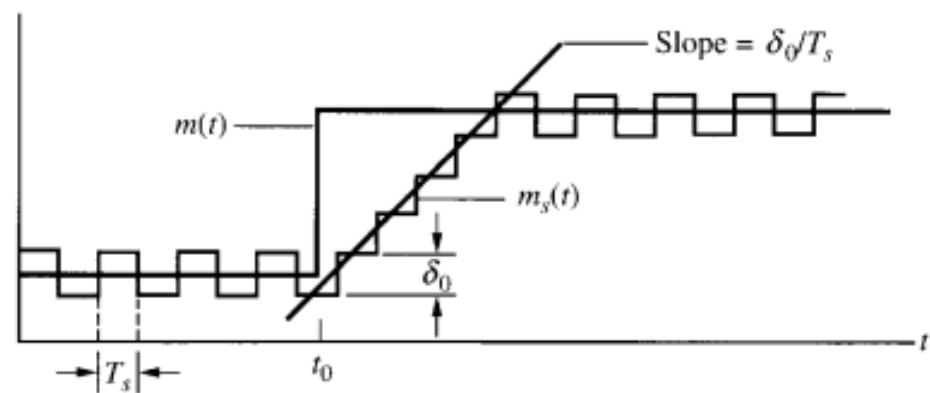

Figure 3.59
Delta modulation. (a) Delta modulator. (b) Modulation waveform and staircase approximation. (c) Modulator output.



Slope Overload

- The message signal $m(t)$ has a slope greater than can be followed by the stair-step approximation $m_s(t)$.
- Assume step-size = $\delta_0 \rightarrow$ slope (max) = δ_0/T_s



(a)

Figure 3.60

Illustration of slope overload.

(a) Illustration of $m(t)$ and $m_s(t)$ with step change in $m(t)$. (b) Error between $m(t)$ and $m_s(t)$.

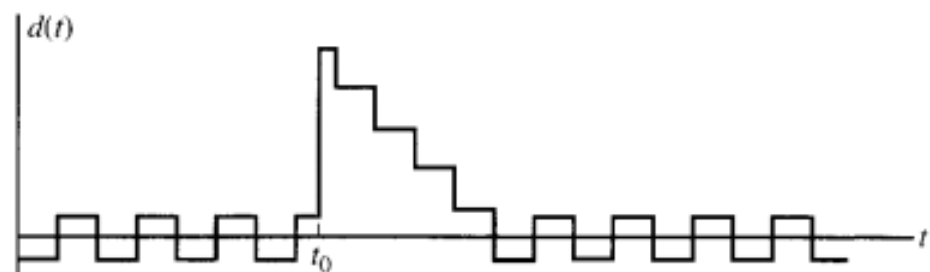

(b)

Solution to Overload

- **Adaptive delta modulation** -- adjust the step-size δ_0 based on $x_c(t)$.
- Idea: If $m(t) \approx$ constant, $x_c(t)$ alternates in sign
 \Rightarrow make $\delta_0 \downarrow$.
If $m(t) \uparrow$ (or \downarrow) rapidly, $x_c(t)$ has the same polarity
 \Rightarrow make $\delta_0 \uparrow$.
- Method: Detect the “trend” of signal

Adaptive DM

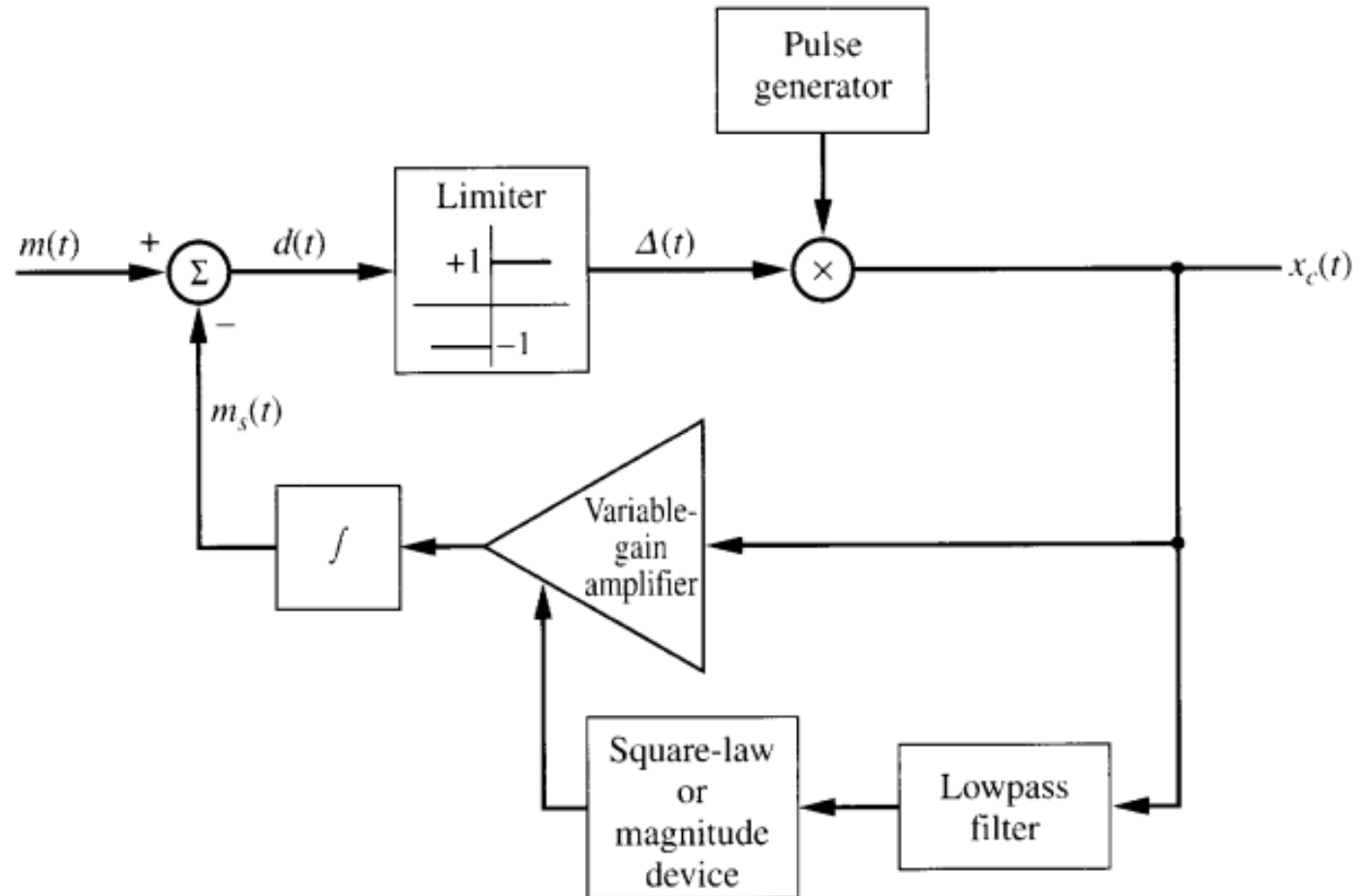

ADM Receiver

- Transmit step-size or regenerate the step-size at the receiver according to pre-decided “rules”.

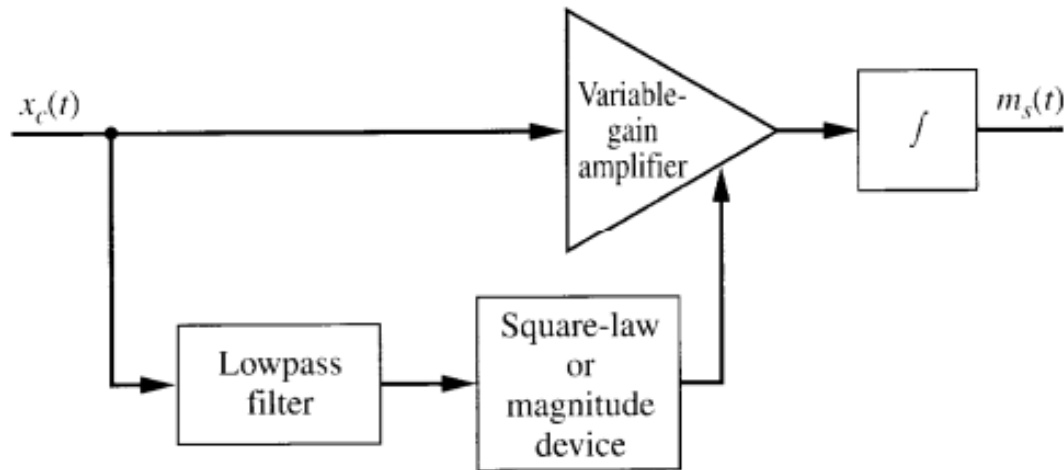

Figure 3.62
Adaptive DM receiver.

Basis for finding PCM bandwidth

- Nyquist said in a channel with transmission bandwidth B_T , we can transmit at most $2B_T$ pulses per second:

$$R(\text{pulses/second}) < 2B_T(\text{Hz})$$

Or

$$B_T(\text{Hz}) > R/2(\text{pulses/second})$$

Transmission over phone lines

- Analog phone lines are limited to 4KHz in bandwidth, what is the fastest pulse rate possible?

$$R < 2BT = 2 \times 4000 = 8000 \text{ pulses/sec}$$

- That's it? Modems do a bit faster than this!
- One way to raise this rate is to stuff each pulse with multiple bits. More on that later

Accommodating a digital source

- A source is generating a million bits/sec. What is the minimum required transmission bandwidth.

$$B_T > R/2 = 10^6/2 = 500 \text{ KHz}$$

PCM bit rate

- The bit rate at the output of encoder is simply the following product
 - $R(\text{bits/sec}) = n(\text{bits/sample}) \times f_s(\text{samples/sec})$

$$R = n f_s \text{ bits/sec}$$

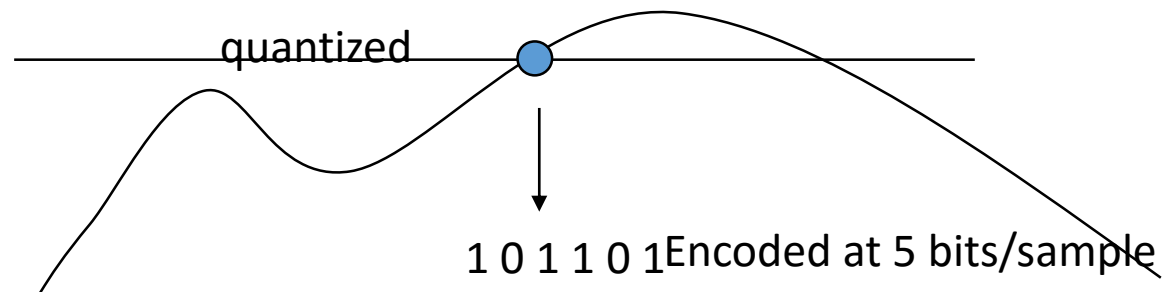

PCM bandwidth

- But we know sampling frequency is $2W$. Substituting $f_s=2W$ in $R=n f_s$

$$R=2nW \text{ (bits/sec)}$$

- We also had $B_T > R/2$. Replacing R we get

$$B_T > nW$$

Comments on PCM bandwidth

- We have established a lower bound(min) on the required bandwidth.
- The cost of doing PCM is the large required bandwidth. The way we can measure it is
- Bandwidth expansion quantified by

$$B_T/W > n \text{ (bits/sample)}$$

Bandwidth expansion factor

- Similar to FM, there is a bandwidth expansion factor relative to baseband, i.e.

$$\beta = B_T/W > n$$

- Let's say we have 8 bits/sample meaning it takes , at a minimum, 8 times more than baseband bandwidth to do PCM

PCM bandwidth example

- Want to transmit voice ($\sim 4\text{KHz}$) using an 8-bit PCM. How much bandwidth is needed?
- We know $W=4\text{KHz}$, $f_s=8\text{ KHz}$ and $n=8$.

 $B_T > nW = 8 \times 4000 = 32\text{KHz}$

- This is the minimum PCM bandwidth under “ideal” conditions. Ideal has to do with pulse shape used

Bandwidth-power exchange

- We said using finer quantization (more bits/sample) enhances sqnr because

$$(\text{sqnr})_{\text{dB}} = \alpha + 6n \text{ dB}$$

- At the same time we showed bandwidth increases linearly with n . So we have a trade-off

sqnr improvement

- Let's say we increase n by 1 from 8 to 9 bits/sample. As result, sqnr increases by 6 dB

$$\text{sqnr} = \alpha + 6 \times 8 = \alpha + 48$$

$$\text{sqnr} = \alpha + 6 \times 9 = \alpha + 54$$

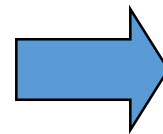

+6dB

Bandwidth increase

- Going from $n=8$ bits/sample, to 9 bits/sample, min. bandwidth rises from $8W$ to $9W$.
- If message bandwidth is 4 KHz, then

$B_T=32$ KHz for $n=8$

$B_T=36$ KHz for $n=9$

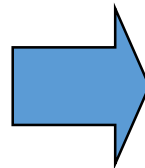

+4 KHz or 12.5% increase

Is it worth it?

- Let's look at the trade-off:
 - Cost in increased bandwidth: 12.5%
 - Benefit in increased sqnr: 6dB
- Every 3 dB means a doubling of the sqnr ratio. So we have quadrupled sqnr by paying 12.5% more in bandwidth

Another way to look at the exchange

- We provided 12.5% more bandwidth and ended up with 6 dB more sqnr.
- If we are satisfied with the sqnr we have, we can dial back *transmitted power* by 6 dB and suffer no loss in sqnr
- In other words, we have *exchanged* bandwidth for lower power

Similarity with FM

- PCM and FM are examples of wideband modulation. All such modulations provide bandwidth-power exchange but at different rates. Recall $\beta = B_T/W$
- FM..... $SNR \sim \beta^2$
- PCM..... $SNR \sim 2^{2\beta}$

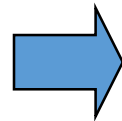

Much more sensitive to beta,
Better exchange

Complete PCM system design

- Want to transmit voice with average power of $1/2$ watt and peak amplitude 1 volt using 256 level quantizer. Find
 - sqnr
 - Bit rate
 - PCM bandwidth

Signal to quantization noise

- We had

$$\text{sqnr} = [3P/m_{\max}^2]L^2$$

We have $L=256$, $P=1/2$ and $m_{\max}=1$.

$$\text{sqnr} = 98304 \sim 50 \text{ dB}$$

PCM bitrate

- Bit rate is given by

$$R=2nW \text{ (bits/sec)}=2 \times 8 \times 4000=64 \text{ Kb/sec}$$

- This rate is a standard PCM voice channel
- This is why we can have 56K transmission over the digital portion of telephone network which can accomodating 64 Kb/sec.

PCM bandwidth

- We can really talk about minimum bandwidth given by

$$B_T |_{\min} = nW = 8 \times 4000 = 32 \text{ KHz}$$

- In other words, we need a minimum of 32 KHz bandwidth to transmit 64 KB/sec of data.

Realistic PCM bandwidth

- Rule of thumb to find the required bandwidth for digital data is that bandwidth=bit rate

$$B_T = R$$

- So for 64 KB/sec we need 64 KHz of bandwidth

One hertz per bit

