

10
5

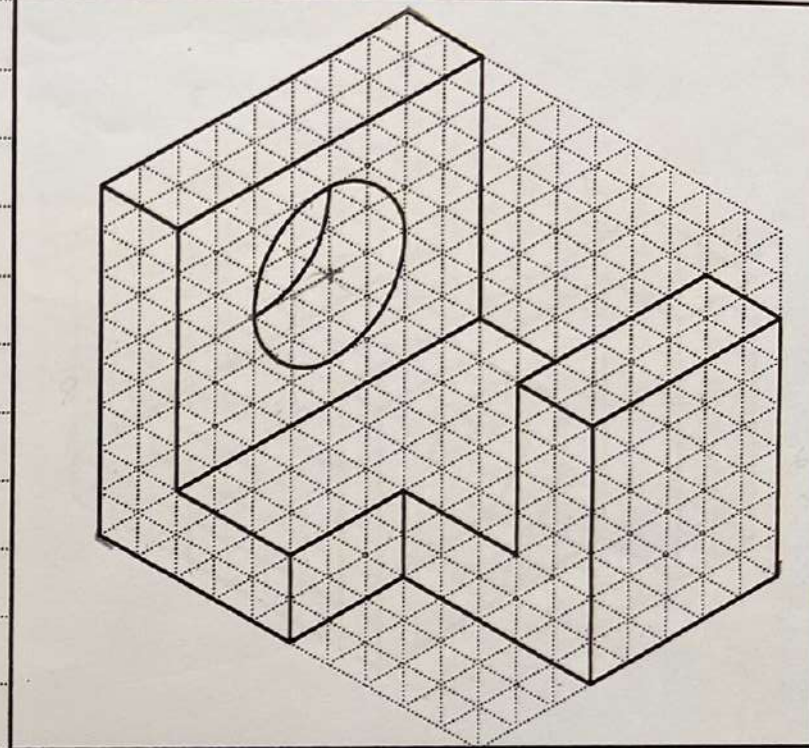

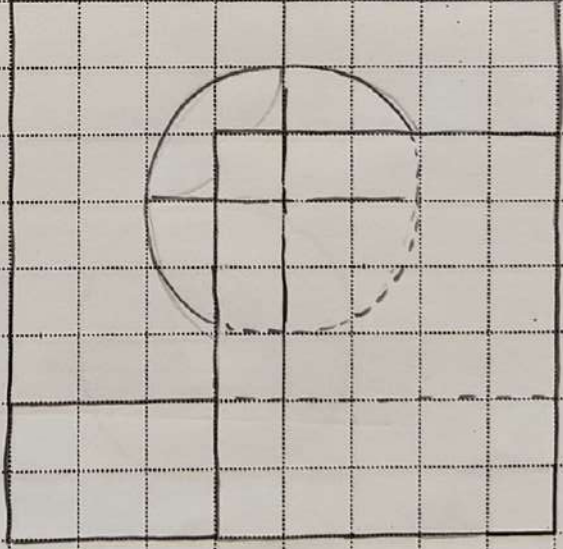

$\frac{w}{2}$

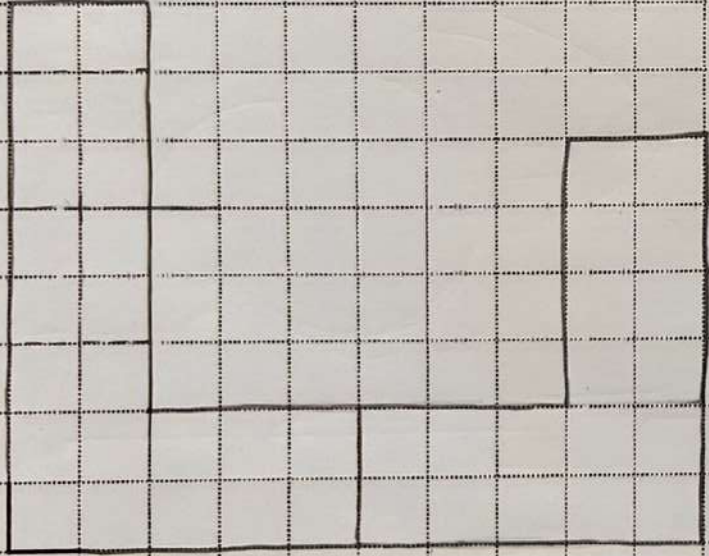
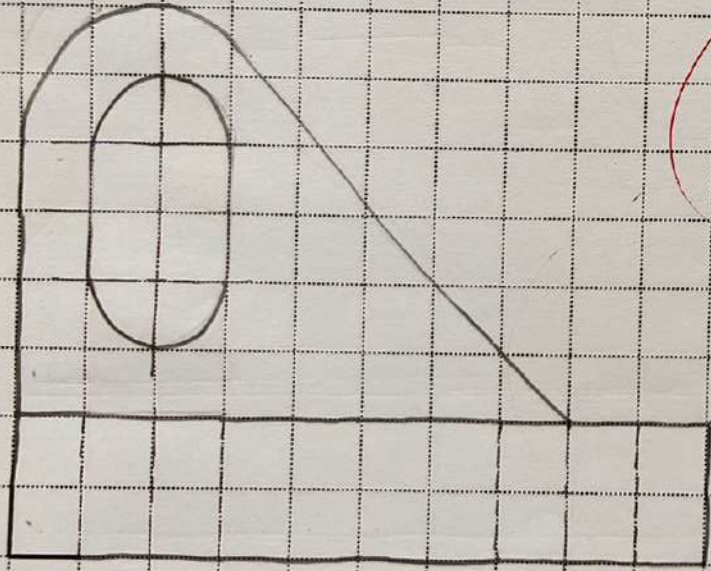
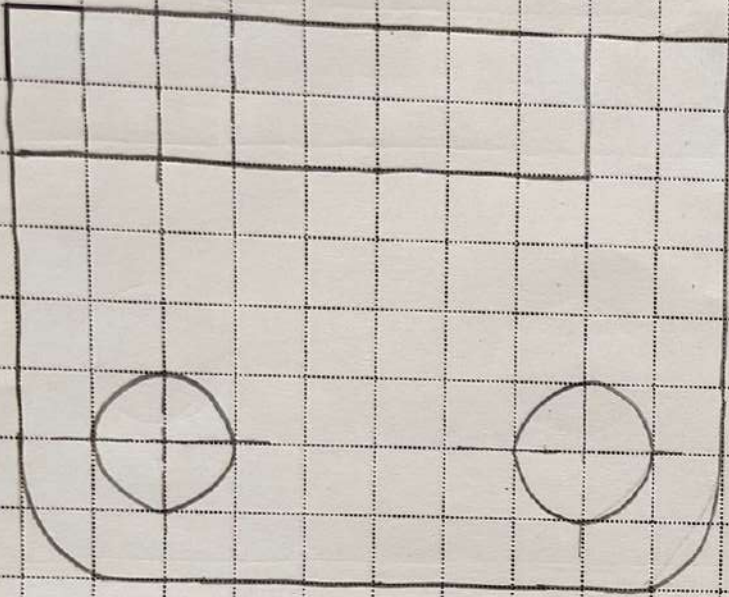
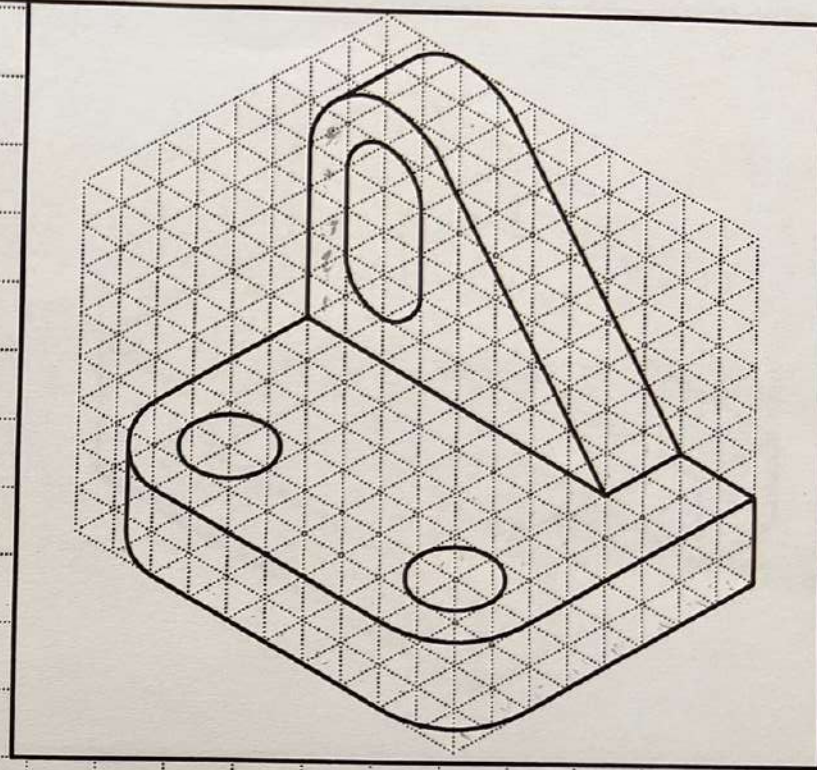
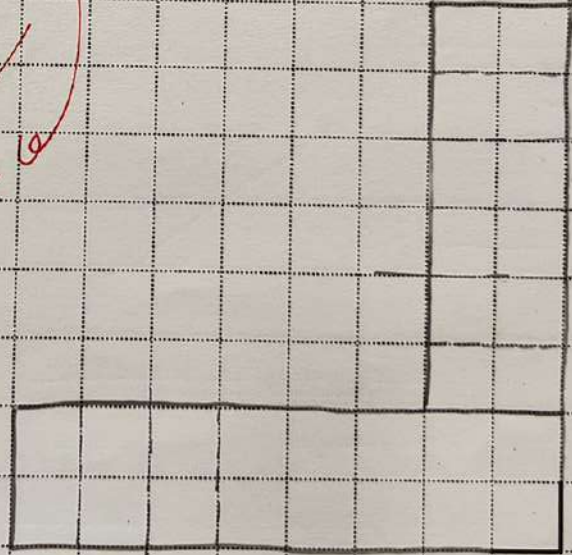

Name:

ID:

Sec:

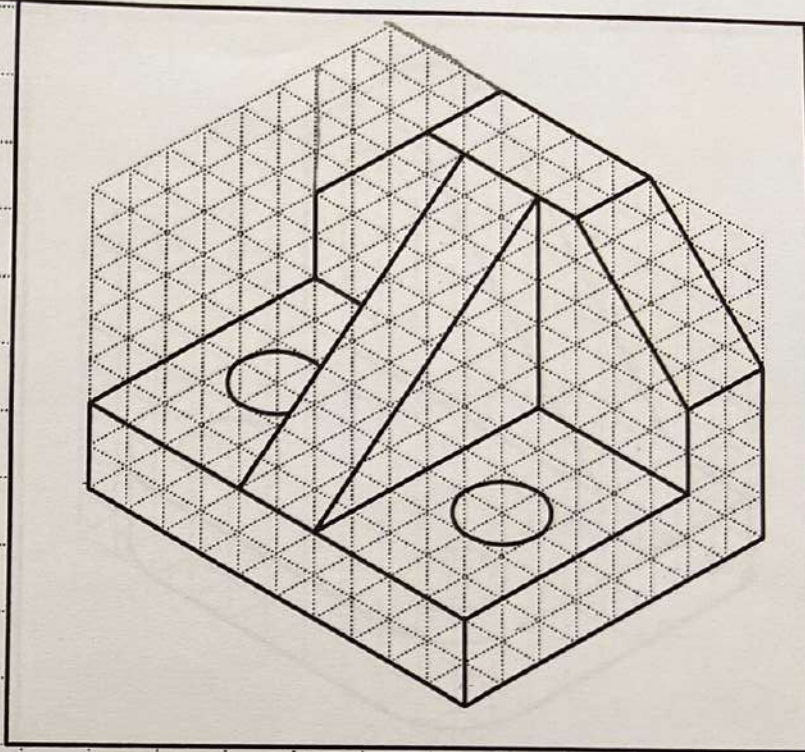
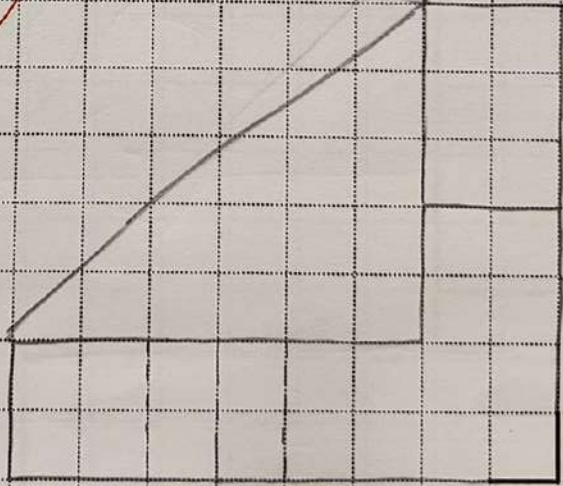
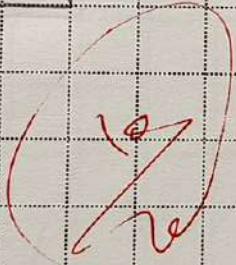
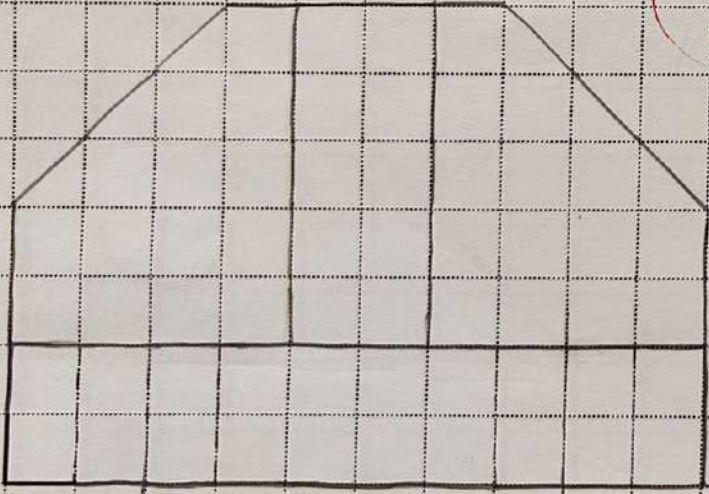
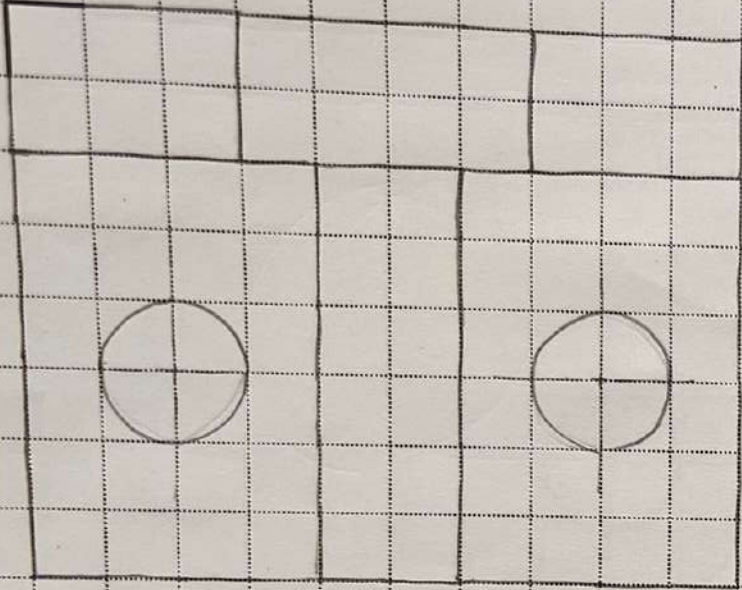

Name:

ID:

Sec:

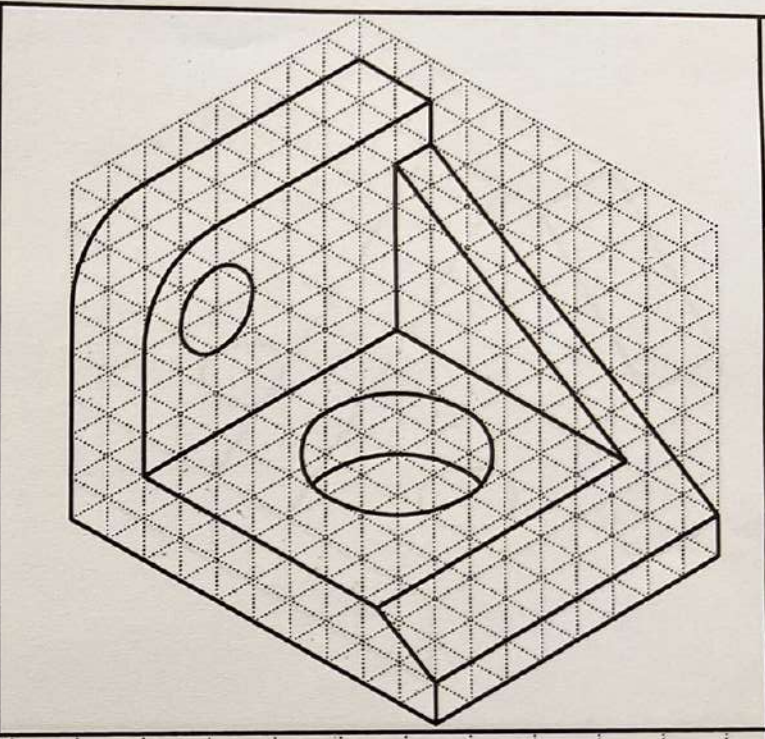
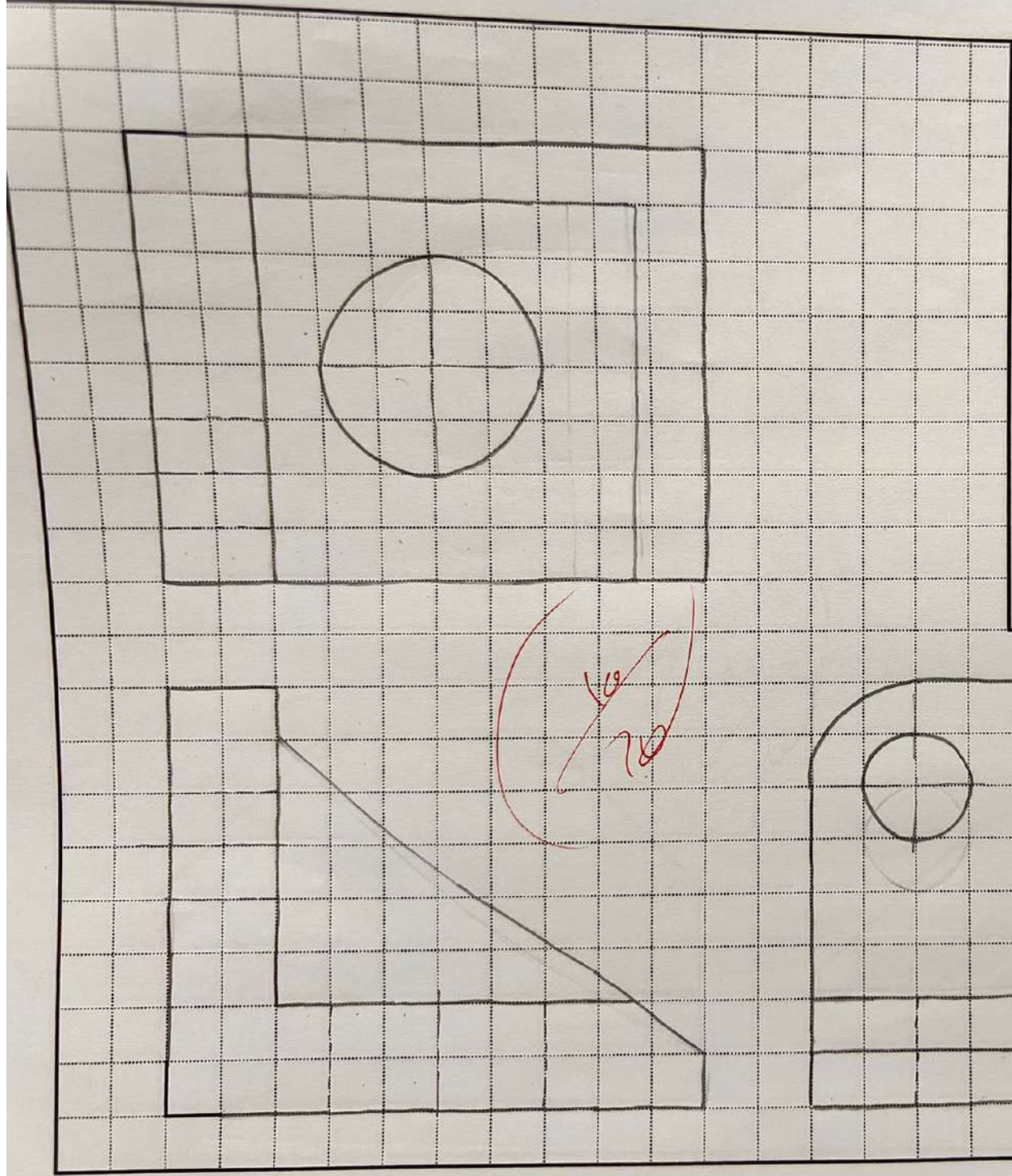

Name: _____ ID: _____ Sec: _____

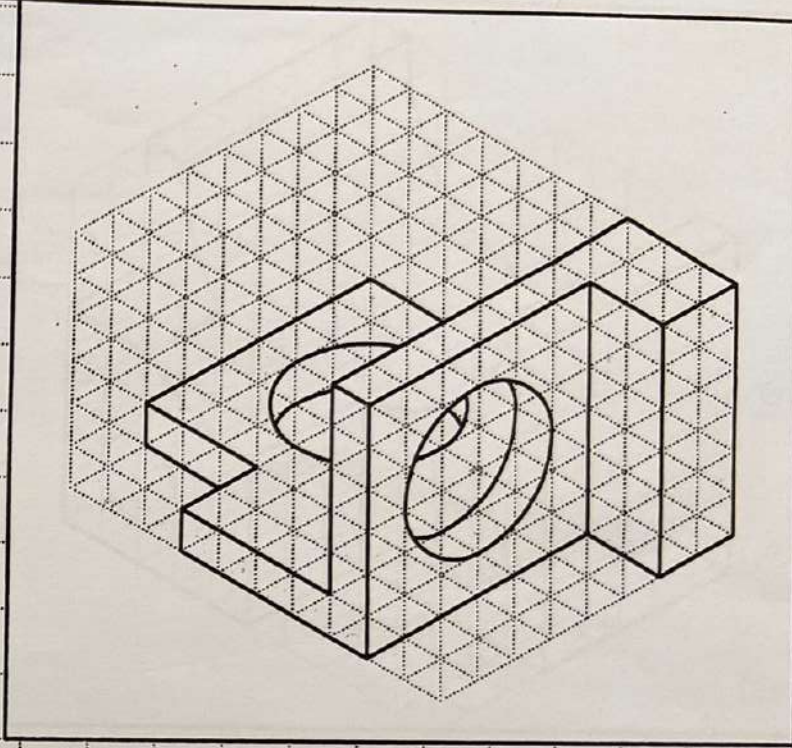
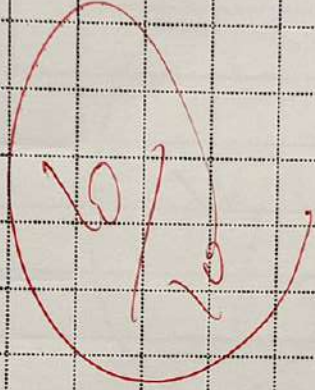
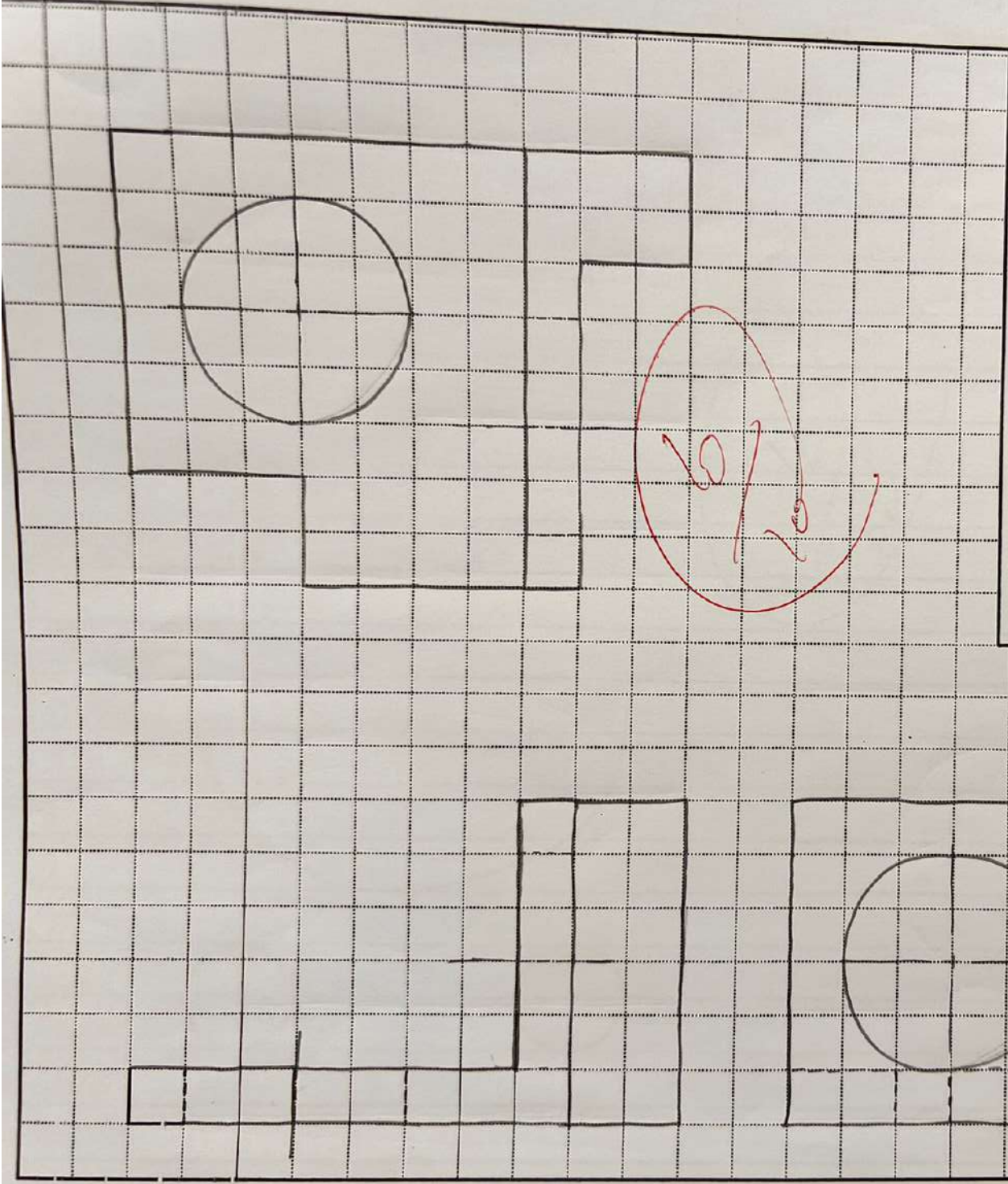

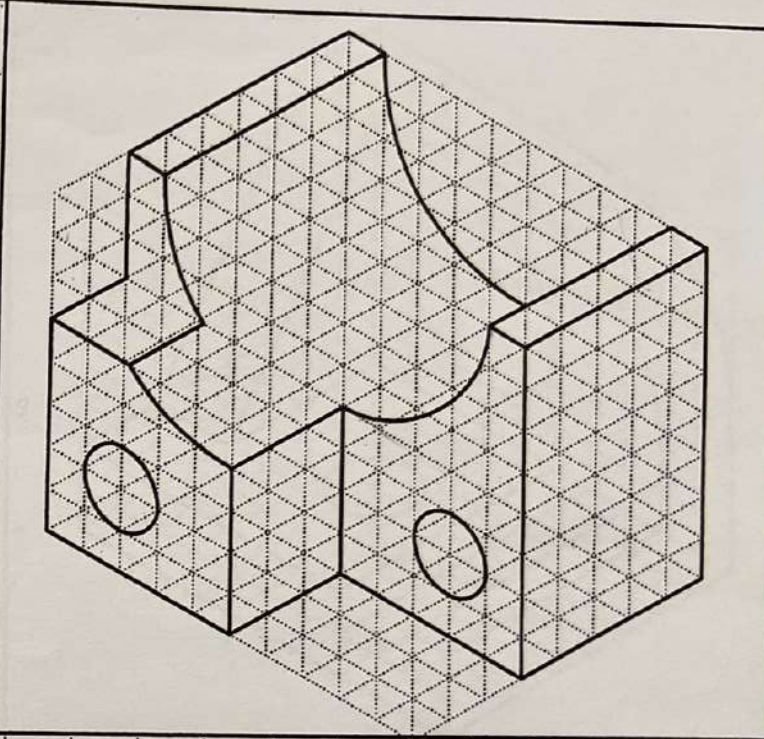
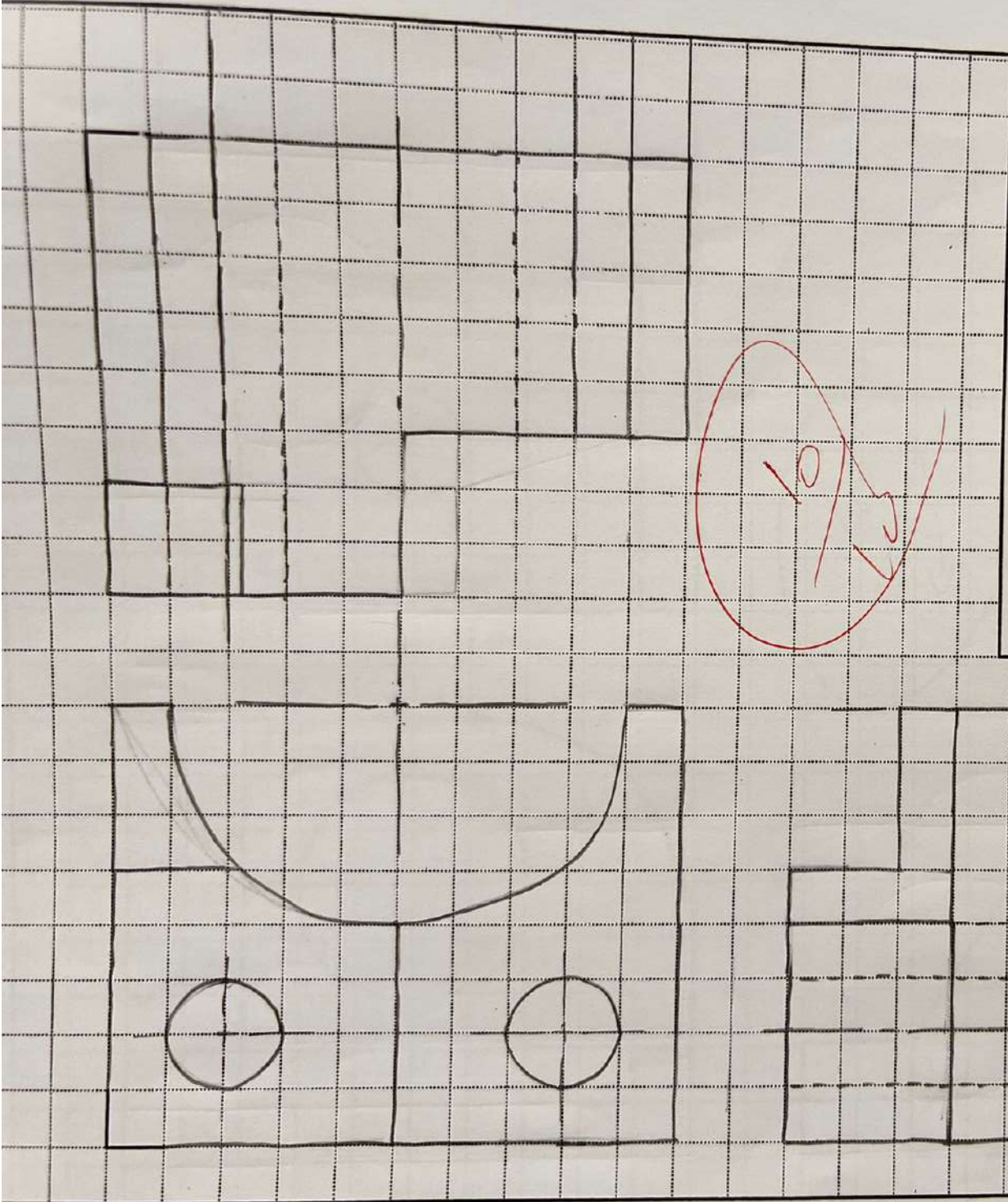

Name: YASMIN

ID: 1220848

Sec: IIM

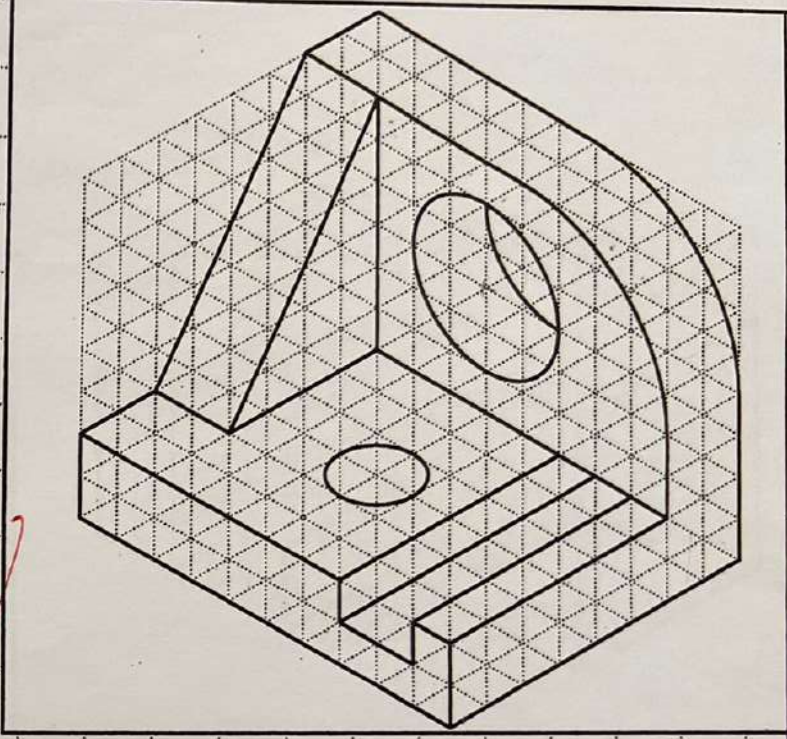
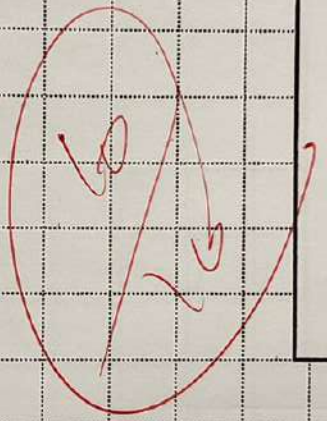
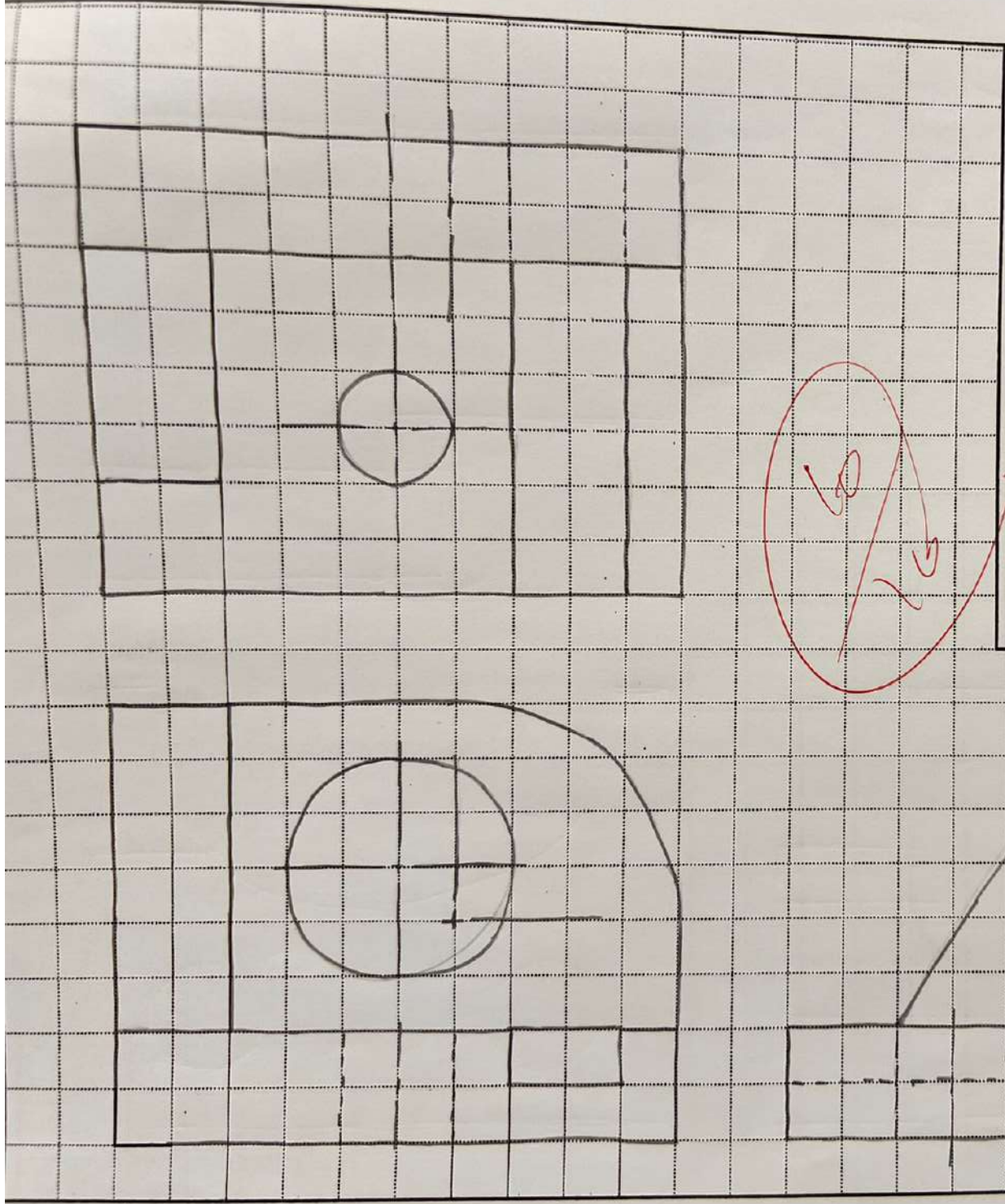

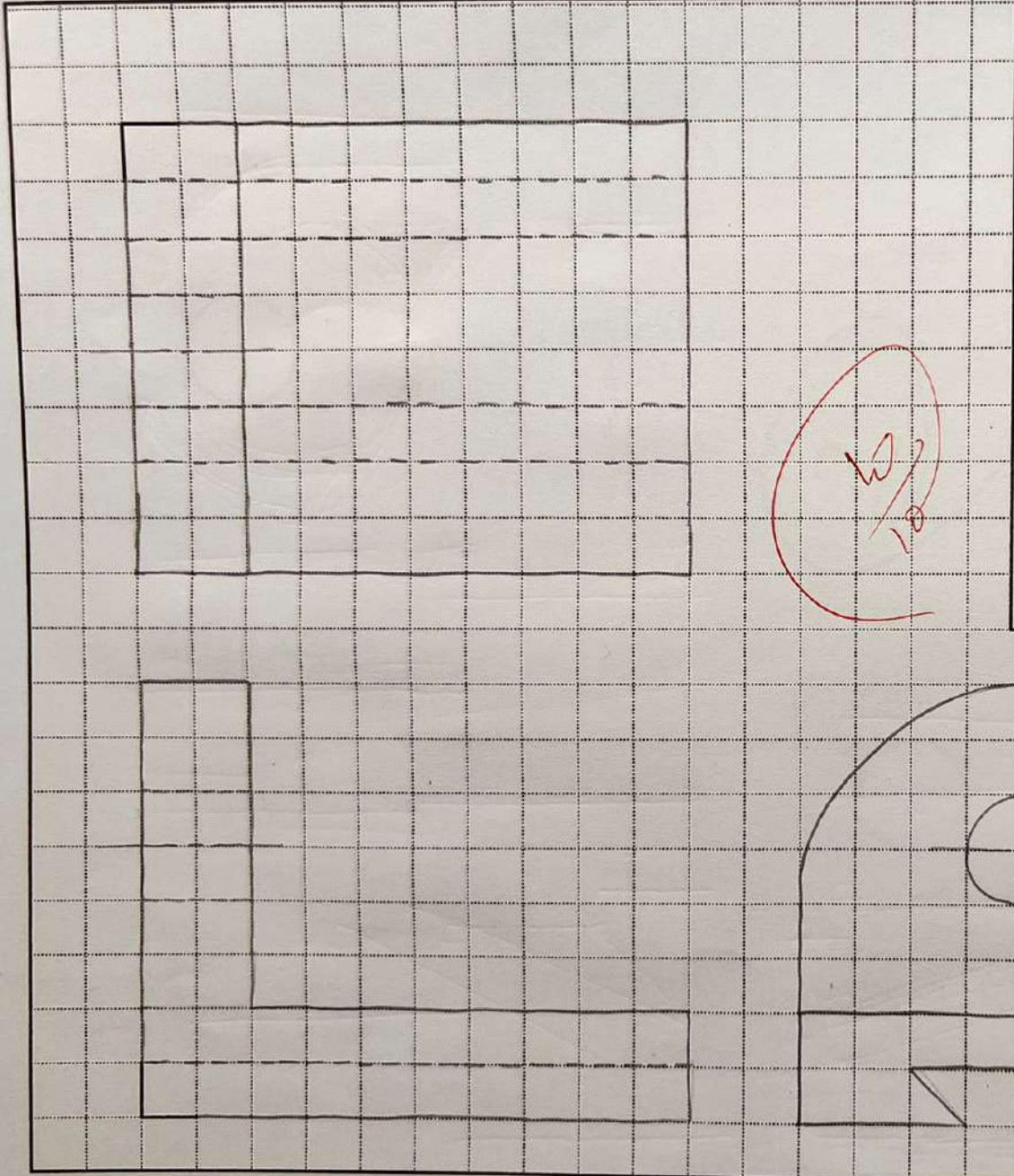

10/10

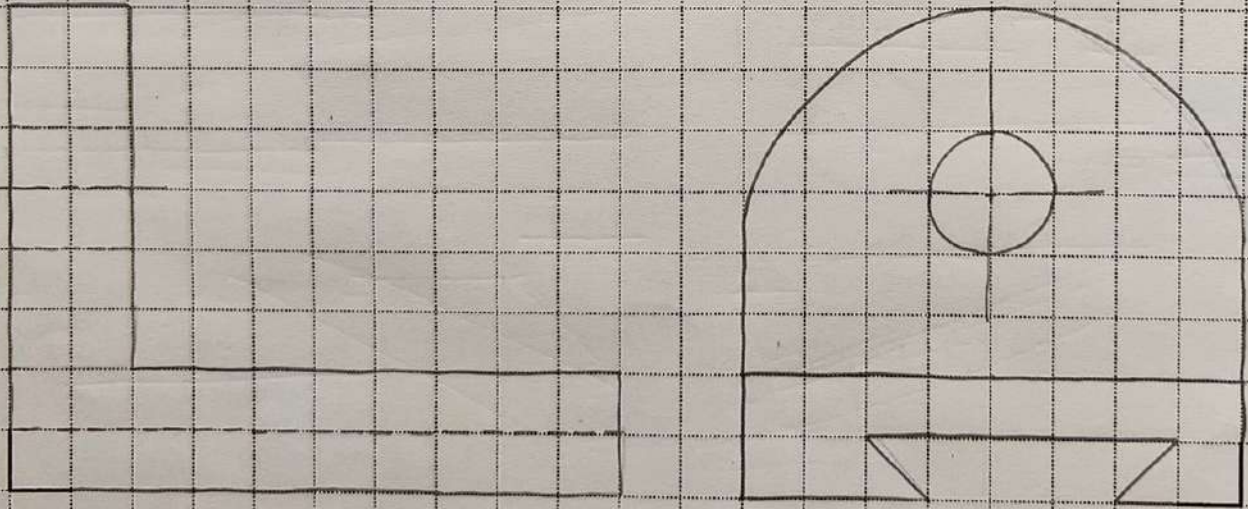
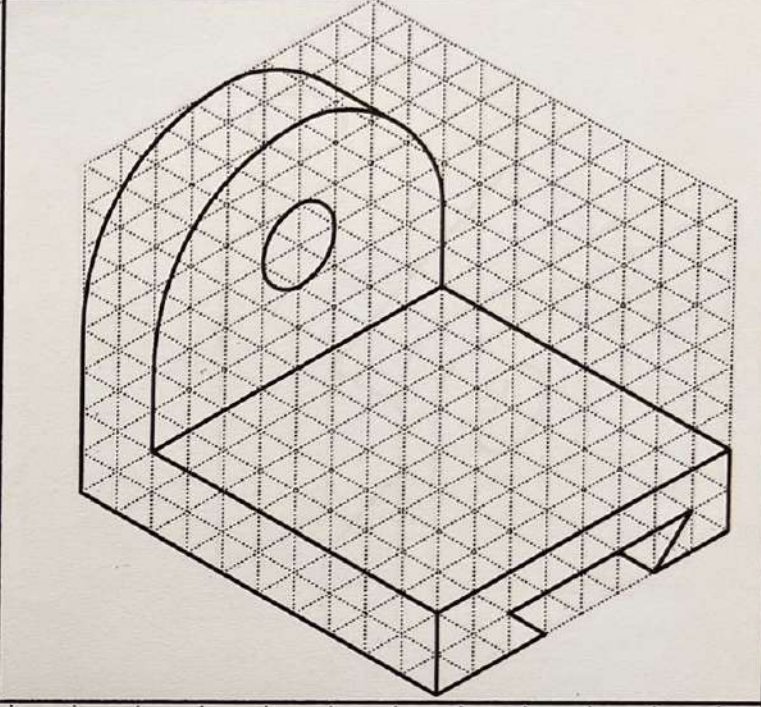

Name: YASMIN

ID: 1220848

Sec: ILM

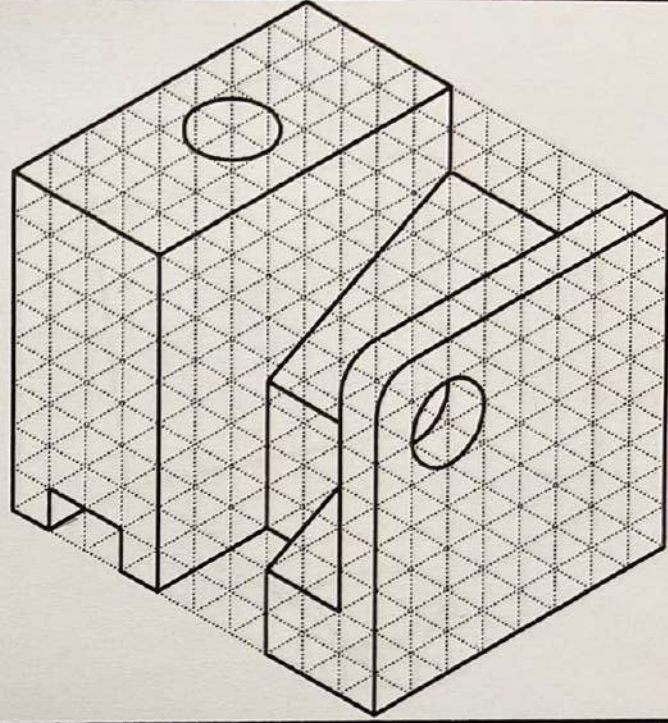
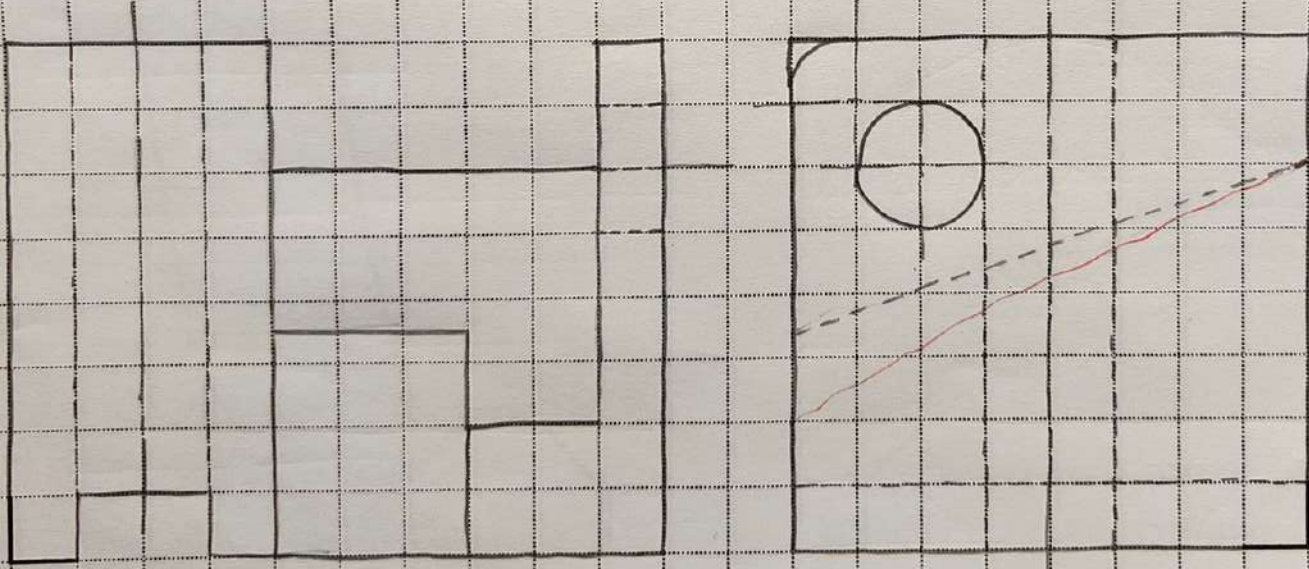
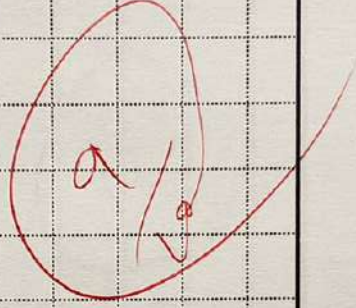
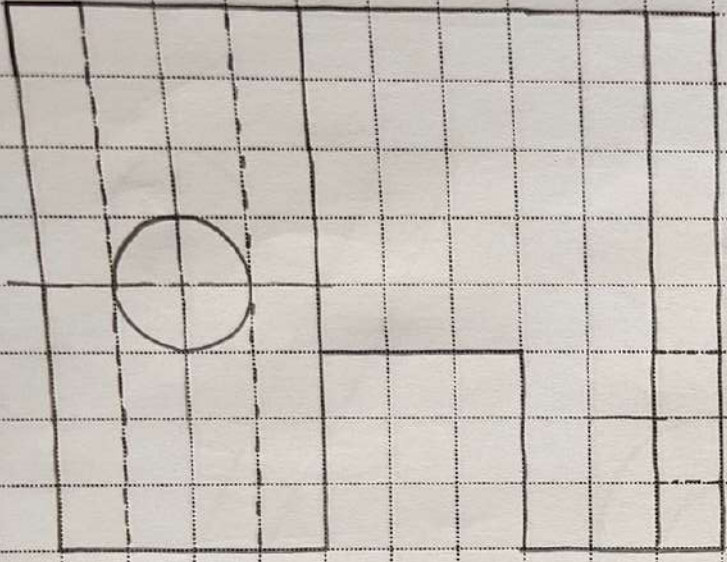

Name:

ID:

Sec:

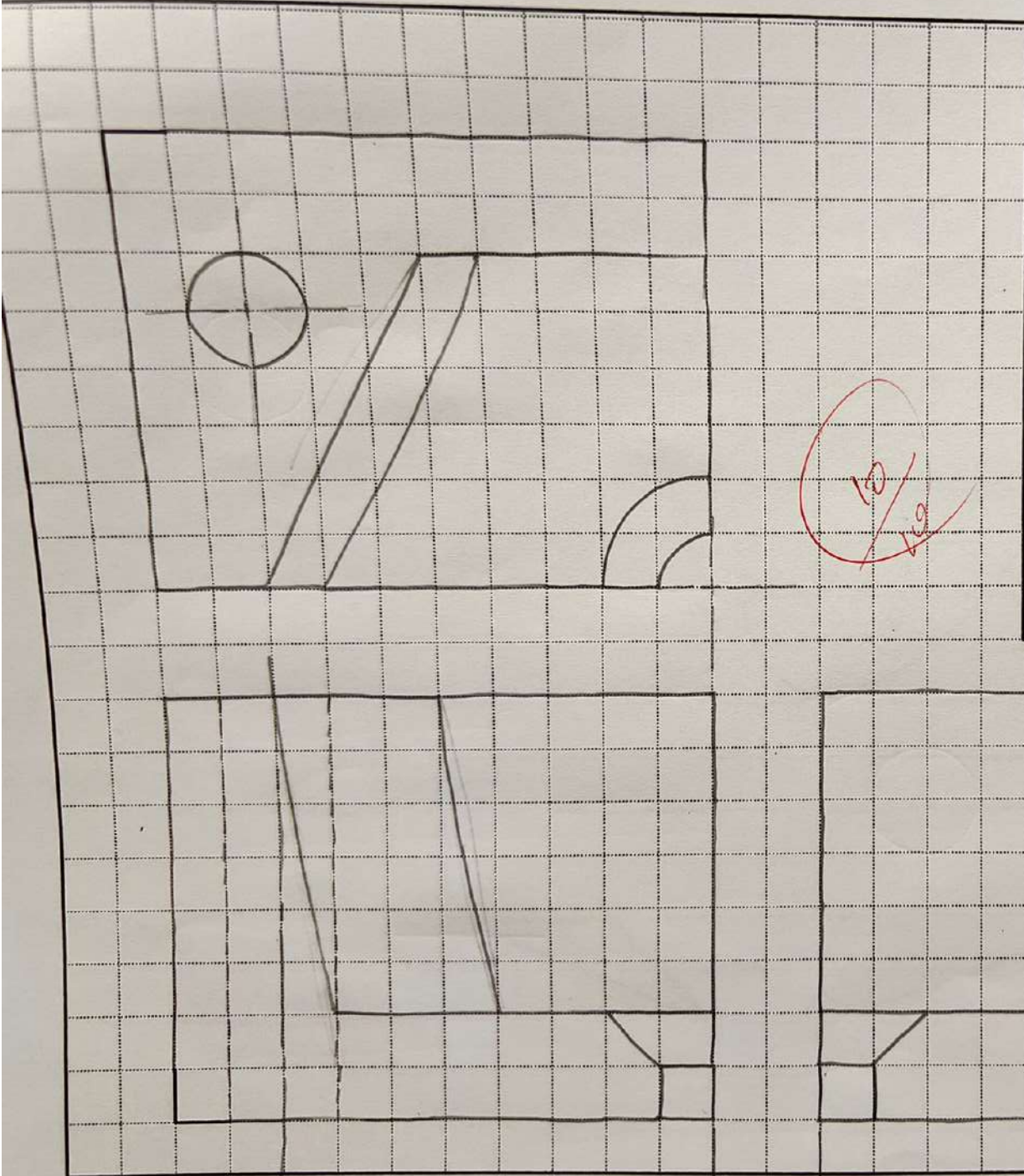

10/10

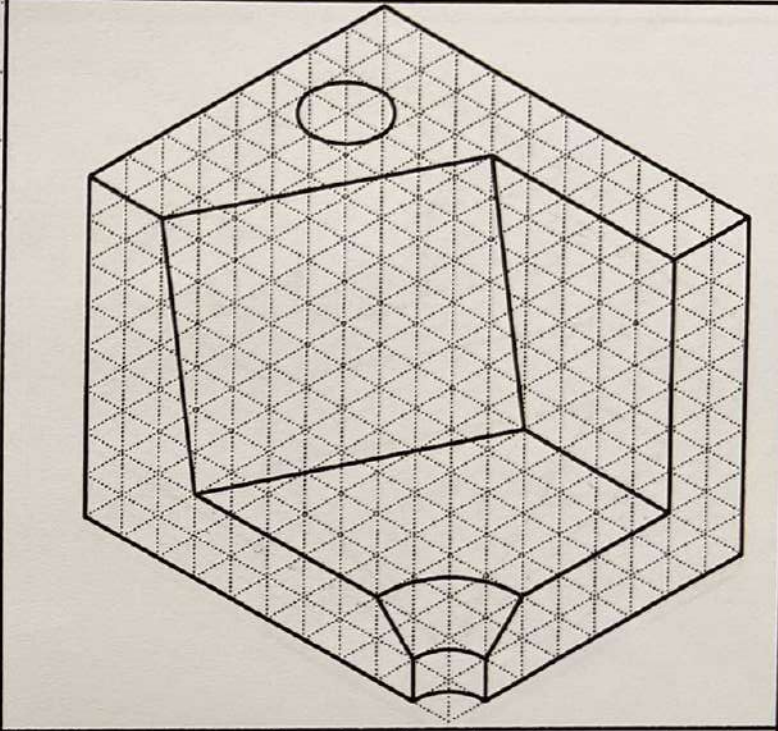

Name:

ID:

Sec:

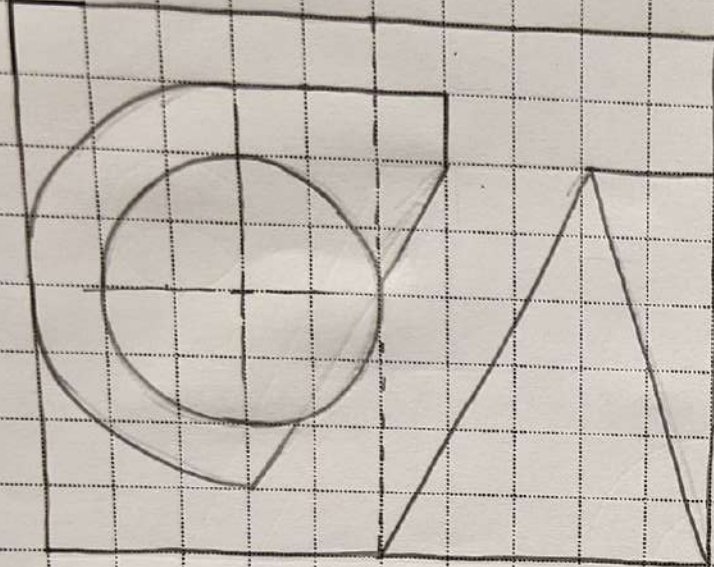

10/10

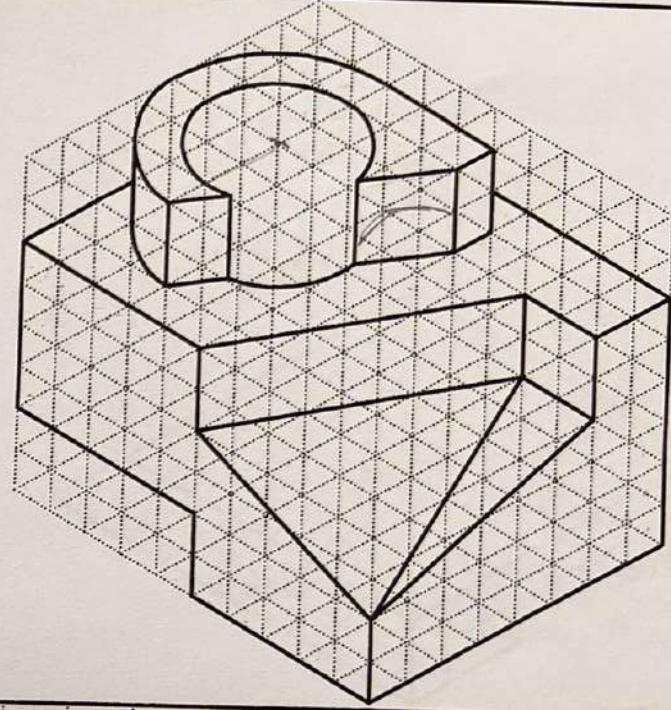
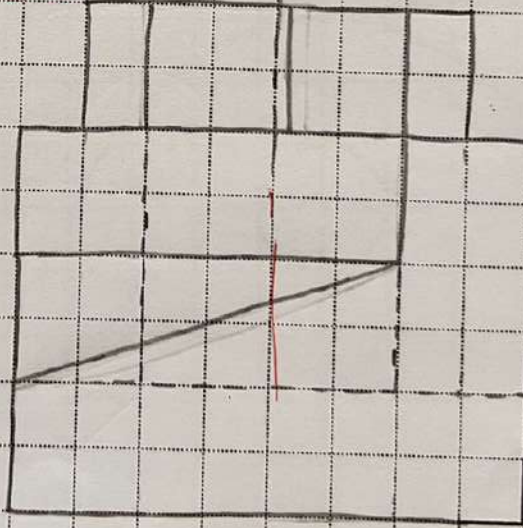
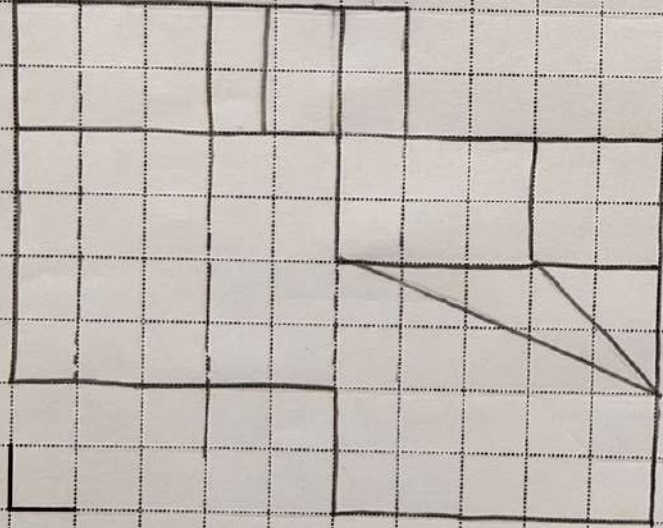

Name:

ID:

Sec:

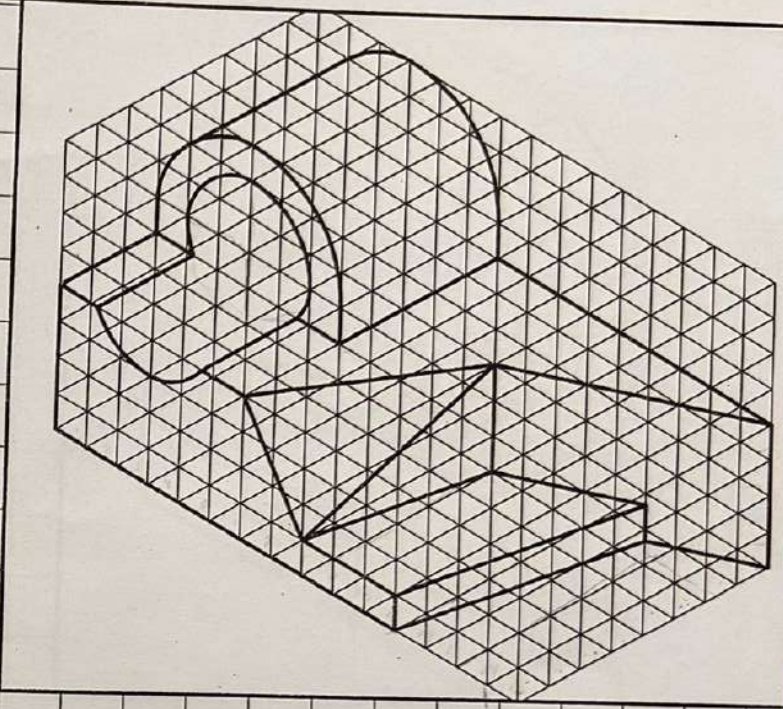
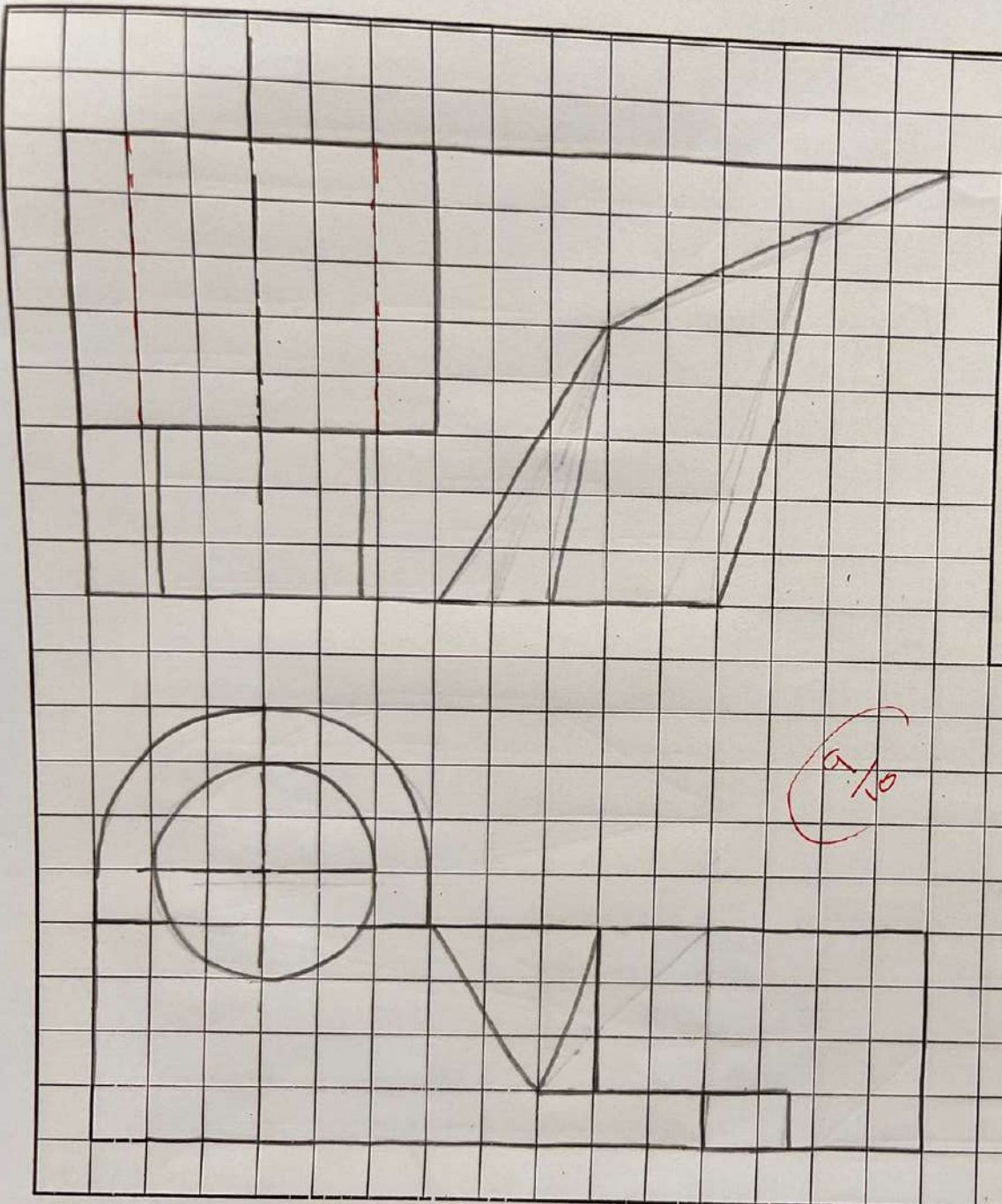

Name: YASMIN

ID: 1220848

Sec: IIM

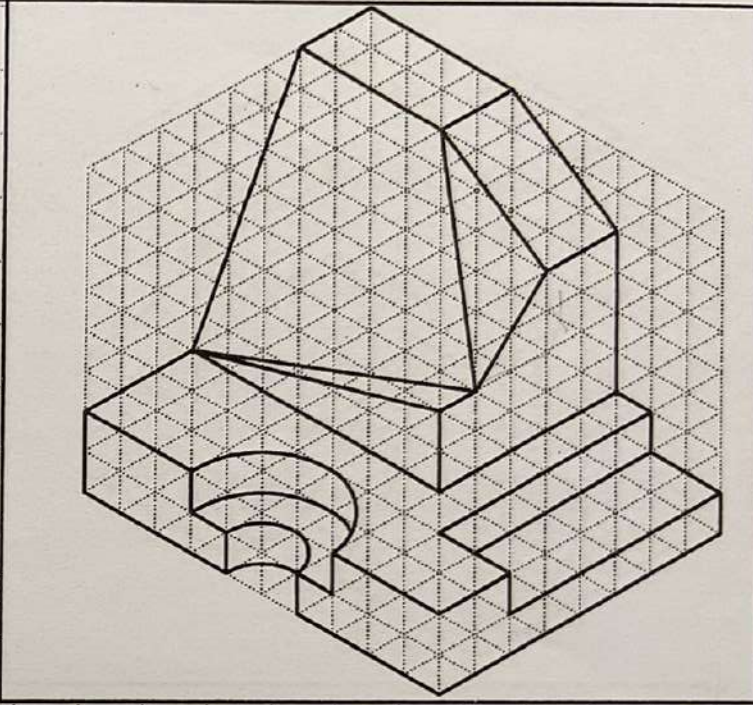
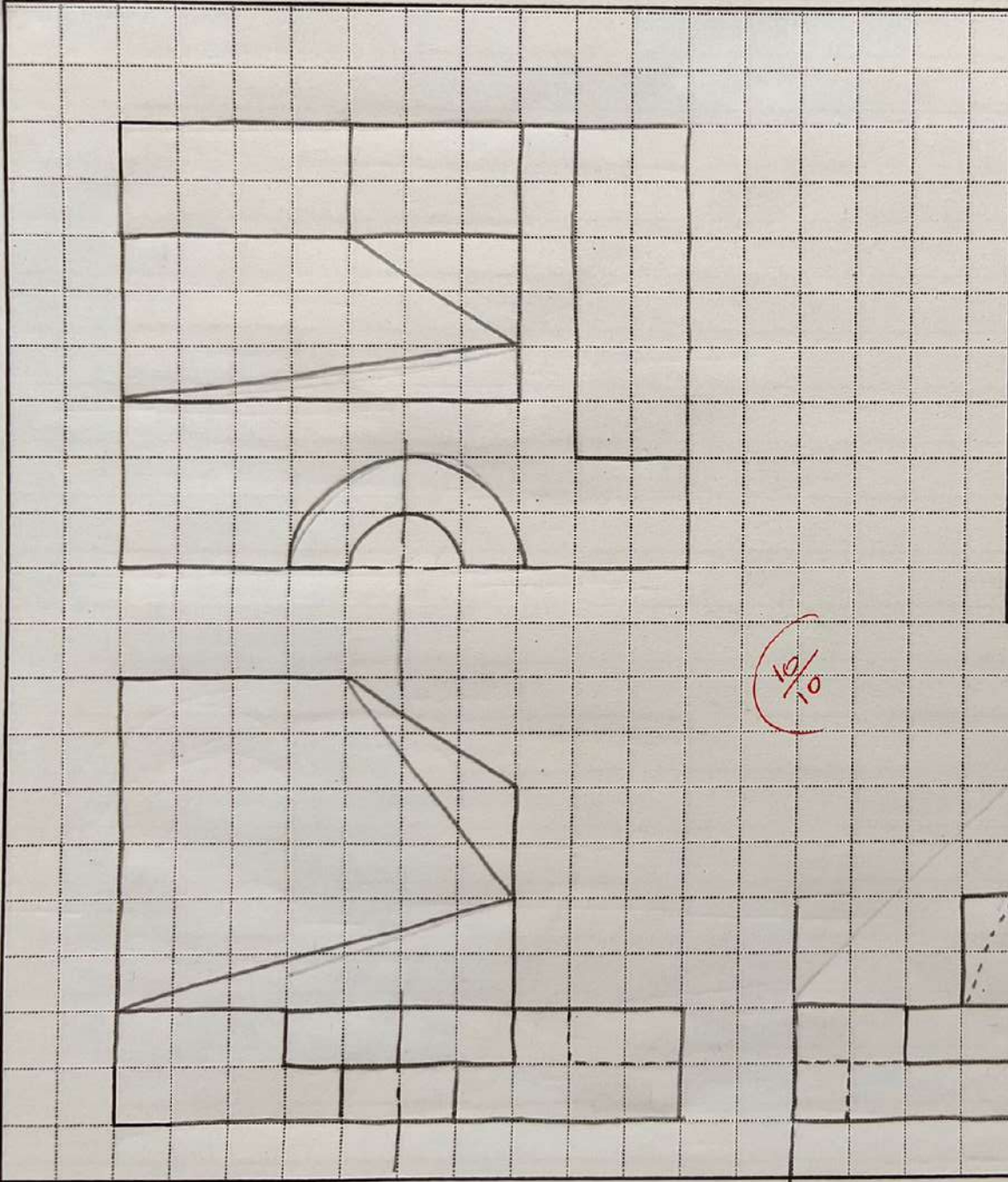

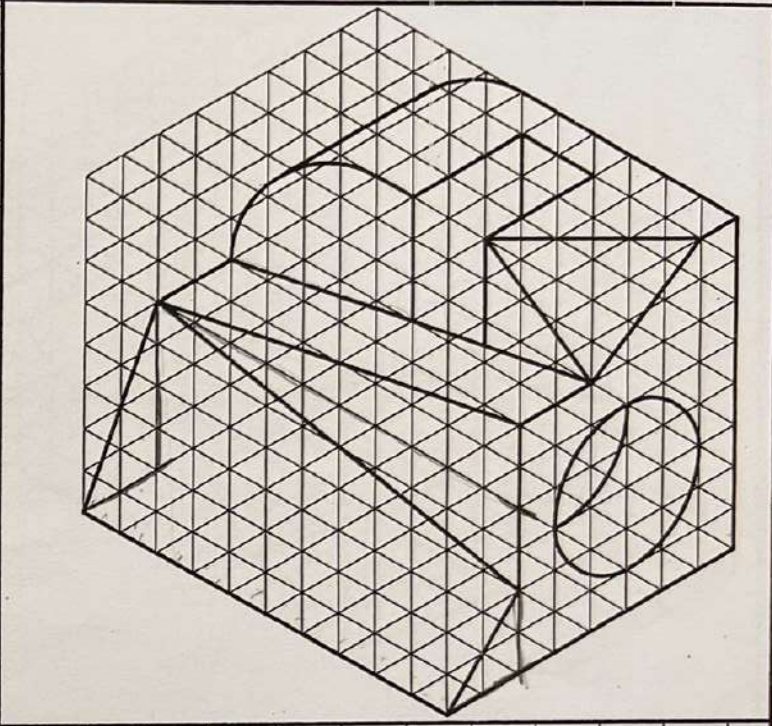
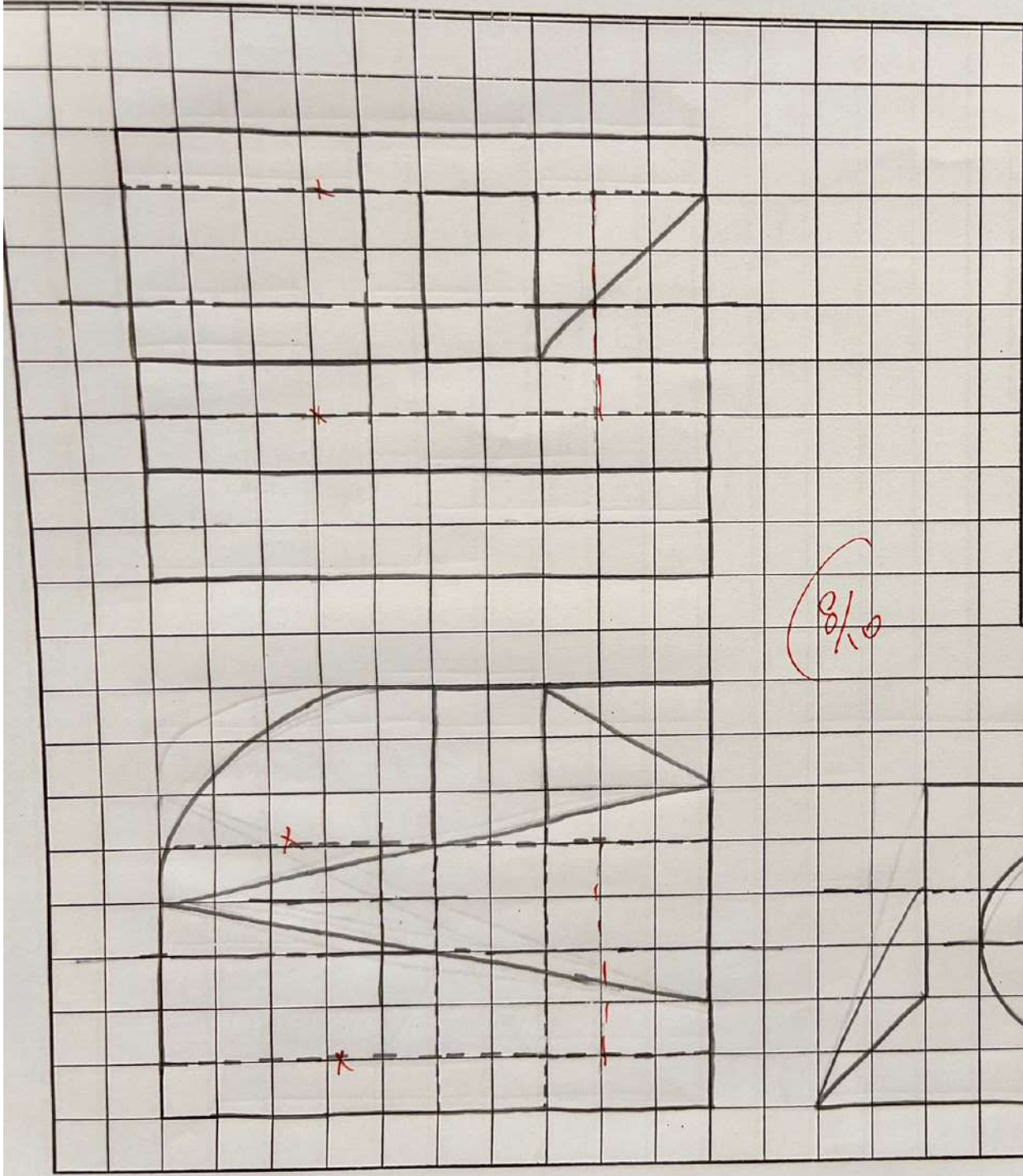

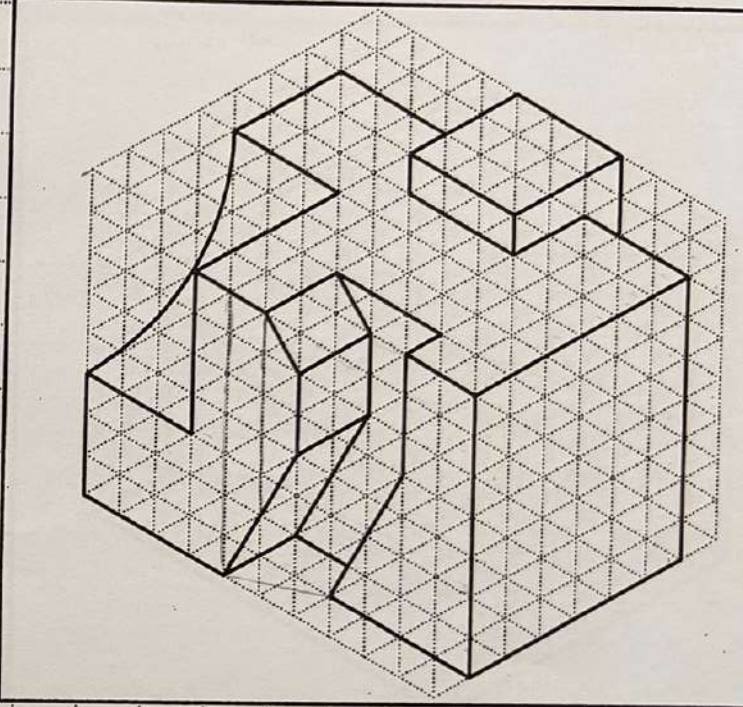
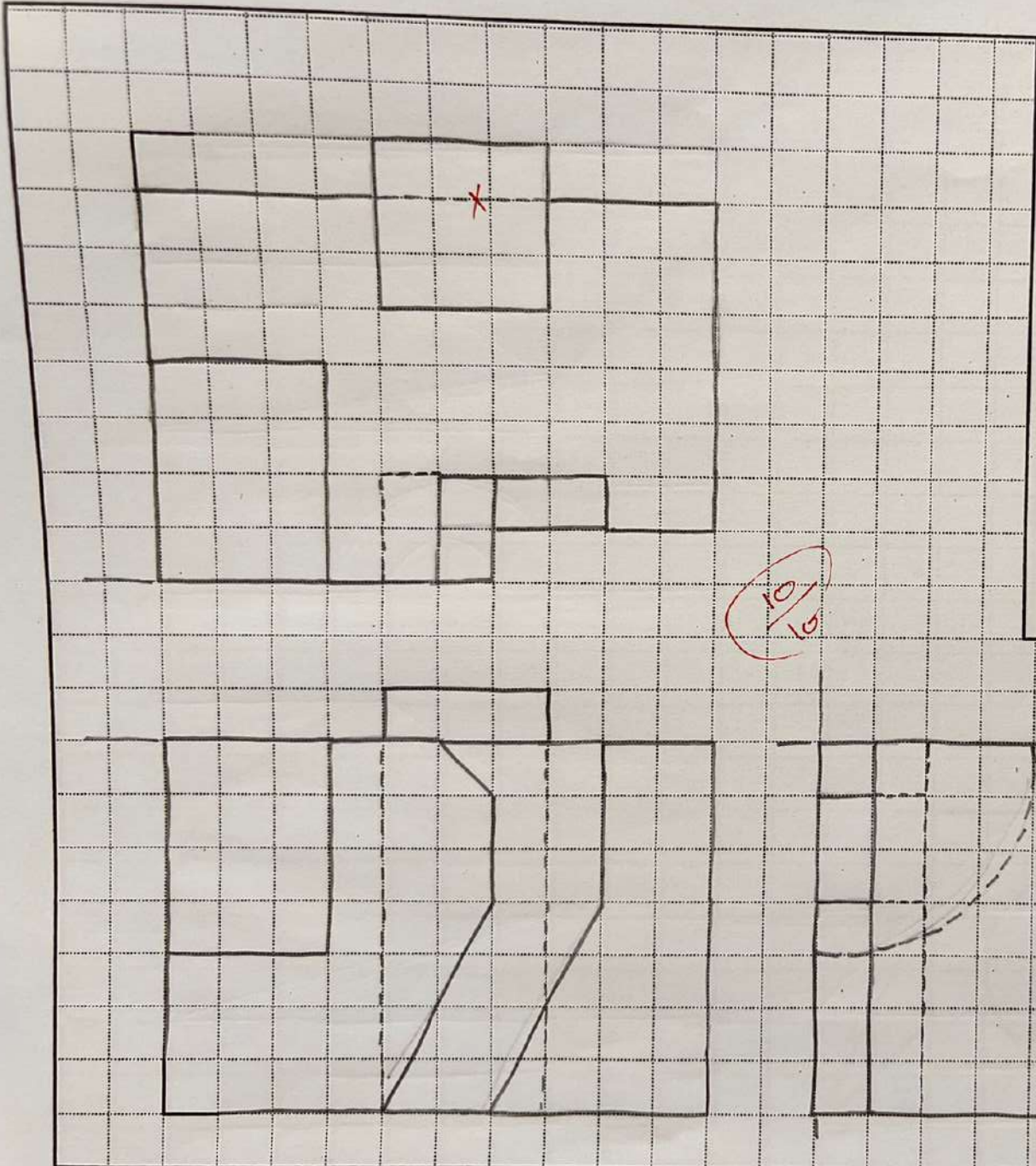

Name: YASMIN DARAWI

ID: 1220848

Sec: TIM